

# electronics

OCTOBER • 1956

A MCGRAW-HILL PUBLICATION • PRICE 75 CENTS

10/1

Packaged  
Four-Transistor  
Amplifier

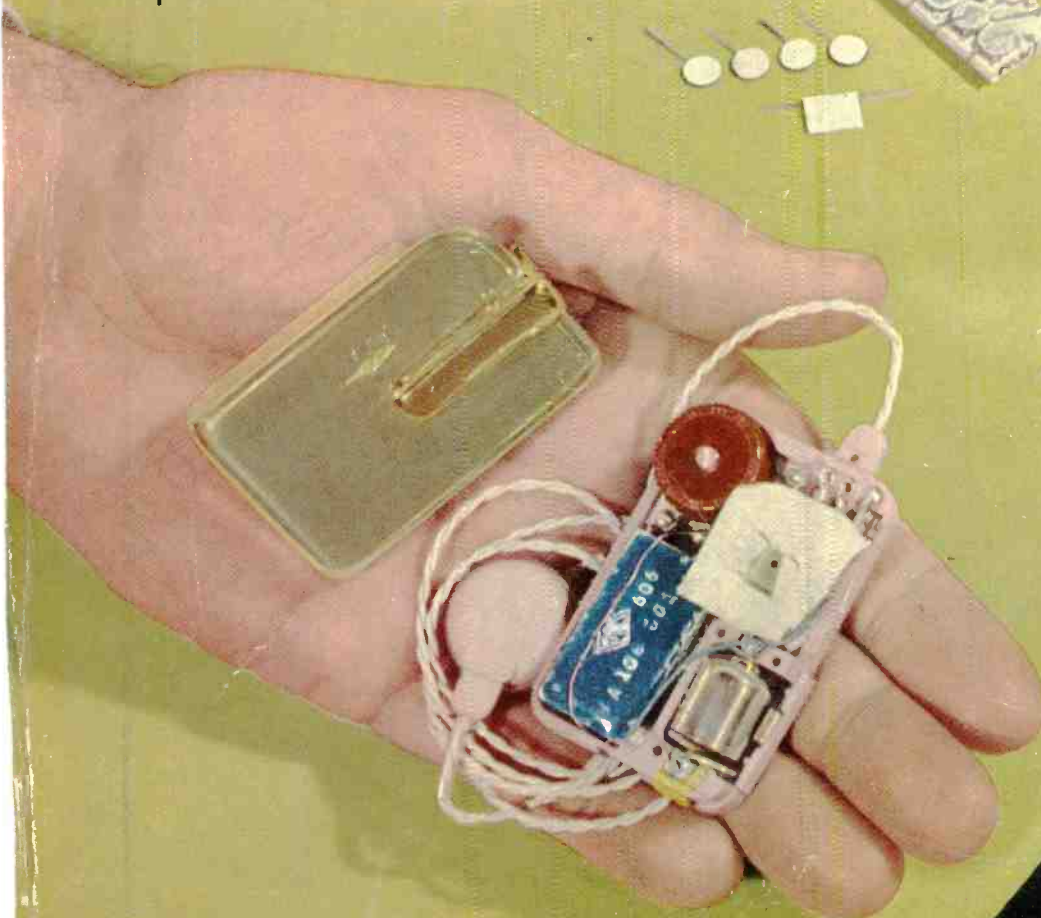

In  
This  
Issue

32 Page  
Report on  
**MATERIALS**



# DOTS

## Deci-Ouncer Transformers

### REVOLUTIONARY TRANSISTOR TRANSFORMERS

of unequalled power handling capacity and reliability

#### TYPICAL DOT PERFORMANCE CURVES

Power curves based on setting output power at 1 KC, then maintaining same input level over frequency range.

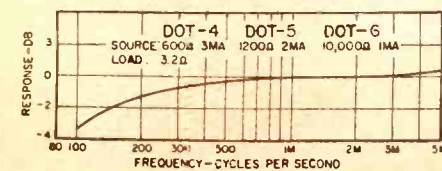
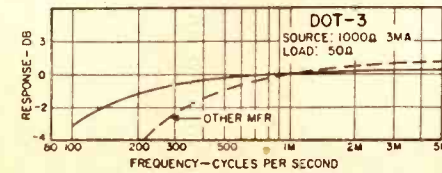
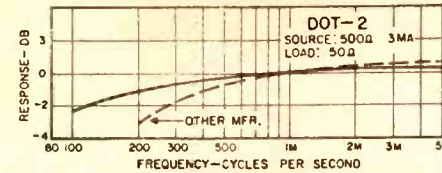
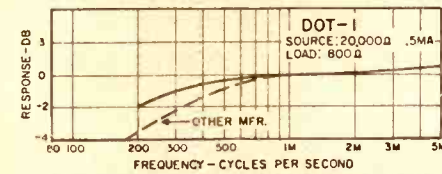
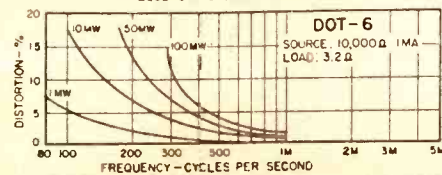
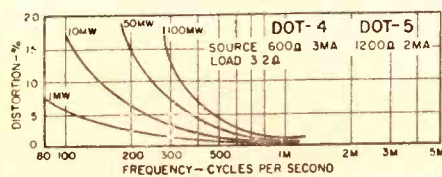
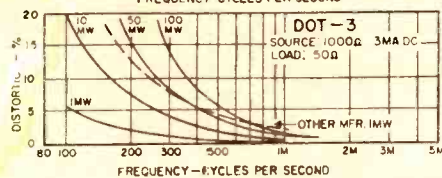
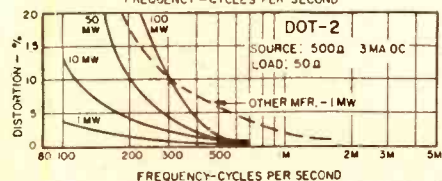
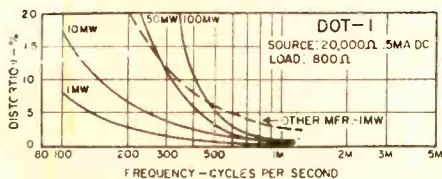

Conventional miniaturized transistor transformers have inherently poor electrical characteristics, perform with insufficient reliability and are woefully inadequate for many applications. The radical design of the new UTC DOT transistor transformers provides unprecedented power handling capacity and reliability, coupled with extremely small size. Twenty-two stock types cover virtually every transistor application. Special types can be made to order.

**High Power Rating** . . . up to 100 times greater.

DOT-1 has 5% distortion at 100 mw, other mfr. 6% at 1 mw.

**Excellent Response** . . . twice as good at low end.

DOT-3 is down 1 db at 200 cycles, other mfr. is down 4 db.

**Low Distortion** . . . reduced 80%.

DOT-1 shows 3% distortion where other mfr. shows 20%.

**High Efficiency** . . . up to 30% better.

DOT-1 has 850 ohm pri. resistance, 125 ohm sec.; other mfr. approx. 1200 and 200.

**Moisture Proof** . . . processed to hermetic specs.

DOT units are hermetic sealed compared to other mfr. open structures.

**Rugged** . . . completely cased.

DOT units can withstand all mechanical stresses.

**Anchored leads** . . . will withstand 10 pound pull test.

Lead strain completely isolated from coil winding.

**Printed Circuit Use** . . . plastic insulated leads at one end.

Other variations available.

1.3X ACTUAL SIZE



#### DOT CASE

Diameter . . . . . 5/16"  
Length . . . . . 13/32"  
Weight . . . . . 1/10 OZ.

Type No.	Application	Level Mw.	Pri. Imp.	D.C. Ma.± in Pri.	Pri. Res.	Sec. Imp.
DOT-1	Interstage	50	20,000 30,000	.5 .5	850	800 1200
DOT-2	Output	100	500 600	3 3	60	50 60
DOT-3	Output	100	1000 1200	3 3	115	50 60
DOT-4	Output	100	600	3	60	3.2
DOT-5	Output	100	1200	2	115	3.2
DOT-6	Output	100	10,000	1	1000	3.2
DOT-7	Input	25	200,000	0	8500	1000
DOT-8	Reactor 3.5 Hys. @ 2 Ma. DC				630	
DOT-9	Output or driver	100	10,000 12,500	1 1	930	500 CT 600 CT
DOT-10	Driver	100	10,000 12,500	1 1	930	1200 CT 1500 CT
DOT-11	Driver	100	10,000 12,500	1 1	930	2000 CT 2500 CT
DOT-12	Single or PP output	500	150 CT 200 CT	10 10	11	12 16
DOT-13	Single or PP output	500	300 CT 400 CT	7 7	20	12 16
DOT-14	Single or PP output	500	600 CT 800 CT	5 5	43	12 16
DOT-15	Single or PP output	500	800 CT 1070 CT	4 4	51	12 16
DOT-16	Single or PP output	500	1000 CT 1330 CT	3.5 3.5	71	12 16
DOT-17	Single or PP output	500	1500 CT 2000 CT	3 3	108	12 16
DOT-18	Single or PP output	500	7500 CT 10,000 CT	1 1	505	12 16
DOT-19	Output to line	500	300 CT	7	19	600
DOT-20	Output or matching to line	500	500 CT	5.5	31	600
DOT-21	Output to line	500	900 CT	4	53	600
DOT-22	Output to line	500	1500 CT	3	86	600

±DCMA shown is for single ended usage (under 5% distortion—100MW—1KC) . . . for push pull, DCMA can be any balanced value taken by .5W transistors (under 5% distortion—500MW—1KC)

## UNITED TRANSFORMER CO.

150 Varick Street, New York 13, N. Y. • EXPORT DIVISION: 13 E. 40th St., New York 16, N. Y.

CABLES: "ARLAB"

\*DOT units have been designed for transistor applications only . . . not for vacuum tube service \*\*Pats. Pending

A MCGRAW-HILL PUBLICATION

H. W. MATEER, *Publisher*

W. W. MacDONALD, *Editor*

VIN ZELUFF, *Managing Editor*

JOHN MARKUS, *Associate Editor*

ALEXANDER A. MCKENZIE, *Associate Editor*

JOHN M. CARROLL, *Associate Editor*

JOHN M. KINN, JR., *Associate Editor*

WILLIAM P. O'BRIEN, *Assistant Editor*

WILLIAM G. ARNOLD, *Assistant Editor*

DAVID A. FINDLAY, *Assistant Editor*

HAIG A. MANOOGIAN, *Assistant Editor*

GLORIA J. FILIPPONE, *Editorial Assistant*

ARLENE SCHILP, *Editorial Assistant*

BERNICE DUFFY, *Editorial Assistant*

BARBARA HEARST, *Editorial Assistant*

GLADYS T. MONTGOMERY, *Washington Editor*

HARRY PHILLIPS, *Art Director*

WALLACE B. BLOOD, *Manager*

R. S. QUINT, *Buyers' Guide Manager*

FRANK H. WARD, *Business Manager*

GEORGE E. POMEROY, *Classified Manager*

JEAN W. HEIGES, *Research*

DONALD H. MILLER, *New York*

JAMES GIRDWOOD, *New York*

MARTIN J. GALLAY, *New York*

WM. S. HODGKINSON, *New England*

JAMES T. HAUPTLI, *Philadelphia*

CHARLES WARDNER, *Chicago*

BRUCE WINNER, *Chicago*

WALTER M. LUCE, *Chicago*

HENRY M. SHAW, *Cleveland*

T. H. CARMODY, *San Francisco*

R. C. ALCORN, *San Francisco*

CARL W. DYSINGER, *Los Angeles*

R. H. POWELL, *Atlanta*

GORDON L. JONES, *Dallas*

DOUGLAS BILLIAN, *Dallas*

HERBERT LAGLER, *London*

KEITH HENNEY, *Consultant*

**PACKAGED FOUR-TRANSISTOR AMPLIFIER**—Germanium transistors, conductive silver wiring, printed resistors and ceramic capacitors are encased in ceramic wafer by mass-production methods at Centralab Milwaukee plant. Unit needs only output and volume control connections (see p 272) . . . COVER

SHOPTALK . . . . . 2

FIGURES OF THE MONTH . . . . . 8

INDUSTRY REPORT . . . . . 9

Missile Parts Take 500 C. . . . .	9	Broadcast Wages Up . . . . .	20
Tape Maker Enters Recording . . . . .	10	Military Electronics . . . . .	22
Industry's Defense Business . . . . .	10	Transistor Set Fits Pocket . . . . .	22
Computer Stores More Digits . . . . .	12	Tube Business Volume Up . . . . .	24
U. S. Reports To Double . . . . .	12	Canadian Electronics Grows . . . . .	24
Business Briefs . . . . .	14	FCC Actions . . . . .	26
Bomber's Electronics Grows . . . . .	14	Isotopes Boost Sales . . . . .	26
TellerVision Takes Deposits . . . . .	16	Solids Lure Physicists . . . . .	28
Auto Radios Use Transistors . . . . .	16	VORTAC Decision Made . . . . .	28
CAA Buys More Radar . . . . .	18	Financial Roundup . . . . .	28
Color TV Sales Picture . . . . .	18	Movies Use Electronics . . . . .	30
Airliners Avoid Weather . . . . .	20	Meetings Ahead . . . . .	30
Industry Shorts . . . . .	30		

CROSSTALK . . . . . 151

## FEATURES

**Taking The Heat Off Miniature Equipment** . . . . . 152

By James P. Welsh

**Three-Phase Detector for Color-TV Receivers** . . . . . 157

By A. A. Goldberg

**Transistor-Magnetic Analog Multiplier** . . . . . 160

By Glenn L. Keister

**Transmitting System Uses Delta Modulation** . . . . . 164

By R. B. Watson and O. K. Hudson

**Magnetic-Switch B-H Loop Tracer** . . . . . 167

By William Geyger

**Radar Simulator for Laboratory Use** . . . . . 170

By Henry J. Bickel and Robert I. Bernstein

**Transistors and Diodes Stabilize A-C Servos** . . . . . 174

By R. Gittleman

**Tantalum Capacitors Use Solid Electrolyte** . . . . . 176

By David A. McLean

Photoelectric Analog Function Generator .....	178
By Robert A. Sinker	
Carrier Telephone Expands Rural Service .....	182
By James E. MacDowell and H. J. B. Nevitt	
<b>MATERIALS for ELECTRONICS—Special Report</b> .....	185
By John Markus and David A. Findlay	
Transistorized Receiver for Vehicular Radio .....	217
By Seymour Schwartz	
Phase Generator for Tropospheric Research .....	220
By R. W. Hubbard and M. C. Thompson, Jr.	
Gain Chart for Transistor Amplifiers (Reference Sheet) .....	224
By George H. Myers	

## ELECTRONS AT WORK..... 228

Slow-Scan TV .....	228	Direct Readout Velocity Meter.....	246
Three-Band Storm Radars .....	230	By Howard W. Snyder	
High-Temperature Tetrode .....	230	PBX Blind Eye .....	246
Transistors For UHF .....	230	Magnetic Flow Meters .....	252
Wave-Modulated Oscilloscope .....	232	By G. E. Wetmore	
Electronics Defends B-52 .....	232	Miniaturized Amplifier .....	254
White Alice Uses Scatter .....	234	High Gain Microphone .....	260
SAGE Air Defense Computer .....	234	Dial Controls Drill .....	264
Transistors Cut Camera Size .....	238	Receiver Calibrates Monitors .....	266
Nonmicrophonic Klystron .....	238	By Robert D. Lambert, Jr.	
Voltage Tunable Magnetron .....	244	Airborne Video .....	268
		Controlled Diode Breakdown .....	270

## PRODUCTION TECHNIQUES..... 272

COVER: Transistor Amplifier.....	272	Straps Catch Fluorescent Tubes.....	290
Germanium Crystal Grower.....	274	Tuning Capacitor Soldering.....	292
Stick Holder for Coil Winder.....	276	Contour Projector for Beam Tubes.....	294
Guard Improves Toroid Winder.....	278	Gelatin Mats Clean Shoes.....	300
Testing Transistors in Production.....	278	Dip-Soldering Tuner Wafers.....	302
Checking Stator Plate Thickness.....	280	Thickness Gage for Blind.....	304
Building Wire Harnesses.....	282	Capacitor Pitch and Roll Test.....	306
By George Schuplin		Exhaust for Power Magnetrons.....	314

## NEW PRODUCTS..... 322

## LITERATURE..... 403

## PLANTS AND PEOPLE..... 422

## NEW BOOKS..... 451

## THUMBNAIL REVIEWS..... 460

## BACKTALK..... 462

## INDEX TO ADVERTISERS..... 525

# SHOP

► **SPEED** . . . We've increased the number of editorial pages in **ELECTRONICS** this year and one result has been publication of featured technical articles in about half the time expected of engineering publications (though still not fast enough for impatient authors!).

Suggested manuscripts will be handled still faster from now on, but with no less attention to the details of presentation our readers have come to expect of us; we are expanding staff to meet growing industry needs.

► **EXTREME COOPERATION** — When writing an article, an editor tries to visualize the best illustrations to accompany the text. Some times he makes a crude drawing, perhaps showing how each photograph should appear.

Occasionally he gets the opportunity to direct the taking of the picture by one of our company photographers. More often he must remote control others and depend on them to use the best vantage point.

In the days when tv antennas were few and far between, one **ELECTRONICS** editor needed a photo for an article on multiplex antenna systems. He scouted New York City for a view of many antennas atop an apartment house. Finding a good setup, he got permission to take a picture from the roof of a nearby tall hotel.

Phoning the office, he arranged for one of our photographers to

# electronics

OCTOBER, 1956 Vol. 29, No. 10



Member ABC and ABP

# TALK

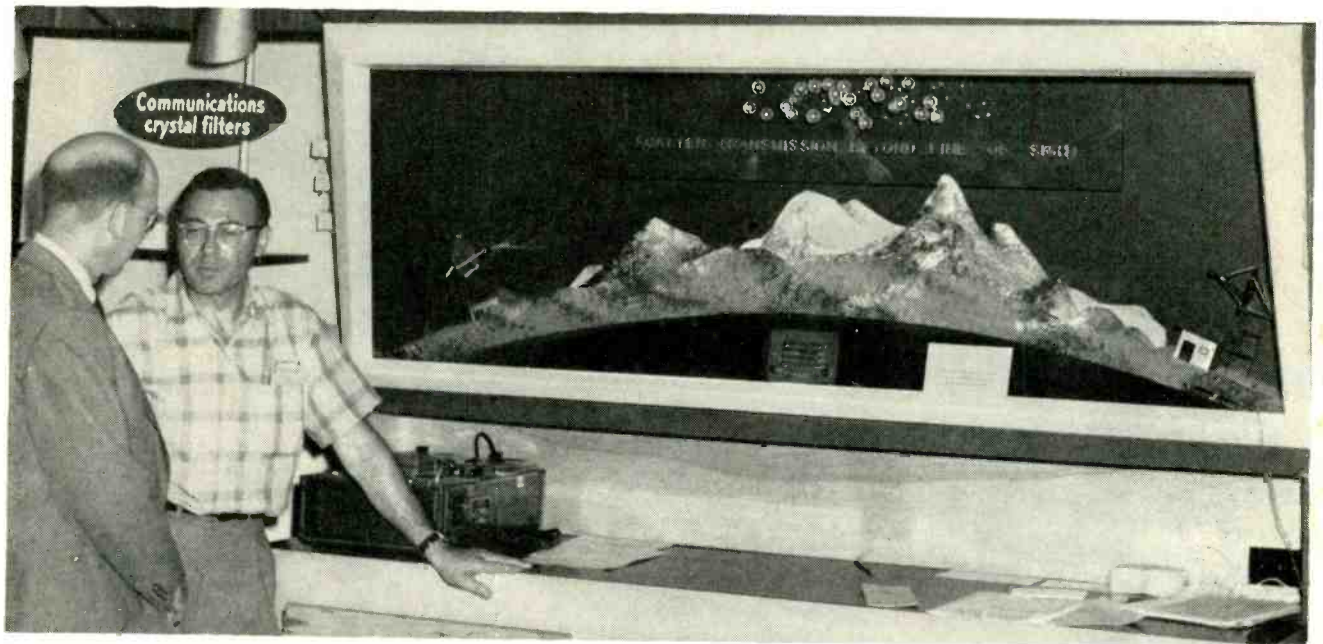

**FORWARD SCATTER** demonstration uses glass balls suspended by threads to refract a modulated light beam over a nonoptical path. When the ball assembly is removed, the music transmitted over the beam stops. A puff of smoke blown into the scatter point restores the circuit permitting signals to be received again

come up and take the photo. While waiting, he busied himself dragging a piece of timber that had been stored on the roof over to the edge.

When the photographer arrived, he solemnly informed him that he proposed to tie him to it and lever him out over the edge to the best vantage point . . . Minutes later, the picture was taken, but with a telephoto lens from a different point.

Recently, an editor requested that one electronics company take photographs of a certain sizable equipment. He received two shots, with the following note:

"Enclosed are a medium closeup showing two engineers at a portion of the equipment and a shot of the scale model to show its scope.

"We found that the only way to get a decent shot of the actual system in its present location was to chop a hole in the roof. If you'd like us to try again, however, we'll be glad to."

► **EDITOR AT WORK** — When Alex McKenzie left on a recent swing through electronics plants and laboratories in the west and southwest, he expected to see a lot of new faces. He did, but among

the thirty thousand engineers attending Wescon, he also encountered some old friends who had likewise traveled 3,000 miles from home offices and labs.

One of these was a chap he hadn't seen for a long time, although they live only a couple of hundred miles apart. Jack Memishian had been a radio engineer with Alex at Radiation Lab. MIT, during the war when they worked on the Loran project. Jack is now with Hycon Eastern and, at Wescon, helped enliven a demonstration of forward scatter by occasionally blowing cigarette smoke at the exhibit.

Published monthly with an additional issue in June by McGraw-Hill Publishing Company, Inc., James H. McGraw (1860-1948), Founder, Executive, Editorial and Advertising Offices: McGraw-Hill Building, 330 W. 42 St., New York 36, N. Y. Longacre 4-3000. Publication Office, 99-129 North Broadway, Albany 1, N. Y. Donald C. McGraw, President; Paul Montgomery, Executive Vice-President; Joseph A. Gerardi, Executive Vice-President and Treasurer; Hugh J. Kelly, Executive Vice-President; John J. Cooke, Secretary; Nelson Bond, Executive Vice-President, Publications Division; Ralph B. Smith, Vice-President and Editorial Director; Joseph H. Allen, Vice-President and Director of Advertising Sales; J. E. Blackburn, Jr., Vice-President and Circulation Director.

Subscriptions: Address correspondence to Electronics—Subscription Service, 330 W. 42nd St., New York 36, N. Y. Allow one month for change of address. Subscriptions are solicited only from persons engaged in theory, research, design, production, maintenance and use of electronic and industrial control components, parts and products. Position and company connection must be indicated on subscription orders.

Single copies 75¢ for United States and possessions, and Canada; \$1.50 for Latin America; \$2.00 for all other foreign countries. Buyers' Guide \$3.00. Subscription rates—United States and possessions, \$5.00 a year; \$9.00 for two years. Canada, \$10.00 a year; \$16.00 for two years. Other western hemisphere countries and the Philippines, \$15.00 a year; \$25 for two years. All other countries \$20.00 a year; \$30.00 for two years. Three-year rates, accepted on renewals only, are double the one-year rate. Entered as second-class matter August 20, 1936, at the Post Office at Albany, N. Y., under act of Mar. 3, 1879. Printed in U.S.A. Copyright 1956 by McGraw-Hill Publishing Co., Inc.—All Rights Reserved.

BRANCH OFFICES: 520 North Michigan Avenue, Chicago 11, Ill.; 68 Post Street, San Francisco 4; McGraw-Hill House, London, E. C. 4; National Press Bldg., Washington, D. C. 4; Architects Bldg., 17th & Sanson Sts., Philadelphia 3; 1510 Hanna Bldg., Cleveland 15; 856 Penobscot Bldg., Detroit 26; 3615 Olive St., St. Louis 8; 350 Park Square Bldg., Boston 16; 1321 Rhodes Hagerly Bldg., Atlanta 3, Ga.; 1125 West Sixth St., Los Angeles 17; 919 Oliver Building, Pittsburgh 23. ELECTRONICS is indexed regularly in The Engineering Index.

# **NOW-PORTABLE** **400 cycle power**

This new frequency changer makes it possible to provide well regulated 400 cycle power conveniently and quickly. This unit, Model FCR 250, is extremely useful in a wide variety of applications including testing, production, airborne frequency control, computers, missile guidance system testing, and in practically any application where the use of 400 cycle power is advantageous.

Model FCR 250 is only one of a complete line of frequency changers available from Sorensen . . . the authority on controlled power for research and industry. Write for complete information.

#### ELECTRICAL CHARACTERISTICS

Input	105-125 VAC, 1 phase, 50-65 cycles
Output voltage	115 VAC, adjustable 105-125V
Output Frequency	320-1000 cps in two ranges
Voltage regulation	$\pm 1\%$
Frequency regulation	$\pm 1\%$ ( $\pm 0.01\%$ with auxiliary frequency standard fixed at 400 cycles)
Load range	0-250 VA

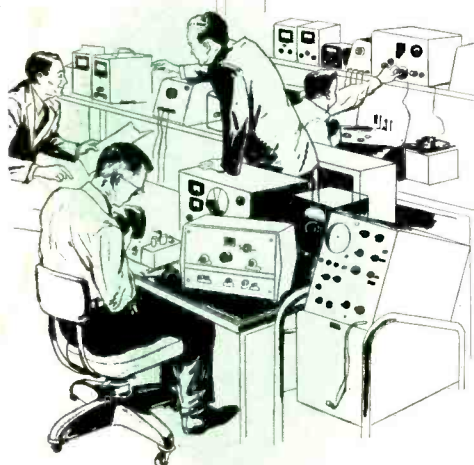

**MODEL FCR 250**

**SORENSEN & COMPANY, INC.**



**STAMFORD • CONN.**

*In Europe, contact Sorensen-Ardag, Eichstrasse 29, Zurich, Switzerland, for all products including 50 cycle, 220 volt equipment.*

# MUIRHEAD SYNCHROS

## EXACTLY to BuOrd Spec

### SIZE 11 115V 400c/s

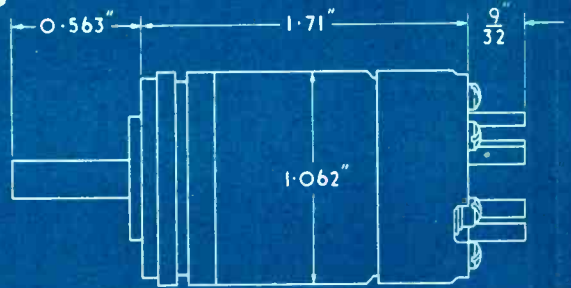

### MUIRHEAD

F11 M-1-A/1 SIZE 11 CONTROL TRANSMITTER

U. S. Bureau of Ordnance Number 11 CX 4a MARK 41 MOD. 1.

Supply 115V 400c/s

Nominal Rotor/Stator voltages 115/90V

#### MECHANICAL DATA

BEARINGS	Single row ball journal bearings	ACCURACY (MAXIMUM ELECTRICAL ERROR)	7 minutes
ROTOR CONNEXIONS	Silver strip brushes, Silver slip rings	MOMENT OF INERTIA OF ROTOR	0.014 oz in <sup>2</sup> 2.5 gm cm <sup>2</sup>
MAXIMUM FRICTION TORQUE (at room temperature)	0.05 oz in 3.5 gm cm	WEIGHT	4.2 oz 120 g

Shaft splined and threaded to enable gear to be fitted.

#### ELECTRICAL DATA

INPUT Rotor		OUTPUT Stator	
WINDING	Single phase	WINDING	3-phase star connected
NO LOAD CURRENT	0.03A	VOLTAGE BETWEEN TERMINALS (No Load)	90V max
NO LOAD POWER	0.7W	RESIDUAL VOLTAGE AT NULL POSITIONS	
IMPEDANCE AT 115V 400c/s	700 + j 3700 ohms	FUNDAMENTAL COMPONENT	45mV max
D. C. RESISTANCE	445 ohms	TOTAL RESIDUAL	75mV max
		IMPEDANCE BETWEEN TERMINALS AT 90V 400c/s	490 + j 2520 ohms
		D. C. RESISTANCE BETWEEN TERMINALS	300 ohms

### MUIRHEAD

F11 M-2-A/1 SIZE 11 CONTROL TRANSFORMER

U. S. Bureau of Ordnance Number 11CT 4a MARK 24 MOD. 1.

Supply to energizing synchro 115V 400c/s

Nominal Stator/Rotor Voltages 90/58V

#### MECHANICAL DATA

BEARINGS	Single row ball journal bearings	ACCURACY (MAXIMUM ELECTRICAL ERROR)	7 minutes
ROTOR CONNEXIONS	Silver strip brushes, Silver slip rings	MOMENT OF INERTIA OF ROTOR	0.014 oz in <sup>2</sup> 2.5 gm cm <sup>2</sup>
MAXIMUM FRICTION TORQUE (at room temperature)	0.05 oz in 3.5 gm cm	WEIGHT	4.2 oz 120 g

Shaft splined and threaded to enable gear to be fitted.

#### ELECTRICAL DATA

INPUT Stator		OUTPUT Rotor	
WINDING	3-phase star connected	WINDING	Single-phase
SUPPLY FROM TRANSMITTER PER PHASE	90V maximum	VOLTAGE ACROSS 20,000 OHM LOAD	1V per degree
CURRENT PER PHASE	12mA	RESIDUAL VOLTAGE AT NULL POSITIONS	initial misalignment
IMPEDANCE BETWEEN TERMINALS AT 90V 400c/s	1250 + j 7400 ohms	FUNDAMENTAL COMPONENT	30mV max
D. C. RESISTANCE BETWEEN TERMINALS	535 ohms	TOTAL RESIDUAL	60mV max
		IMPEDANCE AT 58V 400c/s	680 + j 3200 ohms
		D. C. RESISTANCE	370 ohms

Copies of the above data together with mounting instructions may be had free on request by writing to the address below.

### MUIRHEAD

MUIRHEAD INSTRUMENTS, Inc. 677 Fifth Ave., New York 22, N. Y.

United States Sales and Service for MUIRHEAD & CO., LIMITED • Beckenham • Kent • England

# Sylvania Tubes and designed for

**Full line of tubes and semiconductors is carefully designed and produced to exhibit reliability characteristics essential in good computer design.**

In the computer field, as perhaps in no other, the importance of Sylvania's integrated production of tube and semiconductors from raw material to finished product assumes important proportions.

A prime example is the development of special cathode alloys to reduce cathode interface problems. Another is the controlled processing of germanium to achieve properties which contribute to diodes and transistors with faster transient response.

These and many other factors in the design and production of tubes and semiconductors make Sylvania a supplier of major importance to computer manufacturers.



**TYPE 6888 —**

A gated pentode built to rugged computer specifications. Features sharp cut-off, controlled to close tolerances. Designed to minimize flicker shorts and interelectrode leakage for greater reliability.



**TYPE 6350 —**

A high perveance twin triode designed for heavy duty computer applications. Capable of delivering peak cathode currents of 300 ma and total dissipation up to 7 watts. Features separate cathode construction.

## OTHER COMPUTER TYPES:

7AK7 ..... sharp cut-off pentode  
5915A ..... sharp cut-off pentode  
6145 ..... sharp cut-off pentode  
6814 ..... sharp cut-off pentode

5844 ..... low mu dual triode  
5963 ..... low mu dual triode  
5965 ..... low mu dual triode  
6211 ..... low mu dual triode  
5964 ..... low mu dual triode



# SYLVANIA

SYLVANIA ELECTRIC PRODUCTS INC.  
1740 Broadway, New York 19, N. Y.  
In Canada: Sylvania Electric (Canada) Ltd.  
Shell Tower Building, Montreal

LIGHTING • RADIO • TELEVISION • ELECTRONICS • ATOMIC ENERGY



# Semiconductors computers

What every computer designer should know about Sylvania components is detailed in a new 64-page book available upon request—

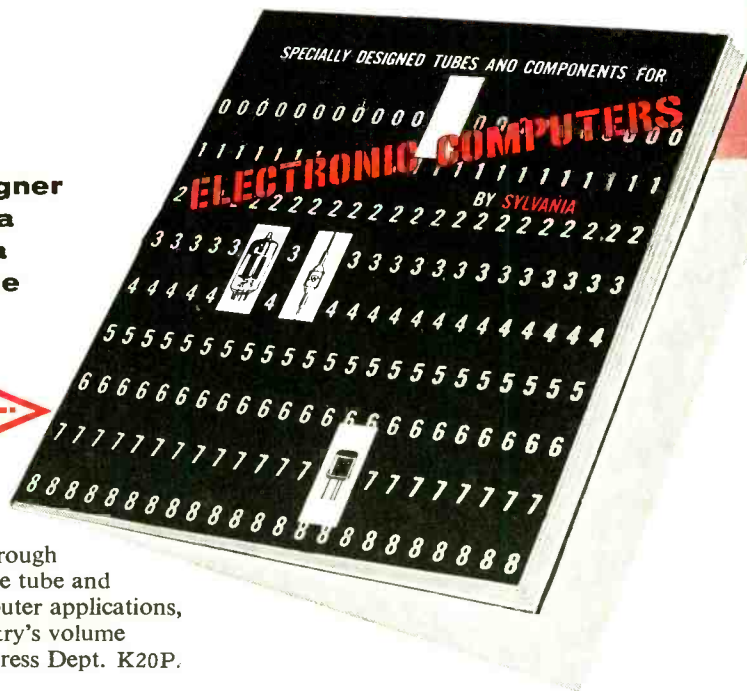

Here, in one book, is the complete story of Sylvania's service to the computer manufacturer: Sylvania's philosophy of reliability; thorough testing procedures; ability to develop the tube and transistor parameters required for computer applications, and Sylvania's ability to meet the industry's volume requirements. Write for your copy. Address Dept. K20P.

## 2N94A TRANSISTOR—

A high speed NPN switching transistor designed for reliable operation in computers. The type 2N94A combines excellent transient response with high gain at high peak current levels.

## POINT CONTACT and VLI DIODES—

Very Low Impedance Diodes offer high forward conductance with fast recovery time and stable drift-free performance. A complete line is offered to meet a range of current and voltage requirements. Point contact diodes for extremely fast transient response featuring high back resistance at elevated temperatures.

## COUNTER TUBES—

### TYPE 6802—

A multiple output, cold cathode bidirectional decade counter providing visible and electrical outputs.

### TYPE 6879—

A miniaturized version in a T5½ bulb, this tube features the advantages of the 6802 which includes reliable long-life operation.

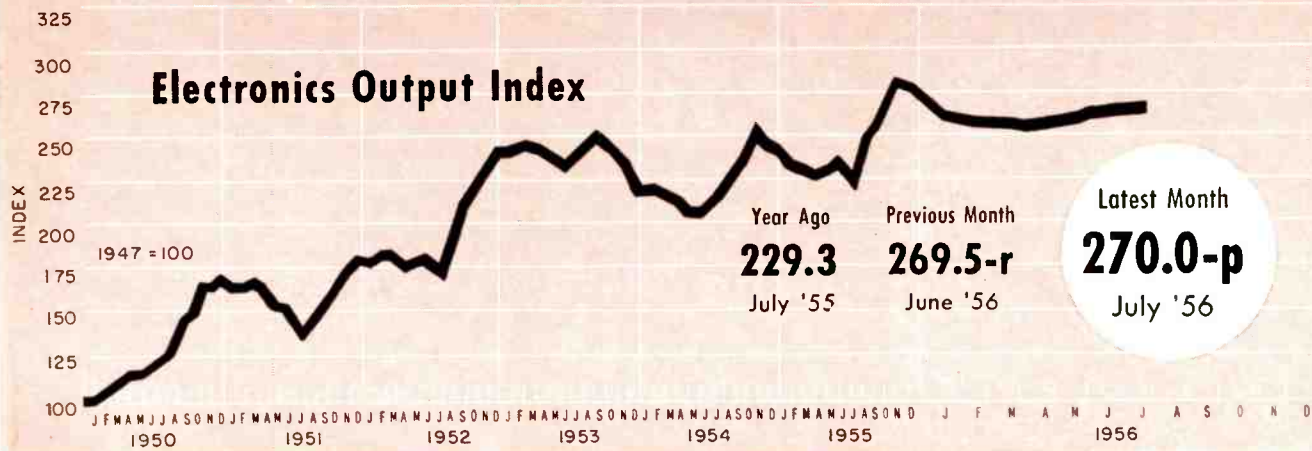

## FIGURES OF THE MONTH

	Latest Month	Previous Month	Year Ago
<b>RECEIVER PRODUCTION</b>			
(Source: RETMA)	July '56	June '56	July '55
Television sets, total	336,931	553,025	344,295
With UHF	41,803	78,512	63,466
Color sets	nr	nr	nr
Radio sets, total	566,697	1,073,775	718,489
With F-M	273	nr	2,385
Auto sets	198,565	296,256	404,443

### RECEIVER SALES

	July '56	June '56	July '55
(Source: RETMA)			
Television sets, units	405,310	439,362	381,567
Radio sets (except auto)	576,453	839,830	303,965

### RECEIVING TUBE SALES

	July '56	June '56	July '55
(Source: RETMA)			
Receiv. tubes, total units	31,400,000	39,037,000	28,340,000
Receiv. tubes, value	\$24,781,000	\$32,176,000	\$21,167,000
Picture tubes, total units	585,380	776,601	515,793
Picture tubes, value	\$10,861,634	\$13,663,408	\$9,498,169

### INDUSTRIAL TUBE SALES

	Quarterly Figures		
	Latest Quarter	Previous Quarter	Year Ago
(Source: NEMA)	1st '56	4th '55	1st '55
Vacuum	\$8,754,054	\$9,967,411	\$8,784,478
Gas or vapor	\$3,394,059	\$3,251,621	\$3,747,490
Magnetrons and velocity modulation tubes	\$15,136,522	\$13,726,323	\$14,229,442
Gaps and T/R boxes	\$1,455,558	\$1,578,767	\$1,434,683

### MILITARY PROCUREMENT

	1st '56	4th '55	1st '55
(Source: Defense Dept.)			
Army	\$40,490,000	\$48,477,000	\$2,833,000
Navy	\$28,700,000	\$20,378,000	\$43,147,000
Air Force	\$124,828,000	\$131,938,000	\$133,503,000
Total—Electronics	\$194,018,000	\$200,793,000	\$179,483,000

### BROADCAST STATIONS

	Latest Month	Previous Month	Year Ago
(Source: FCC)	Aug. '56	July '56	Aug. '55
TV stations on air	507	499	469
TV stations CPs—not on air	113	116	111
TV stations—new requests	49	42	24
A-M stations on air	2,939	2,922	2,758
A-M stations CPs—not on air	112	119	115
A-M stations—new requests	268	263	215
F-M stations on air	525	530	540
F-M stations CPs—not on air	20	19	16
F-M stations—new requests	9	7	6

### COMMUNICATION AUTHORIZATIONS

	July '56	June '56	July '55
(Source: FCC)			
Aeronautical	49,639	48,745	44,435
Marine	57,529	56,915	51,528
Police, fire, etc.	20,943	20,718	18,593
Industrial	30,776	30,597	25,189
Land transportation	9,027	8,990	7,792
Amateur	149,032	150,549	137,682
Citizens radio	19,253	18,602	12,801
Disaster	327	327	317
Experimental	722	706	639
Common carrier	2,356	2,308	1,964

### EMPLOYMENT AND PAYROLLS

	June '56	May '56	June '55
(Source: Bur. Labor Statistics)			
Prod. workers, comm. equip.	389,100-p	386,900-r	357,400
Av. wkly. earnings, comm.	\$74.59 -p	\$75.55 -r	\$71.56
Av. wkly. earnings, radio	\$72.40 -p	\$72.22 -r	\$69.43
Av. wkly. hours, comm.	40.1 -p	40.4	40.2
Av. wkly. hours, radio	40.0 -p	39.9	39.9

### SEMICONDUCTOR SALES ESTIMATES

	June '56	May '56	Apr. '56*
Transistors, Units	1,130,756	897,862	832,676

### STOCK PRICE AVERAGES

	Aug. '56	July '56	Aug. '55
(Source: Standard and Poor's)			
Radio-tv & electronics	405.8	412.6	462.1
Radio broadcasters	510.2	509.8	533.9

p—provisional r—revised nr—not reported

\*1955 not available

## FIGURES OF THE YEAR

Television set production	3,752,133
Radio set production	7,225,862
Television set sales	3,273,560
Radio set sales (except auto)	3,967,555
Receiving tube sales	259,056,000
Cathode-ray tube sales	5,738,123

## FIGURES FOR FIRST SIX MONTHS

	1956	1955	Percent Change	1955 Total
Television set production	3,752,133	4,173,088	-10.1	7,756,521
Radio set production	7,225,862	7,777,378	-7.1	14,894,695
Television set sales	3,273,560	3,584,562	-8.7	7,421,084
Radio set sales (except auto)	3,967,555	2,732,983	+45.2	6,921,384
Receiving tube sales	259,056,000	254,842,000	+1.6	479,802,000
Cathode-ray tube sales	5,738,123	5,429,817	+5.7	10,874,234

## Future Missile Components Withstand 500 C

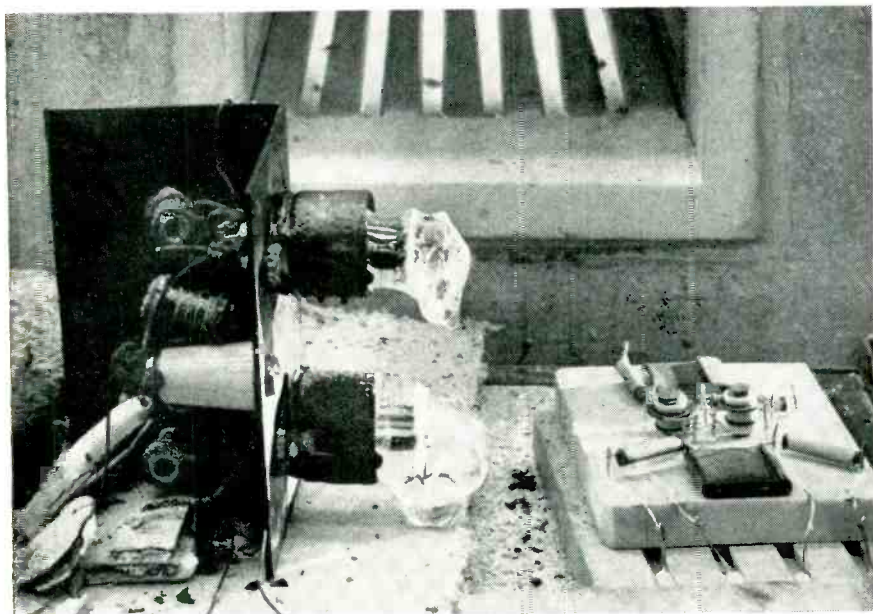

Two-tube developmental circuit at right operated thousands of hours in 800 C oven, far beyond critical aircraft temperature barrier. Comparable conventional components at left melted almost immediately

### Red-hot operating units now feasible for ICBM missiles, satellites and nuclear aircraft

DEVELOPMENT of high-temperature electronic equipment capable of operating in future high-speed aircraft has been announced by General Electric Research Laboratories. The new components and insulating materials withstand high levels of nuclear radiation as well.

Cost of the high-temperature research program has been shared by AEC, Air Force, Army and Navy. Work on some components, particularly tubes, permits operating temperatures over 800 C.

► **Heaterless Tubes**—At ambients over 600 C, ceramic-envelope tubes provide ample cathode emission without external heater power. Heaters are needed only for operation within the earth's atmosphere. These can be disconnected when the ambient gets high enough. Diode and triode versions will go into production for military use this fall.

Use of titanium for tube electrodes gives gas-absorbing action at high temperatures and minimizes grid or plate emission. Heaterless tubes have a simple six-piece design that lends itself to automatic production and has engineering advantages.

► **Transformers** — Windings of high-temperature transformers, motors and servos can be made conventionally at only slight extra care, using Inconel or silver-clad copper wire coated with a high-temperature glass. Range of diameters is 5 to 70 mils. A medium-silicon grain-oriented steel having a Curie temperature well above 500 C is used for cores. With woven glass outer insulation, sample units have operated hundreds of hours at 520 C.

► **Resistors**—Deposited-film resistors developed in the program can withstand up to 600 C. The film is inside a ceramic tube with titanium

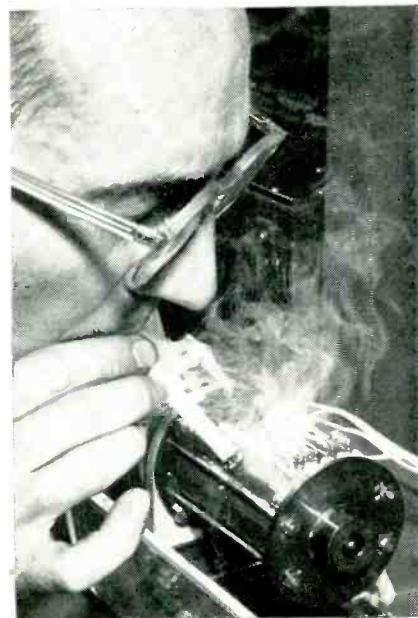

Transformers and servo motors operate at temperatures hot enough to light cigarette

end caps and sealed under vacuum.

► **Capacitors**—Special heat treatment for certain types of natural mica prevents crumbling when water molecules are driven out at around 600 C, permitting capacitors to operate up to 800 C.

► **Printed Circuits** — Forsterite ceramic base plates with platinum wires and fired silver conductors withstand up to 700 C. Circuits using this construction have operated in the flame of gas torches.

## Tape Maker Enters Video Recording

Minnesota Mining takes over Bing Crosby Enterprises' tv recording equipment

MAGNETIC tape manufacturer, Minnesota Mining and Mfg. Co. has purchased the television tape recording activities of Bing Crosby Enterprises. The firm takes over and will continue the video recorder and certain other research programs conducted by the electronics division of the Crosby organization.

The transaction involved an initial payment by 3M of \$75,000 toward an undisclosed sum for Crosby equipment and inventories including the video recording equipment. A number of Crosby patents to be transferred to 3M will be paid for from future sales.

► **Personnel** — Under the agreement, a group of Crosby research staff members will become 3M employees. The group, headed by John Mullins and Wayne Johnson, has worked for several years on Crosby video tape recording projects. Research will be done at new lab headquarters in the Los Angeles area.

► **Future**—Minnesota Mining has no immediate plans to produce a tv tape recorder but the firm has not entirely closed the door on that possibility. The main reason for the purchase, according to the company, is to improve magnetic tape for tv and to keep abreast of tv recording developments so as to have magnetic tape products available when they are needed.

## Industry High In Defense Business

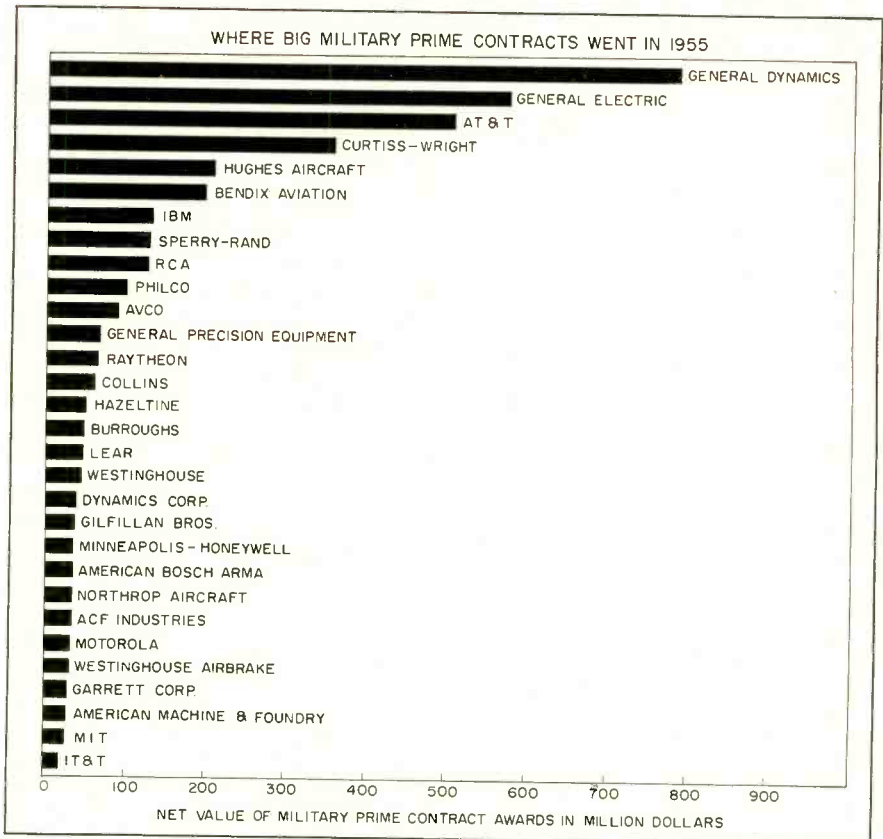

Nearly one-third of the 100 leading military contractors last year were in electronics

THIRTY companies in the electronics field garnered 25 percent of total military prime contracts awarded during 1955. The awards totaled \$3.8 billion out of a \$15.2-billion total. The firms were among the top 100 companies in awards for 1955 that accounted for 69.2 percent or \$10.5 billion of total contracts. Individually the 30 electronics companies had contracts worth from 0.1 percent to 15.5 percent of 1955 awards.

► **Normal Period** — The Defense Department identifies the 1955 period as the third phase of the U. S. military procurement program. It represents a more normal period of procurement to modernize the equipment of the armed forces, build up mobilization reserves and maintain the mobilization base.

The first phase, from July 1950 through June 1953, is described as a period of greatly expanded procurement to support combat in

Korea. The second phase, from July 1953 to December 1954, was one of extensive cancellations of contracts for combat equipment that was no longer needed after the cease fire in Korea and readjustment of the military buying program to a peacetime basis.

► **Changes**—The Defense Department's list of the top 100 companies in military contracts is constantly changing. Many of the shifts are caused by acquisitions of new subsidiaries which are also military prime contractors. A total of 304 companies, including parent and subsidiary companies, was represented on the list as of December, 1955 compared to 240 in 1953.

During the first six months of 1955, companies in electronics accounted for about 20 percent of total prime contract awards compared to 25 percent for the entire year (ELECTRONICS, p 12, June '56).

Increasing emphasis on procurement of aircraft and missiles has also changed the list. During 1955, aircraft and missile companies re-

(Continued on p 12)

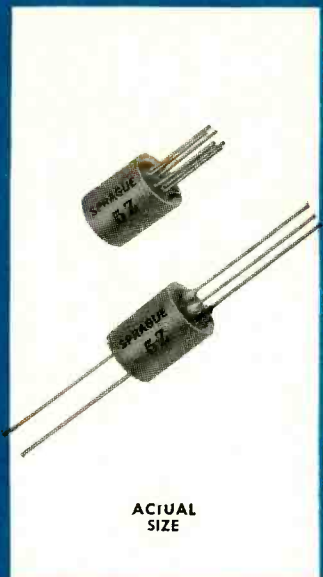

ACTUAL SIZE

# a new complete line of subminiature pulse transformers

Take maximum advantage of available space on crowded wiring boards and in cramped chassis with Sprague's truly miniaturized line of reliable pulse transformers.

Designed to meet the environmental requirements of specification MIL-T-27A, these new Sprague designs offer dependability without sacrifice in electrical performance of their larger counterparts. The hermetically-sealed tubular metal cases are available with pin terminals on

one end for mounting on printed wiring boards or with the conventional wire leads on opposite ends. The complete set of standard ratings shown below will take care of most circuit requirements.

Complete data on Sprague's new type 5Z pulse transformers are shown in Engineering Bulletin 503, available on letterhead request to the Technical Literature Section, Sprague Electric Company, 35 Marshall Street, North Adams, Mass.

## TYPICAL SPECIFICATIONS

Cat. No.*	Turns Ratio	Lp (mH)	LL (μH)	Cd (μF)	Source Impedance 100 Ω			Source Impedance 500 Ω			Source Impedance 1000 Ω		
					Load (Ohms)	Pulse Width** (μsec)	Rise Time (μsec)	Load (Ohms)	Pulse Width** (μsec)	Rise Time (μsec)	Load (Ohms)	Pulse Width** (μsec)	Rise Time (μsec)
5Z1 and 5Z2	1:1	0.5	1.0	6.0	50	1.8	0.01	250	0.40	0.01	500	0.24	0.01
					100	1.2	0.01	500	0.28	0.01	1000	0.20	0.01
					200	0.8	0.01	1000	0.22	0.01	2000	0.15	0.01
5Z3 and 5Z4	3:1	0.5	2.0	6.0	5	1.8	0.02	27	0.40	0.02	55	0.24	0.02
					11	1.2	0.02	55	0.28	0.02	110	0.20	0.02
					22	0.8	0.02	110	0.22	0.02	220	0.15	0.02
5Z5 and 5Z6	5:1	0.5	2.5	6.0	4	1.2	0.02	10	0.40	0.02	20	0.24	0.02
					8	0.8	0.02	20	0.28	0.02	40	0.20	0.02
								40	0.22	0.02	80	0.15	0.02
5Z7 and 5Z8	1:1:1	0.5	2.0	12.0	50	1.8	0.025	250	0.40	0.02	500	0.24	0.02
					100	1.2	0.025	500	0.28	0.02	1000	0.20	0.02
					200	0.8	0.025	1000	0.22	0.02	2000	0.15	0.02
5Z9 and 5Z10	1:1	1.0	1.5	6.0	50	3.4	0.015	250	0.70	0.015	500	0.38	0.015
					100	2.2	0.015	500	0.54	0.015	1000	0.28	0.015
					200	1.6	0.015	1000	0.40	0.015	2000	0.25	0.015
5Z11 and 5Z12	3:1	1.0	2.5	6.0	5	3.4	0.02	27	0.70	0.02	55	0.38	0.02
					11	2.2	0.02	55	0.54	0.02	110	0.28	0.02
					22	1.6	0.02	110	0.40	0.02	220	0.25	0.02
5Z13 and 5Z14	5:1	1.0	4.0	6.0	4	2.2	0.02	10	0.70	0.02	20	0.38	0.02
					8	1.6	0.02	20	0.54	0.02	40	0.28	0.02
								40	0.40	0.02	80	0.25	0.02
5Z15 and 5Z16	1:1:1	1.0	2.5	12.0	50	3.4	0.025	250	0.70	0.025	500	0.38	0.025
					100	2.2	0.025	500	0.54	0.025	1000	0.28	0.025
					200	1.6	0.025	1000	0.40	0.025	2000	0.25	0.025
5Z17 and 5Z18	1:1	2.5	3.0	6.0	50	8.7	0.02	250	1.9	0.02	500	0.94	0.02
					100	5.4	0.02	500	1.2	0.02	1000	0.66	0.02
					200	3.6	0.02	1000	0.8	0.02	2000	0.45	0.02
5Z19 and 5Z20	3:1	2.5	3.5	6.0	5	8.7	0.025	27	1.9	0.025	55	0.94	0.025
					11	5.4	0.025	55	1.2	0.025	110	0.66	0.025
					22	3.6	0.025	110	0.8	0.025	220	0.45	0.025
5Z21 and 5Z22	5:1	2.5	5.0	6.0	4	5.4	0.025	10	1.9	0.025	20	0.94	0.025
					8	3.6	0.025	20	1.2	0.025	40	0.66	0.025
								40	0.8	0.025	80	0.45	0.025
5Z23 and 5Z24	1:1:1	2.5	6.5	12.0	50	8.7	0.04	250	1.9	0.04	500	0.94	0.04
					100	5.4	0.04	500	1.2	0.04	1000	0.66	0.04
					200	3.6	0.04	1000	0.8	0.04	2000	0.45	0.04
5Z25 and 5Z26	1:1	6.0	6.0	6.0	50	21.0	0.03	250	4.0	0.03	500	1.8	0.03
					100	13.0	0.03	500	2.6	0.03	1000	1.4	0.03
					200	8.4	0.03	1000	1.8	0.03	2000	1.0	0.03
5Z27 and 5Z28	3:1	6.0	11.0	6.0	5	21.0	0.04	27	4.0	0.04	55	1.8	0.04
					11	13.0	0.04	55	2.6	0.04	110	1.4	0.04
					22	8.4	0.04	110	1.8	0.04	220	1.0	0.04
5Z29 and 5Z30	5:1	6.0	14.0	6.0	4	13.0	0.04	10	4.0	0.04	20	1.8	0.04
					8	8.4	0.04	20	2.6	0.04	40	1.4	0.04
								40	1.8	0.04	80	1.0	0.04
5Z31 and 5Z32	1:1:1	6.0	17.0	12.0	50	21.0	0.07	250	4.0	0.07	500	1.8	0.07
					100	13.0	0.07	500	2.6	0.07	1000	1.4	0.07
					200	8.4	0.07	1000	1.8	0.07	2000	1.0	0.07

\*First cat. no. is for 2-ended style, second is for single-ended plug-in style.  
 NOTE: Two winding transformers can be furnished with tapped windings to customer specifications.  
 \*\*For 10% Droop.

the mark of reliability

# SPRAGUE®

Export for the Americas: Sprague Electric International Ltd., North Adams, Mass. CABLE: SPREXINT

ceived 34.9 percent of total awards. In 1953, the portion was 27.1 percent. For the period from June, 1950 through the end of 1955, the companies received 30.3 percent of all prime contract awards.

► **Total**—During the same period, the net value of prime defense contracts reached \$130 billion. The

top 100 contractors accounted for \$81.5 billion or 62.7 percent of the amount.

Among the 100 were 28 firms heavily engaged in electronics. They accounted for \$23.3 billion or 17 percent of total awards. Seven of the companies had contracts totaling over \$1 billion.

cisco. Schedule calls for building 123 Ramic's in 1957 and by 1958, 900 a year.

► **Wedding**—The juke-box memory has been wedded to the model 650 magnetic-drum calculator. There are about 350 basic 650's in use today with nearly 1,000 on order.

The basic 650 has a magnetic-drum memory that will store 20,000 digits. As a first step in improving its memory, up to six magnetic-tape handling units can be connected to the computer through a 600-digit magnetic-core storage unit.

Up to four juke-box random-access memories each with a capacity of 6,000,000 digits can be connected.

► **Typewriter**—Possibly the ultimate step in electronics invasion of the business office would be a electronic typewriter. One step in that direction was recently taken by IBM. A new model of the firm's electric typewriter is equipped with a device that senses vertical lines printed in conductive ink on business forms.

When the electronic tab lever on the typewriter keyboard is depressed, the electrically conductive vertical rules program the typewriter's tabulator. The electronic unit, mounted beneath the keyboard, uses one tube, one rectifier and at least one diode.

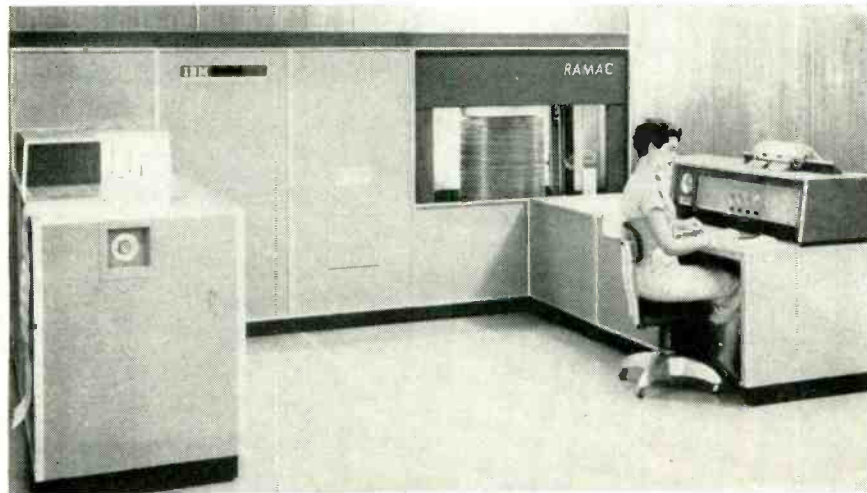

CONTINUOUS or in-line accounting may become feasible when . . .

## Computer Stores 5 Million Digits

Electronic typewriter control, new scientific computer and special-purpose units appear

PRODIGIOUS rapid-access memories make two recently introduced computers especially well suited to processing large volumes of business data without resorting to batch handling. This could provide much closer management control over business operations.

The IBM model 305 RAMAC relies upon the juke-box memory developed at the firm's San Jose, Calif. laboratory. The memory consists of 50 magnetic metal disks arranged in a vertical stack.

There are 100 recording tracks on each disk face. Each track will hold upwards of 10,000 characters.

Access is gained by an electronically controlled reading arm that moves vertically and horizontally. The entire stack rotates at 1,200 rpm.

The RAMAC computer also includes a printer, 100-card-a-minute card punch, data-processing

unit consisting of a magnetic drum and a 100-character magnetic-core storage unit and operating console.

Typical applications include billing, inventory, sales analysis, payroll, budget and production control.

Fourteen prototype Ramic units are under construction at IBM's San Jose, Calif. plant. The machine is already in use at Crown Zellerbach Paper Co. in San Fran-



Electric typewriter with electronic tabulator control

## U. S. To Double Research Reports

New service for research scientists will make results of federal projects available

THE Government plans to make available to research scientists the results of thousands of basic research projects carried out with federal money by private and academic groups. It aims to provide basic scientific researchers with the same kind of information service that has been furnished heretofore on developmental and applied research.

► **Organization** — The Office of  
(Continued on p 14)

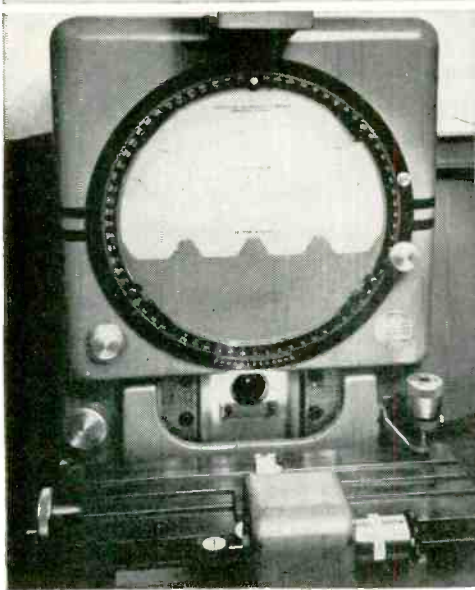
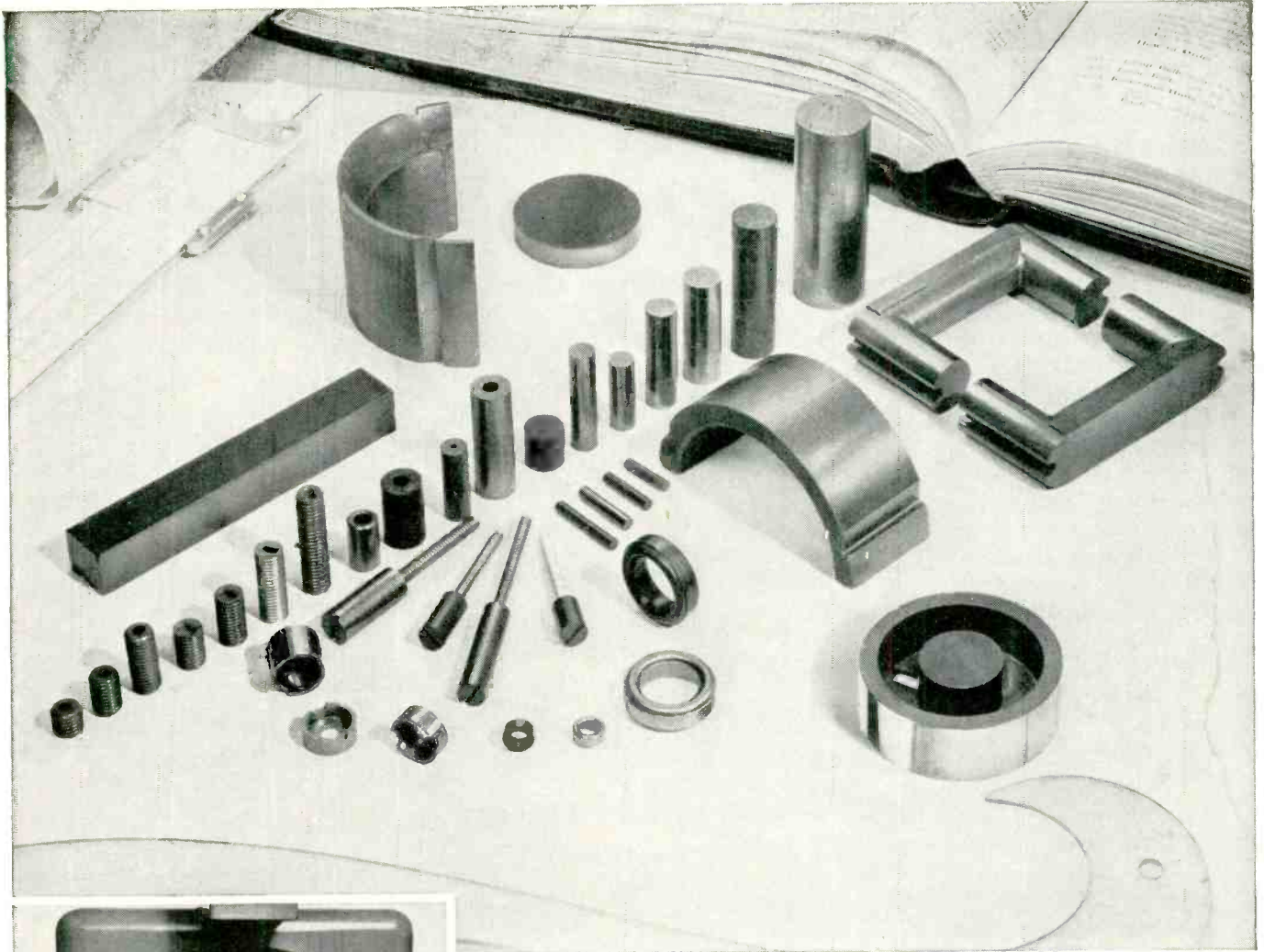

**COMPARATOR-CHECKED  
to insure precision parts**

Threaded cores are checked on an optical comparator at 100-x magnification to assure exact conformance. Arnold quality control of iron powder cores includes the maintaining of rigid electrical, physical and dimensional specifications unmatched in the industry.

**Write for a copy of Bulletin PC-109**

Contains essential data on processing, control methods, applications, types, sizes, suggested use frequencies, etc. of Arnold iron powder cores.

**ADDRESS DEPT. E-610**

# IRON POWDER CORES

to meet your highest requirements

- ★ *FOR QUALITY*
- ★ *FOR DIMENSIONAL ACCURACY*

Here are the essential facts to keep in mind about iron powder cores—and Arnold. As illustrated above, we make a wide selection of cores, from simple cylinders to special cores of complicated design. That includes all standard types and sizes of threaded cores, cup, sleeve, slug and cylindrical insert cores you may require: for use in antenna and RF coils, oscillator coils, IF coils, perm tuning, FM coils, television RF coils, noise filter coils, induction heating and bombarder coils, and other low frequency applications. Also, a standard series of iron powder toroids is being engineered at this time, which will conform to the standard sizes proposed by the Metal Powder Association. • We'll appreciate the opportunity to supply your needs . . . *let us quote on your requirements.*

WSW 6044

## THE ARNOLD ENGINEERING COMPANY

SUBSIDIARY OF ALLEGHENY LUDLUM STEEL CORPORATION

General Office & Plant: Marengo, Illinois

DISTRICT SALES OFFICES . . . New York: 350 Fifth Ave.

Los Angeles: 3450 Wilshire Blvd.

Boston: 200 Berkeley St.



Scientific Information of The National Science Foundation has set up a new unit for the program—The Government Research Information Clearinghouse headed by Dwight E. Gray.

GRIC will help research scientists to:

Learn what unclassified scientific reports on government research are being issued in his field of interest and how he can obtain them.

Obtain, on a subscription basis, a report-announcement service that automatically keeps him posted on the bulk of such reports in fundamental research.

Obtain access to a catalogued reference collection of scientific reports on federally-supported basic research, being offered by the Library of Congress with a \$10,000 NSF grant.

► **Volume** — Gray estimates that federal agencies receive upwards of 20,000 technical reports a year from organizations engaged in scientific research sponsored by the Defense Dept. and other federal agencies. Of the total, the Office of Technical Services reproduces for public sale about 6,000. The majority cover developmental work.

The new program will enable OTS to double its publication schedule to about 12,000 different reports a year, about equally divided between basic and applied research projects.

## Business Briefs

► **TV Broadcaster**, American Broadcasting-Paramount Theaters, and Western Union Telegraph Co. each purchased a 25-percent interest in Wind Tunnel Instrument Co. of Newton, Mass., the third electronics firm in which the two companies now have a financial interest. The others are Microwave Associates and Technical Operations

► **Tantalum production capacity** will go up 50 percent when a new \$6.5 million tantalum-columbium plant planned by Fansteel Metallurgical goes into production. Construction will be financed by a \$4-million bank loan and the sale of \$3 million in debentures

► **Merged firms**, Baird Associates-Atomic Instrument, plan to issue up to \$750,000 in debentures to acquire new plant facilities. The company expects sales to total \$5.8 million at the end of the first fiscal year of combined operation on May 31, 1957

► **Dictating machine manufacturer**, T. A. Edison, borrowed \$2.5 million to finance the cost of recently acquired business, for other expansion plans and for additional working capital

► **Parts maker**, Amphenol Electronics, offered 120,000 shares of \$1 par value common stock at \$18.50 per share to repay \$1 million in bank loans and increase working capital. Net sales of the firm, which has approximately 5,000 customers, were \$12.9 million in the first six months of 1956 compared to \$11.8 million during the period in 1955

► **West Coast company**, Hycon Manufacturing, sold 400,000 shares of common for \$1.6 million. Proceeds will be applied to product development, equipment purchases, expansion and working capital

## Bomber's Electronics Now Costs \$6 Million

Military-type aircraft require more tubes. Air Force boosts electronics share of budget

GROWING importance of electronics in military aircraft is highlighted in a comparison made by the Aircraft Industries Association of today's bombers and fighters with those of World War II.

► **Increases**—A medium bomber today requires 40 miles of wiring compared to 10 miles for the World War II model and contains over 1,500 electronic tubes. A World War II fighter required 515 wires

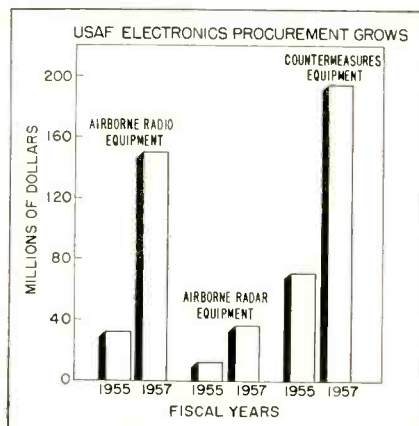

totaling 1,545 feet compared to 5,500 wires totaling nearly 23,000

feet for a jet fighter today. The modern all-weather fighter has almost \$80,000 worth of radar, rocket-firing-control and navigation equipment which was not used at all on the World War II plane. The Norden bombsight used in World War II cost \$8,000 per unit—a small fraction of the \$250,000 cost of the K-1 used in one of today's bombers. The cost of electronics alone, on three medium bombers today would buy a complete World War II bomber.

► **Complexity**—A World War II  
(Continued on page 16)



# GROWTH

## NEW KAHLE FACILITIES

Kahle paces the growth of electronics . . . anticipating your increasing needs for precision glass, wire and metal working machinery and equipment. New Plant # 2 increases present shop area over 300%.

## NEW KAHLE SERVICES

Enlarged services help solve your most difficult machinery and equipment requirements. Faster delivery will be available on all standard types. Added manufacturing facilities mean greater economy for you . . . increased laboratory and experimental facilities, too!

## NEW KAHLE DESIGNS

Kahle's growth places greater emphasis on its engineering capabilities . . . increased numbers of the most modern machine designs are now available to you . . . designs that are shaping tomorrow's electronics.

## FAMOUS KAHLE PRECISION

Kahle's exacting precision and meticulous workmanship are progressing, too . . . the cornerstone of a 25-year old reputation, as the world's largest manufacturer of specialized machinery and equipment for the electronic, glass and related industries. Need production equipment? "Call-on-Kahle."

Tell us about your specific requirements and problems.



*"The Lofty Oak From a Small Acorn." — Lewis Dinscombe*

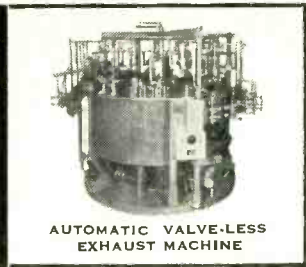
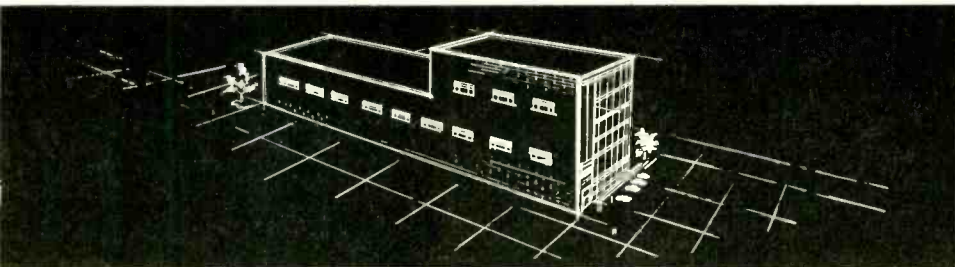

**AUTOMATIC VALVE-LESS EXHAUST MACHINE**

# KÄHLE

## ENGINEERING COMPANY

GENERAL OFFICES:  
1310 SEVENTH STREET, NORTH BERGEN, N. J.

PLANTS:  
SEVENTH STREET, NORTH BERGEN, N. J.  
HUDSON AVE., UNION CITY, N. J.

DESIGNERS AND BUILDERS OF SPECIAL AUTOMATIC AND SEMI-AUTOMATIC EQUIPMENT FOR ALL INDUSTRIAL OPERATIONS

bomber had eight electronic systems, a basic weight of 37,672 pounds and a flyaway cost of \$220,249. A modern bomber had 14 electronic systems, a basic weight of 167,685 pounds and a flyaway cost of \$6,429,259.

A World War II fighter had three electronic systems, a basic weight of 7,198 pounds and a flyaway cost of \$53,635. A modern fighter has nine electronic systems, a basic weight of 10,536 pounds and a flyaway cost of \$384,225.

► **Budget** — More electronics is being used by the Air Force as an integral part of aircraft coming off the production line. In fiscal 1957, \$1.4 billion out of \$8.4 billion, or 17.3 percent of the USAF aircraft procurement budget, is allocated for electronics. In 1952 approximately \$883.3 million out of \$9.2 billion was for electronics.

More electronics is also being used by the Air Force for modernizing in-service aircraft. Nearly \$800 million has been allocated.

The requirements for the airborne radar equipment, for example, have increased from \$11.4 million in fiscal 1955 to \$35.6 million in fiscal 1957. Electronics countermeasure equipment requirements call for \$195.5 million in fiscal 1957.

## TellerVision Takes Curbside Deposits



Closed-circuit television and an underground pneumatic tube enable a teller in a Bridgeport, Conn. savings bank to transact business with motorists more than 100 feet away. Developed by Mosler Safe Co., the system allows banks to add to service without opening a branch

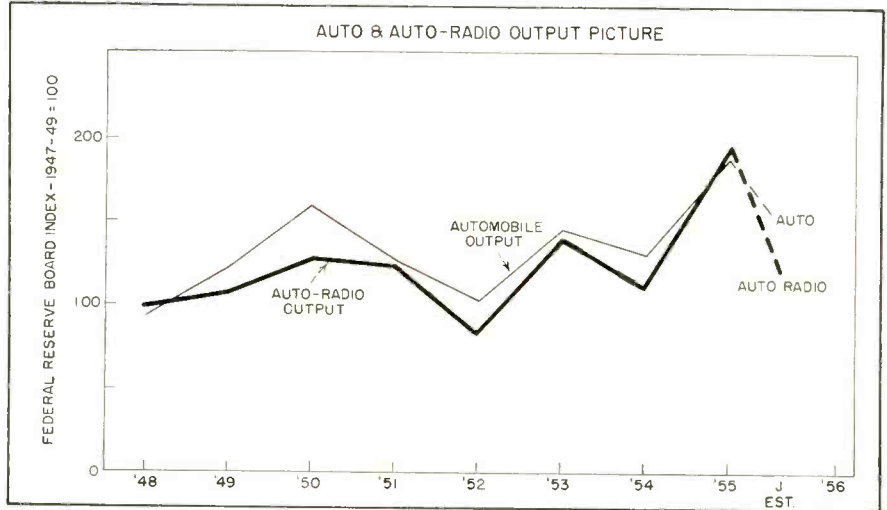

## More Auto Radios Use Transistors

**Major auto makers increase transistorized set installations. Fuel system uses transistors**

NEARLY one-third of all car radios produced this year incorporate transistors and the portion may rise next year to over 60 percent, according to estimates by leading car radio and transistor producers. Estimates range from 27 percent to 35 percent of this year's car set output.

Bendix estimates that about 35 percent of its current car radio output is transistorized. Motorola has announced that it has shipped several thousand car radio sets equipped with its power transistors.

Most of the transistorized car radio sets now being produced are hybrid sets using one power transistor.

► **Output** — Although transistorized car radios have increased in volume this year, total car radio business has declined. Through the first six months, 2,313,651 sets were produced, compared to 2,602,691 in the first half of 1955 for a drop of over 11 percent.

Car radio manufacturers expect that total output for 1956 will be 15 percent below that produced in 1955. For 1957 they see the business coming back to the 1955 level.

The close tie between auto radio production and automobile output is indicated in the chart.

Auto output for the first eight months of 1956 totaled 4.0 million,

a decline of nearly 27 percent from the 5.5 million for the same period in 1955. Most auto manufacturers will introduce 1957 models in October.

Bendix Aviation has developed an electronic fuel injector system for automobiles that use transistors. It eliminates the carburetor and air cleaner and is designed to determine engine fuel requirements and to provide each cylinder with a precisely synchronized supply of fuel.

► **Future application** — With emphasis increasing on safety devices for auto driving, a new development by Army's Engineer Research



Power transistors for auto radios go in vacuum bake oven at new Sylvania plant in New Hampshire

(Continued on page 18)



# Vacuum-Tube Voltmeter

for Long Term Accuracy  
and High Stability . . .

**Convenient for Routine Work  
Ready for that Difficult Measurement**

The G-R Type 1800-B Vacuum-Tube Voltmeter is a superb measuring instrument . . . the finest diode-type VTVM available.

This instrument provides accuracy of  $\pm 2\%$  on all a-c and d-c ranges. It incorporates unique design features that make possible measurements which are exceedingly difficult with less precise, less adaptable equipment.

Most important, when you specify this precision instrument, your VTVM will have the extra features and refinements designed to maintain the initial high accuracy throughout the long life of the instrument. Such provisions are essential to first-class operation. They are to be found in *all* General Radio instruments.



The Type 1800-B retains all of the "A" model's outstanding features. In addition, a panel switch and circuit modifications have been included to permit convenient, direct measurement of either positive or negative d-c voltages without need of reversing test leads. . . . \$415.

## What it takes to Make a Precision Voltmeter . . .

Features specifically engineered into the G-R Type 1800-B to make it the most convenient and useful Vacuum-Tube Voltmeter on the market:

- ✓ Excellent high-frequency response — measurements to at least 500 Mc without need of special grounding devices, probe disassembly, or external capacitors.
- ✓ Measurements to 1500v — 0.1 to 150 volts, a-c in six ranges and 0.01 to 150 volts, dc — 0.5v range for accurate low-voltage readings — accessory multipliers attach to probe, extending a-c and d-c ranges to 1500 volts.
- ✓ Successively higher ranges are obtained by adding amplifier degeneration, making the calibration essentially independent of tube transconductance changes — the conventional voltage divider feeding a constant-gain amplifier cannot provide this degree of reliability.
- ✓ No "wandering" zero — thorough, two-stage power supply regulation provides complete independence from line voltage fluctuations — upon zeroing on 0.5v range, no further resetting required for any range.
- ✓ Separate "balancing" diode insures stability on a-c ranges, a feature not found in many voltmeters.

Long-time-stable, wire-wound resistors eliminate component drift as a source of instability.

- ✓ High 25-megohm input impedance — open grid connection for dc provides input impedances in kilo-megohm range.
- ✓ Thoroughly shielded amplifier circuit and well filtered probe eliminate any possibility of large errors at 60 cps.
- ✓ Panel and chassis may be grounded without grounding a-c, d-c, or probe terminals, permitting voltage measurements between two points, both above d-c ground — also an important safety feature.
- ✓ Completely shielded probe affords excellent accuracy even in strong r-f fields.
- ✓ Probe cap bolts to ground plane of test circuit, effectively minimizing error from ground loop inductance or pickup.
- ✓ Type 874 coaxial fitting and 50-ohm termination are provided for convenient use of probe on coaxial lines.
- ✓ Probe conveniently plugs into standard 3/4-inch binding posts for prolonged work—additional a-c terminals on panel accept test leads.
- ✓ Illuminated meter scale, knife-edge pointer, and mirror insure ease and precision of reading under all conditions.

## GENERAL RADIO Company

275 Massachusetts Avenue, Cambridge 39, Mass., U.S.A.



Broad Avenue at Linden, Ridgely, N. J. NEW YORK AREA 920 S. Michigan Ave. CHICAGO 5  
1150 York Road, Abington, Pa. PHILADELPHIA  
8055 13th St., Silver Spring, Md. WASHINGTON, D. C. 1000 N. Seward St. LOS ANGELES 38

**WE SELL DIRECT**  
Prices are net, FOB Cambridge  
or West Concord, Mass.

and Development Lab may find application in cars. A system consisting of two-parallel wires and a vehicular-mounted receiver has been tested on the Greenland ice cap.

An alternating current is fed to wires buried in the snow on either side of the trail. The receiver detects the current and indicators in the vehicle give the driver his position on the trail.

Warning devices alarm the driver when the vehicle gets out of bounds.



Army weasel equipped with General Mills-designed loop antenna system is used to test new trail marking system on the ice cap of Greenland

## CAA To Buy More Long-Range Radar Equipment

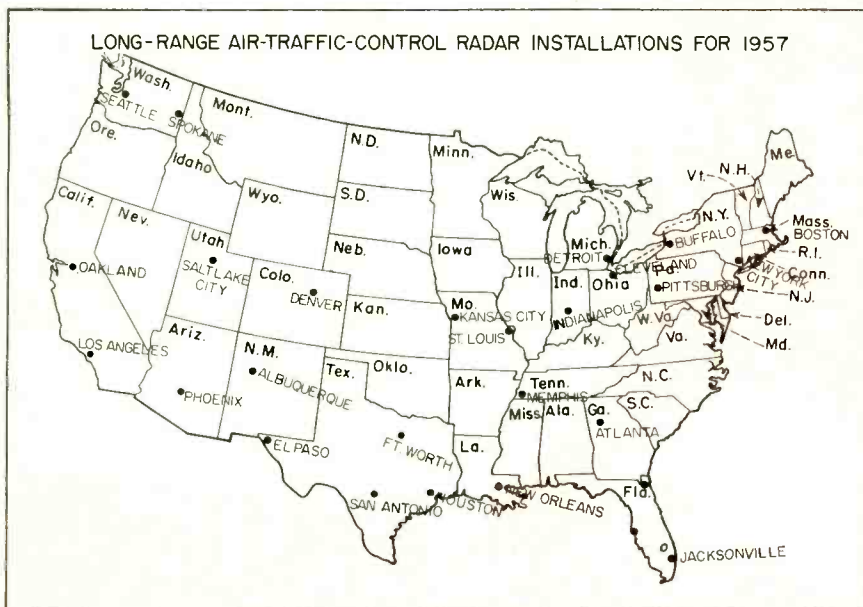

**Radar and other air traffic aids are scheduled for installation in 1957**

CIVIL Aeronautics Administration is moving ahead faster on plans to increase the nation's air navigation and traffic control facilities. It hopes to complete its five-year federal airways plan in three years. Within 18 months it expects to control flights of all civil aircraft operating on instruments at more than 15,000 feet.

The Administration has split its Office of Federal Airways into one office for air traffic control and one for air navigation facilities. The change is expected to help speed CAA's \$246-million program authorized by Congress to improve and expand air traffic control and navigation aids.

► **Radar**—First step is an increase in long-range radar equipment. The original plan scheduled \$12.4 million for 18 long-range radars to be installed during fiscal 1957 which ends next June 30.

CAA has now announced that long-range radars will be established at 26 locations, shown on the map, during the year. Investment for this equipment could run to \$18 million this year.

The New York air route traffic control center which already has a long-range radar in operation will get additional information from a long-range Navy radar at Atlantic City, N. J. The Washington, D. C. air route traffic control center has a long-range radar in operation. Another is to be commissioned in Norfolk, Va. in September and another in Chicago in November.

► **Other Facilities**—CAA has also increased its VOR program for fiscal 1957. It originally scheduled \$6.3 million for 76 installations. Under the stepped-up program, 82 VOR installations are to be made. Equipment cost could run to \$6.8 million.

During 1957 CAA also plans to install airport traffic control at 17 locations; airport surveillance radar at Miami, Fla. and Colorado Springs, Colo.; and additional frequencies at 34 airports for air-ground communications in traffic control. In addition, one new air route traffic control center will be established at Phoenix, Ariz. and equipment for automatic weather broadcasting will be installed at 16 locations throughout the U. S.

## Color TV Sales Head Toward \$75 Million

**Manufacturers revise sales estimates. More studios and stations to open in '57**

As the important last quarter of the year starts, television set makers are reappraising the potential of color tv in the light of present business conditions.

► **Estimates** — Sylvania Electric now estimates that about 150,000 color sets will be sold to the public in 1956. There are some 80,000 tv dealers in the U. S. so that small stocks with large dealers could make color set production figures

(Continued on p 20)



# PNP SILICON TRANSISTORS

made with the *FUSION ALLOY* process

## have **MAXIMUM RELIABILITY**

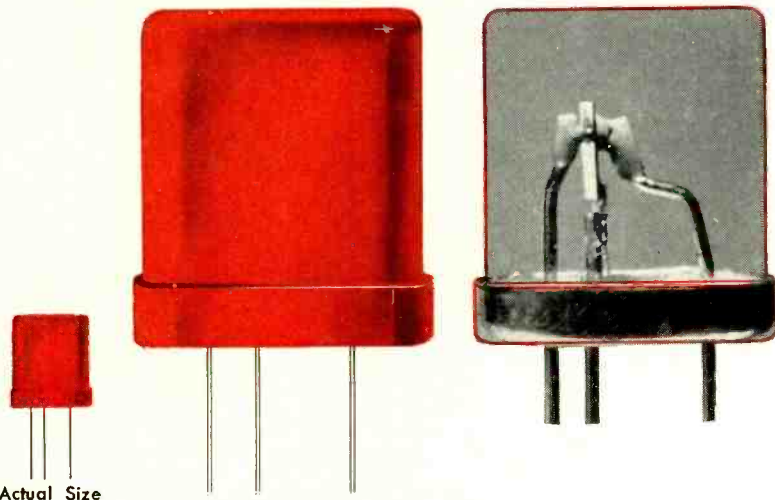

The reliability of transistors depends upon both electrical and mechanical properties.

Transistor technology has now solved most electrical problems encountered during life. As a result, greater emphasis must now be placed on the mechanical factors.

Mechanical reliability has always been inherent in the Raytheon *Fusion Alloy* process. Life tests

starting early in 1953 and aggregating over 20,000,000 transistor hours show *less than one "open" per 800,000 hours, and no shorts.*

Raytheon PNP Silicon Transistors, made by the *Fusion Alloy* process, have all this proved reliability in service, plus extraordinarily low cutoff current, low noise factor and the other desirable characteristics shown in the chart.

### RAYTHEON SILICON TRANSISTOR TESTS INCLUDE:

- *Life* — conducted at 135°C and 50 mW dissipation
- *Temperature Cycling* — 116°C (Steam at 10 lbs. gauge) and minus 60°C
- *Temperature Aging* — 100 hours at 160°C
- *Acceleration* — 5000 G centrifuge
- *Shock* — 500 G

### RAYTHEON NEW HIGH TEMPERATURE SILICON TRANSISTORS

Type	Reverse Current at Collector $\mu\text{A}$ (max.)	Emitter at -20v $\mu\text{A}$ (max.)	Beta	Base Resistance ohms	Collector Resistance kilohms	Noise Factor db (max.)	Collector Capacity $\mu\mu\text{f}$	Alpha Freq Cutoff KC
<b>CK790</b>	0.2	0.2	14	1200	500	30	30	400
<b>CK791</b>	0.2	0.2	24	1400	500	30	30	600
<b>CK793</b>	0.2	0.2	16	1300	500	15	30	500

MAXIMUM JUNCTION TEMPERATURE 150°C.

Temperature Rise (free air) 0.50°C/mW

For superior electrical performance —  
 For superior reliability in service —  
 For superior ability to meet your quantity and delivery needs —

specify **RAYTHEON PNP Fusion Alloy TRANSISTORS**  
**More In Use Than Any Other Construction Or Make**



## SEMICONDUCTOR DIVISION

Silicon and Germanium Diodes and Transistors • Silicon Power Diodes

NEWTON, MASS.: 150 California St. • DEcatur 2-7177  
 NEW YORK: 589 Fifth Ave. • PLaza 9-3900  
 CHICAGO: 9501 Grand Ave., Franklin Park • TUxedo 9-5400  
 LOS ANGELES: 622 S. La Brea Ave. • WEbster 8-2851

50,000 units higher than retail sales.

The company estimates that there are about 110,000 sets now in use with 40,000 to 60,000 to be sold in the remaining months. For 1957, Sylvania estimates that about 250,000 color sets will be sold.

RCA estimates that some 270,000 color sets will come into use this year to bring total color sets in use to 300,000. By the beginning of 1958 it expects that color sets in use will reach 1 million going to 3 million by the beginning of 1959, 7.2 million by 1960 and 12.5 million by the beginning of 1961.

As of July 1, RCA reports 60,000 sets in use, and expects that by Oct. 1 the total will reach 100,000. The company estimates that during the last quarter of this year some 200,000 color sets will come into use.

► **Tubes**—Sign that color tube business is beginning to move is evidenced in Superior Tube Company's establishment of a new department for the manufacture of color tube aperture masks. Production, which began in September, is under license of Buckbee Mears Co. of St. Paul, Minnesota.

Last year, Buckbee Mears laid plans for the establishment of additional aperture mask manufacturing facilities in New York but the lag in color tv delayed the move.

► **Programs**—NBC plans at least one major color program every night of the week in addition to spectaculars. On some nights as much as 3 hours of color tv will be available. For the fourth quarter night-time color programs will total between 120 to 130 hours per month compared with 22.5 hours in the last three months of 1955.

NBC is building a color tv station in Washington, D. C. Completion is scheduled for the fall of 1957 with the cost of the plant to be approximately \$4 million. Three new color studios, two in New York and one in Hollywood, go into operation this Fall. The studios represent the bulk of a \$12-million expenditure made within the past year to double color production facilities.

► **Color Film**—The expansion program also includes the installation of a recording system using lenticular film, a development carried out jointly by NBC, RCA and the Eastman Kodak. The system will go into operation soon. The film system will permit the network to delay color programs for the west coast so that they can be seen at the

most convenient hours.

Using the lenticular system, electronic color information is registered in black-and-white film through minute lenses which form a portion of the film itself. The film can be processed rapidly with normal black and white techniques and then played back as a color tv program.



**TELEPRINTER** designed by Creed is actuated by fsk receiver developed at Federal Telecommunication Labs. Atlantic forecast signals are picked up by recessed loop antenna to help . . .

## Airliners Avoid Bad Weather

Experiments by trans-Atlantic planes will cut interference and free voice channels

TRANSMITTERS at Chatham, New Brunswick and Galdenoch, Scotland have recently begun keying out teleprinter signals for use of eight airlines flying the Atlantic. Weather reports can be received aboard aircraft in flight and recorded automatically.

This system frees personnel from listening watches and likewise frees communications channels for instant message service. Under present practice, weather bulletins constitute about 80 percent of airways communications traffic.

► **NARCAST**—Portmanteau word to identify the new service is made up of the significant letters of North Atlantic Radioteleprinter Broadcast. Frequencies now in experimental use are 119 and 122 kc.

They are expected to eliminate interference and fadeouts resulting on higher frequencies from ionospheric disturbances.

Loop antennas of a type that will not interfere with the aerodynamic characteristics of the aircraft are used to pick up the signals that are translated into copy at the rate of 60 to 100 words a minute.

## Broadcast Employees Get Top Pay

Average annual earnings of radio and tv broadcasting workers second highest in U.S.

NATIONAL income and product statistics for 1955 compiled annually by the Department of Commerce show that full-time employees of radio and tv broadcasting organizations received average

(continued on p 22)

## How to Design for Isolation during Sustained Acceleration

It is becoming increasingly important that vibration isolators continue to provide isolation during sustained acceleration. *This is a requirement in some classes of guided missiles* If the force-deflection characteristic of the isolator is linear, it is easy to calculate the required deflection by multiplying the static deflection of the isolator under the deadweight load by the sustained acceleration expressed as a dimensionless multiple of the gravitational acceleration. Unless it has clearances at least equal to this calculated deflection, the isolator bottoms during the sustained acceleration, and provides no vibration isolation. One way to alleviate this effect is to use an isolator having non-linear force-deflection

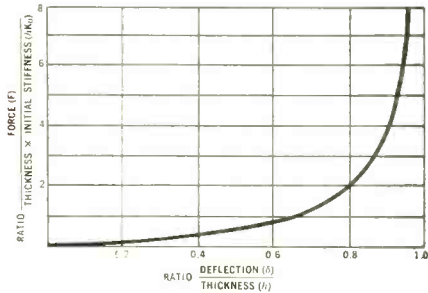

characteristics, as shown by this dimensionless curve and defined by the equation

$$\frac{\delta}{h} = \frac{2}{\pi} \tan^{-1} \left[ 15.37 \left( \frac{\ddot{x}_s}{f_0^2 h} \right) \right]$$

where  $\delta$  is the deflection of the isolator under the sustained acceleration  $\ddot{x}_s$ , is the natural frequency under normal deadweight load, and  $h$  is the "effective thickness" of the load-carrying spring. When sustained acceleration increases the static force on the isolator, deflection increases, but less than if the stiffness of the isolator were linear. This increase in deflection is accompanied by an increase in stiffness; i.e., by an increase in the slope of the force-deflection curve. The effective natural frequency is thus increased because there is no increase in mass, and the transmissibility increases.

To simplify the evaluation of changes in transmissibility, we have prepared a nomograph and set of curves for graphic solution of this problem. Write for your free copy of these useful design data — Bulletin #THO-5 — to BARRY CONTROLS Incorporated, 707 Pleasant St., Watertown 72, Mass.

From "Natural Frequency of a Nonlinear System Subjected to a Nonmassive Load", *Transactions ASME*, January, 1954

# PROVED... protection under high-g SUSTAINED ACCELERATION of the new **F-10** **CLASSIFIED\***

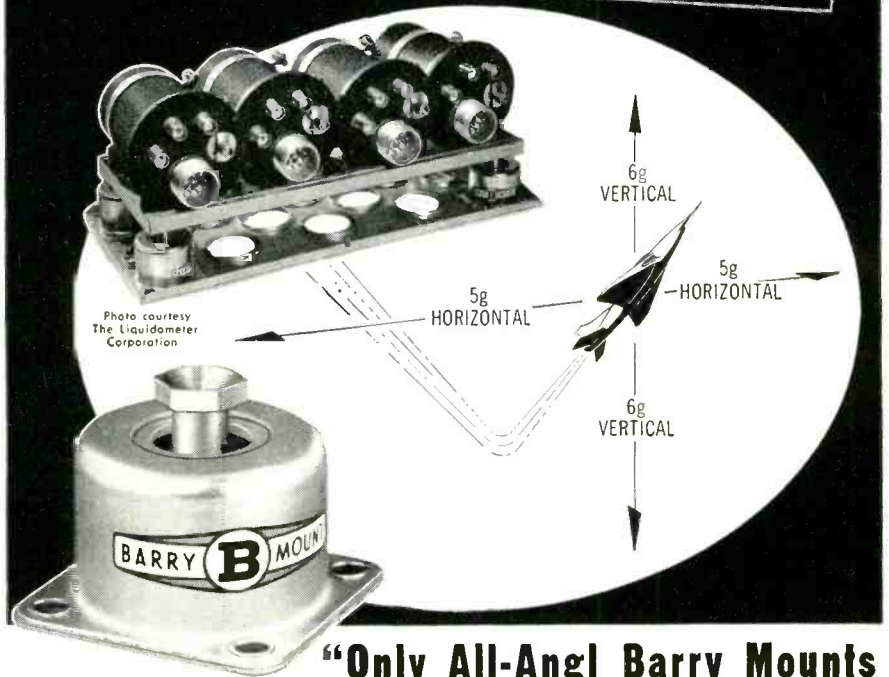

**"Only All-Angl Barry Mounts  
gave effective isolation..."**

\* One of the newest and hottest fighter aircraft now flying gives its electronic equipment such a terrific slam, when afterburners are turned on or off, that sustained accelerations bottom out MIL-spec mounts — making vibration protection *nil*.

But in this same aircraft, All-Angl Barry Mounts protect the power units of Liquidometer's four fuel-gaging systems, maintaining vibration isolation under sustained accelerations up to 6g vertical and 5g horizontal.

The pilot's life — and the success of his mission — literally depend on the trueness of his fuel-gage readings! And these readings depend on the *protected reliability* of the vacuum tubes and circuitry in the power units.

- In any mounting position
  - Through every attitude of aircraft or missile
  - Under sustained high-g acceleration . . .
- . . . All-Angl Barry Mounts give assured protection of reliability. Write for Data Sheet 956-01 giving details. For specific recommendations, call your Barry Sales Representative.

Barry's new Western Division, in Burbank, California, offers fast, on-the-spot design and prototype service, and production of special systems.

**BARRY  
CONTROLS**  
INCORPORATED

**BARRY B MOUNT**

SALES REPRESENTATIVES  
IN ALL PRINCIPAL CITIES

707 PLEASANT STREET, WATERTOWN 72, MASSACHUSETTS

earnings of \$6,333 in 1955. Their pay was exceeded by only one other classification in entire American industry, employees of security and commodity brokers, dealers and exchanges, who received average earnings of \$8,078 in 1955.

The average wage figure is obtained by dividing the industry's total payroll by the total number of full-time employees. Thus, the salaries of the highest paid directors, executives and full-time performers, are included with those of clerical employees.

► **Technical**—The government survey does not break down wage information to indicate the average pay of broadcast engineers. But the NARTB, which makes studies of wages and hours in broadcasting by job classification, estimates that engineering salaries in broadcasting run as follows:

► **Television**—The typical range of gross weekly wages for television technicians in September, 1955 in markets of up to 100,000 population was \$75 to \$94. In markets from 100,000 to 1-million population, weekly gross salaries ranged between \$78 to \$121. For markets having over 1 million people, tv broadcast technician salaries ranged from \$123 to \$151 a week or from \$6,396 to \$7,852 annually.

► **Radio**—For radio broadcasting technicians, NARTB estimates that in cities of less than 10,000 population, the average weekly wage is about \$65. In the largest city classification, 2.5 million and over, the average weekly wage runs to about \$115. The radio salaries are strictly average figures, NARTB points out, so that in both cases there are many men earning considerably more or less.

► **Trend**—In 1952 average annual broadcasting wages were \$5,559; 1953, \$5,889; 1954, \$6,029 and last year, \$6,333.

The high average annual wage of broadcasting employees in 1955 compares with an average annual wage for total U. S. industry of \$3,830 and with wages in the electrical machinery field of \$4,474.

## Military Electronics

► **Three electronics firms** received Air Force contracts worth more than \$15 million in September. Hughes Aircraft received a \$7.3 million contract for modification and overhaul of fire control systems; Western Elecrtic got a \$4.1 million supplemental contract for antennas and receiver transmitters; Motorola was awarded a \$3.7 million contract for radar set components

► **Air Research and Development Command** plans to construct a \$2.3 million, 40,000 sq ft facility for testing components of future radar systems at ARDC Air Development Center in Rome, N. Y. next spring. It will be available to Air Force engineers and industrial contractors

► **Traveling-wave tube** for military aircraft that weighs much less than present equipment is announced by Sylvania. The tube uses a system of permanent magnets instead of electromagnets for focusing. Weight is reduced from 13 pounds to 2½ pounds

► **Navy contract** of approximately \$1 million for pilot production of a number of airborne early warning search radars that operate at higher average power than previous types has been received by GE

► **Flight simulator maintenance contracts** from the Air Force went to Union Switch and Signal and ACF Industries for \$1.3 million and \$1.1 million respectively.

► **Talking beacons**, to be produced by Air Associates for the Signal Corps, utilize a plane's vhf receiver, keep aircraft on course by broadcasting bearing intelligence in a recorded voice at specified intervals

## Transistor Superhet Fits Pocket



Japanese pocket radio manufactured by Tokyo Tsushin Kogyo uses five transistors, one diode and a 2¼-inch dynamic loudspeaker, operates from a 22.5-volt battery. The set has a sensitivity of approximately 1 mv/m and weighs 290 grams

(Continued on page 24)





*a new ceramic capacitor*

*designed specifically*

*for printed wiring*

*application*

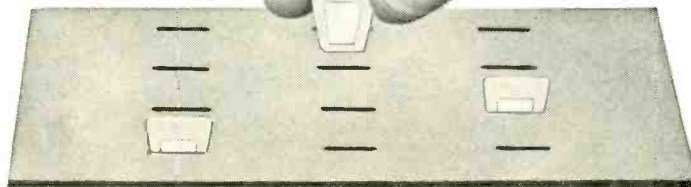
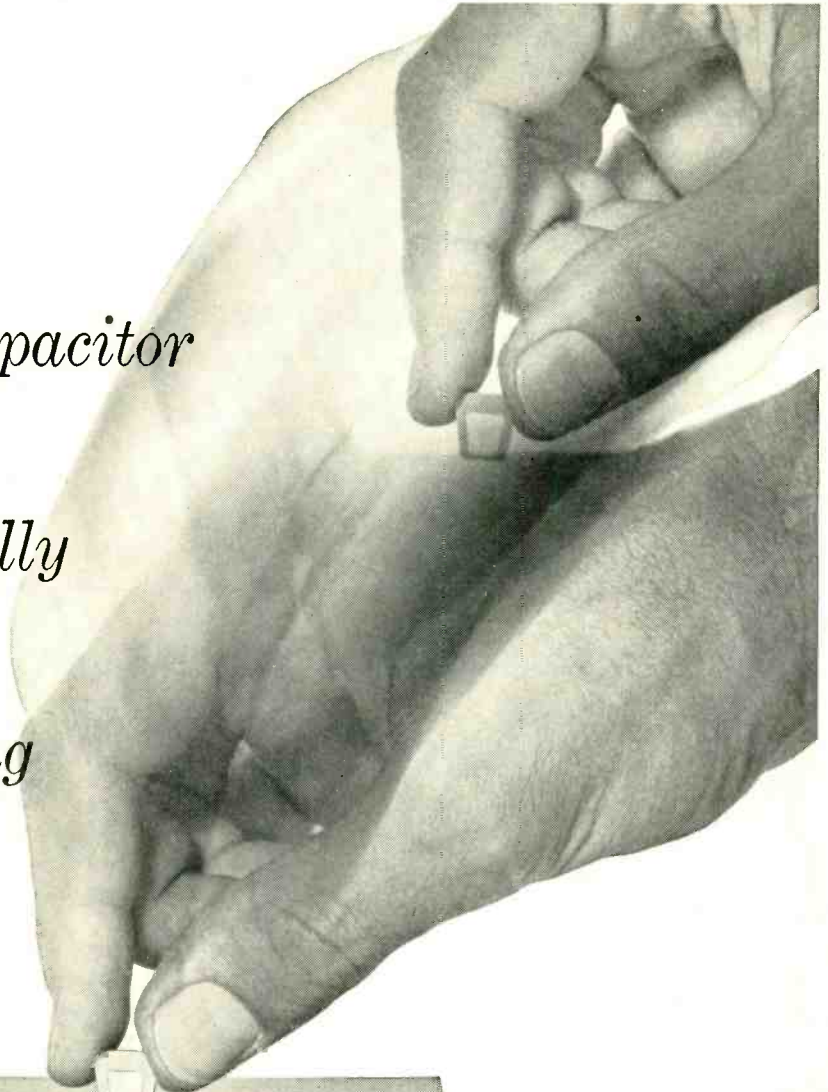

# WEJCAPS

These rugged, high performance miniature units will meet your requirements in most coupling, by-pass and other general applications. Bulky lead terminals and outside covering are completely eliminated. The dense, non-porous dielectric material withstands the most severe humidity conditions.

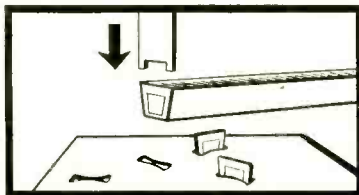

● Design problems for automatic placement heads are greatly simplified by the tapered edges and flat sides of the units.

● Strong mechanical mount is achieved by the solder connection of the silver electrode to the copper circuit.

● "Wejcap" Capacitors represent the lowest possible unit cost for comparable quality in capacitor components and offer perfect adaptability to low-cost high volume production methods.

● Developed by the producers of famous General Electric "Thru-Con" Print Wire Boards these units are the result of extensive development effort in ceramic dielectric material by General Electric scientists.

for full information write to

**GENERAL  ELECTRIC**

SPECIALTY ELECTRONIC COMPONENTS DEPARTMENT  
W. GENESEE STREET, AUBURN, NEW YORK

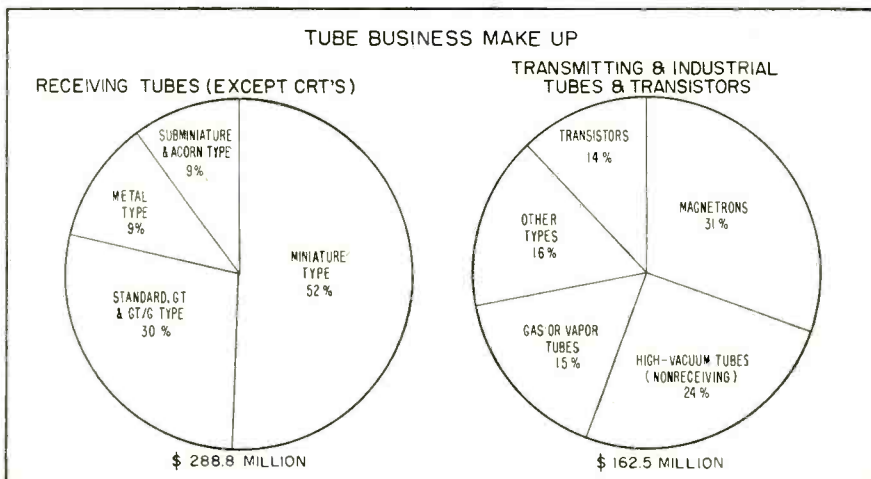

## Tube Business Hits \$800 Million

Volume keeps rising as tube types change and more firms enter the field

TOTAL factory shipments of electron tubes of all types have increased six-fold since 1947. This includes picture tubes, receiving tubes, transistors, transmitting and industrial type tubes. Factory sales increased from \$122 million in 1947 to about \$800 million in 1955.

► **Types**—Receiving tubes excluding picture tubes account for the largest volume of sales for tube makers. They represent approximately 42 percent of total tube business. Cathode-ray tubes follow with 32 percent and transmitting and industrial types account for the remaining 26 percent.

In 1947 receiving tubes accounted for 71 percent of total volume, crt's 6 percent and industrial and transmitting tubes, 23 percent.

► **Growth** — Cathode-ray tubes have shown the greatest growth of all electron tubes since 1947 due to the growth of tv. Receiving tube volume has also grown fast.

Industrial-type tube sales have risen as a result of increasing use of radar which has boosted magnetron sales from less than \$4 million in 1947 to more than \$49 million in 1954.

► **Shift**—Breakdown of receiving tube sales by types shows that miniature tubes now account for approximately 52 percent of receive-

ing tube dollar volume. They have registered a nine-fold increase in sales since 1947.

Standard types account for 30 percent followed by subminiature and acorn types with 9 percent and metal types with 9 percent. In 1947 the portion of total receiving tube dollar volume that each type accounted for was: standard, 57 percent; miniature and acorn, 19 percent; subminiature, 3 percent; metal types, 20 percent.

The percentages show the rise of miniature and subminiature tubes and the decline in importance of standard and metal types in the past 8 years.

► **Companies** — Average employment in the tube industry has increased 156 percent since 1947 to 70,900 employees. Today there are 156 tube manufacturers in the U. S. compared to 51 in 1947.

About 80 of these manufacturers employing over 33,000 workers are located in the Middle Atlantic states with Pennsylvania accounting for 19 tube manufacturers and over 15,000 employees. North Central states have 25 tube makers with close to 12,000 workers. Illinois has over 2,300 tube employees.

New England has 22 tube manufacturers but employs the second largest number of workers, nearly 15,000. The West has 20 tube makers and employs approximately 2,400 workers. The South has 7 tube firms employing nearly 8,000 workers.

## Canadian Electronics Nears Half Billion

Major show and convention for the industry takes place this month in Toronto

SHOWCASE of Canada's growing electronics industry will be the Canadian IRE Convention; to be held Oct. 1-3 in Toronto's Exhibition Park.

The convention will report on an industry which has enjoyed a seven-fold growth since 1946. Annual volume is now \$500 million. More than 120 exhibitors including government departments will participate. Engineers will deliver some 130 technical papers.

► **Radio-TV**—The Dominion has become one of the world's major tv markets since World War II. It now has over 2 million tv sets in use and ranks only behind the U. S. and Great Britain in set population. As for tv stations, only the U. S. has more than Canada's 33.

In 1955, 865,936 tv receivers were produced compared to 593,856 in 1954 for a 45.8-percent increase, according to RETMA of Canada. Sales in 1955 totaled 776,536 compared to 619,428 in 1954.

Radio production also increased in 1955. A total of 481,328 sets were made in 1955 compared to 406,078 in 1954 for an 18.5-percent increase. Radio sales last year totaled 523,066 compared to 431,456 in 1954 for a 21.2-percent increase.

► **Defense**—Growth of Canada's defense electronics business is indicated by the dollar volume of contracts awarded by the Department of Defense Production. For unclassified contracts over \$10,000, volume in representative months has ranged from \$500,000 to \$2.7 million to nearly \$4 million.

During 1954, the Department of Defense Production placed almost 90 percent of its total electronics orders with Canadian firms. Previously, the portion was about 75 percent. However, many of the Canadian firms are sales offices of foreign manufacturers so that

(Continued on p 26)

TUNING FORK  
RESONATORS •  
THE ULTIMATE  
IN PRECISION  
AUDIO  
FREQUENCY  
CONTROL



PHONE OR WRITE for complete information regarding  
component type Tuning Fork Resonators, or  
variously packaged Tuning Fork Frequency Standards.



**PHILAMON LABORATORIES INC.**

90 Hopper Street, Westbury, Long Island, N. Y. EDgewood 3-1700

actual production of these orders took place outside of the country.

► **Companies**—According to Canadian Aviation Electronics, of the 24 radio and tv set manufacturers in Canada, 20 are foreign controlled or owned outright and this is representative of the conditions of ownership in other specialized areas of electronics and its supporting parts industry in Canada.

There are approximately 25,000 production workers employed in the present basic Canadian electronics industry with an annual payroll of over \$75 million, according to Canadian RETMA. The figure does not include workers in telephone and telegraph manufacturing and other associated services.

► **Export**—Following World War II, about 100,000 radios per year were exported by Canadian manufacturers but as countries increased trade controls the total dropped. In 1954 it was down to 16,000 radios per year and 1955 exports were about 10,000 units.

► **Future**—By the end of 1957 it is expected that there will be 3.5 million tv sets in use in Canada. By 1958 sales are expected to rise even higher because the coast-to-coast microwave tv network is scheduled to be in operation.

It is hoped that by early 1957 the CBC will convert its existing transmitting equipment for color to retransmit U.S. color programs.

## FCC Actions

► **Reconvened** at end of August after recess

► **Replied** to Colorado governor Ed Johnson (who has "blessed" operation of unlicensed tv booster transmitters) saying government control of radio must be at the federal level and warned against recurrence of difficulties leading to Radio Act of 1927

► **Postponed** until Nov. 15 the deadline for comments on deintermixture rule-making involving 13 channel shifts

► **Suggested** formation of industry television allocation research committee under RETMA chairman to advise FCC on uhf-vhf problems.

► **Maintained** deadline of Oct. 1 for comments on proposal to shift all tv into uhf channels

► **Invited** to uhf study meeting representatives from NARTB, RETMA, Association of Maximum Service Telecasters, Committee for Competitive TV and Joint Council on Educational TV

► **Relaxed** temporarily requirements regarding spurious emissions from uhf translators to encourage use under limited type approval

► **Granted** first three tv translator construction permits. When built, these uhf repeater stations will extend program coverage of Los Angeles and San Francisco stations.

► **Finalized** rule making relative to marine frequencies in the 2-mc range for the Miami, Florida area and Seattle, Washington

## Isotopes Boost Electronic Instrument Sales

Users of the materials increase five-fold, boosting market for associated electronic equipment

INDUSTRIAL users of radioactive isotopes have increased more than 500 percent within the past five years, widening the sales potential of the field for electronic instruments and equipment by a corresponding amount. According to a survey by the Atomic Industrial Forum, over 1,000 industrial organizations in the U. S. are now using atomic energy byproduct materials in 1,347 different installations.

Radioactive materials supplied by

AEC are used for gaging and control operations in the manufacture of a wide variety of consumer products, ranging from roofing and flooring materials to cigarettes, by more than 400 organizations. In the first six months of this year 304 additional users applied for radioisotopes raising the total to 3,279, according to AEC.

► **Savings**—Some 350 firms are using nuclear by-product materials in radiation inspection of welds and castings and in other metalworking operations. According to estimates by AEC, these and other radioiso-

tope applications now mean an annual saving to industry of \$200 million. AEC estimates that the figure will reach \$1 billion annually within the next ten years.

► **Markets**—Research, development and testing organizations, according to the Forum survey, account for the largest number of isotope user organizations, with manufacturers of electrical equipment, electronics and instrumentation, and the metalworking industry next in order. Other users include companies in almost every industry.

(Continued on p 28)



## The emphasis is shifting

It used to be that you would design an airframe for payload—and provide *minimum* required instrumentation.

The emphasis is shifting.

In this new age of electronic missile guidance and identification, the chicken is now the egg and the cart pulls the horse. Instrumentation comes first—after which a mobile

container is designed that will carry it with greatest efficiency.

This shift finds the sturdy shoulders of Stewart-Warner Electronics braced for the greater load. Stewart-Warner has pioneered in electronics for thirty years. Today, S-W Electronics is pioneering in the stratospheric (see note) electronics of tomorrow.

**STEWART**  
**SW** **ELECTRONICS**  
**WARNER** a Division of Stewart-Warner Corp.  
1300 N. Kostner Ave., Chicago 51, Ill.

**Note:** We have room for a few more GOOD engineers up here.

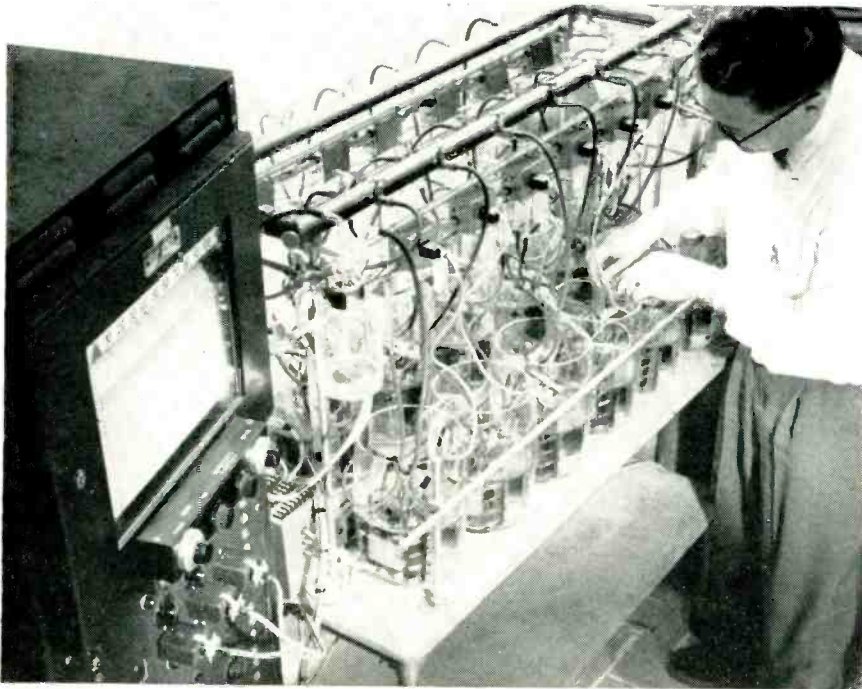

SCIENTIST at National Carbon obtains current from gases in experimental fuel cell as

## Solid State Lures Physicists

Electronics research employs 25 percent of the nation's physicists

ABOUT twice as many physicists are employed in the electronics and electrical machinery field as in any other manufacturing industry. The professional and scientific equipment field, which also includes electronic equipment, is the next highest employer, followed by the chemical field.

About 25 percent of all physicists in the U. S. specialize in electronics regardless of the industry in which they are employed. It is the highest percentage for specialization in any branch of physics. About 15 percent specialize in nuclear physics, the next highest field.

► **Functions**—Most of the physicists in electronics specialize in general electronic research followed by circuits, tubes, microwaves, physical electronics and communications. The remainder specialize in fields ranging from telemetering to fluorescent materials.

In solid-state physics most physicists specialize in general solid-state physics, the physics of metals and in semiconductors, including

transistors. The remainder specialize in solid state fields ranging from magnetism to the physics of gases and high polymers.

► **Jobs**—National Carbon Co. estimates that there are 16,500 physicists in the U. S. and that between 3,000 and 4,000 have specialized in solid-state physics. During the 1930's there were only about 100 physicists in the field. The company sees the possibility within the next decade that the demand for specialists in solid-state fields will double.

► **Development**—Although the transistor is the most publicized product of solid-state research to date there are other developments that have a similar potential. One is the fuel cell shown, an experimental battery by National Carbon that produces electricity from such gases as oxygen and hydrogen which serve as positive and negative poles respectively.

National Carbon also announced that it has grown in its new Ohio laboratory, single crystals of cadmium sulfide three-eighths of an inch in diameter and several inches long using newly-developed research techniques.

## VORTAC Unites VO.

Compromise recommendations implements aim of common system

CONTROVERSY over the radio-frequency spectrum commitments of the military's and CAA's VOR-DME radio navigation systems has been resolved by decision of the Air Coordinating Committee to adopt VORTAC, which combines features of both.

► **Implementation**—Until now, U. S. pilots have looked to VOR (vhf omnidirectional range) for directional information and to DME (distance measuring equipment) for their actual mileage from a given station. Features of the display equipment make it possible to tie in with ILS (instrument landing system) at some economy of space, weight and dollars.

To date, no appreciable quantity of DME transmitting or receiving equipment has been put into service. There are from 100 to 300 DME receivers installed and effort will be made to retain existing DME transmitters until 1960.

► **Tactical Use**—TACAN (tactical air navigation) was developed for the military to perform the same functions as those of VOR-DME. Because different electronic techniques were employed, it has been found easier to site TACAN transmitters (ELECTRONICS, p 174, Oct. 1955). Since some frequencies are shared in common by the two systems, it was, for this reason, impossible for both to exist indefinitely.

## Financial Roundup

NINETEEN more companies in the electronics field made net profit reports in the past month. The results were mixed but 13 companies made gains over 1955 periods. Six firms reported profit declines.

Following are the net profits

(Continued on p 30)

**FOR SPATIAL REFERENCE**

**Gyros**

BY

**Greenleaf**

**QUALITY ABOVE ALL!**

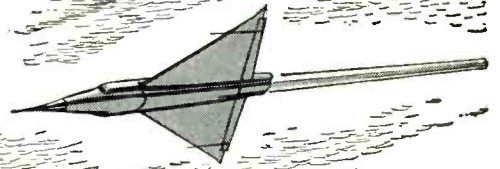

## HIG-5, Model PCK GYRO

### DATA

1. Spin Motor: 9.5 volts, line to line, 400 cps, three phase.
2. Power Required: 4.5 watts @ 0.35 p.f. running.
3. Synchronous Speed: 12,000 R.P.M.
4. Run-up Time: 45 seconds maximum.
5. Angular Momentum:  $1 \times 10^5$  gram-centimeters<sup>2</sup>/second.
6. Gimbal Travel:  $\pm 8^\circ$  maximum.
7. Signal Generator Sensitivity: 72 millivolts/milliradian with 200 milliamperes, 400 cps excitation.
8. Signal Generator Null Voltage: 21 millivolts maximum.
9. Signal Generator Linearity Deviation:  $\pm 1\%$ .
10. Torque Generator Sensitivity: 44 dyne-centimeters/milliamperes<sup>2</sup> ( $\tau$  type, direct current).
11. Torque Generator Linearity Deviation:  $\pm 1\%$ .
12. Input Rate: 0.029 to 57.3 degrees/second.
13. Characteristic Time Constant: 0.0024 seconds.
14. Drift Rate: 5 degrees/hour maximum.
15. Output Angular Rate, Input Angular Rate Ratio: 1.0.
16. Heater Power: 225 watts total from one 75 watt and one 150 watt section, 28 volts direct current.
17. Operating Temperature: 167° F. (75°C).
18. Weight: 3 pounds.
19. Single Degree of Freedom.
20. Viscous Damped.

**NOTE:** This Gyro can be readily modified to meet your requirements. We invite inquiries listing specifications.

The Greenleaf Line of Gyros and associated devices is being steadily expanded. It now includes a wide selection of Free and Rate Gyros, and the HIG-3 and HIG-4 Gyros.

**ENGINEERING • DEVELOPMENT • PRODUCTION**

Write, wire or phone for further information.

THE

**Greenleaf**

**MANUFACTURING COMPANY**

A Division of **MANDREL INDUSTRIES, INC.**

### ENGINEERS WANTED

Greenleaf offers unusual opportunities for mechanical and electrical engineers.

7814 W. Maplewood Industrial Court • Saint Louis 17, Missouri  
Producers of the HIG-3 and HIG-4 Gyros, Rate and Free Gyros, Differential Pressure Mach Meters, Air Speed Indicators, Computers, Switches and many other precision-built components.

GRE-66

of the companies for the fiscal periods indicated:

Company	Net Profit	
	1956	1955
Admiral 6m	\$1,748,055	\$1,946,192
Am. Bosch Arma 6m	2,228,281	2,367,282
Am. Cable & Radio 6m	573,449	404,732
Am. Electronics 6m	185,412	144,161
Amphenol 6m	626,446	442,984
Applied Science 6m	73,400	227,800
Burroughs 6m	6,303,428	4,760,626
CBS 6m	5,308,990	6,327,672
Curtiss-Wright 6m	20,452,133	15,065,859
Edo Corp. 6m	309,000	203,000
Eitel-McCullough 6m	817,167	351,994
High Voltage 6m	78,765	52,173
Lear 6m	1,017,044	876,366
Electronic Eng. 6m	50,965	30,744
National Co. 6m	52,425*	88,405*
Sperry Rand 6m	10,062,046	9,027,895
Texas Instruments 6m	1,029,847	696,010
Tung-Sol 6m	1,296,654	1,528,792
Varian Assoc. 9m	223,007	234,215

## Movie Makers Use More Electronics

Equipment reduces retakes and capital investment requirements while maintaining quality

TELEVISION and radio equipment is helping the motion picture industry to reduce production costs. Extensive retakes that absorb production time and dollars are cut through use of the equipment.

► **Video**—Use of industrial tv by a piggy-back system of attaching an itv camera to a film camera has been used experimentally. This idea has been carried a step further in Du Mont's Electronicam system which unites a Mitchell 35-mm motion picture camera with an image-orthicon tv camera through a common optical system so that parallax is eliminated and an identical picture goes to each unit.

► **Equipment**—All equipment is contained in a pair of trailers that can be moved from studio to studio and set to set. This reduces the capital investment required in permanent stage installations.

► **Cost**—The system will be leased to movie studios at from \$1,500 to \$3,000 a week depending on facilities required. A Du Mont field engineer will accompany each mobile system.

The unit shown has been leased to the Paramount-Sunset Studios in Hollywood. Du Mont expects 15 mobile units to be in use by the end of 1957.

## Meetings Ahead

Oct. 1-3: IRE Canadian Convention, Automotive Bldg. Exhibition Park, Toronto.

Oct. 1-3: Twelfth Annual National Electronics Conference, Hotel Sherman, Chicago.

Oct. 1-4: Semiconductor Symposium Electrochemical Society, Statler Hotel, Cleveland.

Oct. 1-5: AIEE Fall General Meeting, Morrison Hotel, Chicago, Ill.

Oct. 3: AIEE program, New Concepts In Control Systems, Wednesday evenings through Dec. 19, Westinghouse Auditorium, New York, N. Y.

Oct. 8-12: SMPTE 80th Convention, Ambassador Hotel, Los Angeles, Calif.

Oct. 8-9: Second National Symposium on Aeronautical Communications, IRE, Hotel Utica, Utica, N. Y.

Oct. 10-11: Engineering Convention of the Central Canada Broadcasters Association, Seaway Hotel, Toronto.

Oct. 10-12: Third National Symposium On Vacuum Technology, Committee On Vacuum Techniques, Sheraton Hotel, Chicago, Ill.

Oct. 11: IRE, AIEE Creative Engineering Symposium, six lectures to be presented on Thursday evenings through Nov. 13, University Museum Auditorium, Phila., Pa.

Oct. 11-12: URSI Fall Meeting, University of California, Berkeley, Calif.

Oct. 15-17: Radio Fall Meeting, IRE, RETMA, Hotel Syracuse, Syracuse, N. Y.

Oct. 16-18: Conference On Magnetism & Magnetic Materials, IRE, AIEE, APS, AIMME, Hotel Statler, Boston, Mass.

Oct. 18-19: AMA Conference, Organizing Research And Engineering For Profit, Statler Hotel, New York, N. Y.

Oct. 22-23: Fall Meeting of Assembly, Radio Technical Commission for Aeronautics, Hotel Marriott and CAA Technical Development Center, Indianapolis, Ind.

Oct. 25-26: Second Annual Technical Meeting of the IRE Professional Group on Electronic Devices, Shoreham Hotel, Washington, D. C.

Oct. 29-30: East Coast Aeronautical & Navigational Conference, IRE, Fifth Regiment Armory, Baltimore, Md.

Oct. 29-Nov. 2: International Convention On Ferrites, British IEE, London, England.

Nov. 7-9: Ninth Annual Conference On Electrical Techniques In Medicine And Biology, IRE, AIEE, ISA, Gov. Clinton Hotel, New York, N. Y.

Nov. 8-9: Kansas City IRE Technical Conference, Town House Hotel, Kansas City, Kan.

Nov. 14-16: Symposium on Optics and Microwaves, IRE, G.W. University, Lisner Auditorium, George Washington University, Washington, D.C.

Nov. 15-16: New England Radio Engineering Meeting, IRE, Hotel Bradford, Boston, Mass.

Nov. 29-30: IRE PGVC Annual Meeting, Fort Shelby Hotel, Detroit, Mich.

Dec. 5-7: Second IRE Instrumentation Conference & Exhibit, Biltmore Hotel, Atlanta, Ga.

Dec. 10-12: Eastern Joint Computer Conference, IRE, AIEE, ACM, Hotel New Yorker, New York, N. Y.

## Industry Shorts

► **Prediction** that next year's tv sets will be four or five inches shorter in depth, made by W. R. G. Baker of GE, is based on the availability of 110-degree deflection angle picture tubes by the end of this year or early next year.

► **Distribution** revenues in the electronics industry should reach about \$2.3 billion this year and should be up to \$3.5 billion in five years, according to D. G. Mitchell, president of Sylvania.

► **Cost** of converting solar energy into electricity by silicon solar cells

should be reduced from the \$600 per watt present cost to about \$30 per watt, according to Hoffman Electronics.

► **Electronic** equipment on the DC-8 jet airliner may weigh as much as one ton and cost \$140,000 more than the entire cost of the prewar DC-3, according to Douglas Aircraft.

► **Price** increases on all of its capacitor lines averaging about 7.5 percent, just announced by GE, were made to cover higher materials and labor costs. Aluminum and steel account for about 23 percent of an average capacitors weight.



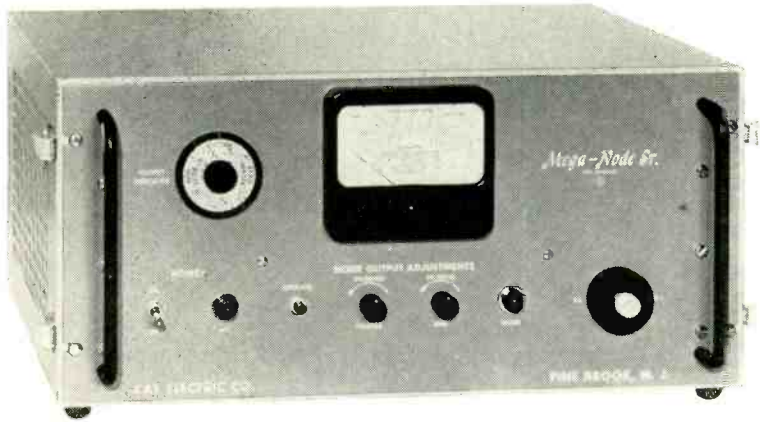

# KAY

## NOISE FIGURE MEASUREMENT 10-3000 MC

### KAY

#### *Mega-Node-Sr.*

- Absolutely no modulation on noise output
- Built-in stability
- Longer life on noise diode
- Ease of operation due to front panel design
- All power supplies regulated

A calibrated random noise source providing an output from 10-3,000 mc, the Mega-Node Sr. may be used to measure noise figure and receiver gain and for the indirect calibration of standard signal sources.

At the lower end of the frequency range noise figure may be obtained directly from the meter. For greater accuracy at higher frequencies, corrections for diode transit time and termination mismatch are available from charts supplied with each instrument.

#### SPECIFICATIONS

- Frequency Range: 10 mc to 3,000 mc
- Output Impedance: 50 ohms unbalanced into Type N Connector
- Noise Figure Range: 0 to 20 db
- Filament Voltage Supply: From regulated supply
- Meter Calibration: Linear in db noise figure; logarithmic in D.C.M.A.
- Fuse Protection: One Type 3AG, 2 amps
- Tubes: 1 Eclipse Pioneer TTI Diode
- Power Supply Source: 117 Watts  $\pm$  10% 60 cps A.C. Available for 50 cps
- Power Consumption: 200 Watts
- Price: \$790.00 FOB Plant

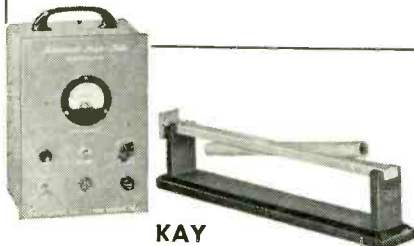

KAY

#### *Microwave Mega-Nodes*

Calibrated random noise sources in the microwave range, used to measure noise figure, and receiver gain and calibrate standard signal sources in radar and other microwave systems. Available in following waveguide sizes to cover range of 960-26,500 mc.

RG-69/U .....	\$400.	†RG-51/U .....	\$195.
†RG-48/U .....	195.	†RG-52/U .....	195.
†RG-49/U .....	195.	RG-91/U .....	250.
†RG-50/U .....	195.	RG-53/U .....	250.

Available with fluorescent or inert gas (argon or neon) tubes. Noise output fluorescent tubes, 15.8 db  $\pm$  2.5 db; argon gas tubes, 15.2 db  $\pm$  1 db\*; neon tubes, 18.0 db  $\pm$  0.5 db\*.

\*Noise output of inert gas tubes independent of operating temperature.

Universal Power supply for both fluorescent or argon gas and all wave-guide sizes: \$100. †\$167. per Guide when 3 or more are purchased with \$100. Power Supply.

NEW! WR-770; WR-650—\$395.00 each; WR-510; WR-430; WR-340—\$495.00 each. All WR numbers fluorescent only.



KAY

#### *Mega-Node*

Calibrated random noise source reading direct in db, for measurement of noise figure, receiver gain and for indirect calibration of standard signal sources. Frequency range, 5 to 220 mc; Output impedances, unbalanced—50, 75, 150, 300, Infinity; balanced—100, 150, 300, 600, Infinity; noise figure range, 0-16 db at 50 ohms 0—23.8 db at 300 ohms.

Price.....\$295.  
FOB plant



KAY

#### *Rada-Node*

Complete radar noise figure measuring set for IF and RF, including attenuators, detector and noise sources. Complete with power supplies. Frequency range: 5 to 26,500 mc; noise figure; range, up to 21 db, in lower part of spectrum. Prices on request.

For Complete Information Regarding These, and Other Kay Instruments, Write:

## KAY ELECTRIC COMPANY

DEPT. E-10

14 MAPLE AVENUE

PINE BROOK, N. J.

CAldwell 6-4000

Another **BH** first

**UL approval for VINYL-GLASS SLEEVING**  
**BH VINYL-SIL 105**

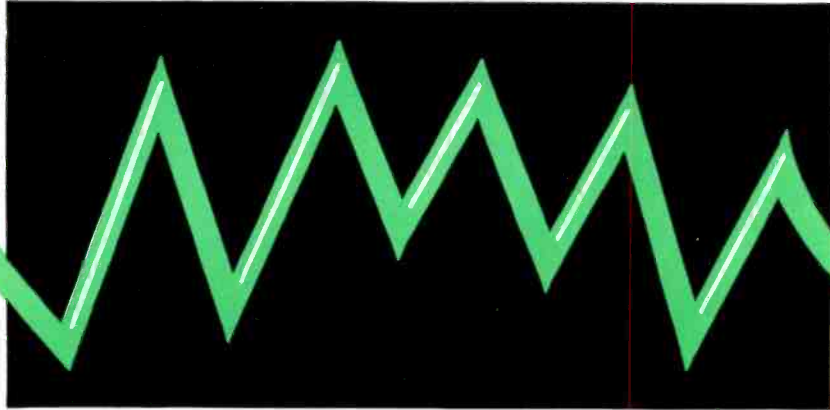

BH Vinyl-Sil 105 is the first vinyl-glass sleeving to be awarded Underwriters' Laboratory approval for operating temperatures of 105°C. Even the best extruded vinyl sleeveings cut-thru when bent over sharp edges. But BH Vinyl-Sil 105's patented Fiberglas braid prevents total cut-thru and reduces the danger of shorting out. Important as it is, UL approval is only one advantage of BH Vinyl-Sil 105. Another is its 8,000 volt *minimum* short-time dielectric breakdown, and here are six more:

- ✓ heat-aging resistance.
- ✓ flow resistance.
- ✓ chemical and oil resistance.
- ✓ abrasion resistance.
- ✓ low temperature flexibility (minus 45°C.)
- ✓ no capillary attraction to water.

BH Vinyl-Sil 105 is available in all colors — on spools, in coils, 36" lengths or in cut lengths on special order — in all NEMA standard sizes. To distinguish it, the product name is printed directly on the sleeving. Data sheets and samples are available FREE. Send for some today and make your own tests.

BENTLEY, HARRIS MANUFACTURING COMPANY  
1310 Barclay Street

CONSHOHOCKEN, PA.

Telephone: TAYlor 8-0634

**BENTLEY, HARRIS**



*Fiberglas*<sup>\*</sup>  
**SLEEVINGS**

**BH . . . first in** use of Fiberglas, heat-treated Fiberglas, true high temperature flexibility, vinyl-coated Fiberglas, silicone rubber coating, colors in silicone rubber, true Class B (130°C.) protection, UL approved vinyl-glass sleeving (105°C.)

\*BH Non-Fraying Fiberglas Sleeveings are made by an exclusive Bentley, Harris process (U.S. Patent Nos. 2393530; 2647296; 2647288). "Fiberglas" is Reg. TM of Owens-Corning Fiberglas Corp.



# Save Time in Circuit Design

Get advance information... in graphic form...  
on vacuum-tube behavior in new circuitry —  
with the **Type 570 Characteristic-Curve Tracer**

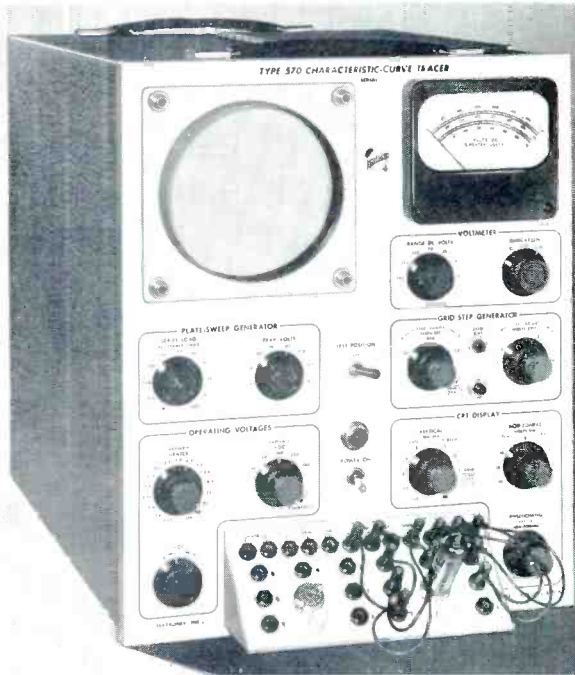

The Tektronix Type 570 Characteristic-Curve Tracer can save you many hours in circuit-development work by providing quick, accurate pictures of vacuum-tube characteristics. You have complete control of the operating-condition setup, permitting a realistic approach to actual circuit conditions, whatever they may be. You get curves that can be very important in a particular circuit problem; but are rarely, if ever, published in handbooks.

The Type 570 can also be used for rapid preselection of vacuum tubes, either by comparison with another vacuum tube, or with curves outlined on a crt mask.

**Please call your Tektronix Field Engineer or Representative or write direct for new booklet, Type 570 Technical Description.**

### Displays Families of Curves on CRT Screen

Choice of four to twelve characteristic curves per family—with as many as 8 positive-bias curves per family.

### Plots All Important Characteristics

Plate current against plate voltage.  
Plate current against grid voltage.  
Screen current against plate voltage.  
Screen current against grid voltage.  
Grid current against plate voltage.  
Grid current against grid voltage.

### Calibrated Controls

Accurate current and voltage readings directly from the crt screen.

### Wide Display Range

11 current ranges from 0.02 ma/div to 50 ma/div.  
9 voltage ranges from 0.1 v/div to 50 v/div.  
11 series-load resistors from 300 ohms to 1 megohm.  
7 grid-step values from 0.1 v/step to 10 v/step.

**Price — \$925**

f.o.b. Portland, Oregon

**ENGINEERS** — interested in furthering the advancement of the oscilloscope? We have openings for men with creative design ability. Write to Richard Ropiequet, Vice Pres., Engineering.

# Tektronix, Inc.

P. O. BOX 831 • PORTLAND 7, OREGON  
Phone CYpress 2-2611 • TWX-PD 265 • Cable: TEKTRONIX

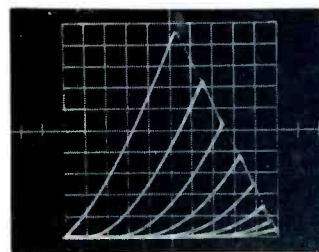

Fig. 1 — Plate current plotted against plate voltage for one triode section of a 12AU7. Plate load is 5 k, peak plate-supply voltage is 500 v. Grid voltage is changed 5 v between curves, from —35 v to zero. Vertical sensitivity is 5 ma/div, horizontal sensitivity 50 v/div. Calibrated controls permit accurate current and voltage readings directly from the screen.

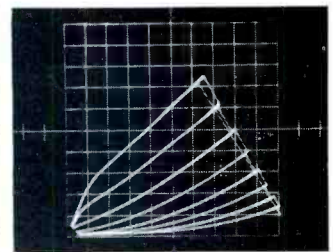

Fig. 2 — Same triode section of 12AU7 with only 20-v peak plate supply and sensitivities increased to 0.2 ma/div vertical and 2 v/div horizontal. Grid voltage is changed 2 v between curves, from —14 v to zero. This is essentially a 25-times magnification of the lower left portion of Fig. 1, showing the operating characteristics at low plate-supply voltage.

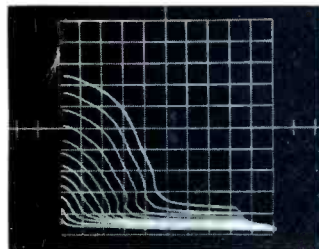

Fig. 3 — Screen current plotted against plate voltage with positive grid bias on a 6AQ5. Plate load is 300 ohms, peak plate voltage is 100 v, screen-grid voltage is 100 v, with grid voltage changing 2 v/step from +16 v to below zero. Vertical scale is 10 ma/div, horizontal scale 10 v/div.

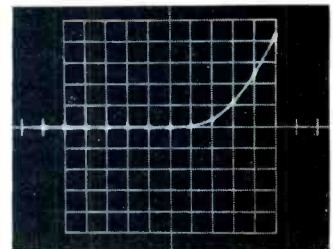

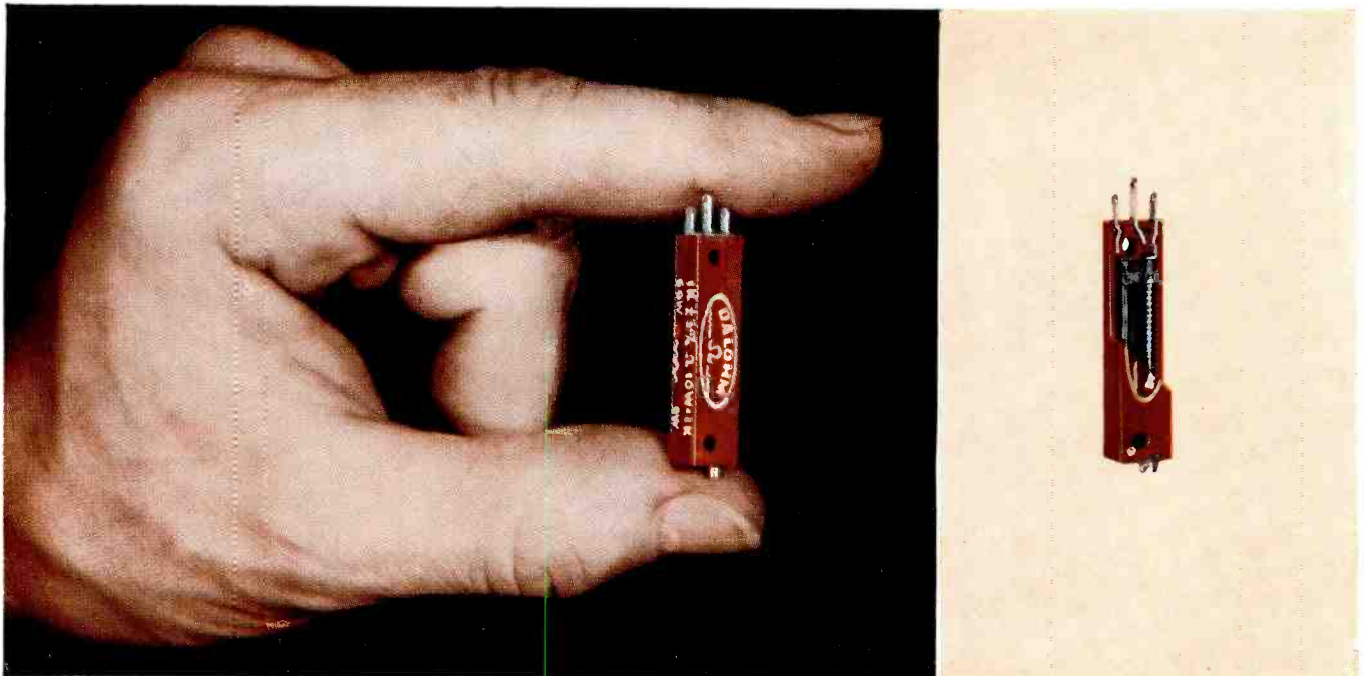

Fig. 4 — Typical Germanium Diode curve. Inherent flexibility of the Type 570 permits accurate evaluation of diode characteristics and detailed examination of any part of the curve. Calibrated scales above are 0.2 v/div horizontal, 0.5 ma/div vertical, with zero points at center of screen.

# Meet the NEW DALOHM

Three new additions to the  line of  
America's finest precision electronic components



PAT. PENDING

**Wire wound, high temperature,  
humidity proof, ruggedized,  
Mil-E-Trized** DALOHM A10-W-TRIMMER POTENTIOMETER

The culmination of four years of research and development, Dalohm A10-W-Trimmer is designed to meet the ever-increasing requirements of MIL specifications such as MIL-E-5272A and MIL-R-12934. It provides precision adjustment in critical electronic circuits under extreme environmental conditions. It has an extended winding surface and assures high precision resolution without sacrificing sub-miniature design. Size is .220 x .310 x 1.250; weight is 2.25 grams.

- Resistance values 10 ohms to 50,000 ohms with standard tolerance of 5%. Power rating 0.8 watt. Temperature coefficient of wire 0.00002/Deg. C. Other resistances, tolerances, and leads available on special order.
- Completely sealed. Housing is of thermosetting, glass filled material with heat resistance of 200° C continuous. Precious metal plating on all metal parts to eliminate corrosion and electrolysis. Air evacuated and replaced with silicone grease to eliminate breathing, moisture, dirt, oxidation and undesirable vibration characteristics.
- Unique new type sliding contact assures continuity at high vibration levels and eliminates slider to lead screw damage.
- Unique safety clutch prevents damage from over-excursion of trimmer adjustment screw.
- Unit holds set resistance values—internal units have nearly identical coefficients of expansion.
- Mounting flexibility provided by two #2-56 mounting screw holes for either stacked or multiple arrangements.

# TWINS...

Hermetically sealed,  
moisture proof, ruggedized  
Mil-E-Trized **DALOHM DP-12 POTENTIOMETER**

for critical electronic circuitry—built to surpass JAN-R-19

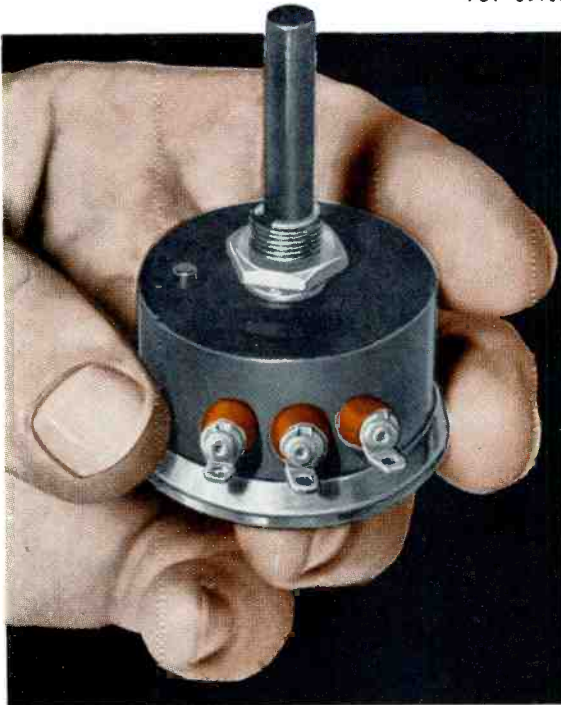

U.S. Patent No. 2526503. British Patent No. 678511. Also Patented in Canada.

Dalohm DP-12 potentiometers are completely protected from arctic cold or tropic damp, from shock, vibration, salt-laden air and ultra-high altitude. The mechanism, winding and contacts are unaffected by atmospheric conditions outside the unit and are able to give the highest performance under extremely adverse conditions.

Powered at 4 watts, the DP-12 has a power rating of 100% at 40° C, derated to 0 at 125° C. Housing and shaft are made of black anodized aluminum with the back plate of corrosive resistant aluminum. The unit is designed for back panel mounting with integral threaded base.

- **OPERATIONAL CHARACTERISTICS**—Operating temperature range is -55° C to 125° C. Minimum rotational life is 25,000 mechanical cycles.
- **WIDE RESISTANCE RANGE**—Standard resistance range is 100 ohms to 40K ohms with standard tolerance of 5%. (Other ranges and tolerances available on special order.)
- **PRECISION WINDING**—Dalohm resistance winding gives excellent linearity with 3% maximum deviation. Resolution is precise with 0.5% maximum.
- **Temperature coefficient of the wire** is 0.00002/Deg. C on values of 500 ohms and up; 0.00C50/Deg. C on values below 500 ohms. Dielectric strength is 1,000 VAC up to 50,000 feet altitude—1000 megohms, minimum.
- **SENSITIVE SHAFT ADJUSTMENT**—Constant shaft torque of 6 inch-ounces, max., throughout operating temperature range provides ease in sensitive adjustment. Effective shaft rotation is 275 degrees minimum. Shafts available screwdriver slotted, flattened or round in lengths of 1/2", 3/4", 1", 1 1/4", 2", and 2 1/2".

## and their power packed little brother...

### Wire-Wound **DALOHM PH-25 POWERHOUSE RESISTOR**

Here is a rugged new resistor for panel mounting. Like all Dalohm resistors, it is carefully designed and skillfully made for all applications where equipment must survive the most severe environmental, shock, vibration, temperature and humidity. Coated with special silicone material and sealed in black anodized finned aluminum housing, Type PH-25 is impervious to moisture, salt ions, vapors and gases.

- Resistance ranges from 0.1 ohm to 15,000 ohms with tolerances of .05% to 5%. Powered at 25 watts.
- Inductive winding; temperature coefficient of wire 0.00002/Deg. C.
- Applicable MIL specifications: Applicable paragraphs of MIL-R-26-B and MIL-R-18546-A (Ships).
- Two terminal lugs; 1 1/4-7 lock nut furnished as standard equipment.



Write for bulletins on these and other



equipment, including wire wound resistors, deposited carbon resistors and collet-fitting knobs

**DALE PRODUCTS, INC.**

1300 28th Ave.,  
Columbus, Nebraska, U.S.A.

In Canada: Charles W. Pointon, Ltd., 6 Alcina Ave., Toronto  
Export Dept.: Pan-Mar Corp., 1270 Broadway, New York

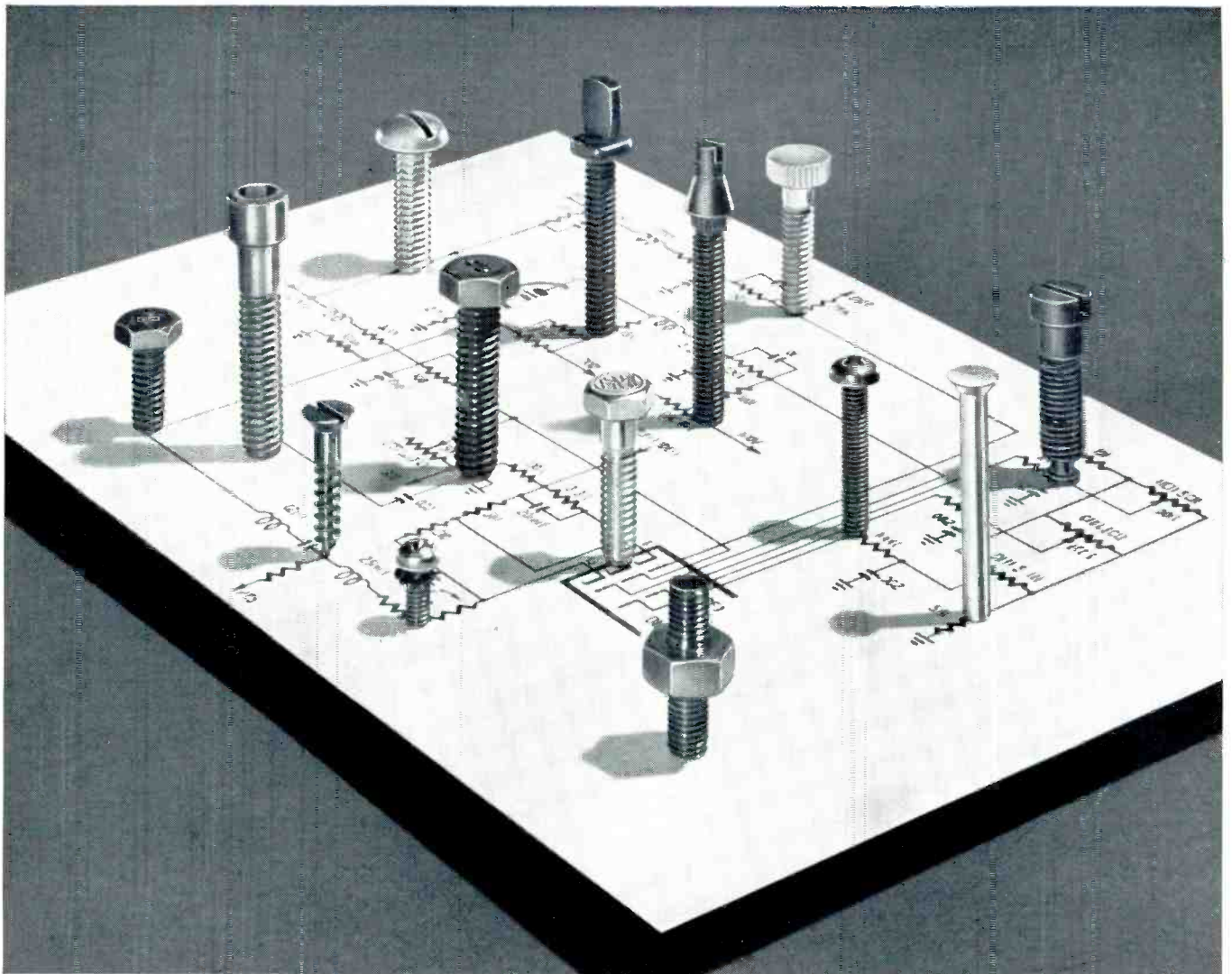

## QUALITY PERFORMANCE *depends on small things*

Manufacturers of electronic equipment recognize that such small things as fastenings are vitally important to the operation of that equipment...to the service that it gives...to the length of life that it serves.

Harper Everlasting Fastenings cost no more and you benefit by:

- The speed of assembly due to the clean threads and precision manufacture.
- The assurance of quality performance due to corrosion resistance and superior strength.
- The improvement in appearance due to the fact that Harper fastenings never rust.

More than 7000 different Harper fastening items are carried in stock in both non-ferrous and stainless steels. See your nearest Harper distributor or write for the Harper catalog.

THE H. M. HARPER COMPANY  
8244 Lehigh Avenue, Morton Grove, Ill.

*If you have a headed part that you are now milling from bar, it will pay you to investigate the Harper Flo-Form® method of producing such parts in quantities economically. Savings range up to 50%. Information on request from a Harper Field Engineer.*

### Specialists in all corrosion-resistant fastenings

Bolts • Nuts • Screws • Rivets • Washers  
of Brass • Bronze • Monel • Aluminum • Stainless

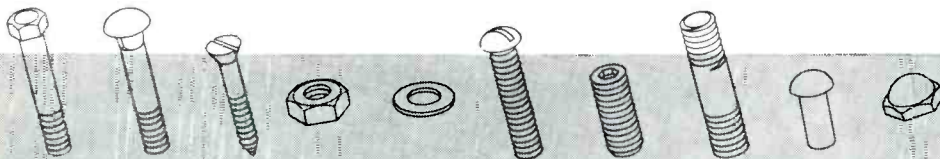

OVER 7000 ITEMS IN STOCK...HARPER DISTRIBUTORS EVERYWHERE



*Everlasting Fastenings*

# in volume production . . .

backed by 5 years' know-how and over 10,000 units in service

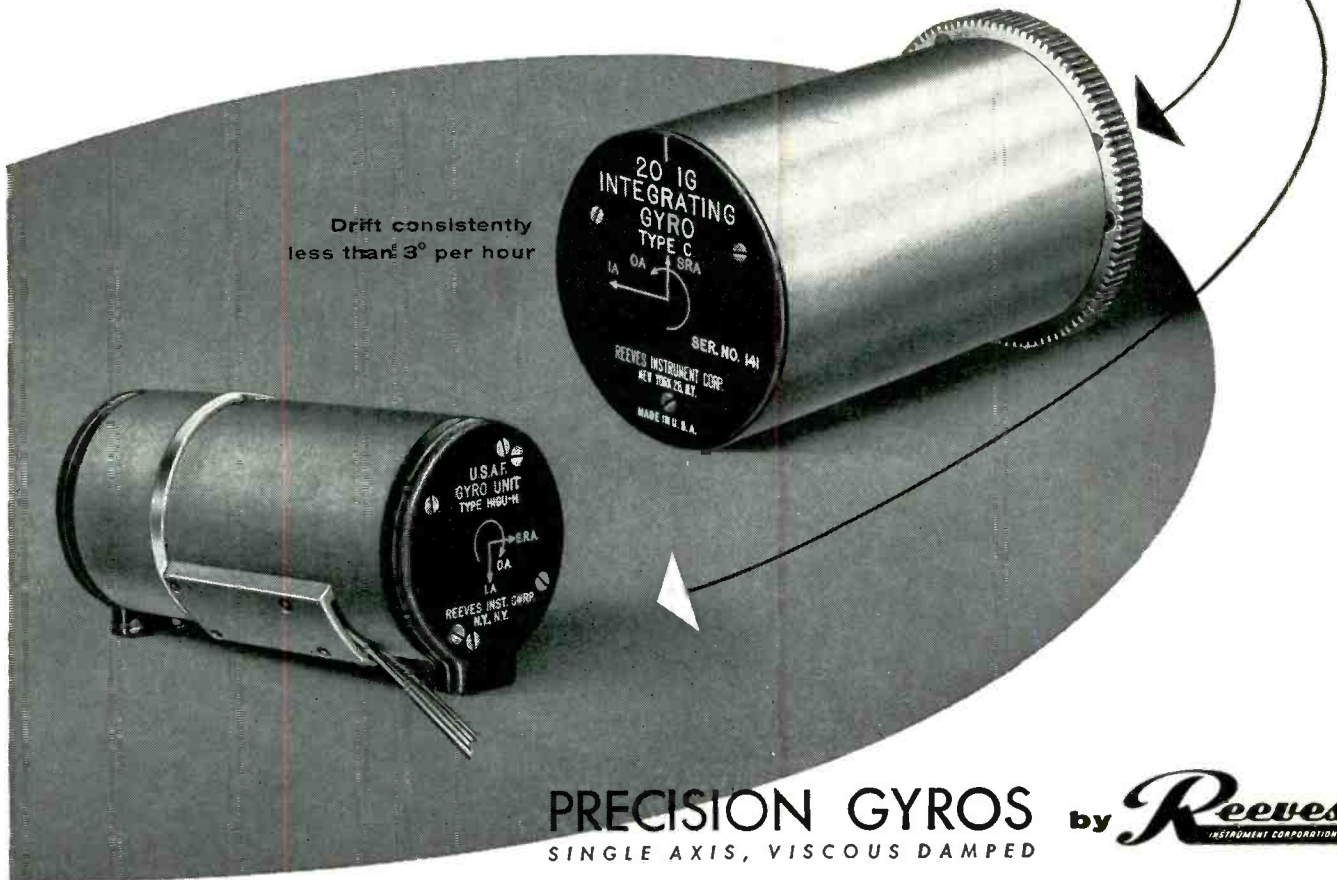

## PRECISION GYROS by *Reeves* INSTRUMENT CORPORATION

SINGLE AXIS, VISCOUS DAMPED

No manufacturer can show a matching record of precision engineering achievement in this most exacting department . . . or better our record of PROVED service in the field. Reeves was one of the first to achieve quantity production to high precision standards of the HIG-5 Gyro . . . the "work-horse" of the gyro field.

Now Reeves has stepped up volume on the new HIG-4 to meet both military and commercial needs . . . with these exceptional features:

- EXTREMELY LOW DRIFT:** Trimmed drift rate less than 3° per hour.
- FULLY FLOATED:** Will withstand over 100 G's shock.
- MASS UNBALANCE:** Less than 0.5 dyne-cm.
- WIDE RANGE:** Signal generator sensitivity and torque generator sensitivity.
- EXTREMELY COMPACT:** Only 2" dia. x 3" long.

Reeves is now ready to meet your requirements with a full range of single-degree-of-freedom, viscous damped rate and integrating gyros and accelerometers, volume produced to exceptional standards in one of the finest gyro facilities in the world. Outline your needs for our recommendations.



REAC Analog Computers



Precision Floated Gyros



Precision Resolvers and Phase Shifters



Servo Mechanical Parts



**REEVES INSTRUMENT CORPORATION**  
A Subsidiary of Dynamics Corporation of America  
201 East 91st Street, New York 28, New York

8RV56



*versatile*

Multi-channel --  
telegraph A1 or  
telephone A3.

FROM GROUND TO AIR OR POINT TO POINT

**STABLE**

High stability (.003%) under  
normal operating  
conditions.

**RUGGED**

**Components  
conservatively  
rated. Completely  
tropicalized.**

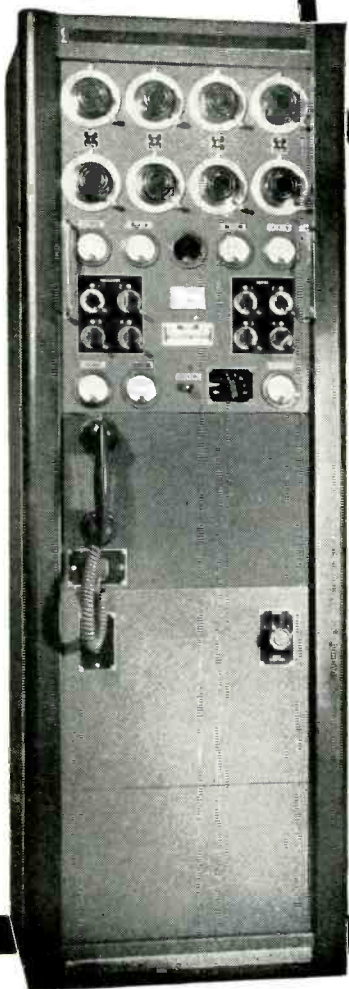

*Model 446 transmitter operates on 4 crystal-controlled frequencies (plus 2 closely spaced frequencies) in the band 2.5-24.0 Mcs (1.6-2.5 Mcs available). Operates on one frequency at a time; channeling time 2 seconds. Carrier power 350 watts, A1 or A3. Stability .003%. Operates in ambient -35° to 45°C. Nominal 220 volt, 50/60 cycle supply. Conservatively rated, sturdily constructed. Complete technical data on request.*

**Here's the ideal general-purpose high-frequency transmitter! Model 446... 4-channel, 6-frequency, medium power, high stability. Suitable for point-to-point or ground-to-air communication. Can be remotely located from operating position. Co-axial fitting to accept frequency shift signals.**

Now! Complete-package, lightweight airborne communications equipment by Aer-O-Com! Write us today for details!

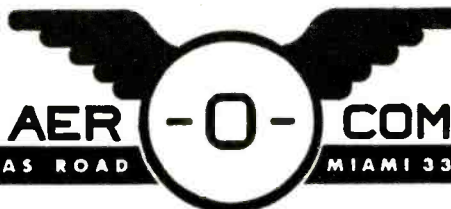

3090 DOUGLAS ROAD

MIAMI 33, FLA.



Raytheon

World's Largest Manufacturer of Magnetrons and Klystrons<sup>®</sup>

# see Raytheon for microwave and special tubes

Here are just six Raytheon Microwave and Special Tubes from the largest, most complete line in the industry. You can add many hours of reliable service to your microwave, radar and special equipment by designating Raytheon Tubes.

Data booklets on Magnetron, Klystron and Special Tubes are available on request - without cost or obligation. Write for your copies today.

For complete details of Raytheon's free Application Engineer Service please contact Power Tube Sales.



**RAYTHEON MANUFACTURING COMPANY**  
Microwave and Power Tube Operations, Section PT-52  
Waltham 54, Massachusetts

**Regional Sales Offices:** 9501 W. Grand Avenue, Franklin Park, Illinois  
622 S. LaBrea Avenue, Los Angeles 36, California

**Raytheon makes:** Magnetrons and Klystrons, Backward Wave Oscillators, Traveling Wave Tubes, Storage Tubes, Power Tubes, Receiving Tubes, Picture Tubes, Transistors.

#### QK464

Storage Tube  
Magnetic Deflection Type  
Resolution—400 lines



#### 6116

Klystron  
Ruggedized  
Thermally Tuned  
Frequency—  
8500 to 9660 mc  
Power Output—  
35 mw



#### RK3B24W

Half Wave-High Vac.  
Diode Rectifier  
Max. Peak  
Inverse Voltage—  
20,000  
Max. Peak  
Current—300 ma

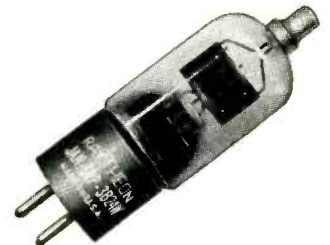

#### QK518

Backward-Wave  
Oscillator  
Frequency Range—  
2000 to 4000 mc  
Voltage Tunable  
Power Output—  
0.1 to 1.0 watts



#### QK329

Square Law Tube  
Function Multiplier



#### RK2J51A

Magnetron  
Tunable—  
8500 to 9600 mc  
Peak Pulse Power—  
40 kw min.



# AMERICAN AIRFREIGHT OFFERS BENEFITS THAT ELECTRONICS EXECUTIVES WANT MOST

When electronics executives use airfreight to get component parts delivered in hours rather than days, they specify American Airlines Airfreight. American is their best assurance of fast, reliable service because of these important reasons:

## COVERAGE

Only American offers the extra speed of direct one-carrier service to seventy-seven leading cities . . . all twenty-three leading industrial states.

## CAPACITY

American has space for your shipments when and where it's needed most. A combined daily lift potential of over a half-million pounds gives American the greatest capacity of any airline.

## FREQUENCY

Shipments get faster forwarding . . . spend less time in terminals with American's greater frequency of schedules. Over 1000 departures daily offer more service to more cities than any other carrier.

## DEPENDABILITY

First with scheduled airfreight, American today has the largest, most experienced personnel force . . . most modern handling facilities. Is better able to solve shipping problems . . . provide dependable on-time deliveries.

# AMERICAN AIRLINES AIRFREIGHT

— carries more cargo than any other airline in the world



## Airfreight costs less than you think

A typical 100 lb. shipment of electronic  
equipment from Chicago to New York  
costs only \$7.50 . . . from Los Angeles  
to Detroit only \$15.10.



# TAYLOR

Laminated Plastics  
Vulcanized Fibre

# Shop Talk

TAYLOR FIBRE CO.  
Plants in Norristown, Pa. and La Verne, Calif.

PHENOL—MELAMINE—SILICONE—EPOXY LAMINATES • COMBINATION LAMINATES • COPPER-CLAD LAMINATES • VULCANIZED FIBRE

## Tips for designers

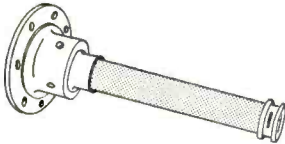

**Aircraft fuel gage tank unit** uses a tube of Taylor epoxy glass base laminate . . . an unusual material noted for excellent corrosion resistance and electrical insulation over a wide humidity range.

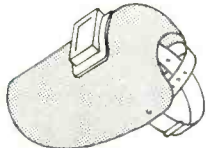

**Welders' helmets** are fabricated from tough durable Taylor vulcanized fibre . . . readily formed to many desired contours.

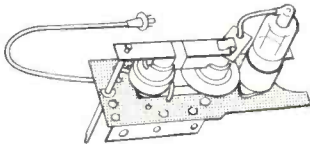

**Base plate** for high-voltage TV component, punched from Taylor canvas melamine laminate, has high dielectric strength and arc resistance.

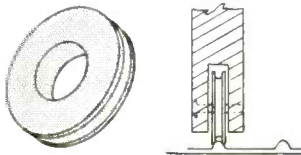

**Rollers** for flush doors are now being made from Taylor paper base tubing with ball bearing insert . . . providing smooth, silent operation at a low cost.

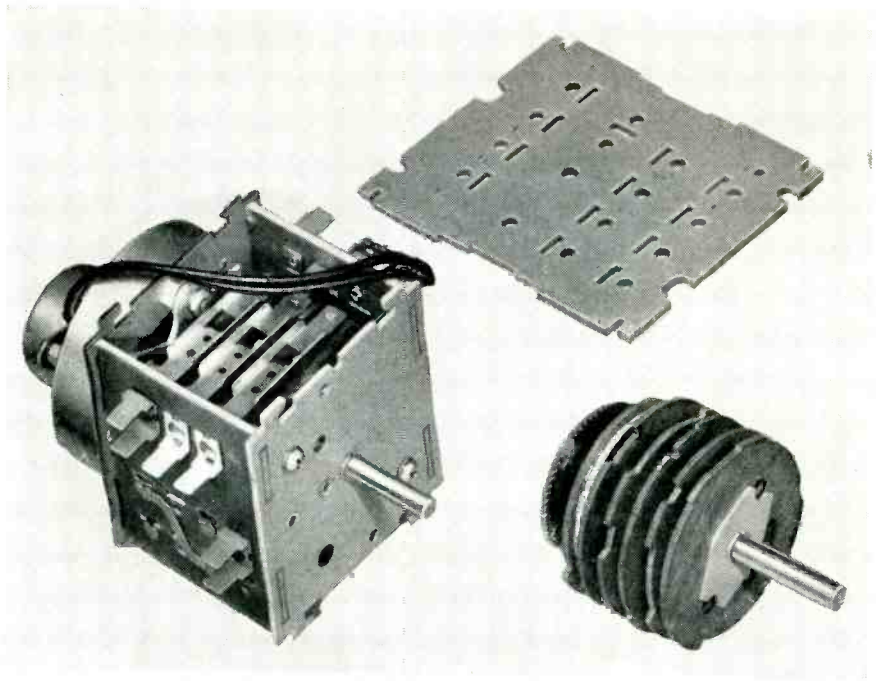

Interval timer switches, made by P. R. Mallory & Co. Inc., use various grades of Taylor paper base phenol laminates for cams and terminal boards. These laminates provide electrical insulation, strength, dimensional stability.

## Tough specifications? check Taylor phenol laminates

Choose from over 30 grades of Taylor phenol laminates, for the combination of electrical, physical, and machining properties you want. These rugged, versatile laminates can meet your most demanding specifications, improve end-product performance . . . and bring you major savings in material and fabrication costs.

These laminates, consisting of a paper, cotton fabric, asbestos, glass cloth or nylon base impregnated with Phenol resins, were developed to meet the need for dependable, moisture resistant insulation. They possess high dielectric and mechanical strength. Unaffected by heat or cold (except extremely high temperatures) they resist oils and most chemicals, and are especially suited to the punching and machining of accurately-sized parts. Because of their high moisture-resistance qualities,

Taylor phenol laminates will not readily warp or become distorted when subjected to alternating wet and dry conditions.

You'll like the way these laminates handle in the shop . . . how they punch and stake cleanly, how they readily machine to hairline tolerances. And you'll like the way they perform in product application, how they retain their original characteristics over long periods of time and under severe operating conditions.

Taylor offers the service of its field specialists to help you choose the grade of material that matches the exact requirements of your application. Check with Taylor now. Write for the general catalog of Taylor materials. And contact your nearest Taylor sales engineer for a discussion of your particular requirements.

### NEW TAYLOR

#### COPPER-CLAD LAMINATES

Taylor GEC (glass-epoxy) Copper-Clad and Taylor XXXP-242 cold punching (paper-phenol) Copper-Clad. Taylor uses high purity rolled copper on base materials with outstanding electrical properties.

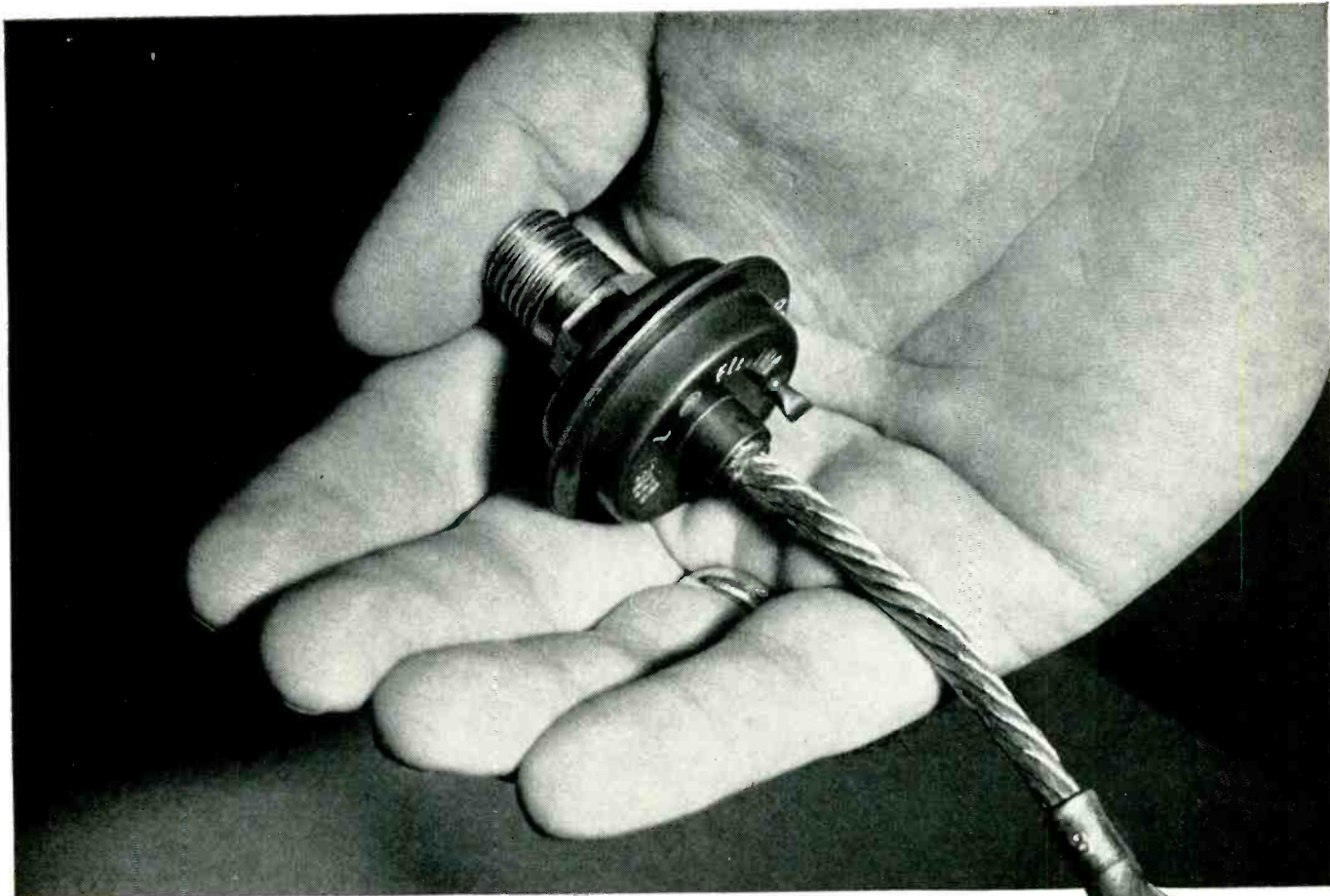

## New General Electric high current silicon rectifier delivers 10 kilowatts at 200° C junction temperature

The new General Electric high current silicon rectifier delivers 10 kilowatts—from a much smaller, rugged, and more compact package. It offers improved efficiency in a wide variety of applications such as jet aircraft, locomotive propulsion motors, and electro-chemical equipment.

### Exclusive General Electric Design

The compact, steel package is hermetically sealed to prevent contamination. The exclusive pipe thread stud design provides best possible thermal connection to the heat sink. As a result: The new General Electric silicon rectifier offers a more efficient and reliable method for converting AC to DC for any application. A full year warranty is your assurance of fine performance.

### Many Possible Applications

The new semiconductor device will prove invaluable for rectification in the new AC distribution systems of modern jet aircraft. In the locomotive

industry, the unit is used to rectify the power supply for traction motors. In the electro-chemical field—for use in electrolysis and plating equipment. Other possible applications include computer power supplies and DC central station telephone power supply equipment.

### Your G-E Man Has The Details

Ask your G-E Semiconductor Specialist for the full technical characteristics, ratings, and specifications together with production and delivery information. Or, write today to: *General Electric Company, Semiconductor Products, Section X4106, Electronics Park, Syracuse, New York.*

### TYPICAL APPLICATION GENERAL ELECTRIC HIGH CURRENT SILICON RECTIFIER

CIRCUIT	Three Phase Bridge Rectifier, Resistive Load.
D-C OUTPUT	280 volts, 215 amperes, 60 kilowatts.
RECTIFIER LOSSES	Less than one percent (½ KW).
COOLING REQUIRED	One 6½ inch square ⅛" thick copper fin for each of six rectifying units when used with 2000 fpm 30°C forced air. Free convection cooling may be utilized by increasing the fin area.
VOLUME	Total volume of rectifiers and fins—less than ⅓ of a cubic foot.

*Progress Is Our Most Important Product*

**GENERAL  ELECTRIC**

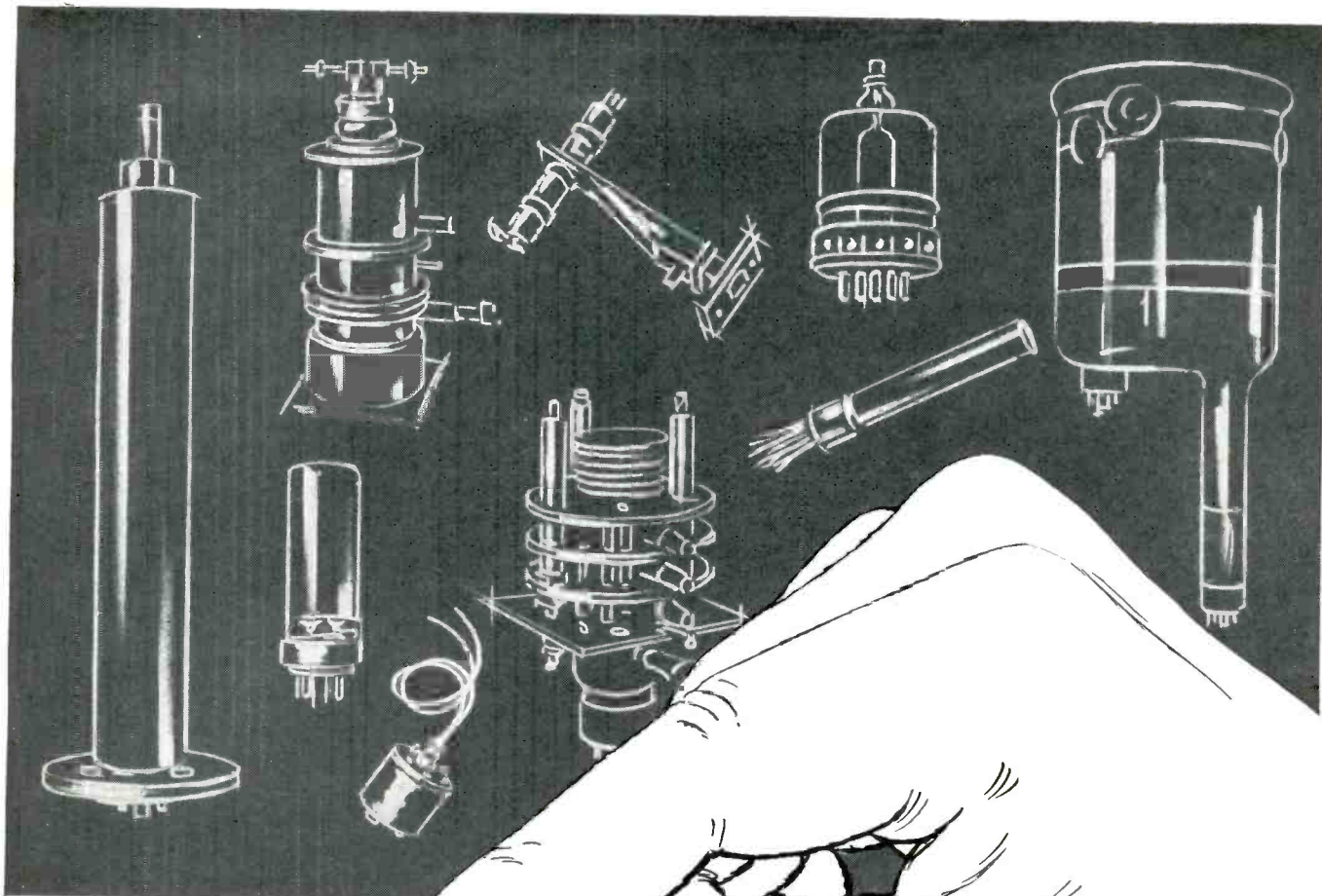

For  
critical  
applications...

## NON-POROUS Tube Element Supports of *Linde* SAPPHIRE

LINDE Industrial Sapphire provides several outstanding advantages when used for tube element supports and spacers in microwave tubes and related equipment. LINDE sapphire is a *single* crystal of 100% aluminum oxide, optically clear, and having zero per cent porosity. There are no outgassing problems. Its dielectric constant is 11.0 at 10,000 megacycles. It has excellent ultra-violet and infrared transmission characteristics. Seals can be made to metals as well as to glass and ceramics.

Tube supports of LINDE sapphire are particularly suitable for klystrons, magnetrons, backward wave oscillators, electron guns, and similar devices. LINDE sapphire is available in the form of windows, rods, balls, tubes, and special shapes.

Detailed information regarding physical and electrical characteristics of LINDE sapphire is available on your request. LINDE engineers will be glad to discuss your applications with you. Write to "Crystal Products Dept. BD-10."



**LINDE AIR PRODUCTS COMPANY**

*A Division of Union Carbide and Carbon Corporation*

30 East 42nd Street  New York 17, New York

*In Canada: Linde Air Products Company, Division of Union Carbide Canada Limited, Toronto*

The term "Linde" is a registered trade-mark of Union Carbide and Carbon Corporation.

**NEW**

**MARSHALL HEADQUARTERS**

**OFFERS INSTRUMENT AND  
COMPONENT CUSTOMERS FASTER,  
MORE COMPREHENSIVE SERVICE**

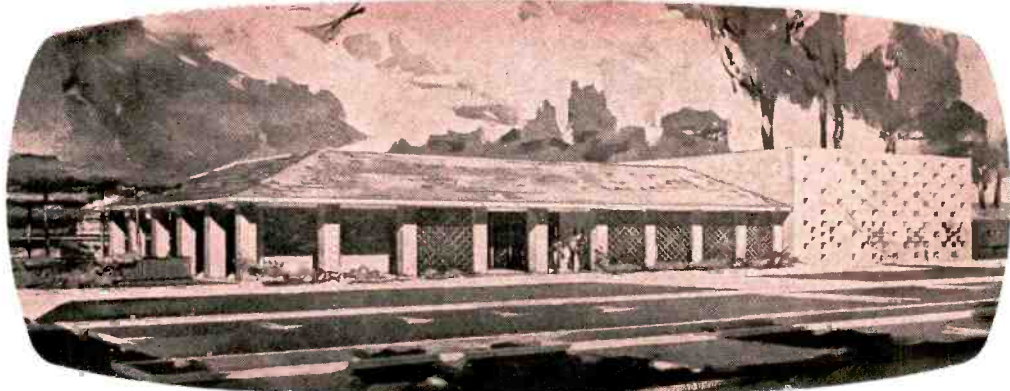

Expanding to fully integrated main offices in San Marino, Calif., the G. S. Marshall Co., Manufacturers' Representatives, offers broader, better facilities to the electronic and aircraft industries. Now available under one roof are the following services:

*Stocking facilities for supplying small quantities quickly.*

*Demonstration rooms—where you can choose from several alternates.*

*Facilities for housing the field demonstration bus.*

*Instrument service department—for warranty and other service work.*

*Literature and prices supplied promptly, on all items sold through Marshall.*

**G. S. MARSHALL CO.**



*"Marshall of the West"*

**MANUFACTURERS' REPRESENTATIVES**  
2065 Huntington Drive, San Marino, Calif., RYan 1-9663  
NORTHERN CALIFORNIA: 2015 El Camino Real, Redwood City • EMerson 6-8214  
ARIZONA: 3686 Baker Place, Tucson • TUCson 7-1501

"Marshall  
of the  
West"



Represented in California, Arizona and New Mexico by

**G. S. MARSHALL CO.**

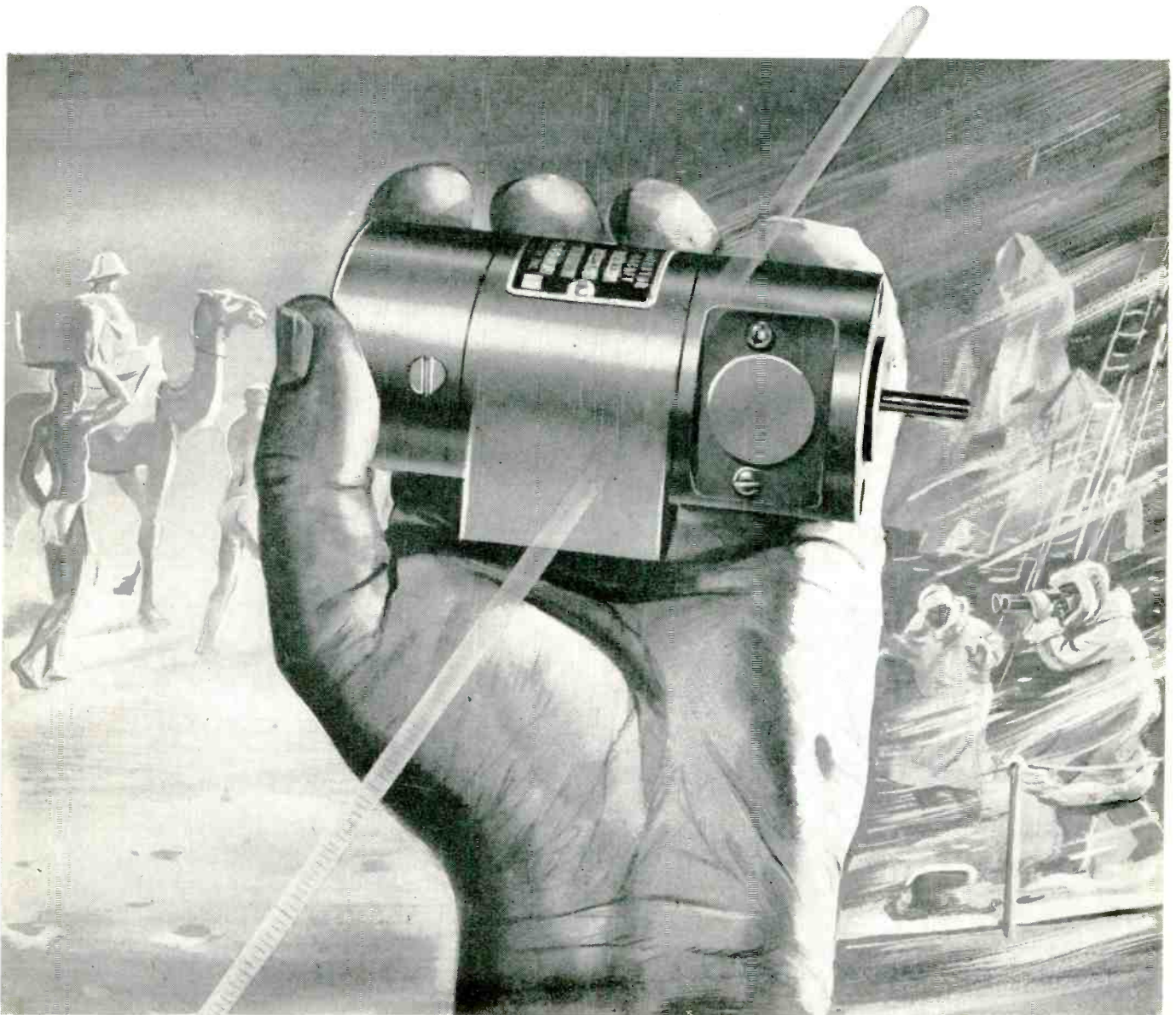

## ENTIRELY NEW!

### temperature compensated DC tach generators

Now, for the first time, you get precise speed measurement, simply and without having to make the usual temperature corrections. ELINCO's new line of temperature-compensated DC tach generators, available in two types, provides outputs held to within  $\pm 0.1\%$  or to  $\pm 0.25\%$  voltage variation due to temperature change, over a range of  $-40^{\circ}$  to  $+100^{\circ}\text{C}$ . This amazing accuracy, compared to the 5%-7% variation encountered in

uncompensated units, eliminates the need for external corrective networks, reduces cost, and simplifies installation in any application calling for precise visual or automatic speed control. These new time and money-saving ELINCO generators are custom-made to individual specifications in six basic frame and mounting types. Available outputs for operating speeds up to 10,000 rpm and from 1 to 175 volts per 1,000 rpm.

#### OTHER ELINCO CUSTOM-BUILT COMPONENTS

**HYSTERESIS MOTORS** — outstanding for greater output per watt input — single, 2, 3, and 5-speed types, sizes to 1/8 hp.

**TORQUE MOTORS** — designed for continuous or intermittent stall conditions. Continuous stall torques to 80 oz. in. — intermittent duty to 225 oz. in.

Plus over 1,000 basic models of precision instrument-type components including:

- AC & DC GENERATORS
- COMMUTATOR MOTORS
- INDUCTION & TORQUE MOTORS
- SELF-SYNCHRONOUS MOTORS
- SYNCHRONOUS MOTORS
- SPECIAL APPLICATION UNITS

Free detailed catalogs on request

**ELINCO**

**ELECTRIC INDICATOR COMPANY, INC.**  
111 Camp Avenue  
Stamford, Conn.





## Non-Linear Dinner

What a bill of fare! Seventy-five standard† non-linear precision potentiometers . . . six of them in stock . . . available for your prototype electromechanical system.

The service is excellent. No waiting, no cover, no minimum • And that's just the table d'hote menu . . . to satisfy your breadboard appetite • To order a la carte, send us your empiricals. We'll feed them into our digital computer . . . to save hungry hours and eliminate human error . . . to check for practicability of manufacture . . . and to confirm the points in your data curve. Then, before you can say, "HELIPOT\* custom-made non-linear potentiometer", you'll have one on the table!

†Standard functions include:

360° sine-cosine		single-sided square
360° sine or cosine		double-sided square
180° sine		20 db log
90° sine		40 db log
tangential ± 75°		50 db log

... available in nine series of  
single-turn and multi-turn potentiometers

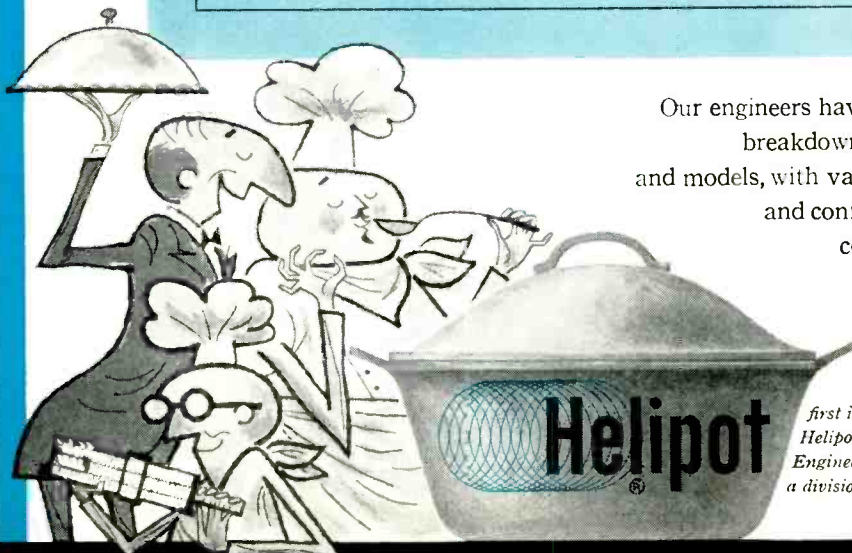

Our engineers have cooked up a detailed breakdown of standard functions and models, with varying resistance ranges and conformities. Send for your copy, It's data file 1021.

first in precision potentiometers  
Helipot Corporation, Newport Beach, California  
Engineering representatives in principal cities  
a division of Beckman Instruments, Inc.

"Marshall  
of the  
West"



Represented in California, Arizona and New Mexico by

**G. S. MARSHALL CO.**

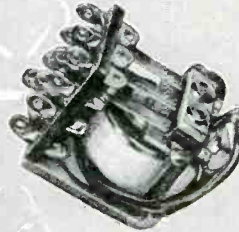

# NEW! SUB-MINIATURE 3-POLE P & B RELAY FOR MULTIPLE SWITCHING

### KM SERIES

#### ENGINEERING DATA

##### CONTACTS:

Max. 3PDT. 3/32" Dia. Silver  
2 amps, 115V 60 cy. resistive

##### VOLTAGE RANGE:

Up to 48V DC nominal

##### COIL RESISTANCE:

Up to 6700 ohms

##### COIL POWER REQUIREMENT:

1 watt

##### TEMPERATURE RANGE:

-45° C to +55° C

##### PULL-IN:

75% of nominal voltage

##### TERMINALS:

Solder lugs

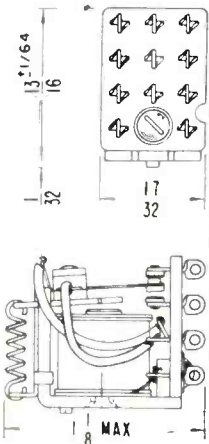

This new P&B KM series was engineered to meet the pressing demand for miniaturization and multiplicity of action within a single relay. Application possibilities cover a wide field of diverse products, such as:

#### SMALL BUSINESS MACHINES

ALARM SYSTEMS

INTERCOM SYSTEMS

AUTOMATIC TOYS

REMOTE CONTROLS

Here is only one of the great family of P&B relays . . . one of more than 20,000 design variations. Custom modification of relays, too, is a P&B specialty. Thus you have one dependable source for ALL your relay needs!

KM RELAY ABOVE SHOWN ACTUAL SIZE

**P&B STANDARD RELAYS ARE AVAILABLE AT MORE THAN 500 DISTRIBUTORS IN ALL PRINCIPAL CITIES**



# Potter & Brumfield PRINCETON, INDIANA inc.

SUBSIDIARY OF AMERICAN MACHINE AND FOUNDRY COMPANY

Represented in California, Arizona and New Mexico by

# G. S. MARSHALL CO.

"Marshall  
of the  
West"



Now! For

## Tensolite

customers in  
the Far West!

### COMPLETE SALES, ENGINEERING AND WAREHOUSE SERVICE ON THE WEST COAST

Tensolite field engineers are strategically located to provide you with fast and efficient service!

In Northern California

G. S. MARSHALL COMPANY  
2015 EL CAMINO REAL  
REDWOOD CITY, CALIF.  
Telephone: EMerson 6-8214



In Southern California

G. S. MARSHALL COMPANY  
2065 HUNTINGTON DRIVE  
SAN MARINO, CALIFORNIA  
Telephone: RYan 1-9663



And our new

### TENSOLITE PACIFIC DIVISION IN LOS ANGELES

Including a new government bonded warehouse fully equipped to make off the shelf shipments of source inspected wire and cable. Phone, or write for fast service on your wire and cable requirements!

## Tensolite

OFFICE AND WAREHOUSE  
1516 NO. GARDNER STREET  
LOS ANGELES 46, CALIF.  
HOLLYWOOD 5-6060

### In Teflon® Hook-up Wire...

# ONLY Tensolite MAKES ALL

# 3

**1. EXTRUDED TEFLON** insulation featuring greater abrasion resistance in a rugged construction, available in sizes 10 through 30 AWG in 14 solid colors or spirally striped.

**2. PARALLEL WRAPPED TEFLON** insulation utilizing our exclusive patented technique which provides longest continuous lengths, greater cut-thru resistance and maximum flexibility. Sizes 20 through 34 AWG, in 14 solid colors.

**3. SPIRAL WRAPPED TEFLON** insulation with special cross-lapped construction and unlimited color coding, with striping that meets commercial (GEN-104) and military (MIL-W-76A) specifications. Sizes 8 through 30 AWG.



© D. Pan

**-and all three Tensolite Hook-up Wire constructions are in accordance with MIL-W-16878A, Types E and EE!**

Call your local Tensolite field engineer\* for assistance in selecting the particular Teflon wire construction to meet your specific requirements — or call directly on Tensolite's extensive engineering facilities for the design, development and production of your custom-engineered wire and cable needs. Catalog sent on request.



**Tensolite Insulated Wire Co., Inc.**  
198 MAIN ST., TARRYTOWN, NEW YORK — Tel. MEEdford 1-2300

NEW ENGLAND  
HATHAWAY ELEC. INC.  
238 Main St.  
Cambridge 42, Mass.

MEET. N.Y., NORTH N.J.  
REED & RIDDETT CO.  
1106 Jericho Turnpike  
New Hyde Park, N.Y.

UPSTATE N.Y.  
WILSON W. ZIMMERMAN, INC.  
112 Dewitt St.  
Syracuse 3, N.Y.

SOUTH N. J., E. PENNA.  
MASSEY ASSOCIATES  
529 Bronckhurst Ave.  
Narberth, Pa.

#### \*TENSOLITE FIELD ENGINEERS

DEL., MD., VA., D.C.  
MASSEY ASSOCIATES  
1 Thomas Circle, N.W.  
Washington 5, D.C.

N.C., S.C., TENN., MISS., ALA., GA., FLA., LA.  
HART ENG. & SALES CO.  
132 Walker St., S.W.  
Atlanta, Ga.

OHIO, W. PA., SO. IND., KY.  
SHERIDAN ASSOC.  
Roselawn Center Bldg.  
Cincinnati 37, Ohio

NO. ILL., NO. IND., W. MICH.  
JERRY COLTEN CO.  
2750 W. North Ave.  
Chicago 47, Ill.

IOWA, SO. ILL., MO., KAN.  
ENGINEERING SERV. CO.  
4550 Main St.  
Kansas City, Mo.

WISCONSIN  
E. A. DICKINSON & ASSOC.  
744 N. Fourth St.  
Milwaukee 3, Wisc.

MINNESOTA  
FRED PETERSON CO.  
2431 Hennepin Ave.  
Minneapolis, Minn.

ARK., OKLA., TEXAS  
EDWARD F. AYMOND & CO.  
4312 Maple Ave.  
Dallas 19, Texas

WASH., ORE., IDAHO, MONT.  
M. K. WIDDEKIND CO.  
216 First Ave. N.  
Seattle 9, Wash.

WY., COLORADO  
FRANKLIN SALES CO.  
1219 California St.  
Denver, Colorado

CALIF., ARIZ., N. MEX.  
G. S. MARSHALL CO.  
40 So. Los Robles  
Pasadena 1, Calif.

CANADA  
AEROMOTIVE ENG. PRODS.  
5257 Queen Mary Rd.  
Montreal, Quebec  
P.O. Box 760  
Brampton, Ontario

EXPORT  
Ad. ADRIEMA, INC.  
871 Broad St.  
New York, N.Y.

"Marshall  
of the  
West"



Represented in California, Arizona and New Mexico by

**G. S. MARSHALL CO.**

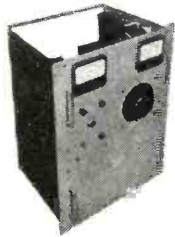

**GERMANIUM RECTIFIER  
D-C POWER SUPPLIES**

240 stock models available from  
0-10 volts, 0-4 Amperes DC, to  
0-160 volts, 0-100 Amperes DC,  
with or without line regulators.  
Catalog E-5

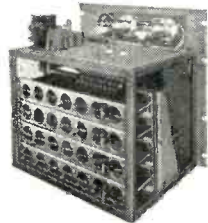

**THYATRON-REGULATED  
HIGH-CURRENT D-C  
POWER SUPPLIES**

120 stock models available from  
4-10 volts, 0-4 Amperes DC, to  
64-160 volts, 0-100 Amperes DC.  
Catalog E-5

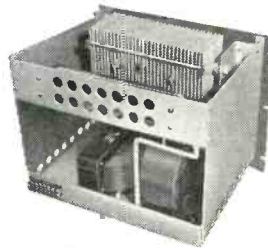

**SELENIUM RECTIFIER  
D-C POWER SUPPLIES**

240 stock models available from  
0-10 volts, 0-4 Amperes DC, to  
0-160 volts, 0-100 Amperes DC,  
with or without line regulators.  
Catalog E-5

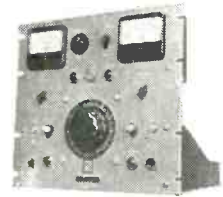

**HIGH VOLTAGE  
POWER SUPPLIES**

77 stock models available from  
0-2.5 KV at 0-2 ma DC, to 0-120  
KV at 0-5 ma DC. Intermediate  
voltage ranges to 200 ma.  
Catalog H-5



**ZERO-LAG D-C  
POWER SUPPLIES**

120 stock models available from  
4-10 volts, 0-4 Amperes DC, to  
64-100 volts, 0-100 Amperes DC.  
Catalog E-5

*all  
this  
and  
custom, too!* ▶▶▶▶

*881 stock models available from NJE . . .*

**POWER  
SUPPLIES  
UNLIMITED**

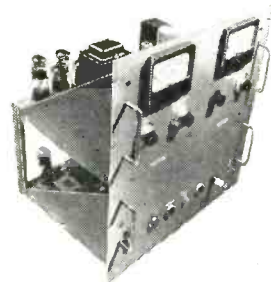

**CHOPPER-STABILIZED STANDARD  
CELL REFERENCE SUPER-  
REGULATED POWER SUPPLY**

Stability, 50 parts per million. Set-  
ability, 100 parts per million. Custom  
Design File Available.



**LABORATORY GRADE  
REGULATED PLATE  
POWER SUPPLIES**

16 stock models available from  
0-300 volts, 0-300 ma, to 0-600  
volts, 0-600 ma. Catalog L-5



**STANDARD GRADE  
DUAL REGULATED  
PLATE POWER SUPPLIES**

20 stock models available from  
0-650 volts, 0-200 ma, to 0-1200  
volts, 0-600 ma. Catalog S-5



**STANDARD GRADE  
REGULATED PLATE  
POWER SUPPLIES**

32 stock models available from  
200-325 volts, 0-100 ma, to 0-600  
volts, 0-300 ma. Catalog S-5

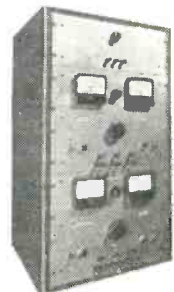

**LABORATORY GRADE  
DUAL REGULATED  
PLATE POWER SUPPLIES**

16 stock models available from  
0-600 volts, 0-600 ma, to 0-1200  
volts, 0-1200 ma. Catalog L-5



WRITE FOR COMPLETE OR SPECIFIC CATALOG MATERIAL.

**NJE CORPORATION**

ELECTRONIC DEVELOPMENT & MANUFACTURING

345 Carnegie Ave., Kenilworth, New Jersey

Represented in California, Arizona and New Mexico by

**G. S. MARSHALL CO.**

"Marshall  
of the  
West"



## FOR HIGH RELIABILITY PROJECTS ONLY!

(Environmental production testing optional, but recommended)

Details upon request

- Hermetically Sealed Deposited Carbon Resistors
- Encapsulated Precision Wire Wound Resistors
- Sealed Resistor Networks

**MEPCO INC., MORRISTOWN, NEW JERSEY**

"Marshall  
of the  
West"



Represented in California, Arizona and New Mexico by

**G. S. MARSHALL CO.**

# THE MOSELEY **AUTOGRAF** trade mark X-Y RECORDER

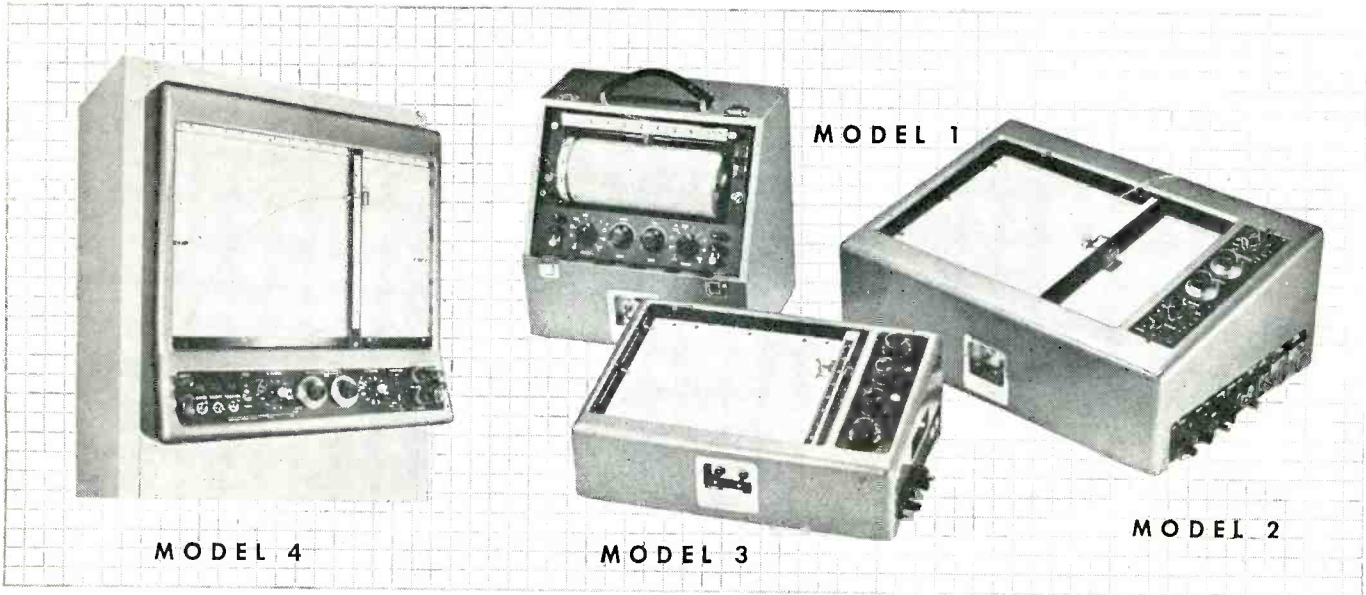

Now available in four versatile models, the Moseley AUTOGRAF X-Y recorder is a high quality, precision instrument providing economical means for plotting data quickly, easily, and accurately. It is widely used in research, development, and test laboratories where quantities of mechanical, physical and electrical data are being collected daily.

**MODEL 1**  
Drum Type  
8½"x11" paper  
X-Y Recorder-  
Curve Follower

**MODEL 2**  
Flat-bed  
11"x16½" paper  
X-Y Recorder-  
Curve Follower-  
Point Plotter

**MODEL 3**  
Desk Type  
8½"x11" paper  
X-Y Recorder-  
Curve Follower

**MODEL 4**  
Rack Type  
11"x16½" paper  
X-Y Recorder-  
Curve Follower-  
Point Plotter

## MOSELEY ACCESSORY PRODUCTS

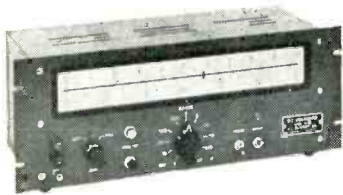

**MODEL 20 DC VOLTMETER**  
A servo-actuated, fast, accurate instrument with large, easy to read scale. Ranges from 3 millivolts to 300 volts.

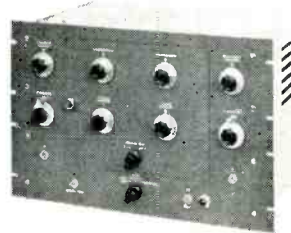

**MODEL 30 CARD TRANSLATOR** or  
**MODEL 50 TAPE TRANSLATOR**  
Converts information from punched cards or perforated tape for automatic plotting.



**MODEL 40 KEYBOARD**  
For plotting large amounts of tabular data in point-curve form. Self-contained voltage source with full three column keyboard in both axes.



**MODEL 60 LOGARITHMIC CONVERTER**  
For the plotting of gain-frequency runs in the 20-20,000 cps region. Couples audio circuit under test to Y axis of AUTOGRAF. 60 db dynamic range.

*We'll be glad to furnish additional information, write*

**F. L. MOSELEY CO.** | 409 N. Fair Oaks Ave.  
Pasadena, California

Represented in California, Arizona and New Mexico by

# G. S. MARSHALL CO.

"Marshall  
of the  
West"



## SALES REPRESENTATIVES IN THESE CITIES

### BOSTON

E. R. Vizard & Company  
215 Main Street  
Kingston, Mass. Kingston 2433

### BRIDGEPORT

E. R. Vizard & Company  
P. O. Box 51, Long Hill Branch  
Bridgeport 1, Conn. FOrest 8-2535

### CHICAGO

Gassner & Clark Company  
6644 North Western Avenue  
Chicago 45, Ill. ROgers Park 4-6121  
Teletype: CG 238

### CLEVELAND

Walter J. Brauer & Associates  
15631 Lakewood Heights Boulevard  
Cleveland 7, Ohio LAkewood 1-7268

### KANSAS CITY

Harris-Hanson Company  
7916 Paseo Avenue  
Kansas City 30, Mo. Hiland 6744

### MONTREAL

Aeromotive Engineering Products  
5257 Queen Mary Road  
Montreal 29, Quebec ELwood 9602

### NEW YORK

B. B. Taylor Company  
241 Sunrise Highway  
Rockville Centre, N. Y. ROckv. Cntr. 6-1014  
Teletype: Rockville Centre NY3685

### ST. LOUIS

Harris-Hanson Company  
2814 So. Brentwood Blvd.  
St. Louis 17, Mo. MIssion 7-4350  
Teletype: Web 237

### SAN FRANCISCO

G. S. Marshall Company  
2015 El Camino Road  
Redwood City, Calif. EMerson 6-8214

### SAN MARINO

G. S. Marshall Co.  
2065 East Huntington Drive RYan 1-9663  
San Marino, Calif. SYcamore 5-2022

### TORONTO

Aeromotive Engineering Products  
P. O. Box 760  
Brampton, Ontario BRampton 2343

### TUCSON

G. S. Marshall Co.  
3686 Baker Place  
Tucson, Ariz. EAst 7-1501

### PHILADELPHIA—WASHINGTON

William I. Duncan & Associates  
5452 Charles Street  
Phila. 24, Pa. CUmberland 9-7525

### SYRACUSE

I. A. Hotze  
Skyline Bldg.—753 James St.  
Syracuse 3, N. Y. SYracuse 9-7387



## REPORTS FROM THE STRATOSPHERE

with  
**Vitramon<sup>®</sup>**  
Capacitors

Almost from the first "whoosh," we groundlings must depend on instruments for guiding and reporting. Here, where only the best of electronic equipment is good enough, the leading manufacturers of guided missiles and fire-control systems specify "VITRAMON" capacitors — specify them because *only* "VITRAMON" capacitors are:

- STABLE
- RUGGED
- LOW LOSS
- LOW NOISE
- MINIATURE
- VAPORPROOF
- WIDE TEMPERATURE RANGE

NOW — A new design — the CY Series — adds two *additional* plus values:

- Unitized electrode/lead construction
- Complete insulation.

This new series, too, is available in values from 0.5 to 6800  $\mu\text{f}$ . Catalog 55-1 tells the whole story. It's yours for the asking.

*V<sup>®</sup>* and *Vitramon<sup>®</sup>*

are Registered Trade Marks  
of Vitramon, Inc.

CY22C  
500 VDC

# Vitramon

INCORPORATED

P.O. Box 544 E Bridgeport 1, Conn.

"Marshall  
of the  
West"



Represented in California, Arizona and New Mexico by

# G. S. MARSHALL CO.

## MUST YOUR EQUIPMENT BE RADIO INTERFERENCE FREE?

### IF YOURS IS A TOUGH RF INTERFERENCE PROBLEM— LET FILTRON SOLVE IT . . . .

FILTRON'S engineering department, cooperating with engineers of leading companies, has solved RF Interference Suppression problems throughout the country.

If your equipment must meet the RF Interference limits set by the military specifications, consult with FILTRON'S engineers in the earliest stages of design. FILTRON can furnish RF Interference Suppression Filters whose size, weight and overall configuration will fit into your equipment.

FILTRON has custom designed over 1000 different types of RF Interference Suppression Filters for equipment that meets military RF Interference Suppression limits and specifications.

FILTRON'S completely equipped screen rooms are always available for the RF Interference testing of your units and equipment.

An inquiry on your company letterhead will receive prompt attention.

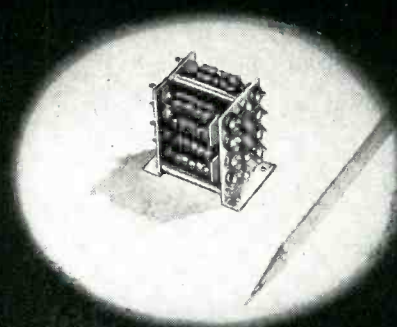

8 circuit miniaturized filter for wide band RF Interference Suppression.

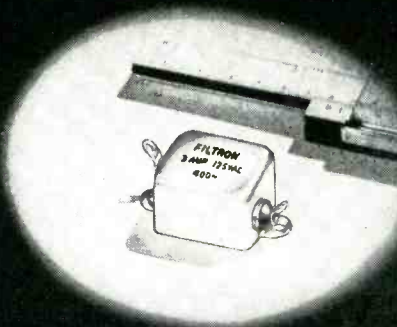

Miniature 3 amp. - 125 VAC - 400~ filter - hermetically sealed - size 1 1/8" x 1" x 1 1/16"

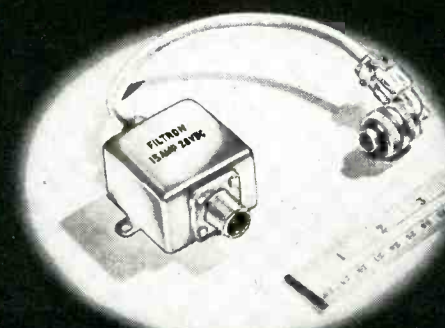

15 amp. - 28 VDC filter, size 2" x 2" x 1 1/4", with pressurized AN connectors - high attenuation from 150 KC to 400 MC.

#### FILTRON can best solve your RF Interference problems because:

- FILTRON'S engineering, research and design divisions are staffed by experienced RF Interference Suppression filter engineers.
- FILTRON'S modern shielded laboratories are equipped to measure RF Interference from 14 KC to 1000 MC in accordance with military specifications.
- FILTRON'S production facilities, comprising a capacitor manufacturing division, coil winding division, metal fabrication shop, metal stamping and tool and die shops, are exclusively producing the highest quality components for FILTRON'S RF Interference Suppression Filters.
- FILTRON'S extensive production facilities permit us to meet your delivery requirements. NOW!

#### RF INTERFERENCE SUPPRESSION FILTERS FOR:

Motors	Dynomotors
Generators	Power Plants
Inverters	Actuators
Electronic Controls	Gasoline Engines

And other RF Interference producing equipment

*filtered by* **FILTRON**



LOCKHEED XF-90



Send for your copy of our NEW CATALOG on your company letterhead.

# FILTRON CO., INC.

FLUSHING, LONG ISLAND, NEW YORK  
PLANTS IN FLUSHING, NEW YORK, AND LOS ANGELES, CALIFORNIA

Canadian Representative: Aircraft Appliances & Equipment Ltd., 585 Dixon Side Road, Toronto 15, Ont., Canada



Represented in California, Arizona and New Mexico by

# G. S. MARSHALL CO.

"Marshall  
of the  
West"



## PACKAGED FREQUENCY MANAGEMENT

### JK SULZER FREQUENCY STANDARD

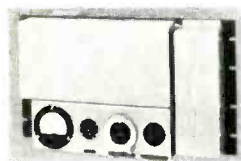

**JK Sulzer Frequency Standard:** For your most precise laboratory measurements, the JK SULZER 1 megacycle Frequency Standard provides stability of better than 1 part in  $10^9$  per day. Frequency is variable over a range of 0.9 cycles or more, and capable of being reset to 5 parts in  $10^{10}$ .

### JK THERMYSTAL

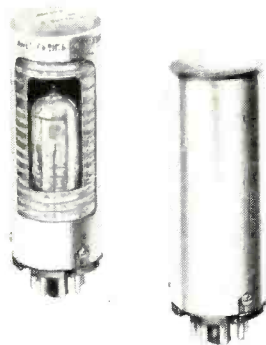

**JK Thermystal:** An advanced-design frequency control unit combining plug-in simplicity with extreme precision. *Frequency stability:* 30 to 900 kc,  $\pm .0001\%$ ; 1000 kc to 150 mc,  $\pm .00005\%$ .

### JK TRANSISTOR OSCILLATOR

**JK Transistor Oscillator:** Complete, compact, precise plug-in signal source providing fixed temperature and humidity environment for transistor and circuitry elements. *Frequency stability:* (24-hr. period) 1 part in  $10^6$ .

### JK CRYSTAL FILTERS



**JK Crystal Filters:** Compact, rugged, hermetically-sealed and stable, JK CRYSTAL FILTERS (band pass filters) have a *Frequency Range:* 1 mc to 17.5 mc., and are available for special filtering purposes to 150 mc. *Band Width* at 6 db: 0.01% to 4% of nominal on all frequencies, and up to 12% for certain frequencies.

### JK GLASLINE CRYSTALS

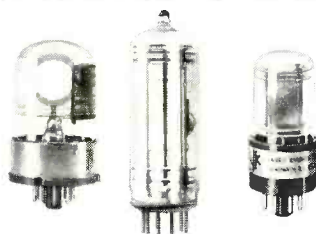

**JK Glasline Crystals:** For ultra stable frequency control, JK GLASLINE CRYSTALS provide unprecedented stability and reliability. Compact, evacuated and hermetically-sealed against moisture, contamination, shock, and barometric pressure. Over a complete range of 800 cycles to 5 mc. and up.

### JK MILITARY TYPES

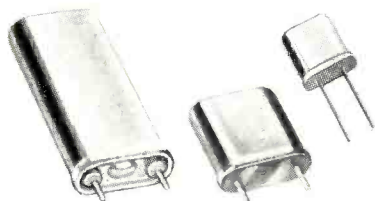

**JK Military Types:** Hermetically-sealed, JK MILITARY TYPE CRYSTALS are metal-cased and in *Frequency Ranges:* 16 kc to 100 mc.

### JK OVENS

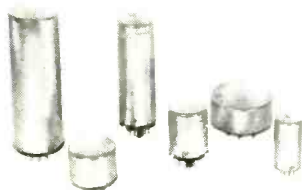

**JK Ovens:** Capable of maintaining set temperatures around components or circuitry with less than  $\pm 1^\circ$  C. variation over the range of  $-55^\circ$  to  $+100^\circ$  C., JK OVENS are light, compact, inexpensive, uniform and reliable.

"Marshall  
of the  
West"



Represented in California, Arizona and New Mexico by

**G. S. MARSHALL CO.**

**I E R C . . . . .** electron tube shields

**IMPROVE  
MISSILE  
RELIABILITY**

**... help them get  
where they're going!**



Patents Pending — Cross-licensed  
with North American Aviation, Inc.

**I E R C** offers the only shields commercially available that will meet or exceed MIL-S-9372 for temperature resistance, vibration control, compatibility with all tube diameter tolerances and have approval as Heat-dissipation shields for providing lowest bulb operating temperatures through proper design and function.

Improve your equipment reliability—specify IERC "B" type shields to end premature tube failures caused by heat and vibration effects.



**I E R C** SUBMINIATURE TUBE CLAMPING SHIELDS are the most widely preferred maximum-cooling miniature shields in use on all sizes and types of subminiature tubes. Special-purpose types can be developed for your individual requirements. Write for Technical Bulletin 1203-556 showing present models for plate, bracket, channel, top and right angle mounting.

**International**



**electronic research corporation**

145 West Magnolia Boulevard, Burbank, Calif.

Informative IERC Technical Bulletins can help you end electron tube failures caused by heat and vibration — write for your copies today!

Represented in California, Arizona and New Mexico by

**G. S. MARSHALL CO.**

"Marshall  
of the  
West"



# New RCA Line of Precision Instruments for Measurement and Control Accuracy

**BACKED BY THE RCA REPUTATION FOR ENGINEERING EXCELLENCE**

## SIGNAL GENERATOR

TYPE LG-20  
(42 KC to  
50 MC)

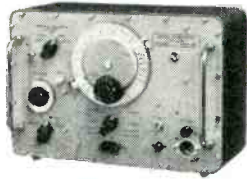

### APPLICATIONS:

Design or production test and alignment functions in IF, police, marine and amateur bands.

### FEATURES:

- Negligible RF leakage
- IF spread band 420-500 KC
- High output for RF bridge excitation
- Portable
- Output from 1  $\mu$ v to 1 volt
- Excellent stability

VHF Signal Generators also available

## STANDARD SIGNAL GENERATOR

TYPE LG-21  
(50 KC to  
50 MC)



### APPLICATIONS:

Circuit development and alignment; signal source for sensitivity, selectivity and resonance curves.

### FEATURES:

- Negligible RF leakage
- Choice of Modulated RF, CW, or audio through output attenuator
- Variable metered output
- Internal or external modulation
- Multi-vibrator for making tracking measurements
- Adjustable modulation depth

VHF Signal Generators also available

## IMPEDANCE BRIDGE

TYPE LB-50



### APPLICATIONS:

Rapid, accurate, direct, and comparison measurements of resistance, capacitance, inductance and dissipation factor.

### FEATURES:

- Comparison Bridge reads directly in percentage difference
- "Magic Eye" indicator
- Simple to operate
- Portable

Precision Impedance Bridges also available

## MULTIMETER

TYPE LM-1



### APPLICATIONS:

Accurate measurement of resistance, AC and DC voltage and current.

### FEATURES:

- Instantaneous overload protection
- High sensitivity—20,000 ohms per volt, AC and DC
- One range-selector switch
- Accurate, rugged meter movement
- Batteries replaceable without opening case
- Easy vision case design

## DC NULL VOLTMETER

TYPE LV-15  
(0 to 100 V)



### APPLICATIONS:

Fast, accurate voltage measurements related to transistors, thermocouples, strain gauges, power supplies, accelerometers, resistive pressure gauges, displacement transducers, humidity indicators, DC amplifier, photocells, pH meters, bolometers, position indicators, batteries.

### FEATURES:

- Excellent accuracy
- High resolution
- Negligible loading
- High sensitivity
- Wide range
- Internal calibration
- Portable

Also a DC Null Voltmeter Type LV-14 (0 to 600 V)

## VACUUM TUBE VOLTMETER

TYPE LV-10



### APPLICATIONS:

Precise measurement of: AC or DC voltages and resistance; audio, video and UHF circuit characteristics; general high impedance circuits.

### FEATURES:

- Excellent stability
- Specially balanced and rugged meter movement
- Measurements to 700 MC
- High input impedance
- AC measurements to 1,500 V.
- DC measurements to 30,000 V.
- Resistance measurements to 1,000 megohms
- Storage space for cables

## RF POWER METERS

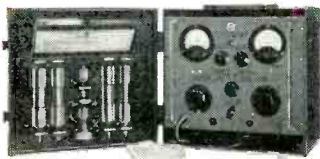

TYPE LP-90 (20 MC to 1,000 MC)  
TYPE LP-91 (1,000 MC to 10,000 MC)

### APPLICATIONS:

Television • Radar • Navigation • Transmission lines • Antennas • Production testing • Microwave links • Communications • Signal generators • Telemetering

### FEATURES:

- Complete, ready to operate
- Direct reading
- Portable, compact
- Rugged components
- Reliable operation

## MECHANICAL FILTER

250 KC upper and lower sideband  
TYPE MFU-250-1  
TYPE MFL-250-1



### APPLICATIONS:

#### For use in

- Highly selective IF stages of single sideband communication receivers and modulation circuits for single sideband transmitters.
- Upper (Type MFU-250-1) and lower (Type MFL-250-1) sideband mechanical filters at this frequency are available.

### FEATURES:

- Extremely low insertion loss
- Highly stable over wide temperature range
- Special shock resistant construction
- Excellent selectivity

*Designed to the exacting standards of RCA precision electronic equipment, these instruments will facilitate the design, development and testing of radar, computers, fire control systems, radio and television receivers, communications and sound equipment. For additional information, ask for RCA's new Precision Instruments brochure. Write Department KM-46, Building 15-1, Camden, N.J.*



**RADIO CORPORATION of AMERICA**

COMMERCIAL ELECTRONIC PRODUCTS

CAMDEN, N. J.

"Marshall  
of the  
West"



Represented in California, Arizona and New Mexico by

**G. S. MARSHALL CO.**

**NOW!** **FOR THE FIRST TIME**  
DIRECT WRITING CONVENIENCE  
WITH PHOTOGRAPHIC ADVANTAGES!

**Introducing** *Century* **ELECTROGRAPH MODEL 420**



**ELECTROPHOTOGRAPHIC  
RECORDING  
OSCILLOGRAPH**

*You Asked For This!*

**ONLY THE REVOLUTIONARY CENTURY ELECTROGRAPH OFFERS THESE FEATURES**

- Permanent instantaneous oscillograms
- Eliminates need for messy liquid chemicals
- No darkroom required
- Automatic continuous dry processing
- View oscillogram while recording
- Utilizes sensitive light-beam galvanometers
- Up to 24 traces on eight inch paper
- Traces can overlap
- Precision timing lines
- Low power consumption

Century's engineers are the first to accomplish the long dreamed-for wedding of photographic recording and completely automatic dry processing to eliminate the need for costly darkroom facilities and liquid developing, rinsing and fixing.

The greatest advancement in the technique of multi-channel oscillograph recording in over 20 years, the CENTURY ELECTROGRAPH is essentially a direct-writing recording oscillograph utilizing the

RADICALLY new technique of Electrophotography combined with light-beam galvanometers.

NOW investigate CENTURY ELECTROGRAPH—the most modern approach to simplified oscillographic recording — when planning your instrumentation program whether for research, engineering, test, quality control, process control, or any other analog recording requirement.

**COSTS NO MORE THAN OLD-FASHIONED METHODS**



**Century Electronics & Instruments, Inc.**

1333 NO. UTICA, TULSA, OKLAHOMA

For further information, call on our nearest representative:  
EXPORT OFFICE: 149 BROADWAY, NEW YORK CITY — TEL.: BARCLAY 7-0562

PHILA.-WASH. AREA  
4447 N. BODINE ST.  
PHILADELPHIA 40, PA.  
TEL. MICHIGAN 4-1822

N.Y.-NEW ENGLAND AREA  
29-46 NORTHERN BLVD.  
LONG ISLAND CITY 1, N. Y.  
TEL. STILLWELL 4-3120

MIDWEST AREA  
363 W. FIRST ST.  
DAYTON 2, OHIO  
TEL. EHLTON 2000

TEXAS-N. M. AREA  
5526 DYER ST.  
DALLAS, TEXAS  
TEL. EMERSON 2700

ARIZONA AREA  
3686 BAKER PL.  
TUCSON, ARIZONA  
TEL. 2-1100

SO. CALIF. AREA  
40 SO. LOS ROBLES  
PASADENA 1, CAL.  
TEL. 792-1100

NO. CALIFORNIA  
2015 EL CAMINO REAL  
REDWOOD CITY  
TEL. 352-1100

# MICRO precision switches



... THEIR USE IS A PRINCIPLE OF GOOD DESIGN

there is always  
 "SOMETHING NEW"  
 at MICRO SWITCH  
 for product designers

Experienced designers know both time and money are saved when they check with MICRO SWITCH on their complex switching problems. If we have not already solved their problem, MICRO SWITCH engineering is experienced in cooperating with product designers to quickly develop a precision switch to meet the requirements.

Here are four such new switches, each developed to meet a specific need, each capable of many variations of actuation, circuitry and housings.

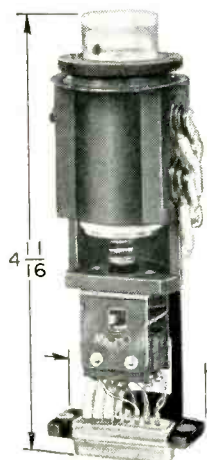

3-LIGHT  
 PUSHBUTTON  
 SWITCH  
 FOR COMPLEX  
 CONTROL PANELS

"PB" Series 3-light  
 pushbutton actuated switch

Here is a new, unique indicating pushbutton switch which lights in three different colors. This compact assembly is the result of an original requirement for

a "super-reliable" long-life pushbutton switch for use in computer consoles for guided missiles control systems.

Designed for use in applications where *absolute dependability* is required, this switch is manufactured under extremely careful quality control procedures. The result is a reliable life through hundreds of thousands of operations.

A special, exclusive feature is the incorporation of a "radio tube" type connector, or plug-in base, which carries all the connections to the basic switches and lamp terminals. The entire assembly is easily pulled out for lamp replacement. (Send for Data Sheet 110)

MICRO SWITCH Engineering is at your service from convenient branch offices in key cities everywhere. It is as close as your telephone. Consultation costs you nothing. Can save you time and money.

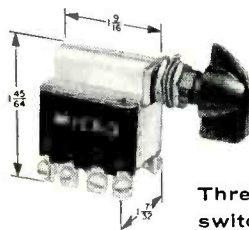

THIS TOGGLE  
 SWITCH HAS LONG  
 LIFE AND BETTER  
 DETENT "FEEL"

Three-position rotary type toggle switch. "TR" Series

Here is a new solution to the problem of mechanical actuation of many circuits with a single manual motion. This new series of "TR" switches offers all the advantages of a toggle switch mechanism plus *longer operating life and better detent "feel."*

These switches provide a high electrical capacity in a very small space, permitting the elimination of relays and other electrical devices in many circuits.

They are rugged enough for most airborne and industrial applications and have successfully passed rigid tests for impact, shock, acceleration and vibration.

The "TR" switch shown is a four-pole double-throw switch with 12 terminals. It is maintained in all three actuation positions: on-off-on. Other "TR" switches are available with up to 24 terminals (8 poles). (Send for Data Sheet 112)

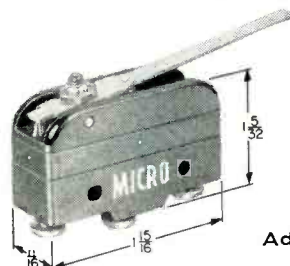

PRECISE,  
 UNERRING ACTUATION  
 THROUGH MILLIONS  
 OF OPERATIONS

Adjustable lever actuated switch

An adjustable lever actuator on this switch permits close adjustment of the operating point without removing the switch from its mounting.

This switch is designed for use on such equipment as timers, computers or other multiple-mounted switch devices which require *precise, unerring actuation* through millions of operations.

The operating position is adjustable through .210 inch. The switches are available with a wide selection of pre-set operating characteristics. They are also available with split-contact double-throw circuitry. (Send for Data Sheet 100)



THIS SWITCH GIVES  
 PRECISE PERFORMANCE  
 UNDER MOST  
 EXTREME CONDITIONS

The MICRO "EN" Switch is completely sealed, cylindrical in shape. Tests have shown its precise performance to be unaffected by ice-coating at -65°F or by heat to +180°F. A thousand hours in salt brine spray or 30 days operation at 104°F (95% humidity) still finds

it going strong—and precisely. No chattering of contacts, no loosening of parts occurs during vibration tests of 10 to 500 cycles per second.

Contact arrangement is double-pole, double-throw. Weight (without leads) 2½ oz.

(Send for Data Sheet No. 105)

# MICRO SWITCH

A DIVISION OF MINNEAPOLIS-HONEYWELL REGULATOR COMPANY

In Canada, Leaside, Toronto 17, Ontario • FREEPORT, ILLINOIS



# New Grant 3400

*thinslide*

*mounts standard 17" chassis  
in standard 18" rack or cabinets*

**REQUIRES ONLY 19/64" SPACE PER SIDE—**

**YET HAS**

**FULL ROLLER ACTION**

*(fits RETMA rack hole spacing)*

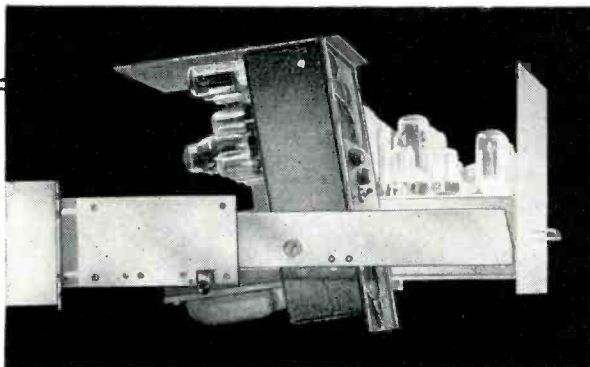

The Grant 3400 Thinslide requires only 19/64" space per side—installs readily in standard racks and cabinets. Allows instant access to chassis measuring from 10" to 16" deep. Tilts through 100° for under-chassis servicing. Positive lock in "out" position. Lock has finger-tip release for instant return or removal of chassis. Eight hardened steel rollers carry the rated load of 100 lbs. smoothly and easily—durability insures frictionless rolling for thousands of cycles of use.

Slide mounting not only provides for quick access—it usually eliminates need for rear access doors and rear aisles—a very important saving of space.

The Grant 3400 is a versatile slide, suited for use in your *product*, in *plant equipment*, *prototype* and *breadboard* work, and in *production line* or *field test equipment*. Very moderate cost allows a wide range of applications in original equipment.

Write today for Grant 3400  
Thinslide Technical Bulletin—contains  
full data and specifications.

**Grant** INDUSTRIAL SLIDES

Grant Pulley and Hardware Corporation  
factories: 31-73 Whitestone Parkway, Flushing 54, N. Y.  
944 Long Beach Avenue, Los Angeles 21, Calif.

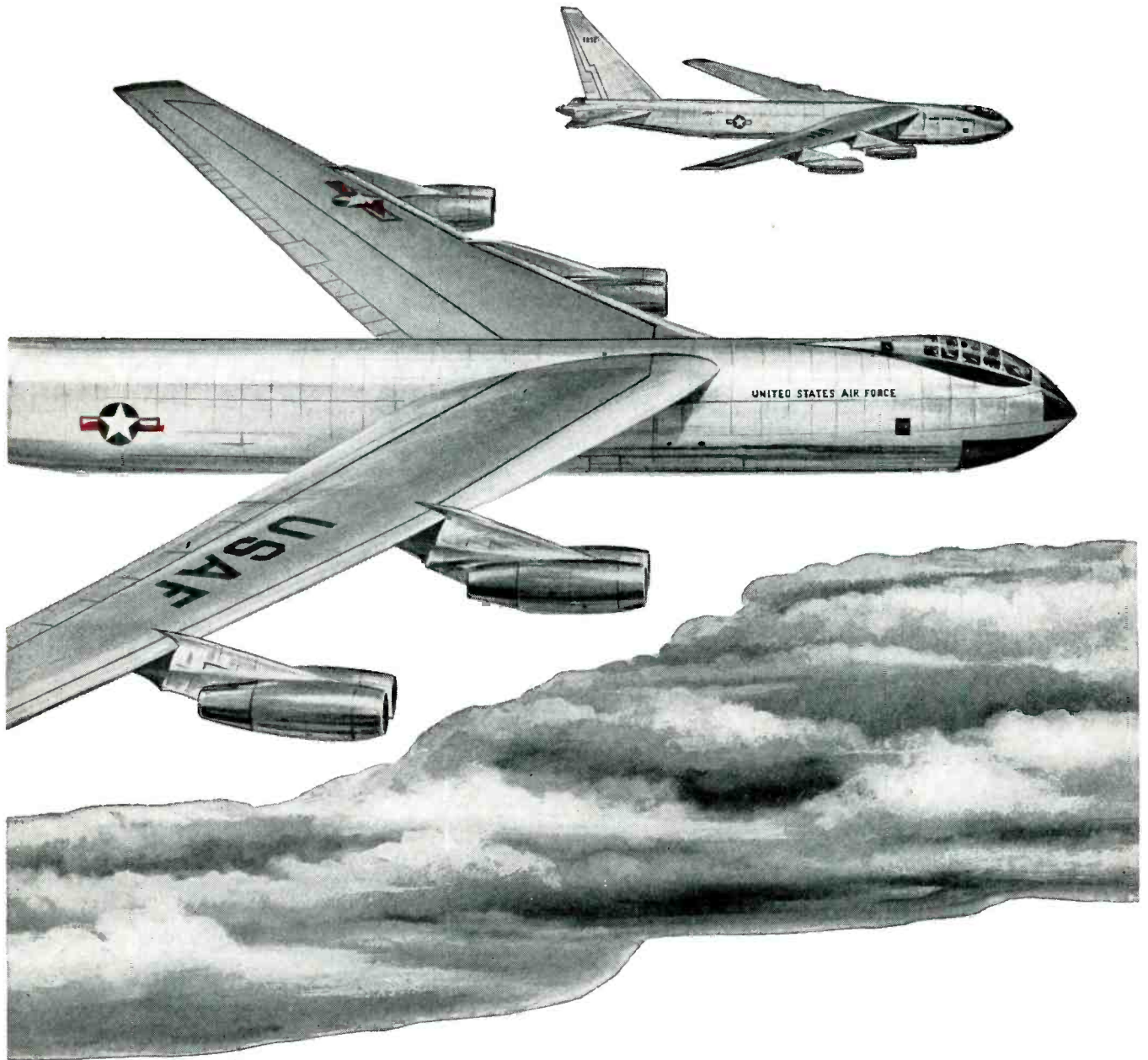

## **RAYTHEON RADAR FOR THE B-52**

Finding and smashing a bombing target through thick overcast when you are miles high, traveling at fantastic speeds, is no easy proposition.

To help solve this complex problem, the Air Force worked with Raytheon—a leader in both CW and pulse radar techniques and world's largest manufacturer of the magnetron and klystron tubes essential to radar.

Result? A precision radar of uncanny accuracy and outstanding reliability—a bombing radar which adds to the punch of this remarkable aircraft conceived by the foresight of the United States Air Force.

*Excellence in Electronics*



**RAYTHEON MANUFACTURING COMPANY**  
WALTHAM 54, MASSACHUSETTS

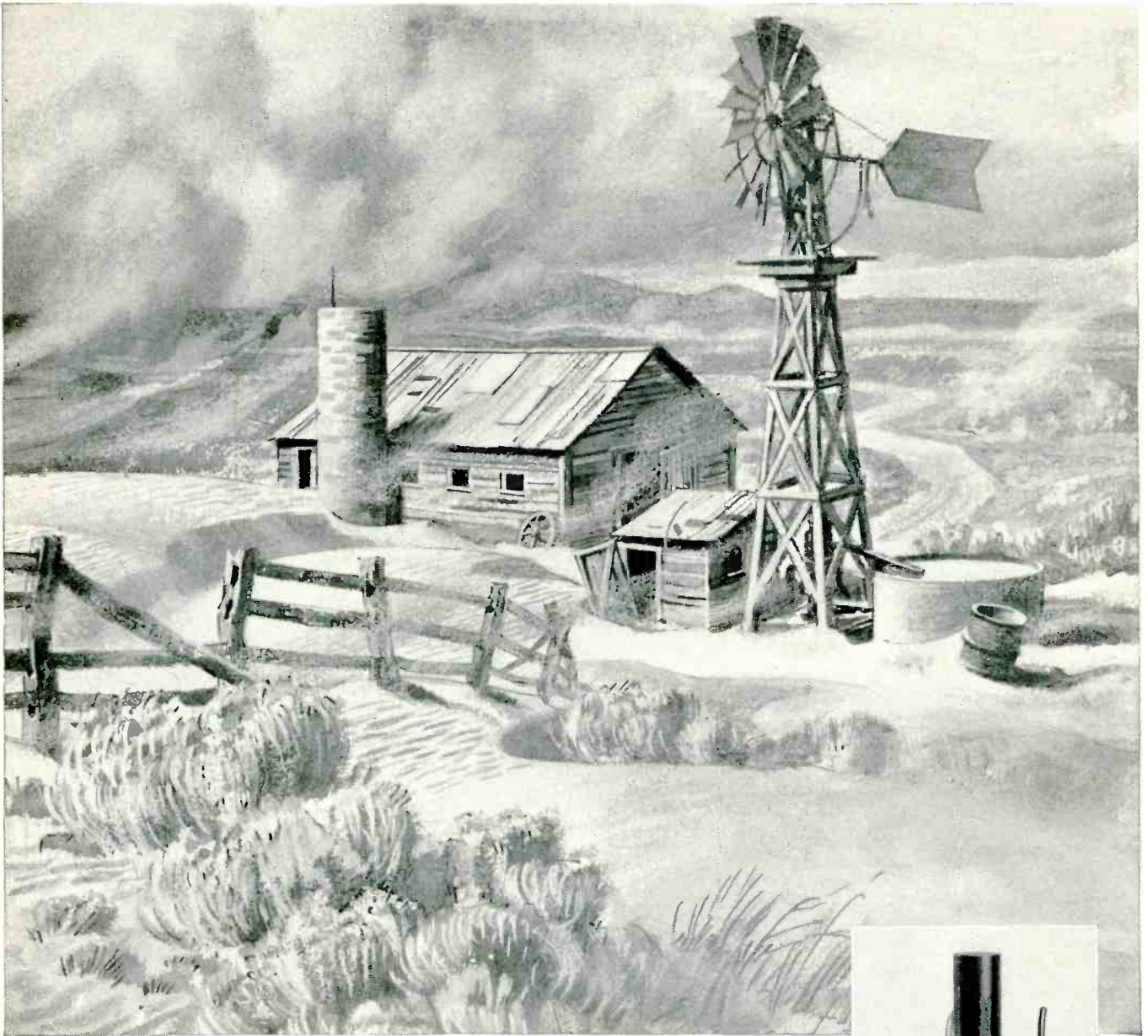

If you have a dust and dirt problem,  
it'll pay you to use

# Adlake mercury relays

Adlake relays require no maintenance whatever...are quiet and chatterless...free from explosion hazard. Dust, dirt, moisture and temperature changes can't affect their operation. Mercury-to-mercury contact gives ideal snap action, with no burning, pitting or sticking. Time delay characteristics are fixed and non-adjustable.

For more information about Adlake Relays, write The Adams & Westlake Company, 1171 N. Michigan, Elkhart, Indiana

**The Adams & Westlake Company**

the original and largest manufacturers of mercury plunger-type relays  
Established 1857 • ELKHART, INDIANA • New York • Chicago

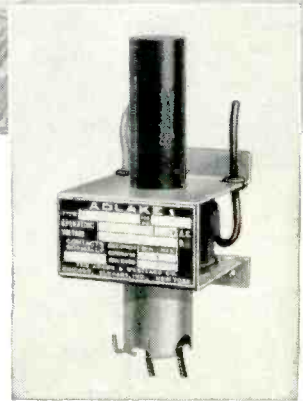



# ruggedization

-that goes  
**BEYOND**  
today's  
frontiers!

**E-I** COMPRESSION  
TYPE  
**PLUG-IN  
CONNECTORS**

### Octal Plug-in Connectors

Keyed and gaged for use with RETMA octal type sockets. Terminations supplied to meet practically any requirement.



### Vibrator and Special Connectors

Designed for vibrator, chopper and lock-in sockets. Except for lock-in types, orientation by pin arrangement eliminates locating key need.



### Noval Plug-ins

Gaged for precise fit in standard type noval sockets.



### Miniature types

Same super-rugged construction as large connectors.



Exclusive E-I compression construction provides super-rugged seals that withstand the most grueling operating environments

These time-proven E-I seals have demonstrated their ability to withstand the most severe environments encountered in today's critical applications. Highly resistant to shock and vibration, E-I compression plug-in connectors provide maximum immunity to humidity and wide temperature fluctuations. In thousands of commercial and military components, rugged E-I compression seals have been proven to possess electrical and mechanical characteristics that exceed requirements.

Your nearest E-I field engineer will gladly supply complete information on —

- SPECIAL APPLICATION and CUSTOM SEALS
- CRYSTAL and SUB-MINIATURE CLOSURES
- DIODE and TRANSISTOR CLOSURES
- MULTI-LEAD HEADERS
- SINGLE LEAD TERMINALS • END SEALS

\*Patent pending — all rights reserved



**ELECTRICAL INDUSTRIES**

44 SUMMER AVE., NEWARK 4, NEW JERSEY



# NEW

**Model R**

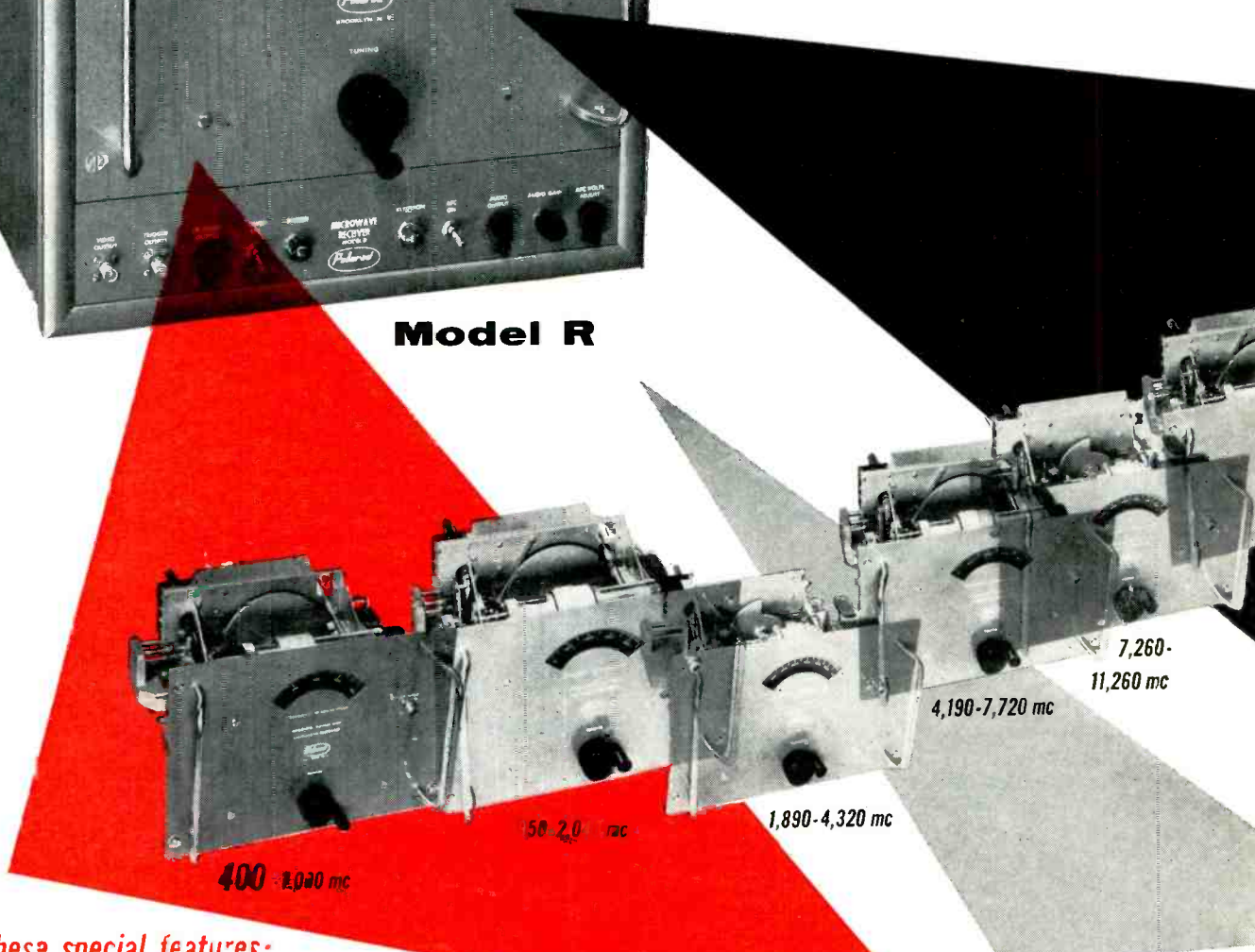

**Note these special features:**

- AM, FM, CW, MCW, and PULSE reception.
- Uni-dial control.
- Direct reading.
- Broadband coverage.
- Output level reading directly in db.
- High sensitivity.
- Seven interchangeable plug-in r-f tuning units cover the entire frequency range.
- Low noise figure; excellent gain stability.
- Microwave preselection, tracked and double-tuned, used in the plug-in tuning units covering the range 400 to 11,260 mc.
- Audio, video, and trigger outputs.
- Special recorder output.
- High video output—low impedance.
- AGC and AFC circuits.

**For these applications:**

- General communications.
- Field intensity meter.
- Frequency meter.
- Measurement of radiation and leakage of microwave devices.
- Measurement of bandwidth of microwave cavities.
- Measurement of relative power of fundamental and harmonic signal frequencies.
- Measurement of noise figure.
- Antenna field patterns.

# EXTENDED RANGE MICROWAVE RECEIVER!

## 400 to 22,000 mc



### SPECIFICATIONS:

#### Basic Receiver: Model R-B

#### Tuning Unit Frequency Ranges:

Model RR-T	400 — 1,000 mc
Model RL-T	950 — 2,040 mc
Model RS-T	1,890 — 4,320 mc
Model RM-T	4,190 — 7,720 mc
Model RX-T	7,260 — 11,260 mc
Model RKS-T	9,500 — 15,600 mc
Model RKU-T	14,700 — 22,000 mc

#### Signal Capabilities:

AM, FM, CW, MCW, pulse

#### Sensitivity:

- (a) For Model RR-T: Minus 85 dbm
- (b) For Models RL-T, RS-T, RM-T, and RX-T: Minus 80 dbm
- (c) For Models RKS-T and RKU-T: Minus 65 dbm

#### Frequency Accuracy: $\pm 1\%$

IF Bandwidth: 3 mc

Video Bandwidth: 2 mc

#### Image Rejection:

- (a) For Models RR-T thru RX-T: Greater than 60 db

- (b) For Models RKS-T and RKU-T: Spurious response rejection obtained through the use of a bandpass filter

Gain Stability with AFC:  $\pm 2$  db

#### Automatic Frequency Control:

Pull-out range 10 mc off center

Recorder Output: 1 ma. full scale (1,500 ohms)

#### Trigger Output:

Positive 10-volt pulse across 100 ohms

#### Audio Output:

5 volts undistorted, across 500 ohms

#### FM Discriminator:

Deviation Sensitivity: .7 v./mc

#### Skirt Selectivity:

60 db — 6 db bandwidth ratio less than 5:1

#### IF Rejection: 60 db

#### Input AC Power:

115, 230 V ac, 60 cps, 440 watts

#### Input Impedance:

Models RR-T through RX-T: 50 ohms  
Models RKS-T & RKU-T: waveguide

Three new r-f tuning units double the frequency range of the well-known Polarad Microwave Receiver. Now more than ever the Model R becomes a basic multi-purpose instrument for microwave research and production in the field, in the laboratory, and in the factory.

This receiver is designed for quantitative analysis of microwave signals and is ideal for the reception and monitoring of all types of radio and radar communications within the broadband 400 to 22,000 mc. It permits comparative power and frequency measurements, by means of its panel-mounted meter, of virtually every type of signal encountered in microwave work.

It is compact and functional, featuring 7 integrally designed plug-in, interchangeable RF microwave tuning units to cover 400 to 22,000 mc; non-contacting chokes in pre-selector and microwave oscillator to assure long life and reliability; and large scale indicating meter for fine tuning control.

Call any Polarad representative or direct to the factory for detailed specifications.

VSWR: Less than 4:1 over the band

Range of Linearity: 60 db

Receiver Type: Superheterodyne

#### Maximum Acceptable Input

Signal Amplitude: 0.1 volt rms, without external attenuation

Video Response: 30 cps to 2 mc

Size: 17" w x 23" d x 19" h

Weight: 180 lbs. for basic unit with one tuning unit.

#### Price:

Model R-B (basic unit)	\$1,500
Model RR-T	2,500
Model RL-T	2,500
Model RS-T	2,500
Model RM-T	2,500
Model RX-T	2,500
Model RKS-T	2,500
Model RKU-T	2,500

Note: To the basic cost of \$1,500 add cost of tuning units required.

Prices subject to change without notice

AVAILABLE ON EQUIPMENT LEASE PLAN



## ELECTRONICS CORPORATION

43-20 34th Street • Long Island City 1, New York

**Immediate  
maintenance  
available by field  
service specialists**

REPRESENTATIVES: Albuquerque, Atlanta, Baltimore, Boston, Buffalo, Chicago, Cleveland, Dayton, Denver, Fort Worth, Kansas City, Los Angeles, New York, Philadelphia, Portland, St. Louis, San Francisco, Schenectady, Syracuse, Washington, D. C., Winston-Salem, Canada; Arnprior, Ontario. Resident Representatives in Principal Foreign Cities

**all new**



**precision**

**18  
KMC**

The revolutionary new waveguide equipment shown here represents a practical, efficient adaptation of an ultra-modern concept of waveguide instrumentation. Emphasis throughout is on functional simplicity, rugged dependability, highest accuracy, and low cost. The instruments are offered as individual basic test components, yet all are integrated electronically and mechanically with the *-hp-* waveguide line.

There has been no compromise with traditional *-hp-* quality in extending *-hp-* waveguide instrument coverage to the 40 KMC region. Yet there is present the same ingenious design simplicity which make possible mass-production economy—low cost to you.

Today, more than ever, *-hp-* offers you the best value in waveguide instrumentation ever available.

**HEWLETT-PACKARD COMPANY**

3809A Page Mill Road • Palo Alto, Calif., U.S.A.

Cable "HEWPACK" • Davenport 5-4451

Field engineers in all principal areas

**each covers full waveguide band  
accurate, stable, versatile  
*-hp-* quality at low cost  
easy set-up, simple operation**



◀ **-hp- 375A Variable Flap Attenuators.** For introducing variable power levels, or isolating power sources and loads. Consists of a single slotted section with movable matched resistive strip. SWR less than 1.15. *-hp-* K375A, \$60.00. *-hp-* R375A, \$70.00.

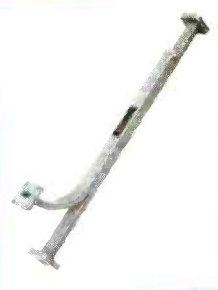
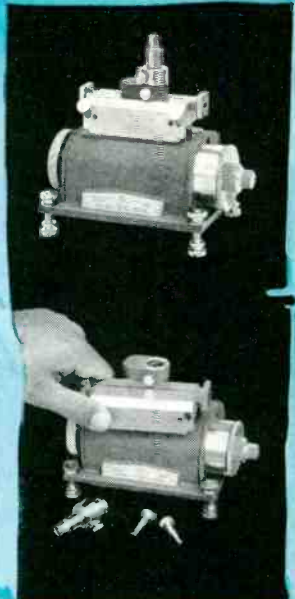

◀ **-hp- 752 Directional Couplers.** Available with coupling factors of 3, 10 and 20 db  $\pm$  0.7 db full range. SWR better than 1.05. Directivity 40 db or better over entire range. *-hp-* K752, \$100.00. *-hp-* R752, \$120.00.



◀ **-hp- 910A Waveguide Terminations.** Matched load for use where waveguide must be terminated in its characteristic impedance. Residual reflection approx. 1.0%. Average power 0.5 watts. *-hp-* K910A, \$30.00. *-hp-* R910A, \$35.00.



**See your  representative for quality**

to  
**40**  
KMC

**complete  
coverage**

### **K-band**

18 to 26.5 KMC  
.500" to .250"

### **R-band**

26.5 to 40.0 KMC  
.360" to .220"

#### ◀ **-hp- 814A UNIVERSAL PROBE CARRIAGE**

Covering frequencies 12.4 to 40.0 KMC, the new, convenient -hp- 814A mounts -hp- 815A Waveguide Slotted Sections in P, K and R bands. Waveguides may be interchanged instantly with positive-accuracy alignment. For use with the new -hp- 446A Broadband Probe (\$145.00), the 814A Carriage provides direct readings to 0.1 mm and interpolation to 0.01 mm (approximately 0.001 wavelength). Dial adjusts quickly for differential readings; accuracy is assured by a precision-threaded drive free of backlash. SWR to 1.02 is easily read, and slope error can be eliminated. \$225.00.



◀ **-hp- 815A Slotted Sections.** Extremely careful machining insures time-saving accuracy for measuring SWR to determine reflection, match and impedance. Machined from tellurium copper; exterior rhodium plated to prevent corrosion. -hp- P815A, K815A, or R815A, \$200.00.

◀ **-hp- 487A Thermistor Mounts.** Broadband mounts for fast, accurate power measurements. Negative-temperature coefficient thermistors provide burnout protection. SWR approx. 2.0. -hp- K487A, \$85.00.



◀ **-hp- 870A Slide Screw Tuners.** For flattening waveguide systems. Probe sets up SWR which cancels existing SWR. No backlash in adjustments. Accuracy SWR 1.02. -hp- K870A, \$140.00. -hp- R870A, \$140.00.



◀ **-hp- 880A E-H Tuners.** For tuning high power systems or setups where low leakage is essential. Consists of hybrid tee, with movable choke shorts in shunt and series arm. -hp- K880A, \$155.00. -hp- R880A, \$170.00.

◀ **-hp- 914A Moving Loads.** Low reflectance load (1.0%). Load position variable at least  $\frac{3}{4}$  wavelength, permitting reversing phase of residual reflection. -hp- K914A, \$65.00. -hp- R914A, \$75.00.



◀ **-hp- 920A Adjustable Shorts.** Croke type adjustable shorts for introducing reactance in combination with detecting sections, series, shunt or hybrid tees. -hp- K920A, \$75.00. -hp- R920A, \$85.00.

### **Remember**

-hp- also offers complete waveguide instrumentation 3 through 18 KMC for S, G, J, H, X and P bands!

**waveguide instrumentation 3 through 40 KMC!**

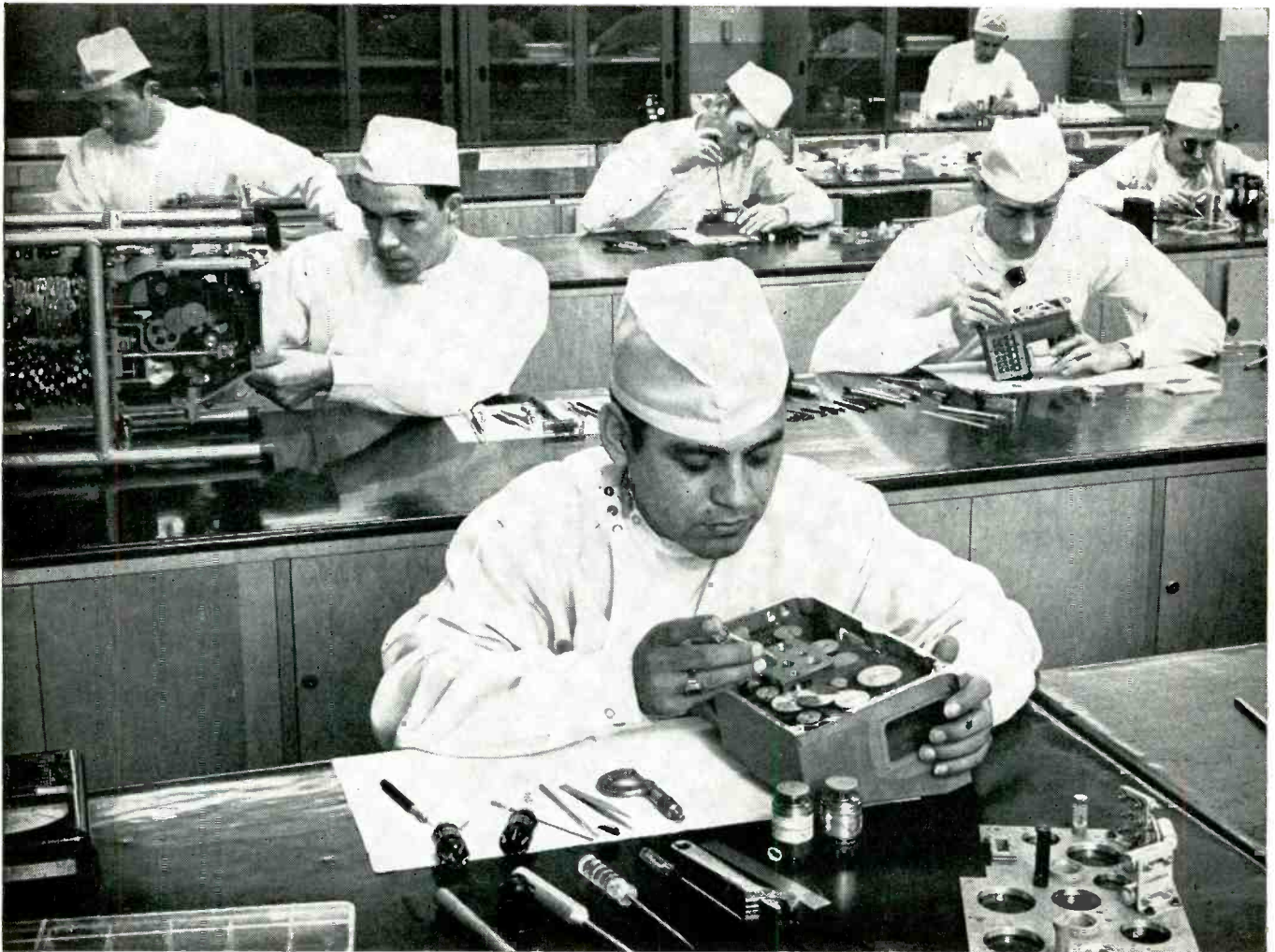

## *Operating room conditions for Inertial Instrument Development Engineering*

The work in this 5000 square-foot room at AUTONETICS is surgical in its precision, clinical in its standards of cleanliness. Here are assembled the precise mechanisms devised by the engineers and physicists engaged in the new field of INERTIAL NAVIGATION SYSTEMS. Among the units are highly-specialized types of Gyros and Accelerometers as delicate as a living organism.

Each cubic inch of air in this room contains fewer than 6 dust particles whose diameter exceeds 0.3 micron. Temperature variation is held to plus or minus 1°; humidity to less than 50%. AUTONETICS provides these ideal conditions, comparable with the standards attained in primary laboratory instrument work, to insure optimum results in the function of the tiny components, so painstakingly designed. The men who create them are reaching the highest levels of professional skill, as they obtain definitive answers to the problems of miniaturization and reliability under environmental extremes.

This facility is soon to be doubled. The hitherto unpublicized program is already ahead of the rest of the field. Prime need of the current expansion is for

See us at booths 626 and 627 at the  
Instruments and Automation Conference and Exhibit,  
New York, September 17-21.

men who can make a *creative* contribution.

**You Can Participate In This Work. Act Now:**

Here are the fields in which your individual contribution can bring you distinction in your profession :

**Mechanical Engineering:** Analysis, Development, Design and Test of ultra-precision inertial sensing and measuring instruments.

**Physics:** Solution of unique instrumentation problems far beyond the scope of routine design or mere extrapolation from existing knowledge.

**Electrical Engineering:** Design and development of miniature, continuously-rotating and servo motors, and special transducers of extreme precision.

**Electronic Engineering:** Development of transistor and vacuum tube circuits as integral parts of instrument systems, and the electronic equipment for the unique and elaborate testing demanded by inertial systems.

*Response to your inquiry will be prompt.*

**Write: Mr. A. Brunetti, Autonetics Engineering Personnel, Dept. 991-10EL, P. O. Box AN, Bellflower, California.**

### **Autonetics**



A DIVISION OF NORTH AMERICAN AVIATION, INC.

AUTOMATIC CONTROLS MAN HAS NEVER BUILT BEFORE

and now a third MEDALIST model

Recently, Marion introduced a new concept in panel meter design, successfully combining for the first time greater readability with distinctive "color harmony" styling. These "MEDALIST" meters were made available in standard 2½ and 3½ inch sizes, interchangeable with ASA/MIL type mounting.



## marion MM1 1½" MEDALIST\*

The MM1, shown actual size, provides scale length equal to or greater than most 2½" meters . . . and up to 50% more scale length than 1½" conventional meters. The new 1½" Medalist is available in all standard ranges including self-contained DC A-meters and rectifier-type AC voltmeters. Basic mechanism of the MM1 is the Marion "Coaxial" MEP2-C, which assures performance and durability far surpassing conventional mechanisms. And like the MM2 and MM3, the MM1 is offered in a variety of standard and special case colors. Easy mounting is accomplished by a threaded ring.

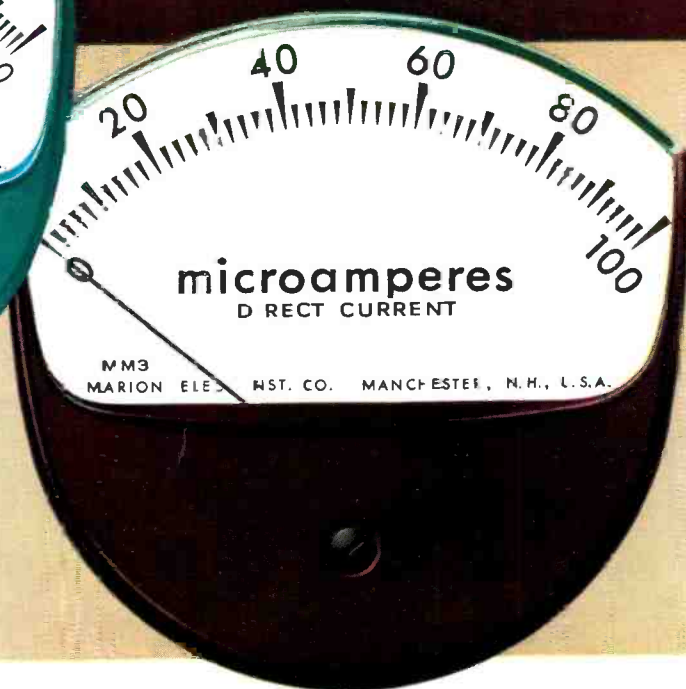
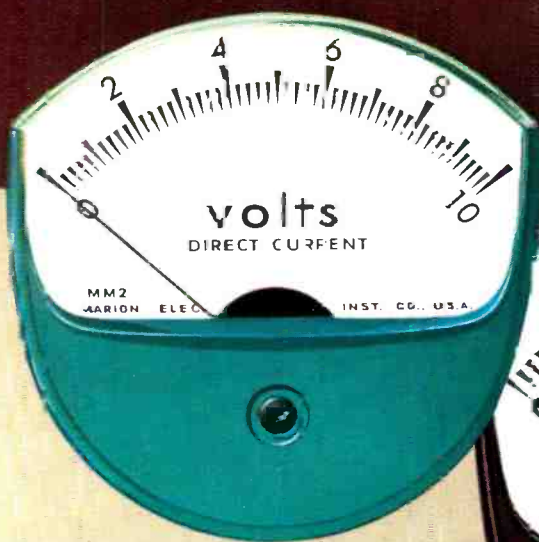

Metalists shown actual size



marion electrical instrument company  
GRENIER FIELD, Manchester, New Hampshire

MM1 1 1/2"

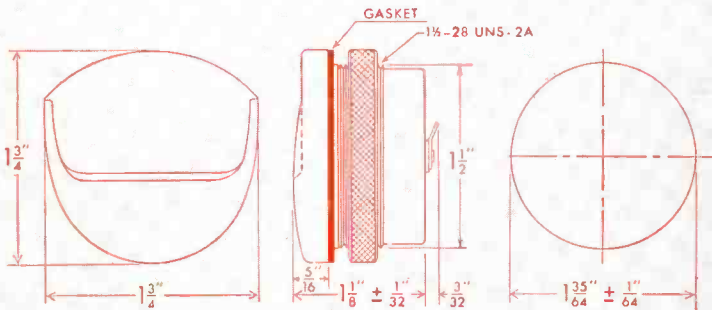

MM2 2 1/2"

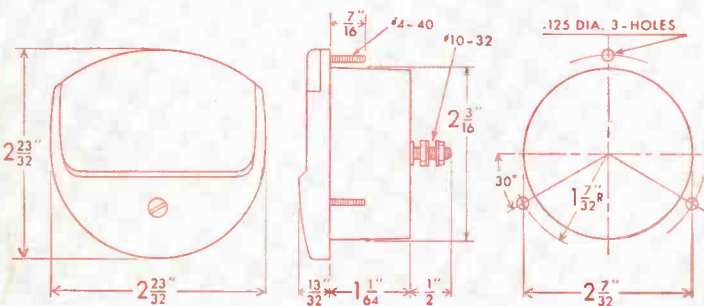

MM3 3 1/2"

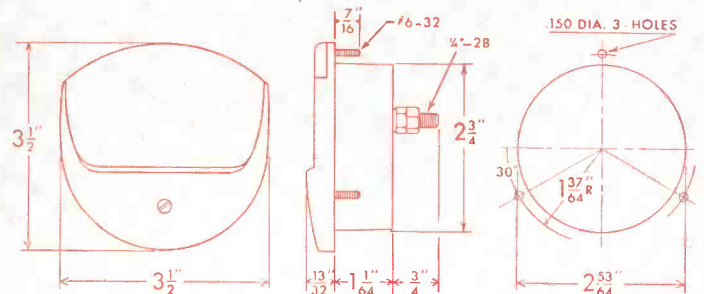

THESE ARE ACTUAL SIZE ILLUSTRATIONS OF THE MM1, MM2 AND MM3 DIALS. USE THEM WITH YOUR OWN TRADEMARK AND SCALE CONFIGURATION TO VISUALIZE A MEDALIST IN YOUR APPLICATION.

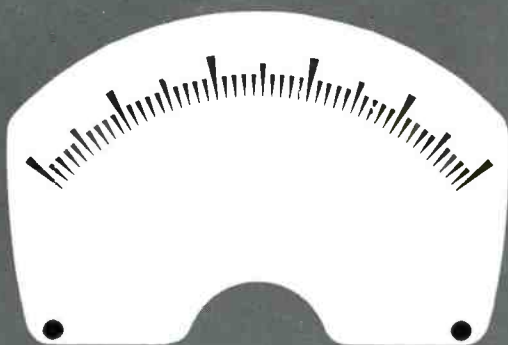

**marion MEDALIST\* meters... "setting new standards"**

*descriptive data*

**CONSTRUCTION**

Undesirable shadows are eliminated and greater natural dial illumination is provided by the use of crystal clear, high temperature Plexiglas fronts. Longer dial arc and distinctive markings provide greater readability in these space-saving meters.

**COLORS**

All "MEDALIST" meters are available in a wide choice of standard colors to harmonize with your equipment. Custom case and dial colors to match your individual requirements can also be supplied.

**RANGES**

"MEDALIST" meters are supplied in all standard DC ranges of microamperes, milliamperes, amperes, millivolts, volts, kilovolts, and AC rectifier types including VU and DB meters.

\*T.M. Reg. U.S. Pat. Off. U.S. & Foreign Patents

†Reg. T.M. Rohm & Haas Co.

Copyright © 1956 Marion



**marion meters**  
marion electrical instrument company  
GRENIER FIELD, Manchester, New Hampshire





**TYPICAL OPERATION**  
(Frequencies up to 175 Mc per tube)

	Class-C CW or FM Phone	Class AB, R-F Linear	Class-C AM Phone
D-C Plate Voltage	2000 volts	2000 volts	1500 volts
D-C Screen Voltage	250 volts	350 volts	250 volts
D-C Grid Voltage	-90 volts	-50 volts	-100 volts
D-C Plate Current	250 ma	100 ma	200 ma
D-C Screen Current	25 ma	250 ma	25 ma
D-C Grid Current	27 ma	15 ma	17 ma
Peak R-F Grid Voltage (approx.)	115 volts	50 volts	121 volts
Driving Power	2.8 watts	0 watts	2.1 watts
Plate Power Input	500 watts	175 watts	300 watts
Plate Power Output	410 watts	325 watts	250 watts

## Meet Eimac's New Ceramic Power Tetrode

Dependability and performance put the new Eimac 4CX300A in a class by itself. Ceramic-metal construction, along with Eimac's high temperature processing techniques, means a "harder," cleaner tetrode. It inhibits deterioration of electrical characteristics while the tube operates continuously at an envelope temperature of 250°C. And it provides the ruggedness that enables the 4CX300A to take 11 millisecond, 50g shocks without internal shorts or mechanical damage. Featuring extremely low series lead inductance, the

4CX300A functions at full ratings through 500 megacycles, and operates over a wide range of plate voltages — 500 to 2000 volts — with power inputs from 125 to 500 watts.

Shown with the 4CX300A is its new Eimac air system socket. In addition to providing the optimum in cooling arrangements, this air socket employs a screen-to-cathode bypass capacitor for stable high-gain operation, a lock-in socketing action, and extremely low inductance terminals.

For further information contact our Application Engineering Department.



**EITEL-McCULLOUGH, INC.**  
SAN BRUNO CALIFORNIA  
The World's Largest Manufacturer of Transmitting Tubes

# NEW GENERAL ELECTRIC MOTOR-IMPROVED PERFORMANCE,

WITH General Electric's three new advanced-type thyratrons, the electronic motor-control designer can work to new, high standards of circuit efficiency. Built into the GL-6807, 8, and 9 are such basic tube improvements as outside-air cooling of anode and grid . . . solidly brazed anode terminal . . . metal-to-glass-bonded internal tube structure.

Here are cooler-operating, longer-life thyratrons than any built before. Three base designs—pin, spade-lug, flying terminal—give application flexibility. Still more important . . . price of the tubes is down! The GL-6807, 8, and 9 come to you for 16% less

than the 5545 they replace. New, more efficient manufacturing methods have made this possible.

General Electric leadership in thyratrons is exemplified by these three new motor-control types. They do a better job, and do it for less. Also, they increase G-E type selection—always the industry's largest—to 46 thyratrons, enabling you to pinpoint every control and circuit requirement.

A convenient selection chart has been prepared to help you find the exact thyatron you need. Write to *Electronic Components Division, General Electric Company, Schenectady 5, New York.*

This mammoth planer-miller depends on new-design General Electric thyratrons to provide efficient and flexible motor control for finishing steam-turbine shells. Here a large turbine casting is moved through the planing phase of the machine's operation. ▶

Micro-milling a casting joint. A cut  $\frac{4}{1000}$ " deep, 10" wide, is being taken at a steady rate of four inches per minute. The machinist guides each move of cutter and casting electronically, by means of a push-button control panel. ▼

A maintenance electrician checks four General Electric GL-6807 thyatron tubes in the planer-miller control cabinet. These new G-E motor-control thyratrons are available with three different base structures, as shown at lower right. ▼

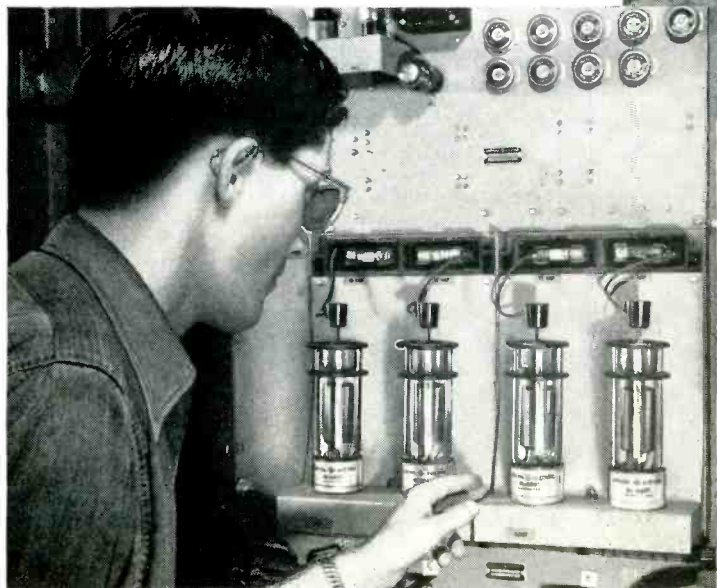
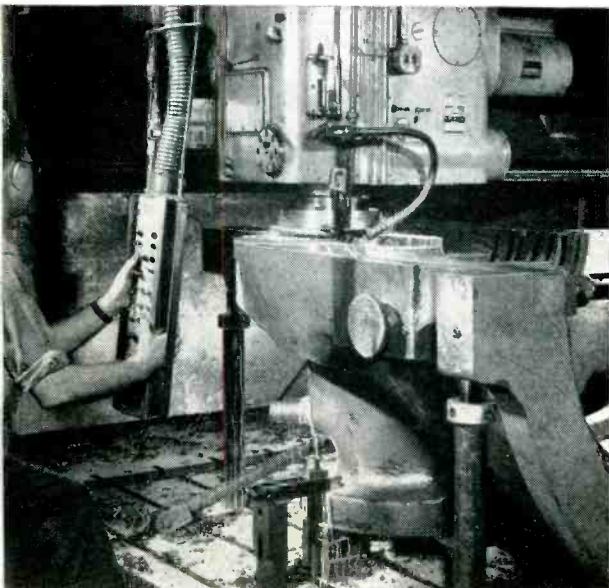
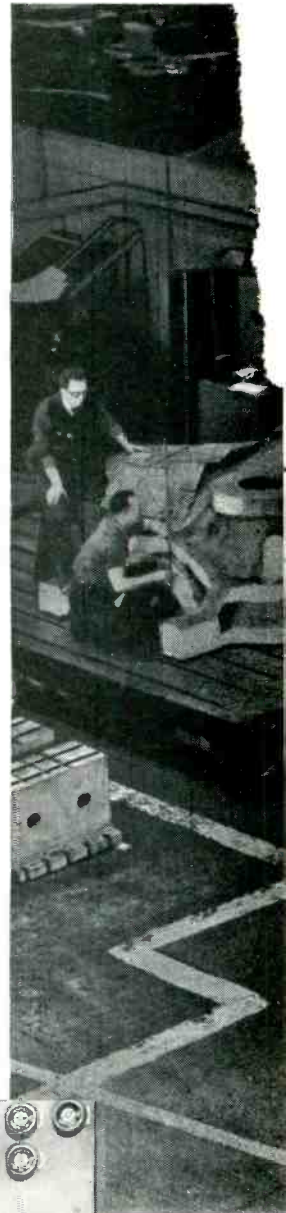

# CONTROL THYRATRONS GIVE WIDEN DESIGNERS' CHOICE OF TYPES!

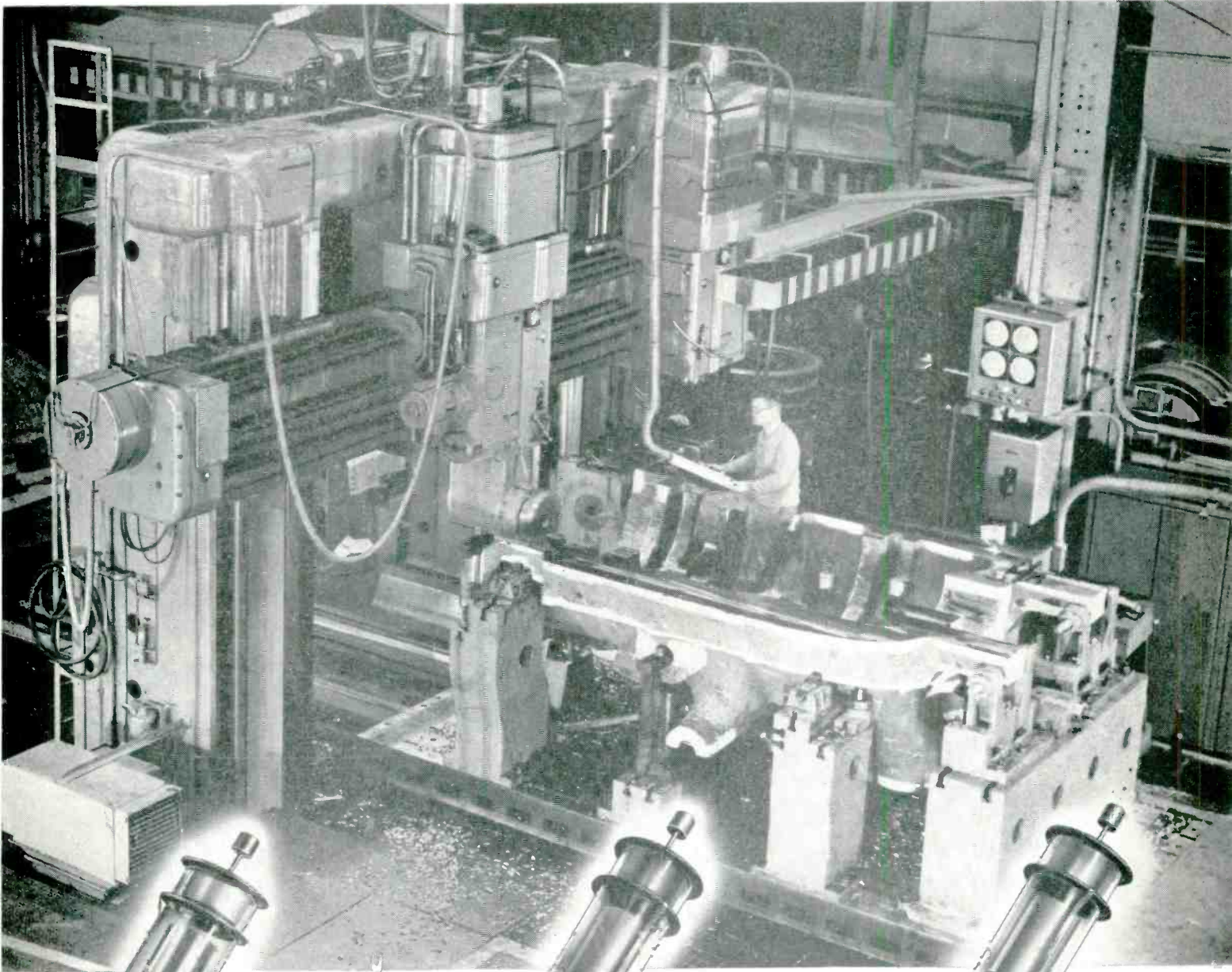

**GL-6807**

Replaces the 5545; has identical ratings. A conventional 9-pin base type.



**GL-6808**

Bracket-mounted with flying leads. Same tube design, ratings as GL-6807.



**GL-6809**

Equipped with spade-lug terminals. Same tube design, ratings as GL-6807.

*Progress Is Our Most Important Product*

**GENERAL**  **ELECTRIC**

# Splitting

FOR ACCURATE MEASUREMENT OF

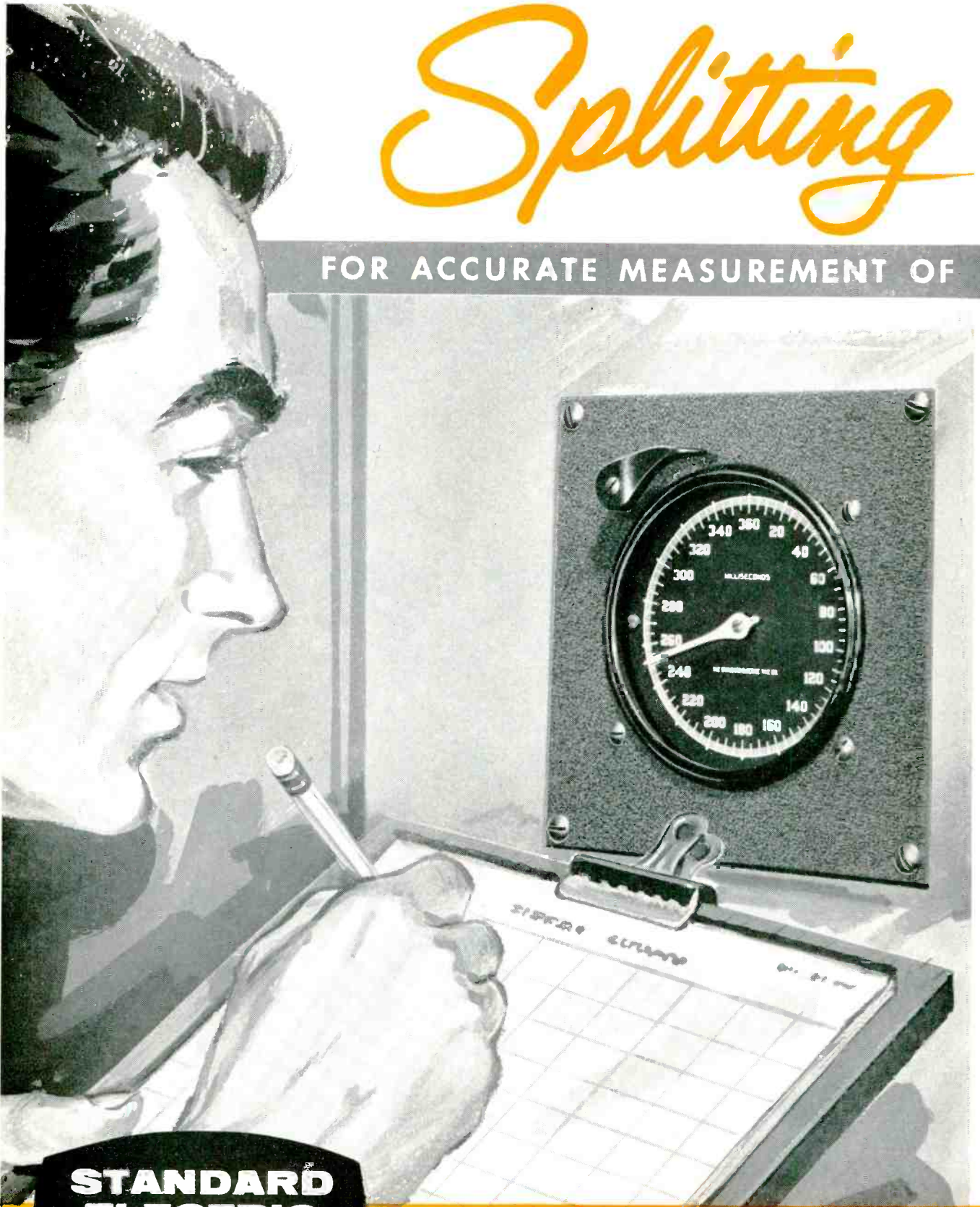

**STANDARD  
ELECTRIC**  
TIME COMPANY  
Springfield 2,  
Massachusetts

SINCE 1884







## THE STANDARD PRECISION TIMER

is the indispensable STOP Watch in laboratory and test cell, on experimental nuclear projects, precision production, check and final inspection. Many important applications in almost every industrial plant and research laboratory.

# Split Seconds

ELAPSED TIME... AS CLOSE AS 0.001 OF A SECOND

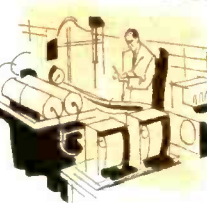
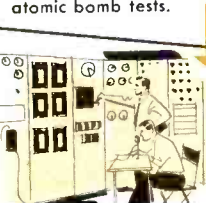
**PRACTICALLY ALL** Representative Manufacturing, Processing and Research Plants  
USE STANDARD PRECISION TIMERS

	<p>At one of the world's largest automotive manufacturers — timing test action in automatic transmission research.</p>		<p>It is our frank belief that literally hundreds of concerns have not yet scratched the surface of usefulness to which Standard Precision Timers can be put to work in their plants.</p>	
<p>For Glenn L. Martin Co.'s Gunnery Trainer — in 12-channel Playback System designed by Cook Research Laboratories.</p>		<p>At Eastman Kodak Co. — timing photo cell controlled exposures in automatic photo printing machine.</p> <p>At Yucca Pass, Nevada Proving Grounds — helping maintain split-second control of atomic bomb tests.</p>		<p>At General Electric Co. — Trumbull Division — measuring operating time of circuit breakers.</p> <p>In Bell Telephone offices throughout the U. S. — timing elements required to complete telephone connections.</p>
	<p>At Bendix — Westinghouse Research Dept. laboratories — measuring brake application and release time to 1/100th of a second.</p>		<p>At American Brass Co. — indicating metallurgical analysis in Direct Reading Spectroscope developed by Baird Associates.</p>	

World's most accurate and rugged time measuring instrument. Built in many different and advanced designs to meet practically every need of precision time measurement. Requires minimum maintenance.

Synchronous motor drive. Electric clutch controlled by manual switch, automatic switch or output of electronic tubes. Manual or electric zero reset.

Model	Scale Divisions	Totalizes	Accuracy
S-100	1/5 sec.	6000 sec.	±.1 sec.
S-60	1/5 sec.	60 min.	±.1 sec.
SM-60	1/100 min.	60 min.	±.002 min.
S-10	1/10 sec.	1000 sec.	±.02 sec.
S-6	1/100 min.	10 min.	±.0002 min.
S-1	1/100 sec.	60 sec.	±.01 sec.
MST	1/1000 sec.	.360 sec.	±.001 sec.
MST-500	1/1000 sec.	30 sec.	±.002 sec.

**SEND TODAY** for Bulletin #198 describing entire line with partial list of thousands of customers, and summary of some of the most frequent (and some of the most unusual) ways they use STANDARD ELECTRIC TIMERS.

**The STANDARD ELECTRIC TIME Co.**  
97 Logan St., Springfield 2, Mass.

Please send Bulletin 198 describing your line of instruments for measuring elapsed time as close as 0.001 seconds.

Name.....Title.....

Firm.....

Address.....

We suggest you check your requirements for Standard Timers and other products today. Your order or inquiry will receive prompt attention.





# how DAVIES puts magnetic tape to work



... in an automatic recorder, reproducer ...  
vibration analysis ... a dead time simulator  
... a casualty recorder

## you push the button

With automation putting more and more information on magnetic tape, the tape equipment itself has become a fit subject for automation. Which is why we developed automatically programmed tape equipment. The transport starts, stops, and rewinds automatically . . . scans any track or combination of tracks once or any number of times . . . automatically matches tape speed to requirements over a wide range . . . permits fast search and slow read-out . . . and all without human attention. It can also be programmed for continuous recording over hundreds of hours, recording on one track, rewinding, restarting, recording on the next track, etc., without attention.

All this we can do with standard Davies shelf-type equipment. But if your needs are very special, we can also build to satisfy them from the ground up.

## what's in a bump

Vibration in an automobile is annoying . . . in a plane, worrisome . . . and in a missile, downright expensive! Vibration, as a result, has been subjected to considerable and serious study. Should you ever want to analyze vibration, the first thing to do is *catch the vibration*. Whether you put a Davies recorder in the vehicle (and they can be installed in missiles) . . . or at the other end of a telemeter link on the ground, somehow get the vibration on magnetic tape. Now you have a lot of complex waves, and you're ready to analyze them, a job best accomplished in the immediate vicinity of a Davies Auto-

matic Wave Analyzer. Fed with a complex wave, it hands back a complete Fourier analysis, graphing every component from 3 to 10,000 cps, and basing the results, depending on your whim, on either linear or square law response. We'll sell you the wave analyzer alone if you wish, but we'd just as soon work up the complete system . . . recording equipment, reproducing equipment, analyzer . . . even the tape.

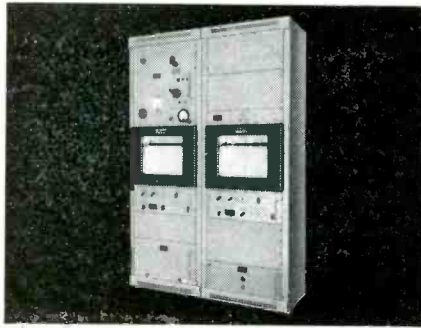

Davies Automatic Wave Analyzer

## the voltage goes round and round

Our dead time simulator is particularly appreciated by analog computers in need of a variable time delay. In heat exchanger problems, for example, it can be rigged to accept a voltage simulating pump speed, and voltages representing temperatures at various points in the exchanger, from the computer. After delaying the temperature analogs for a time inversely proportional to the pump speed analog, back they go to a much relieved computer.

## where were you when?

A thorough analysis of process failures can considerably reduce

the chance of future failures. Thus the market for continuous logging devices in the process industries. But continuous logging facilities are extremely expensive if the information they print is only important as it applies to events immediately preceding an abnormal condition. For the job of closing the barn door only when a robbery is in the offing, we propose our Casualty Recorder, which works like this: Conditions at critical process points are continuously recorded on the many tracks of a loop of magnetic tape, with loop length determined by the amount of hindsight desired. In normal operation, information is recorded on the tape, passes around the loop, is erased, and new readings are recorded. When an off-normal situation develops, information is fed to suitable read-out devices before erasure for later examination. While this system gives you only the data you need, that's all you have to pay for.

COMPLETE DETAILS on the systems covered are available. But it's difficult in booklet form to give any adequate idea of the seemingly limitless applicability of magnetic tape systems in data handling. We'll be happy to pass on what literature is available, but we'd rather discuss your data accumulation, storage, or reduction problem with you directly. Just name the time and place.



Davies

LABORATORIES, INCORPORATED  
10721 HANNA STREET • BELTSVILLE, MARYLAND  
WEBSTER 5-2700

# Miniature DC VTVM uses AIRPAX chopper

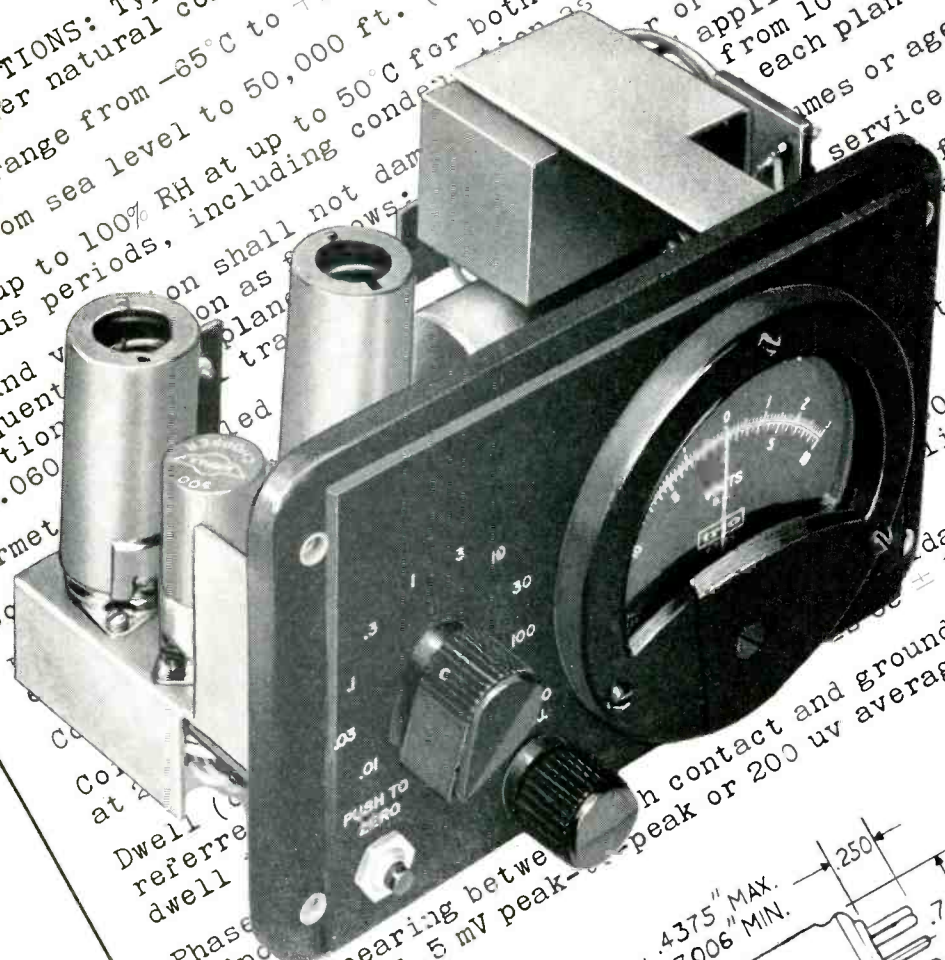

APPLICATIONS FOR  
 TIONS: Type 300 chopper opera  
 er natural combinations of the fo  
 range from -65°C to +100°C. (30 in. up to 3.4 in.  
 up to 100% RH at up to 50°C for both in  
 us periods, including condensation as wa  
 and v... on shall not dam... or imp... both  
 uent... plan... applied... from 10 to 55 pps  
 .060... tra... as wa... for frost.  
 each plane.  
 service life.

ts RMS applied  
 0 to 165 degrees  
 15 degrees;  
 ad voltage and the  
 across 1 MEG does  
 average from 20 CPS to 50 KC.  
 h contact and ground  
 peak or 200 uv average

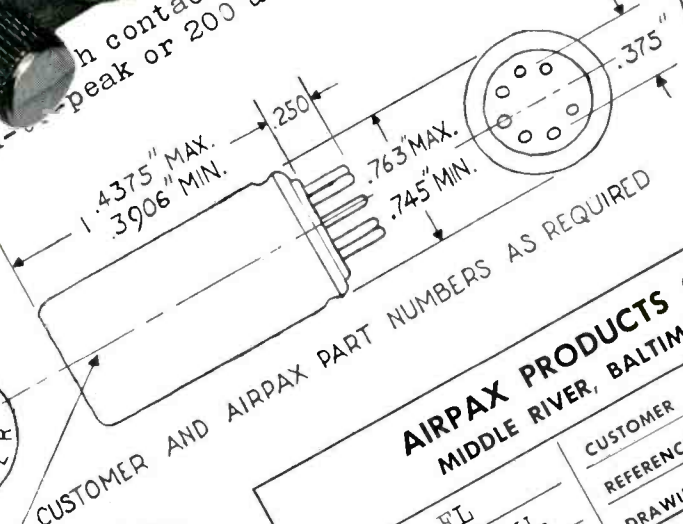

<b>AIRPAX PRODUCTS COMPANY</b> MIDDLE RIVER, BALTIMORE 20, MD.	
DRAWN FL	CUSTOMER
APPROVED D.H.H.	REFERENCE AIRPAX SPEC. 21
DATE 11 Feb. 55	DRAWING NUMBER 300

## RATING ON TYPE 300 CHOPPER

Drive: 6.3 volts at 400 CPS  
 Contacts: up to 100 volts at 2 ma  
 Dwell Time: 147 electrical degrees  
 Phase Angle: 65 electrical degrees lagging  
 Noise: 200 microvolts average across a 1 megohm resistance into a band from 20 CPS to 50 KC from each contact to ground

Hermetically sealed for maximum life under all ambient conditions. Available to plug into a 7-pin miniature tube socket, or with solder lugs and flange mount.

## Zero Drift Is 0.5% Maximum

An Airpax Type 300 chopper gives this panel-mounting instrument several unusual characteristics. It has a 5-megohm input impedance, yet only 0.5% maximum drift. With it you can read as low as 500 DC microvolts and as high as 300 DC volts, both to an accuracy of 2%.

You may have another equipment that can benefit from a chopper to convert DC to AC. Why not discuss your problem with us today? Airpax makes the chopper (Trio Laboratories, Seaford, New York makes the VTVM).



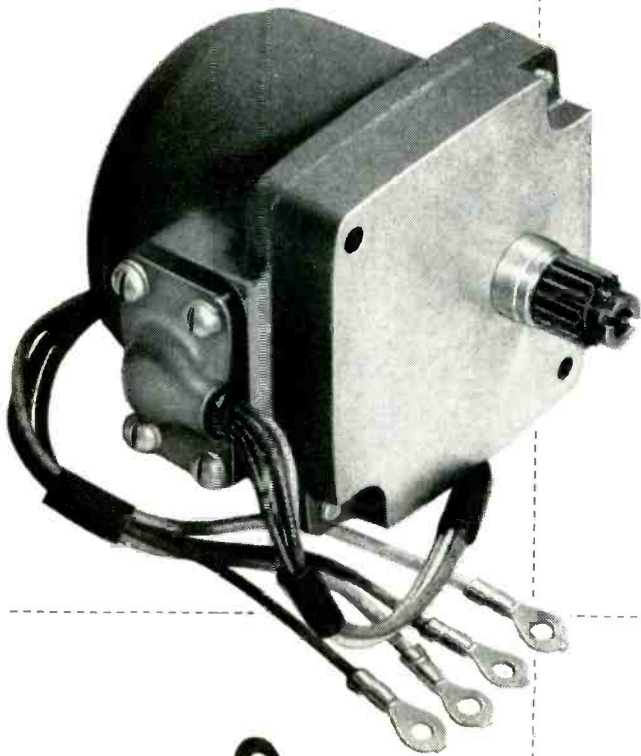

**For positive positioning  
use Brown  
2-phase motors  
in your servomechanisms**

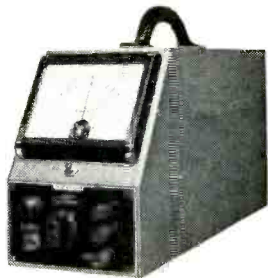

**ElectroniK Null Indicator**

Modern successor to the spotlight galvanometer. Immune to vibration . . . self-protected from overloads. Needs no leveling, no special mounting. Ideal for lab or factory. Sensitivity 0.001 microamp or 1 microvolt per mm. Price \$175.00 f.o.b. Philadelphia.

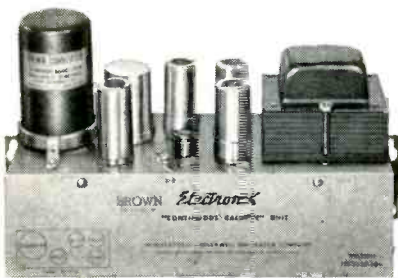

**Brown Servo Amplifiers**

For instrument and computer servoloops. Convert low-level d-c input signal to ac, and amplify it to power level to drive a Brown servo motor. Extremely low stray pickup, high stability, excellent sensitivity, fast response. Four models with gains of 1, 4, 12 or 40  $\pm$  10%. Choice of 4 input impedances from 400 to 50,000 ohms. Prices from \$98.50.

**N**EEED up to 85 inch-ounces of torque, at low speeds—for remote positioning in servos, computers, null circuits?

Brown 2-phase reversible motors are ideal for these applications. They're the same design that has given years of continuous service in thousands of Brown *ElectroniK* instruments throughout industry. And continuing refinements make them better than ever.

Long-life needle bearings reduce friction and maintenance. Improved gear trains deliver a smooth flow of power. Better seal, better lubrication, simpler and more attractive housing . . . all add to greater value in the latest models of Brown servo motors.

Shaft speeds of 27, 54, 162, 333 or 1620 rpm are available. Many variations in design of pinion, shaft, leads and materials can be supplied for special applications.

Power input is 115 volts, 60 cycles . . . 25-cycle model also available. Line field takes 11 watts; amplifier field 2.5 watts. Motor load impedance averages 12,000 ohms.

Check the table below for the models you need. Order single units for development work, or thousands for production runs. Prices from \$42.00 (even more favorable depending on quantity).

MINNEAPOLIS-HONEYWELL REGULATOR CO., *Industrial Division*, Wayne and Windrim Avenues, Philadelphia 44, Pa.

No-load speed—rpm	27	54	162	333	1620
Rated torque—in. oz.	30	15	5	4	5
Max torque—in. oz.	85	43	19	11	9
rpm for max power	15	31	92	190	900



MINNEAPOLIS  
**Honeywell**  
BROWN INSTRUMENTS

*First in Controls*



# MILLIONS OF VARIABLE RESISTORS

## for every commercial and military need

• A world-wide reputation . . . for economical uniform high quality assembly . . . on a precision mass production basis . . . by 1500 skilled, trained-on-the-job specialists . . . to your exact individual specification.

• 315,000 sq. ft. of plant area devoted to variable resistors.  
 • Exceptionally good delivery cycle . . . on both commercial and military orders.  
 • Write for complete 62 page catalog today.

### Typical Bushing Mounted Controls



Miniaturized 3/4" diameter composition



15/16" diameter composition



15/16" diameter composition with SPST switch



1-1/8" diameter concentric tandem tone switch and composition variable resistor with SPST on-off switch



1-1/8" diameter composition with SPST switch



1-17/64" diameter 2 watt wirewound



1-17/32" diameter 4 watt wirewound

### Typical Ear-Mounted Controls



Molded shaft twist ear mounted 15/16" diameter composition



Follow shaft twist ear mounted 15/16" diameter composition for screwdriver adjustment



Twist ear mounted 15/16" diameter composition with flattened shaft for push-on knobs



Twist ear mounted 15/16" diameter composition with SPST switch



Twist ear mounted 15/16" diameter pre-set tandem



Miniaturized clinch ear mounted composition



Miniaturized clinch ear mounted composition with SPST switch

### Typical Printed Circuit Controls



Solder or clinch ear mounted 15/16" diameter composition with flush shaft



Bushing mounted 15/16" diameter concentric tandem composition with SPST switch



Self-supporting snap-in mounted 45/16" diameter composition



Self-supporting snap-in bracket mounted 15/16" diameter composition with SPST switch

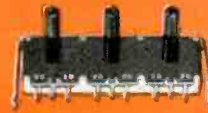

Self-supporting snap-in mounted compact 3-section multiple composition



Miniaturized bushing mounted 3/4" diameter composition

### Terminals for Wire Wrapping



Bushing mounted 15/16" diameter composition with SPST switch

### Typical Military Controls



Miniaturized 3/4" diameter 1/2 watt composition



15/16" diameter 1 watt composition



15/16" diameter composition with water-seal between shaft and bushing and panel



1-1/5" diameter composition



1-1/5" diameter 2 watt composition



1-1/64" diameter 2 watt wirewound with locking type bushing



1-1/32" diameter 4 watt wirewound

A CTS control can be tailored to your specific requirement. Let CTS SPECIALISTS help solve your current control problems. Write or phone today.

**WEST COAST SUBSIDIARY**  
 Chicago Telephone of California, Inc.  
 105 Pasadena Avenue  
 South Pasadena, Calif.  
 L.A. Phone: Clinton 5-7186  
 TWX LA 1105  
**CANADIAN SUBSIDIARY**  
 C. C. Meredith & Co., Ltd.  
 Streetsville, Ontario  
 Phone: 310

**EAST COAST OFFICE**  
 130 N. Broadway  
 Camden 2, New Jersey  
 Phone: Woodlawn 6-1668  
 TWX No. Camden NJ 380  
 Phila. Phone: Market 7-3129  
**SOUTHWESTERN U.S.A.**  
 John A. Green Company  
 137 Parkhouse  
 Dallas 7, Texas  
 Phone: Riverside 3266

**SOUTH AMERICA**  
 Jose Luis Pontet  
 Buenos Aires, Argentina  
 Montevideo, Uruguay  
 Rio de Janeiro, Brazil  
 Sao Paulo, Brazil  
**OTHER EXPORT**  
 Sylvan Ginsbury  
 8 West 40th Street  
 New York 18, New York  
 Phone: Pennsylvania 6-8239

Variable resistors shown 1/3 actual size



**CHICAGO TELEPHONE SUPPLY**  
*Corporation*

ELKHART • INDIANA

*The Exclusive Specialists in Precision Mass Production of Variable Resistors • Founded 1896*

# solving logical problems with Burroughs pulse control systems

detecting coincidence between  
two random trains of pulses

The diagram below shows a quick, easy logical method of detecting coincidence between random pulses on two different lines—pulses which might occur simultaneously, well within the switching time of even the fastest units. In this case, the systems approach proved to be more feasible than increasing the precision of the components.

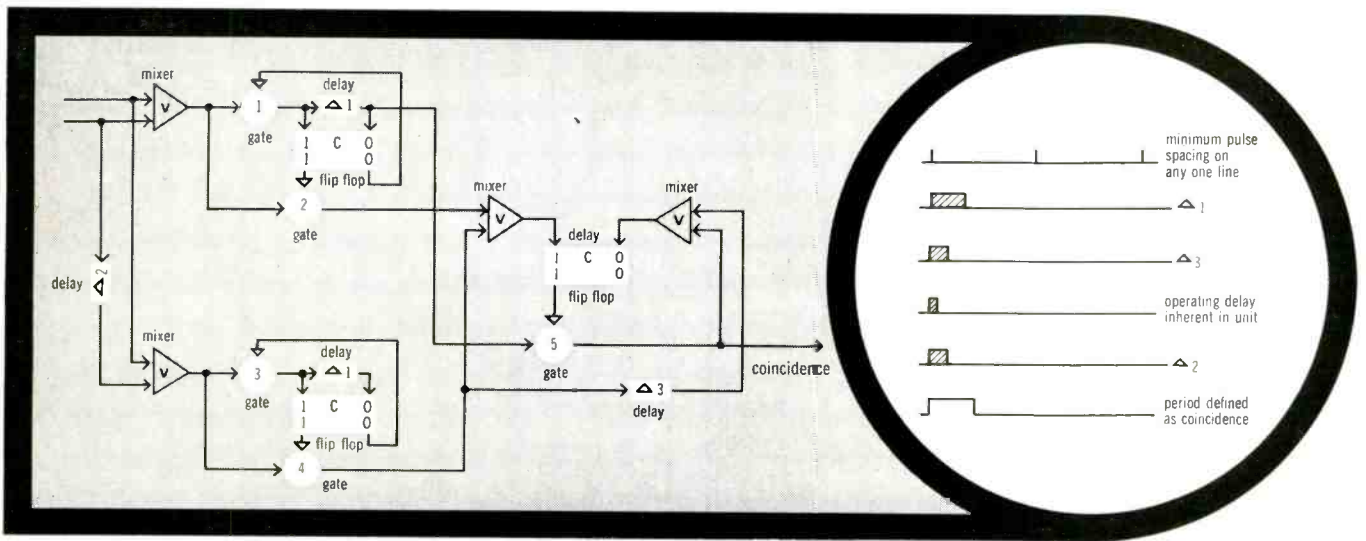

TOOLS FOR ENGINEERS



Logical problems such as this one still tie up most of today's engineers... making them design breadboard equipment to prove out their solutions... relegating their creativeness to secondary projects. Burroughs Pulse Control Systems cut through these time-consuming operations by giving the engineer a quick, logical method for checking his results.

Each unit in the Burroughs System represents a basic logical function. The engineer has only to hook up a number of these units to correspond with his block diagram, and the solution is ready for proof. Intermediate breadboarding is completely eliminated... his concept is proved or disproved quickly... and he is free to concentrate on the end result.

You can give your engineers this creative edge by letting Burroughs Pulse Control Systems take over the burden of proof. A Burroughs engineer will be glad to call on you—at your convenience—and show you how to save hours of engineering time and production headaches. Or, write for Bulletin 236.

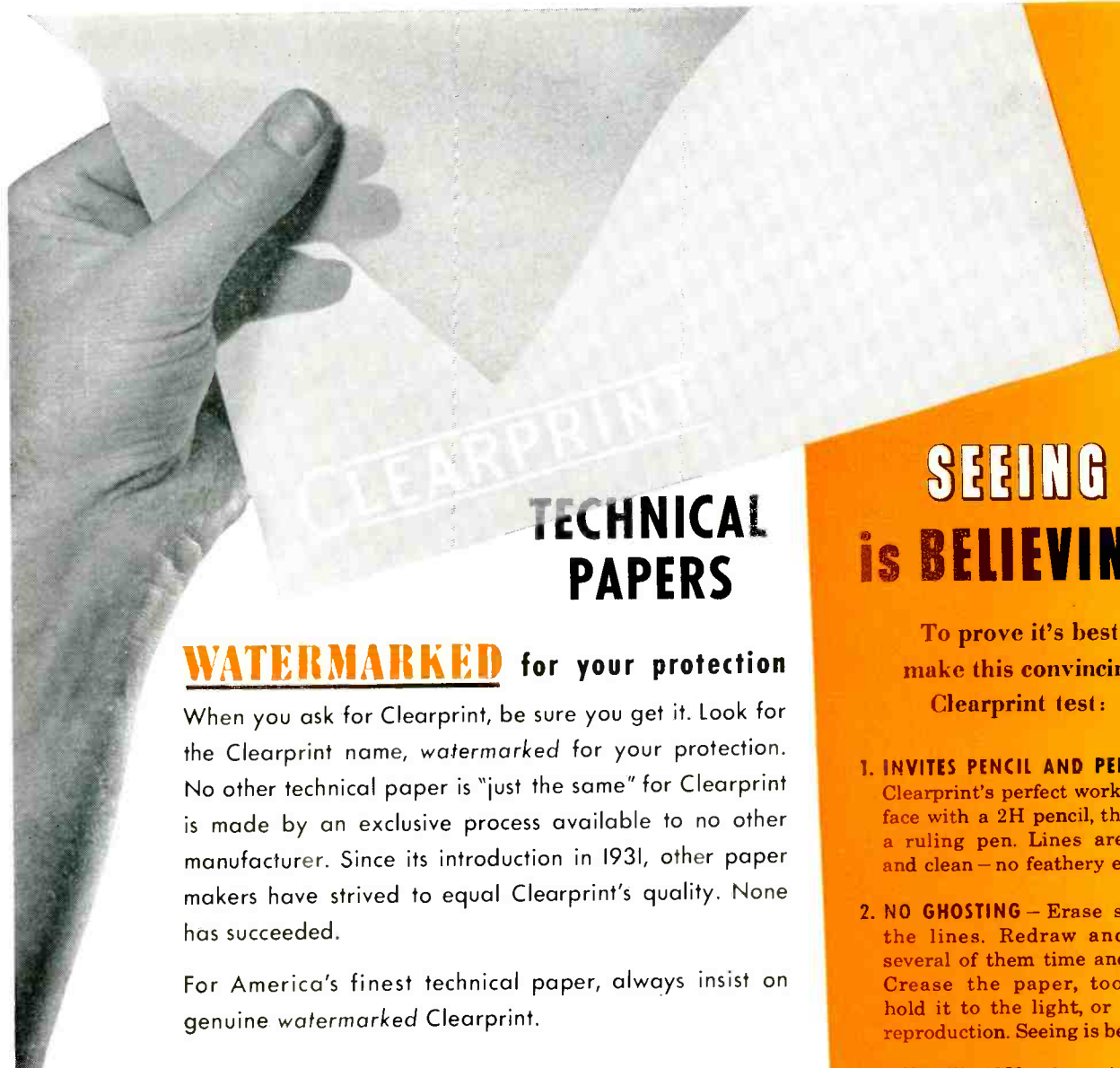

## TECHNICAL PAPERS

### **WATERMARKED** for your protection

When you ask for Clearprint, be sure you get it. Look for the Clearprint name, *watermarked* for your protection. No other technical paper is "just the same" for Clearprint is made by an exclusive process available to no other manufacturer. Since its introduction in 1931, other paper makers have strived to equal Clearprint's quality. None has succeeded.

For America's finest technical paper, always insist on genuine *watermarked* Clearprint.

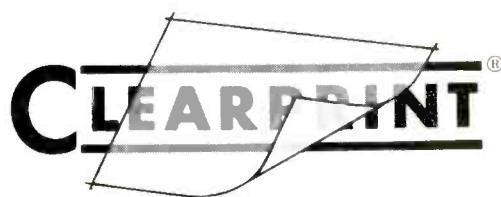

## TECHNICAL PAPER

THERE IS NO SUBSTITUTE — Demand Watermarked Clearprint

## SEEING is BELIEVING!

To prove it's best,  
make this convincing  
Clearprint test:

1. **INVITES PENCIL AND PEN** — Try Clearprint's perfect working surface with a 2H pencil, then with a ruling pen. Lines are sharp and clean — no feathery edges.
2. **NO GHOSTING** — Erase some of the lines. Redraw and erase several of them time and again. Crease the paper, too. Then hold it to the light, or make a reproduction. Seeing is believing!
3. **NEVER CHANGES** — Sheets in use for over 20 years prove Clearprint's amazing stability. Its strength, transparency and printing qualities remain unchanged after extended exposure to age, atmosphere, heat and light.

If you are not using Clearprint now, please make this comparative test on the paper you are using.

There are Clearprint  
Technical Papers for  
every requirement.

Order from your dealer  
today, or write:

### **CLEARPRINT PAPER CO.**

1482 SIXTY-SEVENTH STREET  
EMERYVILLE, CALIFORNIA

MAIL COUPON FOR SAMPLES AND PRICES

(EL)

**CLEARPRINT PAPER CO. 1482 - 67TH STREET, EMERYVILLE, CALIF.**

Send me Clearprint samples, with prices, for the following uses:

NAME \_\_\_\_\_

FIRM \_\_\_\_\_

ADDRESS \_\_\_\_\_

Have your representative call at my office.

CITY \_\_\_\_\_ ZONE \_\_\_\_\_ STATE \_\_\_\_\_

THE  
*Heiland*  
**119 AMPLIFIER SYSTEM  
 FOR OSCILLOGRAPHIC  
 RECORDING**

**COMPARE  
 THESE FEATURES**

**WITH SIMILAR SYSTEMS:**

**TWICE THE SENSITIVITY**— $\frac{1}{2}$  millivolt for full current output

**TWICE THE FREQUENCY RESPONSE**—0 to 1000 c.p.s.

**TEN TIMES THE CURRENT OUTPUT**—50 ma into 20-ohm load

*with*—**EXCELLENT STABILITY**—less than 2% variation with line voltage fluctuation and wide range of ambient temperatures

**Carrier Amplifier Units for:**

- Resistive transducers
- Linear differential transformer pickups
- Variable reluctance gages

**Linear-Integrating Amplifiers for:**

- Self-generating transducers.

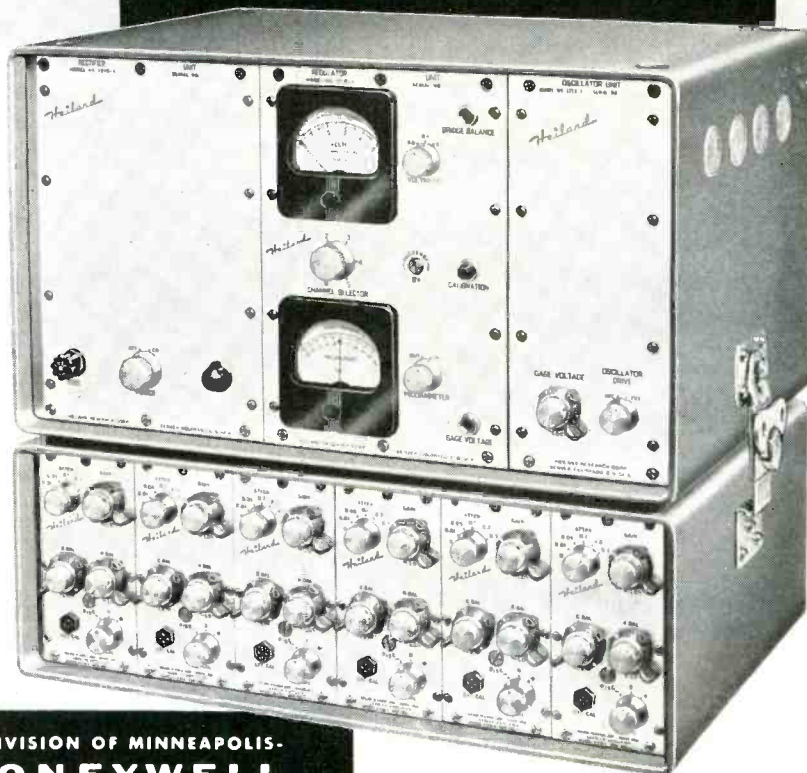

*Heiland*®



A DIVISION OF MINNEAPOLIS-  
**HONEYWELL**  
 5200 E. Evans, Denver 22, Colo.

**FOR ADDITIONAL  
 DETAILS  
 WRITE FOR  
 BULLETIN 101K**

All these features—plus many more—have moved Heiland 119 Amplifier Systems into leadership in the field!

All operating controls are on the front panel; all cabling is on the back panel for handy relay rack or test bench mounting without modification.

The 119 System is flexible to meet present or future needs, since all 6 individual amplifier units within the system are easily removable. You can build your system from the ground up, adding new individual units as your need expands.

In addition, linear-integrate and carrier units are interchangeable within the system case.

**FOR PERFORMANCE AND CONVENIENCE—CHOOSE THE HEILAND 119 AMPLIFIER SYSTEM.**

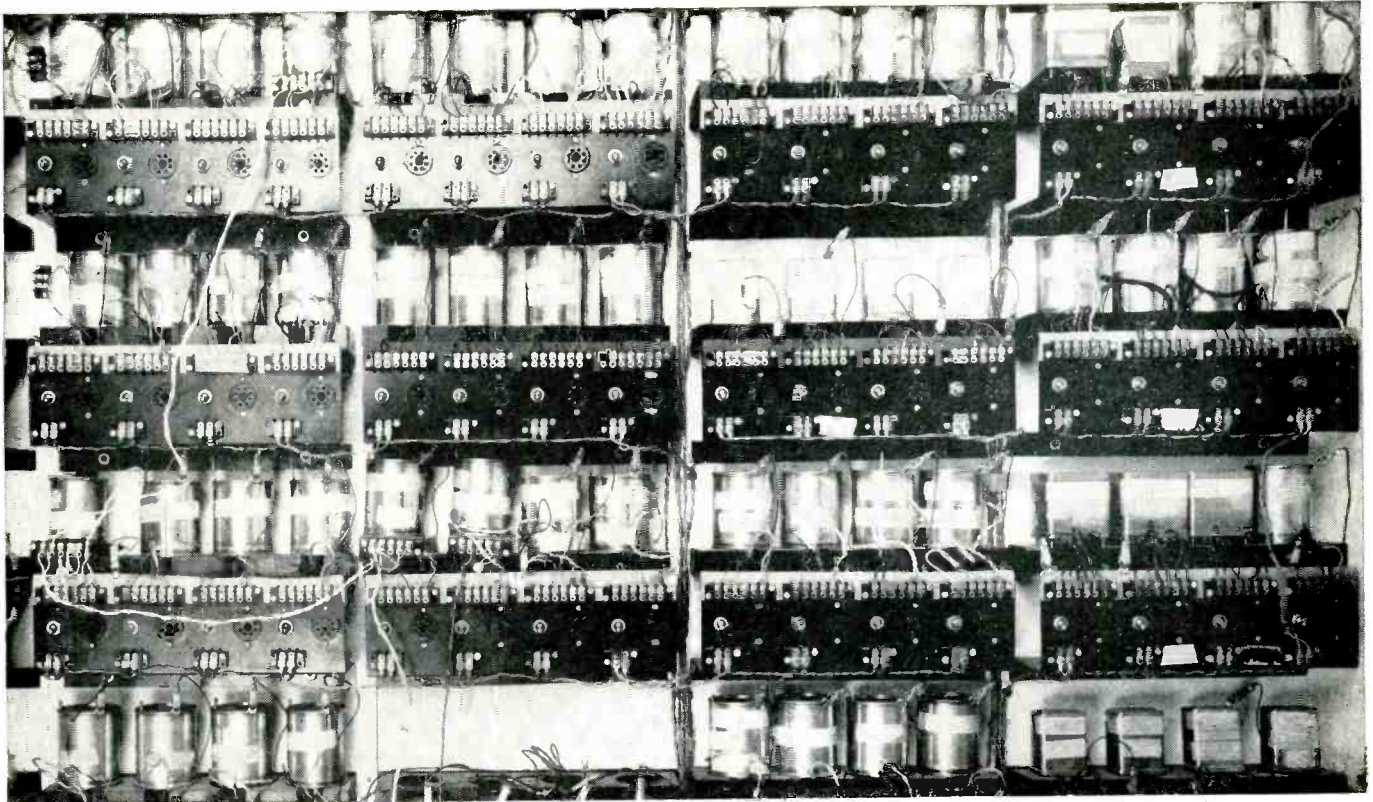

TORTURE TESTS like these for Syncroverter Switches are typical of Bristol's continuing drive for product quality.

## 100 billion operations and they're still going strong!

### Syncroverter Choppers have run almost six years continuously at 400 and 600 cycles per second

That's the laboratory shelf-test record of a group of Bristol's® Syncroverter® Switches that are being run at no load as a test for actual mechanical wear out. They are still operating after almost six years.

These Syncroverter Switches are predecessors of those being used in aircraft fire control systems, guided missiles, electronic instruments, ground control equipment, and many other electronic systems.

Long life is a feature of the miniature Syncroverter Chopper and High-Speed Polar Relay. They are unaffected during severe shock and vibration and are available with the typical operating characteristics shown in the tables at right. They meet a wide variety of requirements. Write for further information on these precision components. Or we'll be glad to discuss specific application problems with you. The Bristol Company, 152 Bristol Road, Waterbury 20, Conn.

#### TYPICAL CHARACTERISTICS

##### Bristol's Syncroverter Switch (covered by patents)

Driving frequency range:	0-2000 cps (400 cps used for these characteristics)
Coil voltage:	6.3V sine, square, pulse wave
Coil current:	55 milliamperes
Coil resistance:	85 ohms
*Phase lag:	$55^\circ \pm 10^\circ$
*Dissymmetry:	Less than 4%
Temperature:	$-55^\circ\text{C}$ to $100^\circ\text{C}$
*Switching time:	$15^\circ = 5^\circ$
Operating position:	Any
Mounting:	Flange or plug-in—fits 7-pin miniature socket

\*These characteristics based on sine-wave excitation



##### Bristol's Syncroverter High-Speed Relay (covered by patents)

Temperature range:	$-55^\circ\text{C}$ to $100^\circ\text{C}$
Operating shock:	30G; 11 milliseconds duration
Vibration:	10-55 cps (see below mounting); 10G
Contact ratings:	Up to 35V, 45 microamperes
Stray contact capacitance:	Less than 15 mmf.
Pull-in time (including bounce):	As low as 200 microseconds
Drop-out time:	300 microseconds
Life:	Over a billion operations under dry-circuit conditions
Mounting:	Octal tube socket; others available, including types for vibration to 2000 cps



# BRISTOL

TRAIL-BLAZERS

IN PROCESS AUTOMATION

AUTOMATIC CONTROLS • RECORDERS • TELIMETERS • SOCKET SCREWS •

CHOPPERS AND HIGH-SPEED RELAYS • AIRCRAFT PRESSURE-OPERATED DEVICES

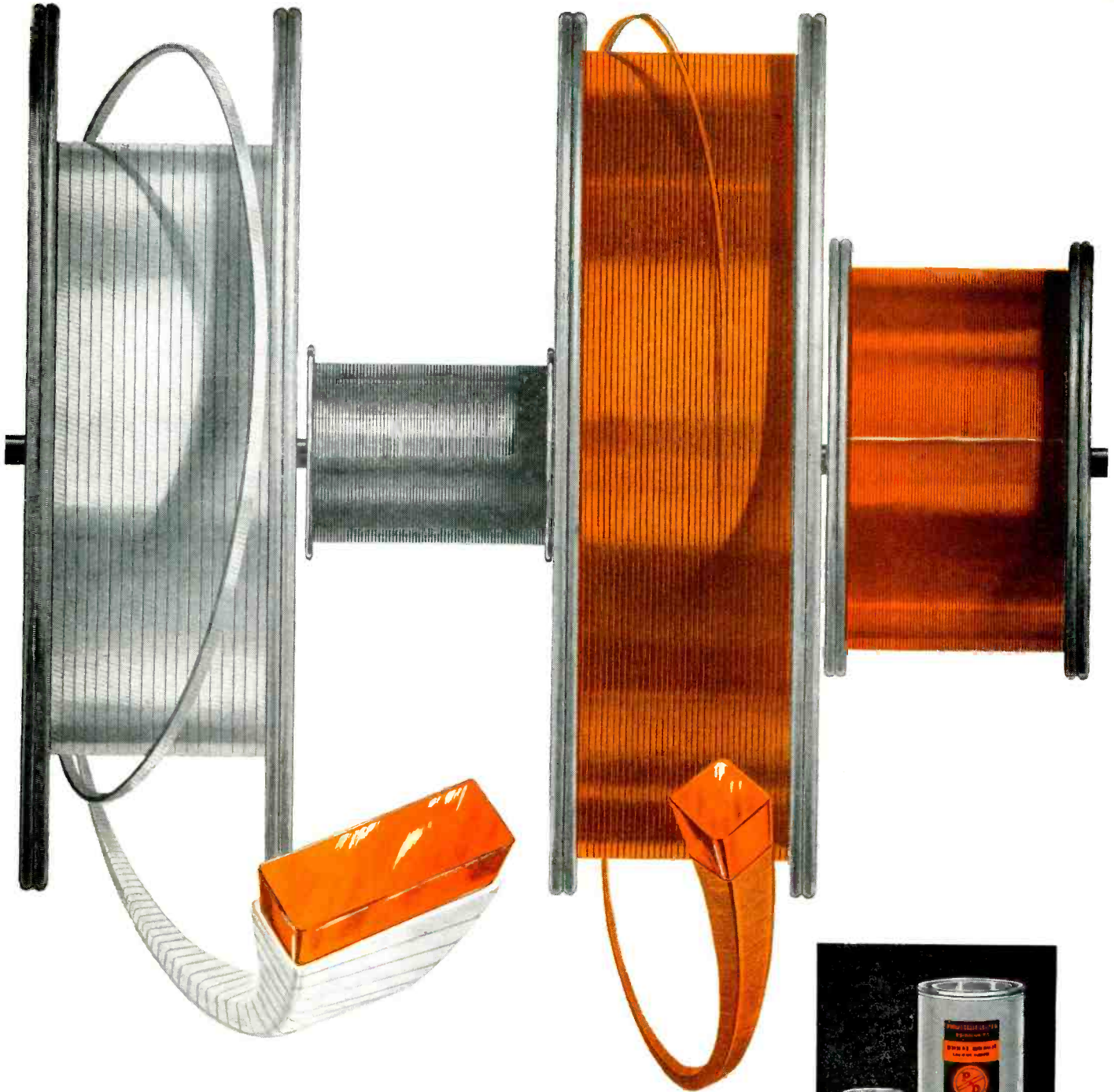

Wire packaged in Phelps Dodge special "Pakeze" containers if required.

*First for Lasting Quality—from Mine to Market!*



*If it Calls for* **MAGNET WIRE**—*Call on* **PHELPS DODGE** *for*  
**INDUSTRY'S MOST COMPLETE,**  
**MOST UP-TO-DATE LINE!**



Every type of insulation to meet design requirements.  
 Enamel • Formvar • Sodereze® • Bondeze® • Daglas® • Thermaleze®  
 Silicone • Paper • Cotton • Multiple Combinations.



Available in all sizes and shapes—round, square, rectangular.  
 Over 400 different types!



Special emphasis on research and development—your assurance  
 of the latest advances in magnet wire.



Vast background of application engineering experience to help  
 solve your problems.



***PHELPS DODGE COPPER PRODUCTS***  
**CORPORATION**

**INCA MANUFACTURING DIVISION**  
 FORT WAYNE, INDIANA

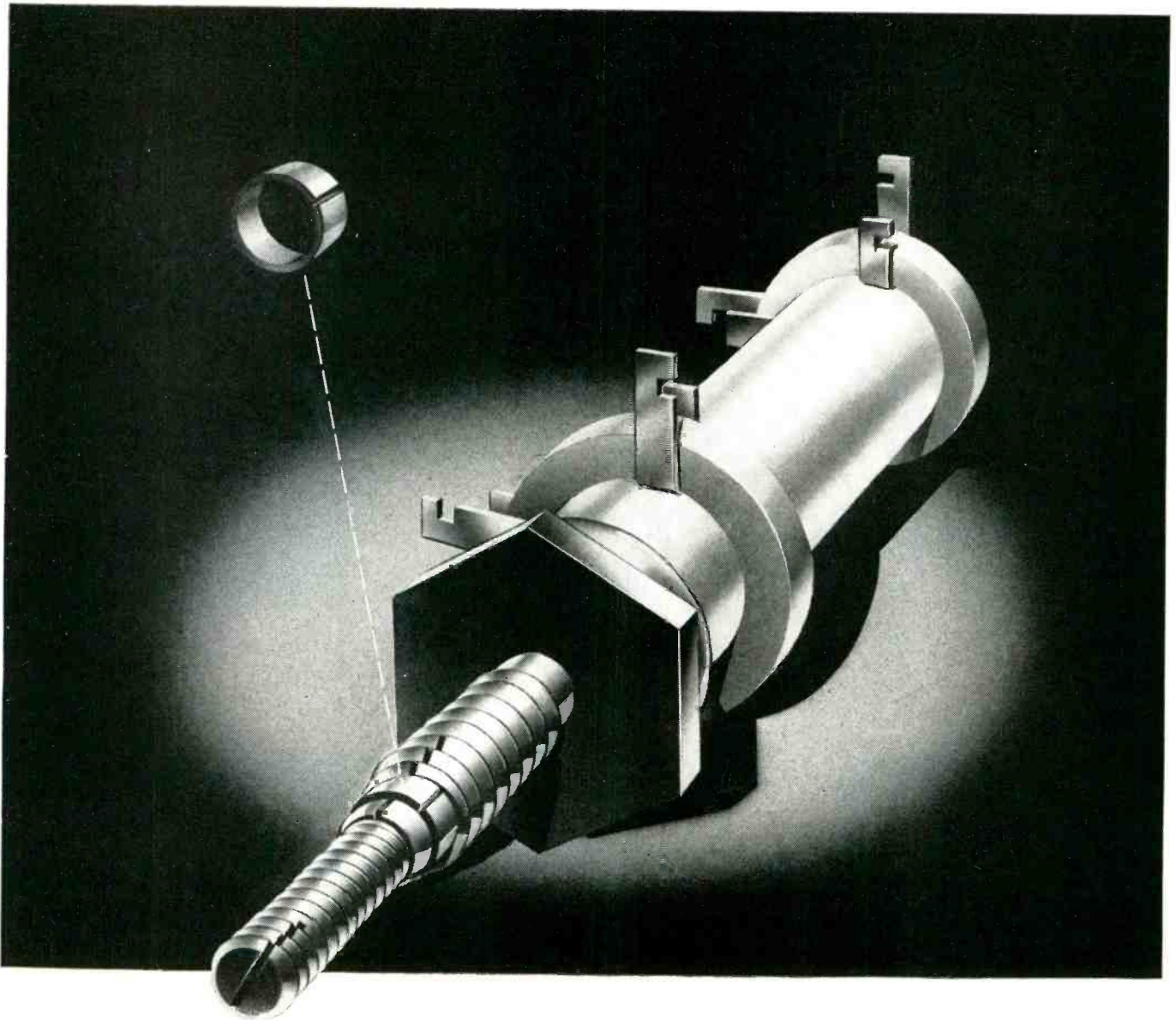

## Always tense but never tired

Again CTC comes up with an advancement for more secure, more effective electronic assemblies. It's the new Perma-Torq\* constant tensioning device for tuning cores of standard CTC ceramic coil forms.

CTC's Perma-Torq, a compression spring of heat treated beryllium copper, has very high resistance to fatigue and keeps coils tuned as set, under extreme shock and vibration. It allows for immediate readjustment without removal or loosening of any mounting nut or locking spring. But most important of all — Perma-Torq like all CTC components is *quality controlled*.

CTC's *quality-control* means you get consistent top quality components. Each step of production is checked, each component part — even though already certified — is checked again. And finally CTC's finished product is checked. That's why CTC can offer you a guaranteed electronic component — standard or custom — whose performance you can depend upon.

CTC researchers and practical experts are always available to help solve

your components problems. For samples, specifications and prices write to Sales Engineering Dept., Cambridge Thermionic Corporation, 437 Concord Ave., Cambridge 38, Mass. On the West Coast contact E. V. Roberts, 5068 West Washington Blvd., Los Angeles 16 or 988 Market St., San Francisco, Cal.

NEW PERMA-TORQ UNITS come completely factory assembled to mounting studs, eliminating the bother of assembling and adjusting separate locking springs. CTC coil forms with Perma-Torq Tensioning Device are designated PLST, PLS5, PLS6 and PLS7, are completely interchangeable with the LST, LS5, LS6 and LS7 series, and are available at no increase in price.

\*Patent pending

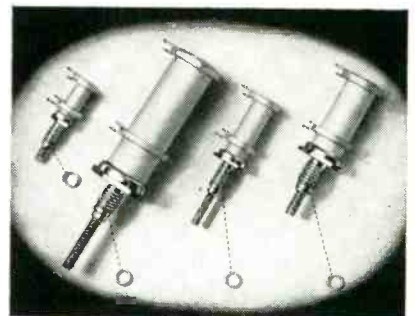

# CTC

**CAMBRIDGE THERMIONIC CORPORATION**

*makers of guaranteed electronic components  
custom or standard*





**NEW!**



BK-3300, BK-3500, BK-3700—ultimate in precision made multichannel heads.



BK-1300, BK-1500 series—up to 25 interleaved channels per inch.

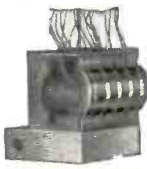

BK-160 series—simple mounting and adjustment, ideal for drum computers.



BK-15C1 series—compact, wafer-thin permit individual adjustment.



BK-90C, BK-1000, BK-1200 series—variety of types for single channel applications.

## How **Brush Magnetic Heads** improve product performance

Microscopic inspection is a familiar tool in Brush's manufacturing of magnetic heads. Track width and gap alignment must be held to ten-thousandths; pole faces and tips must be lapped to a surface finish of better than 8 microinches.

This craftsmanship improves product performance. Precision gap alignment assures perfect time phase accuracy. Close tolerances permit greater pulse packing, increased storage capacity, uniform output and frequency response.

Get the facts on Brush's complete line of magnetic heads, including the new precision multichannel heads. Write Brush Electronics Company, Dept. K-100, 3405 Perkins Avenue, Cleveland 14, Ohio.

**BRUSH ELECTRONICS**

3405 Perkins Avenue, Cleveland 14, Ohio



**COMPANY**

DIVISION OF

**CLEVITE**  
CORPORATION

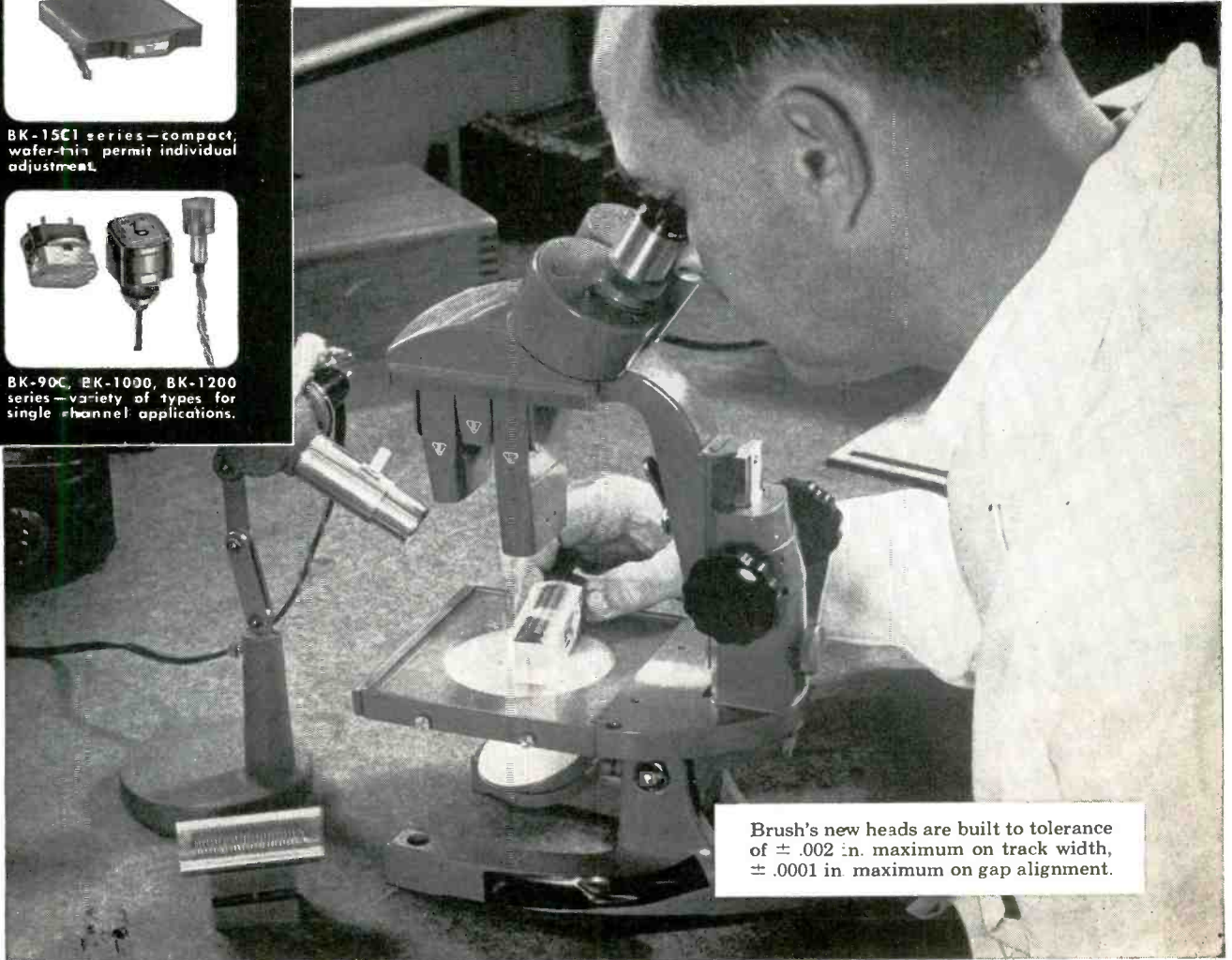

Brush's new heads are built to tolerance of  $\pm .002$  in. maximum on track width,  $\pm .0001$  in. maximum on gap alignment.

# HOW TO SPEED YOUR TESTING

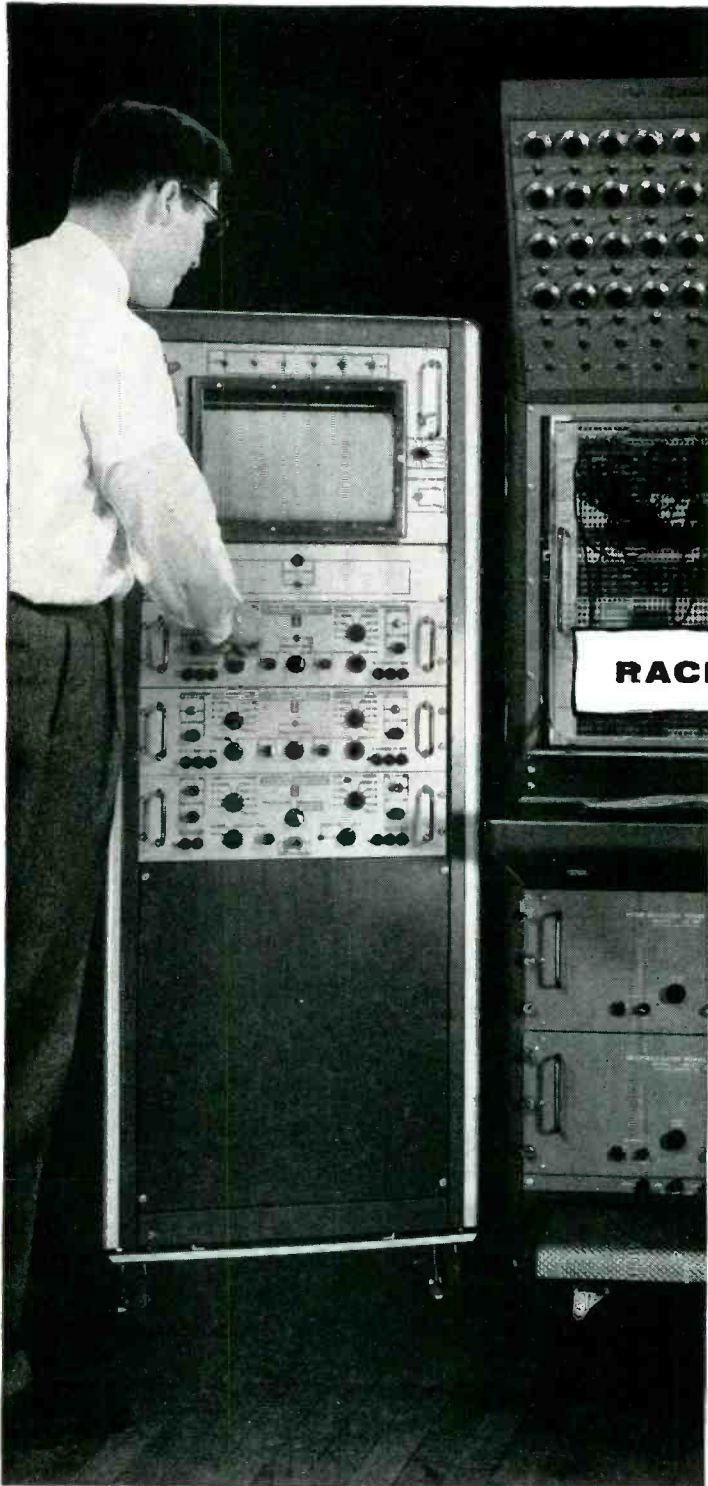

Complete line of  
**BRUSH RECORDING SYSTEMS**  
offers exact  
instrumentation  
you need to record data  
faster...more easily

## RACK-MOUNTED SYSTEMS



Oscillographs and amplifiers fit standard 19-inch racks.  
For 1, 2, 4 or 6-channel systems.

## MOBILE INSTRUMENT CART

Single or dual-channel oscillograph with accompanying amplifiers may be mounted in this mobile instrument cart. "Instrumentation on wheels" saves engineers' time.



# AND DEVELOPMENT

These direct-writing oscillographic systems record variables from d.c. to 100 cycles per second immediately, eliminate the manual labor in data recording.

Only Brush offers all these features:

**WIDE SPEED SELECTION** . . . choice of 8 or 16 chart speeds allows you to select the speed best suited for the variable being measured, assuring optimum readability, accuracy and economy in chart paper.

**EASILY OPERATED** . . . set-up time is at a minimum. Instantaneous switching and remote control streamline operation.

**COMPLETE LINE** . . . Brush Systems are complete. You have a choice of D.C. Amplifiers, amplifiers for use with either resistive or inductive transducers, or high gain amplifiers. Choice of ink or combination ink and electric writing oscillographs.

**GET THE FACTS** . . . Ask your Brush Representative for complete specifications, or write Brush Electronics Company, Department K-10, 3405 Perkins Avenue, Cleveland 14, Ohio.

## PORTABLE SYSTEMS

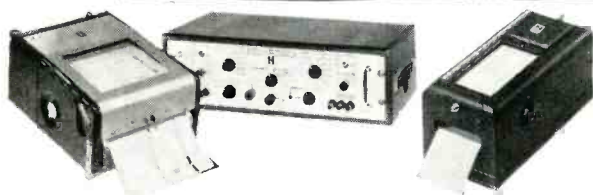

Portable oscillographs and amplifiers are light in weight, easy to set up on the job. Four channel oscillograph weighs 38 pounds, 6-channel unit 51 pounds.

### IDEAL FOR FIELD USE

Portable units are rugged, designed to stand up under tough field testing conditions, yet perform with laboratory accuracy. Brush equipment is ideal for instrumentation set-up in station wagon, trailer, etc.



**BRUSH ELECTRONICS**

3405 Perkins Avenue, Cleveland 14, Ohio



**COMPANY**

DIVISION OF

**CLEVITE**  
CORPORATION

*another* **FIRST** *for* **KOVAR!**<sup>®</sup>  
**(The Glass Sealing Alloy)**

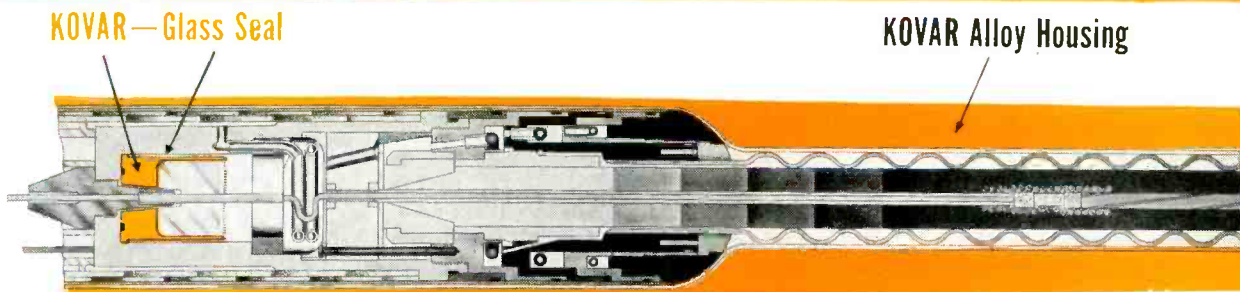

*Submarine Cable Repeater Courtesy of Western Electric Co.*

**in the new**  
**TRANS-ATLANTIC TELEPHONE CABLE**

In the development of this project, one of the engineering problems was to design, build and test a series of electronic tubes of the amplifying type to meet severe conditions never previously encountered. Not only would the repeater unit be subjected to several tons pressure, but it must have a minimum life of 20 years.

The project is now nearing reality and the undersea repeaters developed by Bell Laboratories and manufactured by Western Electric will soon have a vital role as part

of the world's first transoceanic telephone cable. In the precision manufacture of the repeater units, the best obtainable materials were selected—including Kovar Alloy for the interior glass-to-metal seals as well as for the outer housing.

Kovar Alloy has won the confidence of the electron tube industry for the past twenty years—and we invite you to call upon us with your metal-to-glass sealing problems.

®Westinghouse Trade Mark No. 337,962

**STUPAKOFF** DIVISION OF

**The CARBORUNDUM Company**

WRITE DEPT. E LATROBE, PENNSYLVANIA

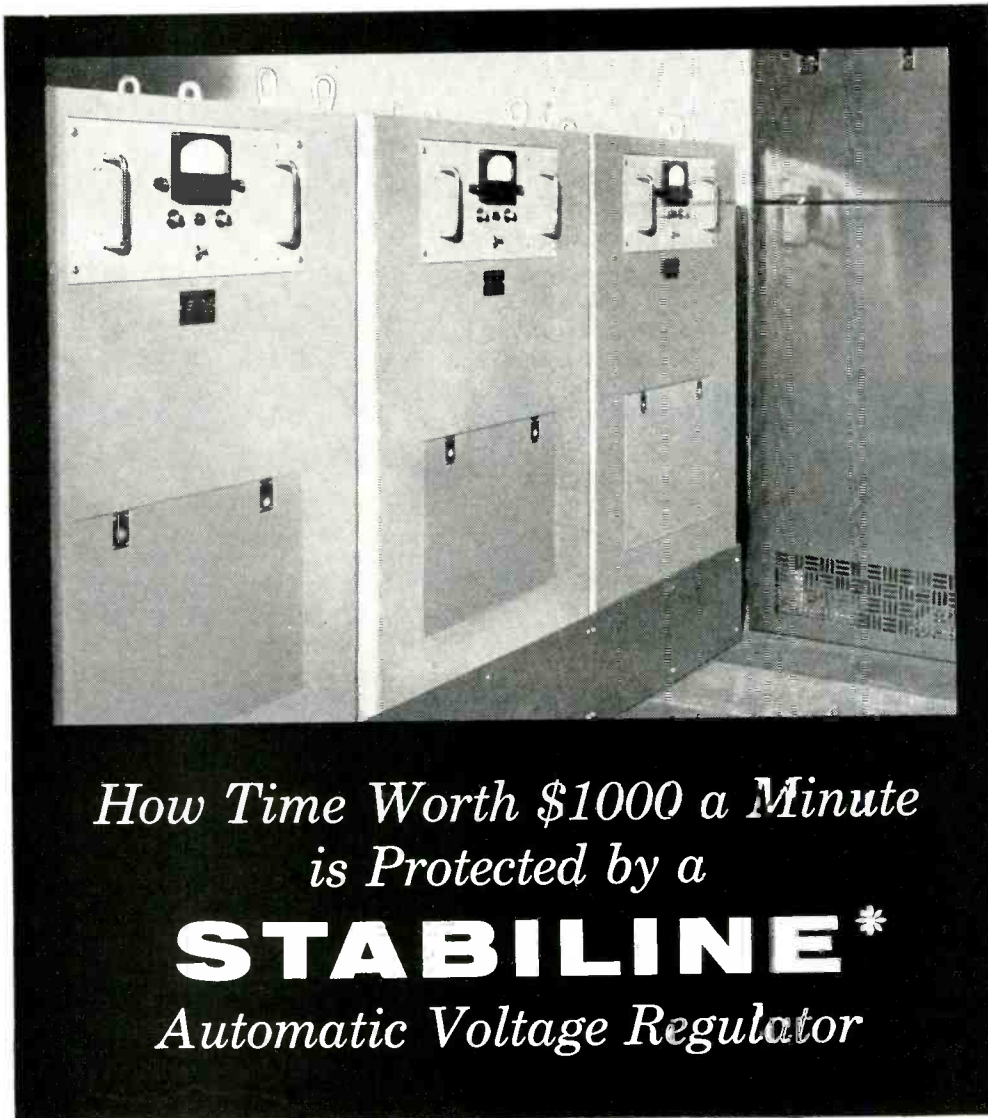

*How Time Worth \$1000 a Minute  
is Protected by a*  
**STABILINE\***  
*Automatic Voltage Regulator*

Station KTTV, Mount Wilson, California, is owned by the Los Angeles Times.



At Television Transmitter Station KTTV a STABILINE Automatic Voltage Regulator has been in continuous operation, with no replacement of parts, for over two years. *By maintaining constant voltage to the transmitter, it has already paid for itself.* Expensive transmitter tubes

require constant voltage for peak performance and long life.

At literally no cost, this STABILINE type EM helps to keep the station on the air by preventing lost time (worth nearly \$1000 a minute) due to tube failure.

Be sure to visit SUPERIOR  
ELECTRIC'S Mobile Display when  
it is in your area

\*Trademark Reg. U. S. Pat. Off.

Branch Offices at: 14663 Titus St., Van Nuys, California • P. O. Box 946, 2881 El Camino Real, Redwood City, California  
482-B Eglinton Ave., West, Toronto 12, Ontario, Canada  
2217 Biscayne Blvd., Miami 37, Florida • P. O. Box 48,  
721 So. Blvd., Oak Park, Illinois • 4033 W. Rogers Ave.,  
Office #2, Tippet Bldg., Baltimore 15, Maryland • 250 Park  
Ave., Rms. 502-504 Postum Bldg., New York 17, New York  
P. O. Box 132, 101 Public Sq., Medina, Ohio • 4515 Prentice  
St., Room 201, Dallas 6, Texas • 839 Central Bldg., 810 Third  
Ave., Seattle 4, Washington.



THE  
**SUPERIOR ELECTRIC**  
COMPANY

210 MIDDLE STREET, BRISTOL, CONNECTICUT

Please send me your STABILINE Bulletin S157.

Name .....

Company .....

Address .....

City ..... Zone ..... State .....

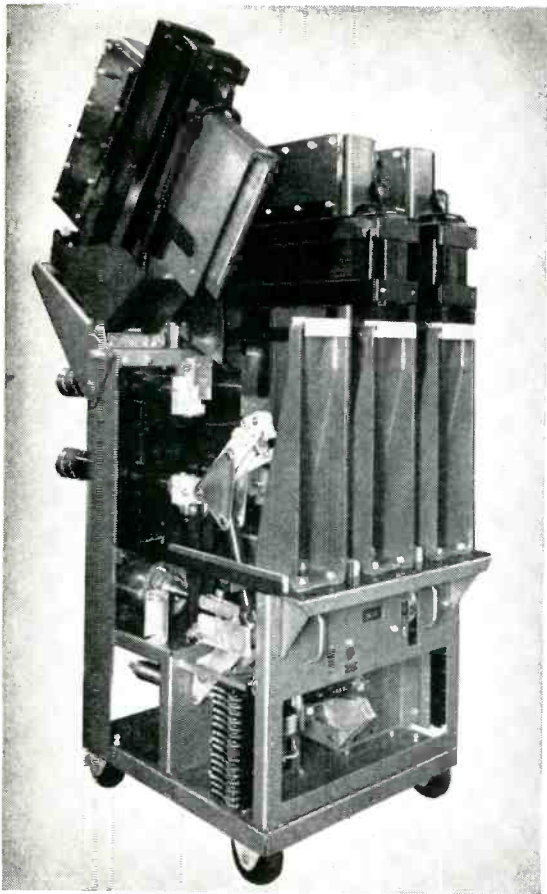

**ROLLED AND MOLDED ARC CHUTE SHELLS**, made by C-D-F for the I-T-E Circuit Breaker Company for 7.5 and 15 KV air magnetic circuit breaker, are good examples of paper-base Dilecto doing a hard job. Each completely closed insulating shell (NEMA grade X) has flame-retardant construction, negligible water absorption, and high dielectric strength at all points to withstand impulse test requirements.

**High strength, low cost...**

## **C-D-F paper-base Dilecto®**

Excellent electrical properties, ease of machining and punching, with low costs are features of the many paper-base grades of Dilecto laminated plastics. Adaptable to forming, Dilecto is a mechanically versatile insulating material that withstands difficult operating conditions, moisture and temperature variations.

Insulating papers include kraft-alpha, cotton rag, and asbestos. Improved phenolic, or melamine silicone laminating resins are used. C-D-F builds flame resistance into a paper-base laminate—you get a worthwhile, easier-to-machine substitute for a glass-base laminate. C-D-F bonds copper uniformly to Dilecto — you get a superior metal-clad laminate for printed circuit applications.

A big, reliable source of supply, C-D-F helps you improve design, simplify purchasing, speed production. Look in C-D-F's catalog in the Product Design File (Sweet's) for the address of your nearest C-D-F sales engineer. Write for samples and new Dilecto catalog:



## **CONTINENTAL DIAMOND FIBRE**

CONTINENTAL-DIAMOND FIBRE DIVISION OF THE BUDD COMPANY, INC.

NEWARK 16, DELAWARE

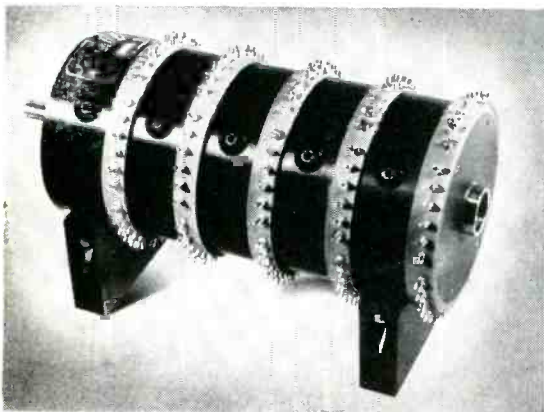

**THIS HIGH-SPEED SAMPLING SWITCH**, for missile telemetering and automation applications has a paper-base Dilecto tubing body. Materials engineers at General Devices, Inc., selected Dilecto "for its mechanical properties and low moisture absorption."

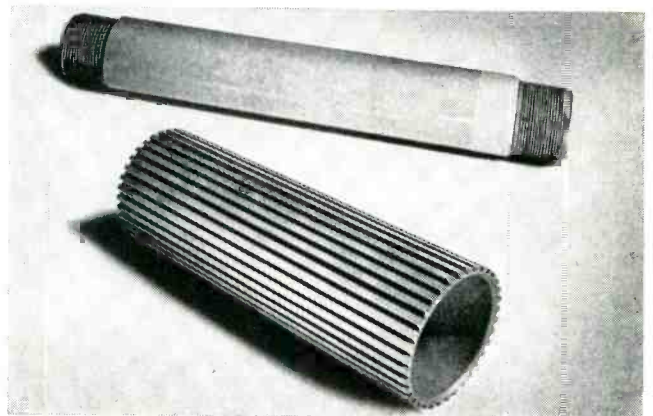

**ACCURATE MACHINING, SMOOTH FINISHING** are two merits of paper-base Dilecto. Note the perfection of milling cuts and threads! C-D-F has mass-production equipment, or can furnish sheets, tubes and rods with cost-cutting machining information.

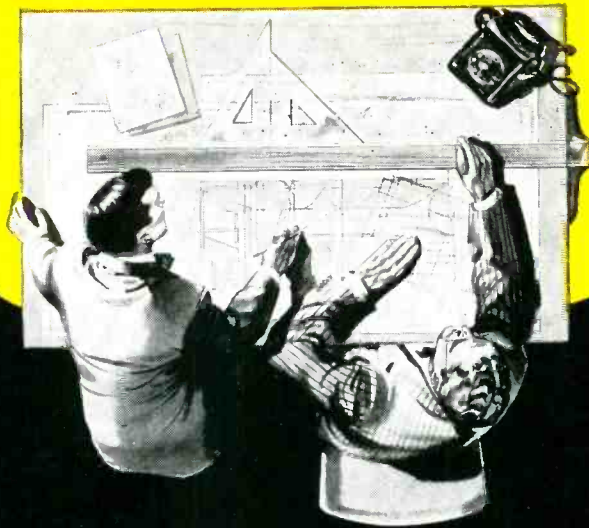

# A new perspective to Springmaking



## Multiple sources for "Things" not called SPRINGS

*Yours to put to work . . . our mechanical ingenuity and craftsmanship . . . experienced in producing an infinite variety of metal parts in such fields as automation, communication, medical, electronics, safety devices, product development, etc. The capacity of ASC springmaking minds and machines is unlimited. Ask any Division to examine your sample or blueprint.*

<b>WALLACE BARNES COMPANY</b> BRISTOL, CONNECTICUT	<b>THE WILLIAM D. GIBSON COMPANY</b> 1800 CLYBOURN AVE. CHICAGO 14.	<b>RAYMOND Manufacturing COMPANY</b> CORRY, PENNSYLVANIA	<b>BARNES-GIBSON - RAYMOND</b> 40300 PLYMOUTH RD. PLYMOUTH, MICH.	<b>B-G-R COOK PLANT</b> ANN ARBOR MICHIGAN
<b>SEABOARD Coil Spring Div.</b> 15001 S. BROADWAY GARDENA, CALIF.	<b>OHIO DIVISION</b> 1825 EAST FIRST ST. DAYTON, OHIO	<b>WALLACE BARNES COMPANY</b> STATE FAIR BLVD. SYRACUSE 91 (Solvay), N.Y.	<b>MILWAUKEE DIVISION</b> 341 E. ERIE ST. MILWAUKEE, WIS.	
<b>DUNBAR BROTHERS COMPANY</b> BRISTOL, CONN.	<b>F. N. MANROSS AND SONS CO.</b> BRISTOL, CONNECTICUT	<b>THE WALLACE BARNES CO., LTD.</b> HAMILTON CANADA		

*Divisions of*

**ASSOCIATED SPRING CORPORATION**

# How to make a Magnetic Core that's really SMALL?

use **AL**

**PERMENDUR**

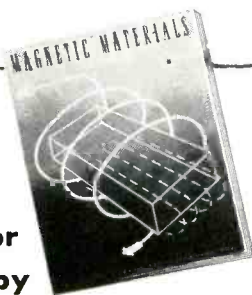

Write for  
your copy

**"MAGNETIC MATERIALS"**

This 32-page book contains valuable data on all Allegheny Ludlum magnetic materials, silicon steels and special electrical alloys. Illustrated in full color, includes essential information on properties, characteristics, applications, etc. Your copy gladly sent free on request.

ADDRESS DEPT. E-82

When the conditions of service make it imperative for you to hold the size and weight of magnetic cores at an absolute minimum, that's the place to use Permendur. With it you can push the flux density up to 20 kilogausses, and practically eliminate weight as a consideration.

Along with its suitability for cores wherever the premium is laid on compactness, Permendur is just the thing for sonar magnetostriction applications, too. We maintain proper annealing facilities for this

alloy. Write for technical data on it, and let our engineers help you to cash in on its possibilities.

In addition to Permendur, we offer a range of high-permeability alloys, oriented silicon steels and other electrical alloys that is unmatched in its completeness. Our services also include the most modern facilities for lamination fabrication and heat treatment.

Let us supply your requirements. *Allegheny Ludlum Steel Corporation, Oliver Building, Pittsburgh 22, Pa.*

**STEELMAKERS** to the Electrical Industry

**Allegheny Ludlum**

WSW 6119





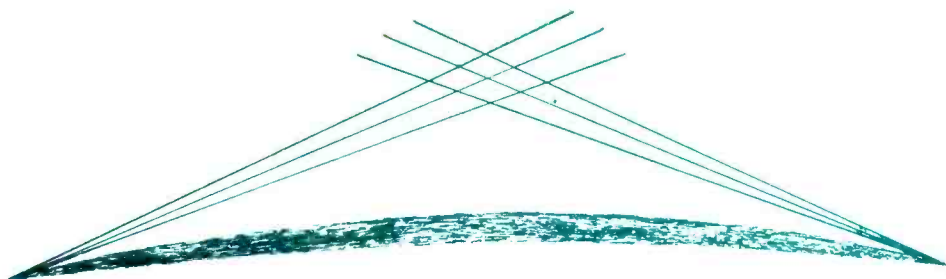

## TOP NAME IN TROPO SCATTER

World leadership in the design and manufacture of radio equipment for tropospheric scatter systems is established by the selection of REL equipment for these major projects:

**THE FIRST: POLEVAULT**  
**THE LARGEST: WHITE ALICE**  
**THE NEWEST: AN/FRC-39**

REL's patented Serrasoid® modulator has a six-year record of unequalled reliability and transmission quality.

Combiner receivers incorporate unique REL circuits, and exploit to the maximum the possibilities for diversity advantage in scatter signalling.

The Serrasoid®, the combiner, and other special circuit features enable REL to produce systems with toll quality transmission of up to 150 telephone channels.

More kilowatt miles of Tropo equipment by REL is in use and in production than that of all other companies combined.



**Radio Engineering  
Laboratories - Inc.**

36-40 37th St • Long Island City 1, N. Y.

STillwell 6-2100 • Teletype: NY 4-2816

Canadian Representative:

Alcorn & Soper Co., P. O. Box 715, Ottawa

*Creative careers at REL await a few exceptional engineers.  
Address resumes to James W. Kelly, Personnel Director.*

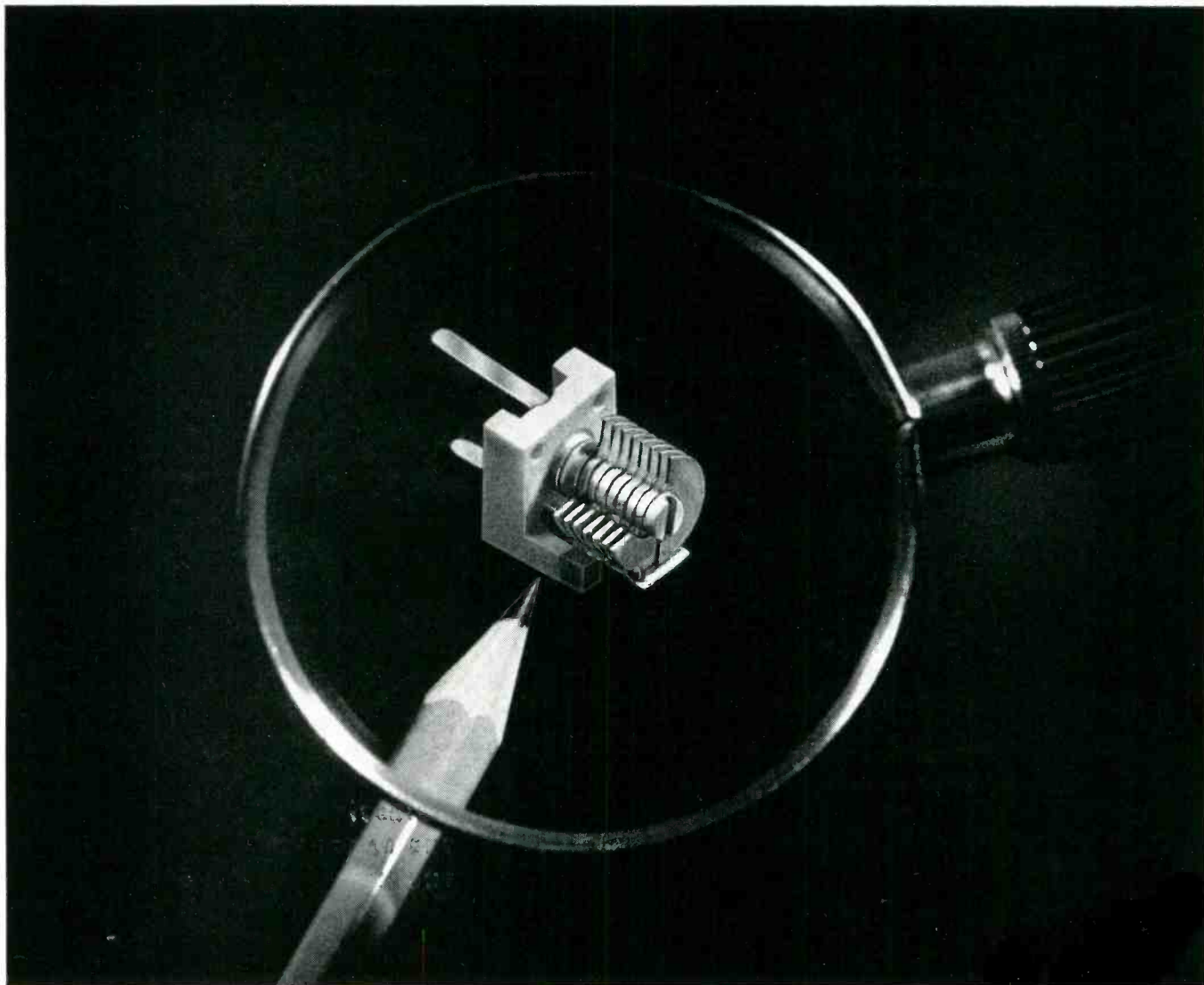

More than  $1\frac{1}{2}$  times actual size.

## NOW! even smaller air trimmer capacitors

For every type of electronic equipment—printed wiring board or conventional chassis—Radio Condenser's new Series 75 trimmers mean more circuit in less space. Measuring just  $25/64"$  x  $7/16"$  x  $17/32"$  behind mounting surface, they're the tiniest trimmers ever made in the United States.

Three capacitance ranges are available, as tabulated below. Each is equipped with plug-in tabs for printed wiring board insertion, as well as two holes for conventional screw mounting. The sturdy low loss ceramic body, brass plates soldered and silver plated, assure a rugged unit, able to take extreme shock, vibration and temperature change. Capacitance is easily varied by means of a screwdriver slot in the rotor shaft.

Insulation resistance, "Q" and thermal stability characteristics are excellent.

Complete Engineering data and specifications for the new Series 75 Subminiature Trimmer capacitors are provided in Bulletin TR-123, available free on request. Write Radio Condenser now for your copy.

RADIO CONDENSER  
MINIATURE AIR TRIMMER CAPACITORS

Type No.	Min. Cap. $\mu\mu\text{F}$	Effective Max. Cap. $\mu\mu\text{F}$	Air Gap	No. Plates
875001	1.2	5	.014	9
875002	1.2	10	.008	11
875003	1.5	15	.008	15



## RADIO CONDENSER CO.

Davis & Copewood Streets • Camden 3, New Jersey  
 EXPORT: Radio Condenser Co., International Div., 15 Moore St., N.Y. 4, N.Y.  
 CABLE: MINTHORNE  
 CANADA: Radio Condenser Co. Ltd., 6 Bermondsey Rd., Toronto, Ontario

**GOOD AND STRAIGHT—won't whip!**

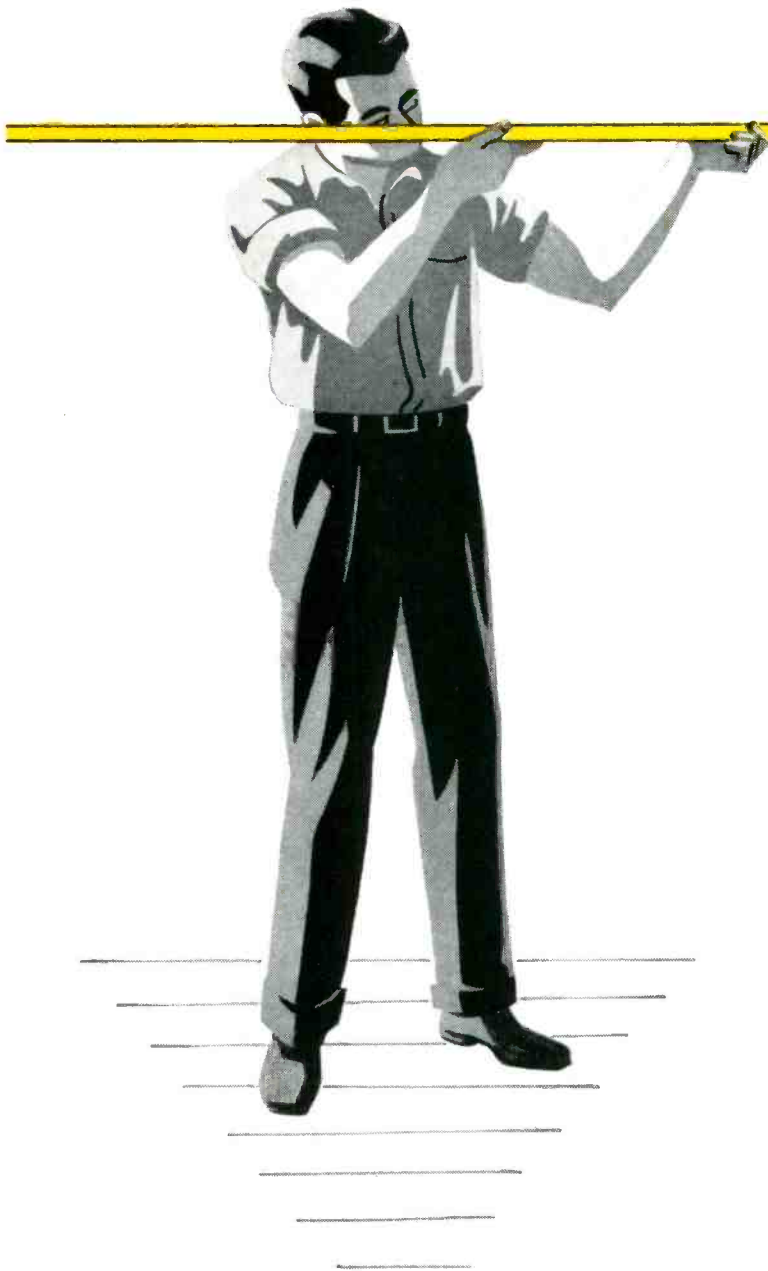

**CHASE<sup>®</sup>**  
**free-cutting**  
**BRASS**

**ROD • BAR • SHAPES**

Screw machines really purr along when you feed them Chase Free-Cutting Brass rod! Uniform lengths and straight lengths that won't whip, superior machinability, longer runs before regrinding tools, all mean more pieces per length, fewer rejects and less down time per machine. Order from your Chase warehouse!

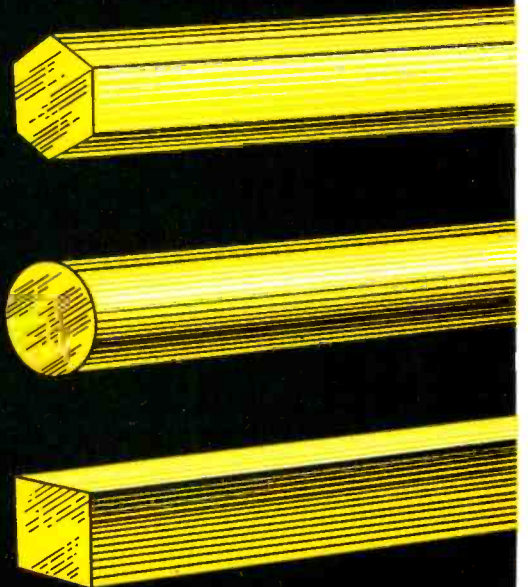

**Chase** 

**BRASS & COPPER CO.**

WATERBURY 20, CONNECTICUT • SUBSIDIARY OF KENNECOTT COPPER CORPORATION

*The Nation's Headquarters for Brass, Copper and Stainless Steel*

Atlanta Baltimore Boston Charlotte Chicago Cincinnati Cleveland Dallas Denver Detroit Grand Rapids Houston Indianapolis Kansas City, Mo. Los Angeles Milwaukee Minneapolis Newark New Orleans New York Philadelphia Pittsburgh Providence Rochester St. Louis San Francisco Seattle Waterbury

# 20 KW medium or high frequency

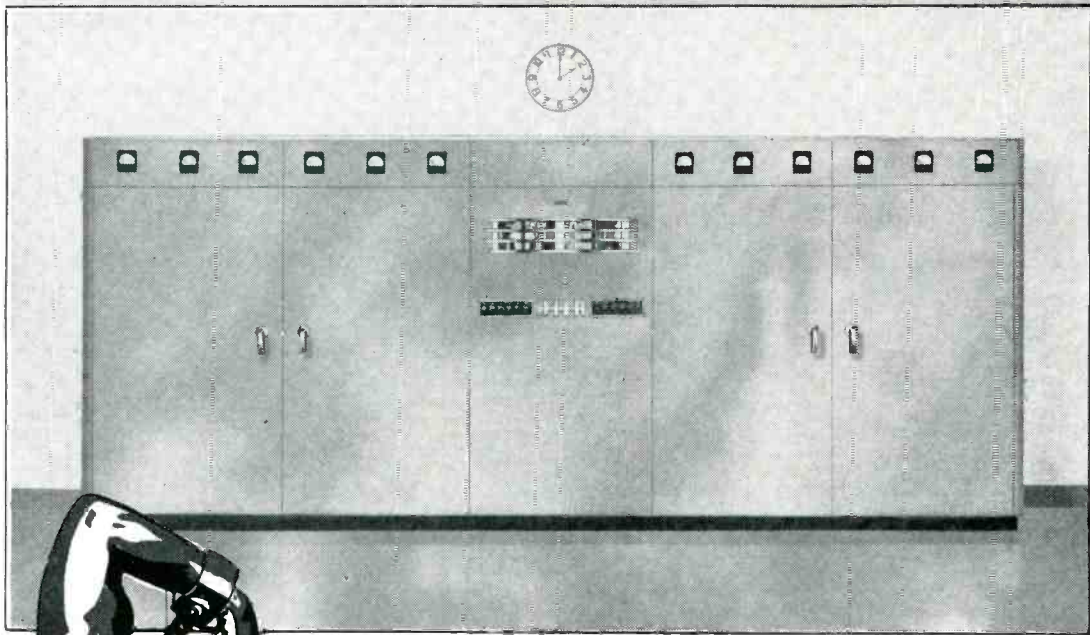

a world of power

Full 20KW output available in four models: (1) medium frequency 540-1600 Kc broadcast; (2) short wave broadcast; (3) high frequency telephone and telegraph; (4) high frequency telegraph. Built to exacting, around-the-clock commercial requirements, this series of 20KW transmitters is already serving in some of the world's toughest climates for both intercontinental and broadcast service. Fully described on Pages 4-10 in Gates catalog No. 59, supplied on request.

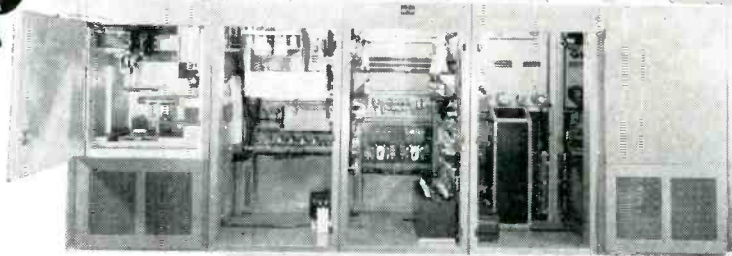

Ease of servicing is mighty important to engineers responsible for world-wide communication. Gates walk-in design is one big reason why, in the important places, Gates high power transmitters predominate.

**GATES RADIO COMPANY** • *Manufacturing Engineers Since 1922* • Quincy, Illinois, U. S. A

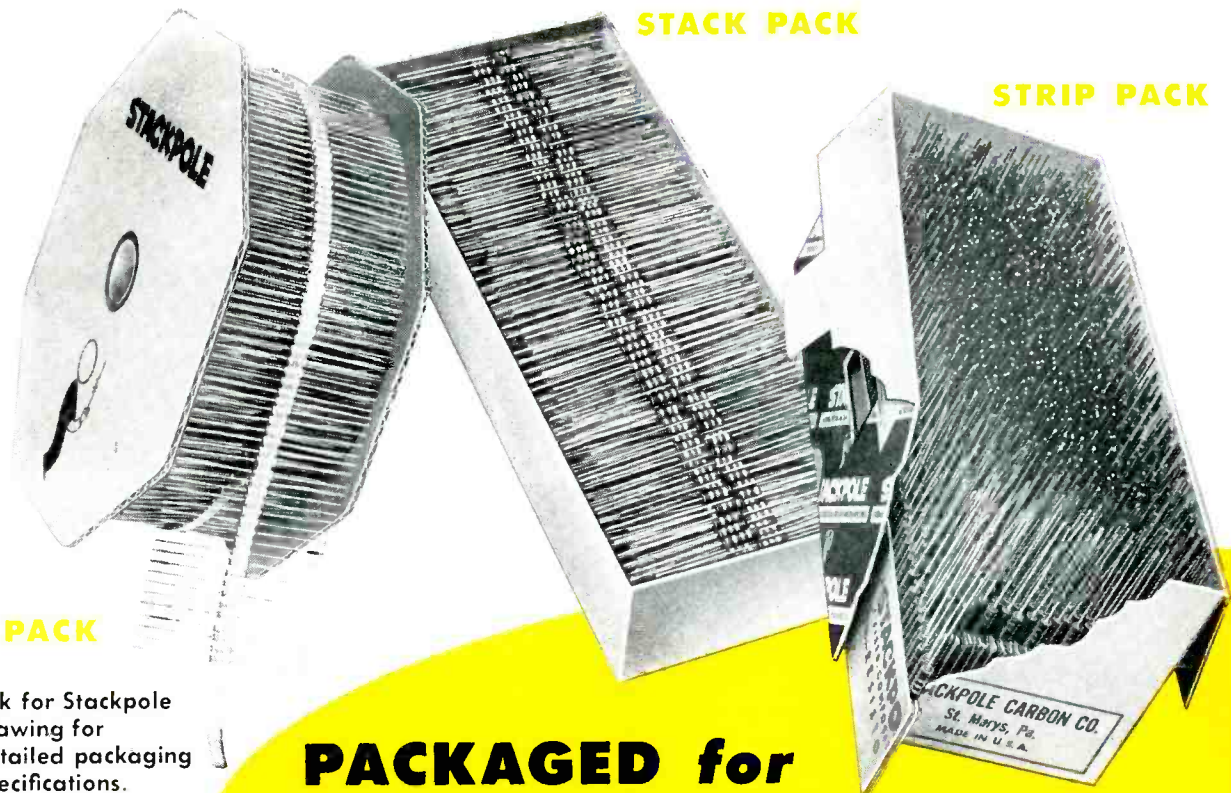

**REEL PACK**

Ask for Stackpole drawing for detailed packaging specifications.

**STACK PACK**

**STRIP PACK**

**PACKAGED for PRODUCTION EFFICIENCY**

*Conservatively rated at 70°C.*

*on your assembly lines*

*Low noise level.*

**FIXED COMPOSITION**

**STACKPOLE RESISTORS**

*Unsurpassed humidity protection.*

*Easy-to-solder, firmly anchored leads.*

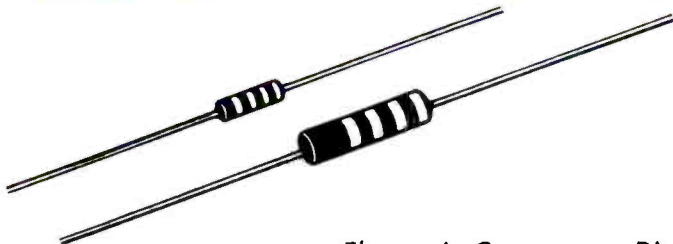

Electronic Components Division  
**STACKPOLE CARBON COMPANY • St. Marys, Pa.**

Stackpole Fixed Composition Resistors are stocked by leading parts distributors

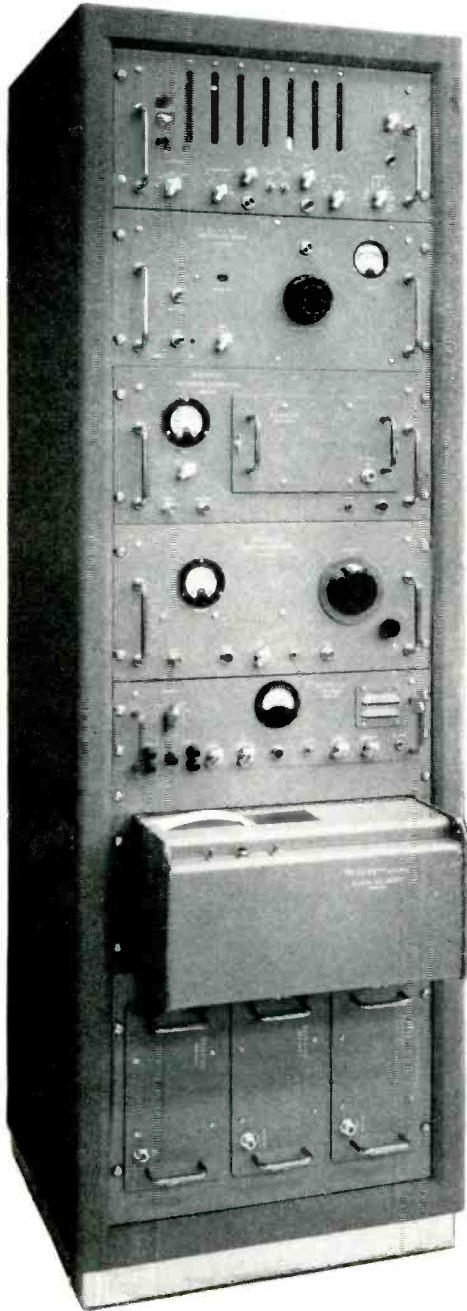

Typical automatic frequency measurement and logging system showing (top to bottom) Model 5571 Frequency Meter, Model 5580 Reference Generator with Model 5581 Plug-in, Model 5585 Selective Amplifier, Model 5590 WWV Receiver, and Model 1452 Digital Recorder.

Why not get the facts? Write now for new Berkeley Frequency Measuring Equipment bulletin; please address Dept. G-10.

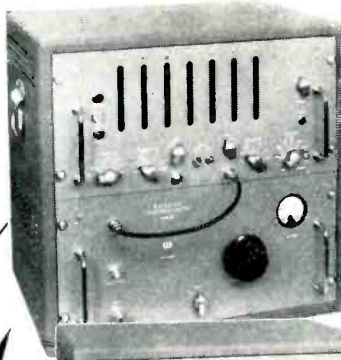

Model 5571 0-42 mc Frequency Meter; price, \$1,745.00



Model 5580 Reference Generator, with 5581 series plug-ins, extends range to 515 mc. Price, Model 5580, \$300.00; 5581/4 plug-in (42-155 mc) \$150.00; 5581/15 thru 48 (152 to 515 mc in 33 mc bands), \$100.00 each.

## The Frequency Meter That Grows With The Job Berkeley Model 5571

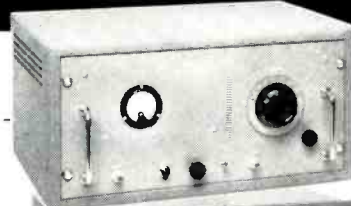

Model 5585 Selective Amplifier provides 100 microvolt sensitivity in the 0-42 mc range. Price, \$425.00



Model 5590 WWV receiver permits calibration of 5571 within  $\pm 2$  parts in  $10^5$ , for use as secondary frequency and time standard. Price, \$495.00



Model 1452 Digital Recorder automatically prints readings on standard adding machine tape. Price, (6-digit), \$850.00

Note: All prices f.o.b. factory, subject to change without notice.

### FLEXIBILITY...

here's the **one** frequency meter that won't be out-dated as your requirements grow or change. By adding matched accessory units, you can extend its range to 515 mc, add a WWV receiver for calibration within  $\pm 2$  parts in  $10^5$ , or a digital recorder to print measured frequency automatically on standard adding machine tape.

### VERSATILITY...

functions as a frequency ratio meter, 0-1 mc period meter,  $1 \mu\text{sec}$  to 10,000,000 sec time interval meter, or 0-2 mc EPUT\* meter as well as a 0-42 mc frequency meter.

\*Trademark

# Berkeley

division

BECKMAN INSTRUMENTS INC.

Phone: Landscape 6-7730 • Richmond 3, California



To meet the increasing demand for miniaturization, Fairchild's line of sine-cosine potentiometers has been expanded and now includes 3", 2" and 1½" diameter sizes. Development of these sizes resulted from Fairchild's continuous and extensive research to provide users with the practical balance between size and functional conformity to best meet their individual needs. As an example, an entirely new winding technique has been developed by Fairchild which assures greater accuracy and reliability with longer life.

## SINE-COSINE POTENTIOMETERS

### What size do you need?

These new all-metal-case sine-cosine potentiometers are easily gangable and available in three sizes.

The 3" diameter (Type 753) has a resistance range up to 45K ohms per quadrant and a functional conformity of  $\pm 0.35\%$  measured peak-to-peak. The 2" unit (Type 754) has a resistance range of 300 to 25K ohms and  $\pm 0.65\%$  functional conformity. The miniature 1½" diameter (Type 741) has a resistance range up to 12K ohms per quadrant and a functional conformity of  $\pm 1\%$ . Conformity values as low as 0.25%, 0.50% and 0.75% are available under special conditions in Types 753, 754 and 741 respectively.

The exclusive new winding technique, eliminating wire changes and tapping or shunting, provides longer life and greater accuracies than previously obtainable.

No matter what factors govern your choice of precision potentiometers, you'll find the answer in Fairchild's complete line. Write Dept. 140-71A, Fairchild Controls Corporation, Components Division, 225 Park Avenue, Hicksville, Long Island, New York.

**EAST COAST**  
225 Park Avenue  
Hicksville, L. I., N. Y.

**WEST COAST**  
6111 E. Washington Blvd.  
Los Angeles, Cal.

**FAIRCHILD**  
**PRECISION POTENTIOMETERS**  
**and COMPONENTS**

MALLORY



*By changing materials, simplifying machining on this voltage regulator contact, Mallory engineers cut costs 25%.*

## Value Analysis by Mallory Saves Money on Contacts

### Mallory Contact Engineering Offers Five Ways To Improve Economy

1. **The most effective contact material** from the extensive line developed by Mallory. More economical alloys often can satisfy actual service conditions.
2. **The most economical contact design** . . . for your purchasing, production and product needs.
3. **The most economical backing material** . . . from a group of Mallory alloys developed for this use.
4. **The most economical backing member design** in relation to contact and product design requirements.
5. **The most economical method of assembly** of contact and backing member.

By coordinating *all* these important elements of contact design, Mallory can help you put into effect a long-range plan for cutting contact cost and assuring peak performance.

**B**BETTER not take electrical contacts for granted. There's much more to contact design than meets the eye. Often Mallory engineers can, through a detailed analysis of requirements, recommend changes that amount to real savings.

The contact shown here, for a substation transformer voltage regulator, illustrates how deeply Mallory engineering penetrates into contact design. First step after scrutinizing all aspects of the application, was to change the material to Mallory ELKALOY® A. *This change gave a more economical alloy to work with . . . at no sacrifice of performance for the intended use.* Then, Mallory specialists recommended simplifications in manufacturing. Instead of a double disc finishing operation, they used a rolled-finish product . . . with less waste, less cost. Also eliminated as unnecessary to the desired service were three complete operations: sanding of the entire edge of the piece, and counterboring of holes for hold-down bolts and buffing of the chamfered end.

The contact is now being manufactured under simplified specifications, free of unnecessary "frills"—and gives equal performance *at 25% less cost!*

This is the kind of thorough, cost-conscious engineering that Mallory can apply to your own electrical contact designs. Our extensive experience in contact alloys, contact design and contact assembly engineering is ready to serve you. Write or call Mallory for a consultation.

**Expect more . . . get more from**

P. R. MALLORY & CO. Inc.  
**MALLORY**

P. R. MALLORY & CO., Inc., INDIANAPOLIS 6, INDIANA

#### Serving Industry with These Products:

Electromechanical—Resistors • Switches • Tuning Devices • Vibrators  
Electrochemical—Capacitors • Rectifiers • Mercury Batteries  
Metallurgical—Contacts • Special Metals • Welding Materials



# 7-inch Waldes Truarc retaining rings cut costs, speed assembly-disassembly of 2-high/4-high mill

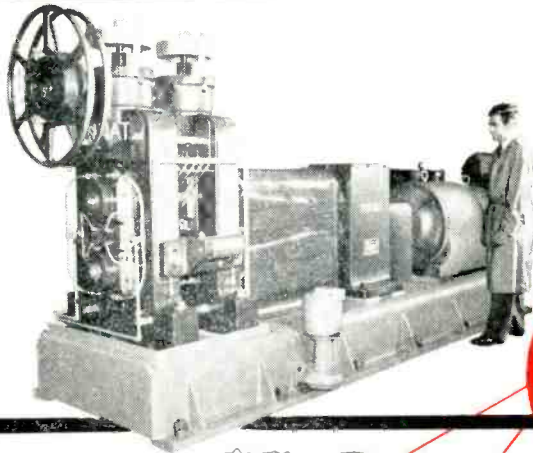

New Model TA-625 2-high/4-high combination rolling mill designed by Stanat Manufacturing Co., Long Island City, N. Y., reduces 2½" ingot to precision-rolled strip as thin as .001".

Waldes Truarc retaining rings help make possible a complete change of work rolls in 20 minutes...solve difficult problems of accuracy control by achieving positive location of bearings to extremely close tolerances. Rings eliminate costly parts and machining, save space, reduce maintenance.

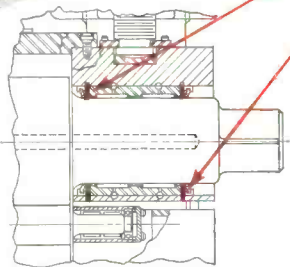

In the assembly illustrated above, 7" Waldes Truarc (Series 5000) retaining rings—three on each roller—are used to position heavy-duty needle bearings in the bearing housing. Smaller rings position bearings in other roller assemblies and retain the shaft of a dual handwheel screwdown. All in all, 18 Waldes Truarc rings are used in the mill. They replace machined shoulders, spacers and lock nuts...eliminate costly threading, other machining operations.

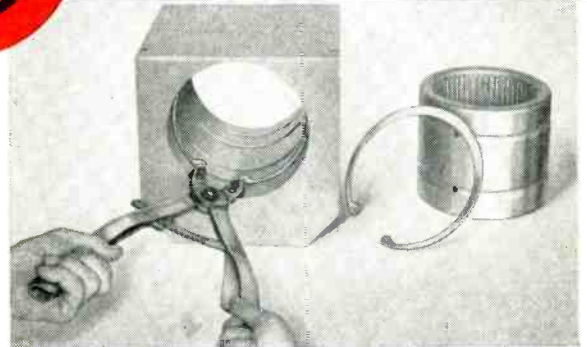

Assembly is simple, even with giant 7" diameter Truarc ring. Special Truarc ratchet pliers grasp the ring securely, ease it into the groove, snap it securely into position. Smaller pliers and various high-speed assembly jigs are available for other rings, permit assembly-disassembly to be performed rapidly even by unskilled labor.

**Whatever you make**, there's a Waldes Truarc Retaining Ring designed to improve your product... to save you material, machining and labor costs. Quick and easy to assemble and disassemble, they do a better job of holding parts together. Truarc rings are precision-engineered and precision-made, quality controlled from raw material to finished ring.

**36 functionally different types**... as many as 97 differ-

ent sizes within a type... 5 metal specifications and 14 different finishes. Truarc rings are available from 90 stocking points throughout the U.S.A. and Canada.

**More than 30** engineering-minded factory representatives and 700 field men are available to you on call. Send us your blueprints today... let our Truarc engineers help you solve design, assembly and production problems... without obligation.

For precision internal grooving and undercutting... Waldes Truarc Grooving Tool!

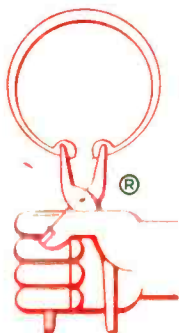

**WALDES**  
**TRUARC**<sup>®</sup>  
**RETAINING RINGS**

© 1956 Waldes Kohinoor, Inc., 47-16 Austel Place, L. I. C. 1, N. Y.

Waldes Kohinoor, Inc., 47-16 Austel Place, L. I. C. 1, N. Y.  
Please send the new supplement No. 1 which brings Truarc Catalog RR 9-52 up to date.  
(Please print)

Name .....

Title .....

Company .....

Business Address .....

City ..... Zone ..... State .....

E 108

WALDES TRUARC Retaining Rings, Grooving Tools, Pliers, Applicators and Dispensers are protected by one or more of the following U. S. Patents: 2,382,948; 2,411,426; 2,411,761; 2,416,852; 2,420,921; 2,428,341; 2,439,785; 2,441,846; 2,455,165; 2,483,379; 2,483,380; 2,483,383; 2,487,802; 2,487,803; 2,491,306; 2,491,310; 2,509,081; 2,544,631; 2,546,616; 2,547,263; 2,558,704; 2,574,034; 2,577,319; 2,595,787, and other U. S. Patents pending. Equal patent protection established in foreign countries.

# New trends and developments in designing electrical products . . .

## How to magnetize permanent magnets to obtain maximum energy product and magnetic stability

According to the domain theory of ferromagnetism, a magnetic material is composed of elementary magnetic volumes called domains. These domains are randomly oriented in unmagnetized materials (Figure 1). Their fields cancel each other, and no external field results.

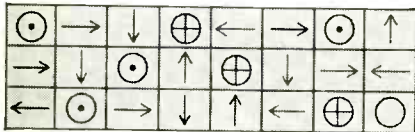

Figure 1—Demagnetized material (domains completely disorganized)

Subjecting the magnetic material to an external field rotates the elementary magnets in the direction of the applied field (Figure 2). In permanent magnets, this orientation is retained to some extent after the field is removed. The magnetic material exhibits poles and an external field.



Figure 2—Magnetized material (domains rotated into alignment)

The improvement of permanent-magnet materials has made the elementary domains more difficult to align. Proper magnetization techniques have thus become highly important because of the adverse results of partially magnetized magnets.

Partial magnetization means that the full external field capabilities of the magnet are not realized. And, the magnet is less resistant to demagnetizing influences—hence less stable.

Consequently, General Electric has done extensive work with users of permanent magnets on the problems of effective magnetization.

Modern magnetizing equipment takes advantage of the fact that magnetization is essentially an instantaneous process, and may be achieved with short-duration current impulses. Consequently, direct-current equipment, like generators and electromagnets, are giving way to impulse equipment.

The main advantages of impulse-type magnetizers are lower equip-

ment cost, reduced demand on power supply, and greater flexibility in shapes of fields that can be set up. Impulse equipment generally falls into two basic types:

(1) Half-cycle type, operating from A.C. line (Figure 3). Here, an ignitron tube with suitable control allows current to flow for one-half cycle.

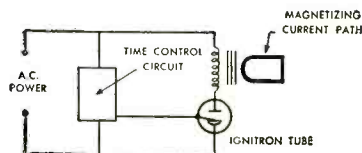

Figure 3—Circuit for half-cycle-type magnetizer

(2) Energy-storage type (Figure 4). Here, a capacitor is charged at a relatively slow rate, and then discharged into the magnetizing circuit. This type of equipment is extremely versatile; tremendous peak currents are possible from low-capacity power systems.

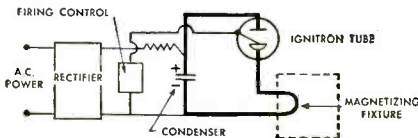

Figure 4—Circuit for energy-storage-type magnetizer

Using this equipment, a simple magnet shape like the "C" magnet in Figure 5 can be magnetized by a single conductor threading the magnet.

Figure 5—Conductor arrangement for "C" magnet



The "E" shape configuration (Figure 6) uses two conductors arranged to carry current in opposite directions to achieve correct polarity.

Figure 6—Conductor arrangement for "E" magnet



Multi-pole magnets (Figure 7) require alternate conductors carrying current in opposite directions to establish simultaneous magnetization of all poles.



Figure 7—Conductor arrangement for multi-pole magnet

One of the more recent developments in magnet configurations—the "bowl" magnet—can be magnetized radially by the conductor arrangement in Figure 8.



Figure 8—Conductor arrangement for "bowl" magnet

These examples give some idea of the variety of magnetizing problems encountered by users of permanent magnets. Each configuration represents a distinct engineering problem in which such variables as conductor size, conductor arrangement, peak current, and current duration must be accurately balanced.

General Electric magnet engineers have at their fingertips all the knowledge and techniques requisite for efficient magnetization. They are always ready to assist designers and users of permanent magnets in getting maximum-energy product and stability.

For more information on G-E Alnico magnets, or assistance on any phase of your magnet design problem, write *Metallurgical Products Department of General Electric Company, 11137 E. 8 Mile Ave., Detroit 32, Michigan.*

*Progress Is Our Most Important Product*

**GENERAL  ELECTRIC**



NEW WESTINGHOUSE  
HIGH-POWER  
SILICON RECTIFIER



*475 amperes d-c . . .  
300 volts PIV*

Highest power silicon rectifying cell commercially available . . . that's the Westinghouse WN-5082!

Ambient temperatures present no heat problems for these silicon cells—units operate in temperatures up to 175° C. Curve below shows forced air-cooled, three-phase bridge ratings.

This diode is ideally suited for railway, elevator, arc welder, battery charger and other industrial high-power applications.

Production quantities are available immediately. For more information on the WN-5082, or any other silicon rectifier requirements, regardless of voltage and current, call your nearest Westinghouse apparatus sales office. Or write Westinghouse Electric Corporation, 3 Gateway Center, P. O. Box 868, Pittsburgh 30, Pennsylvania.

J-09004

**WATCH WESTINGHOUSE!**  
WHERE **BIG** THINGS ARE HAPPENING TODAY!

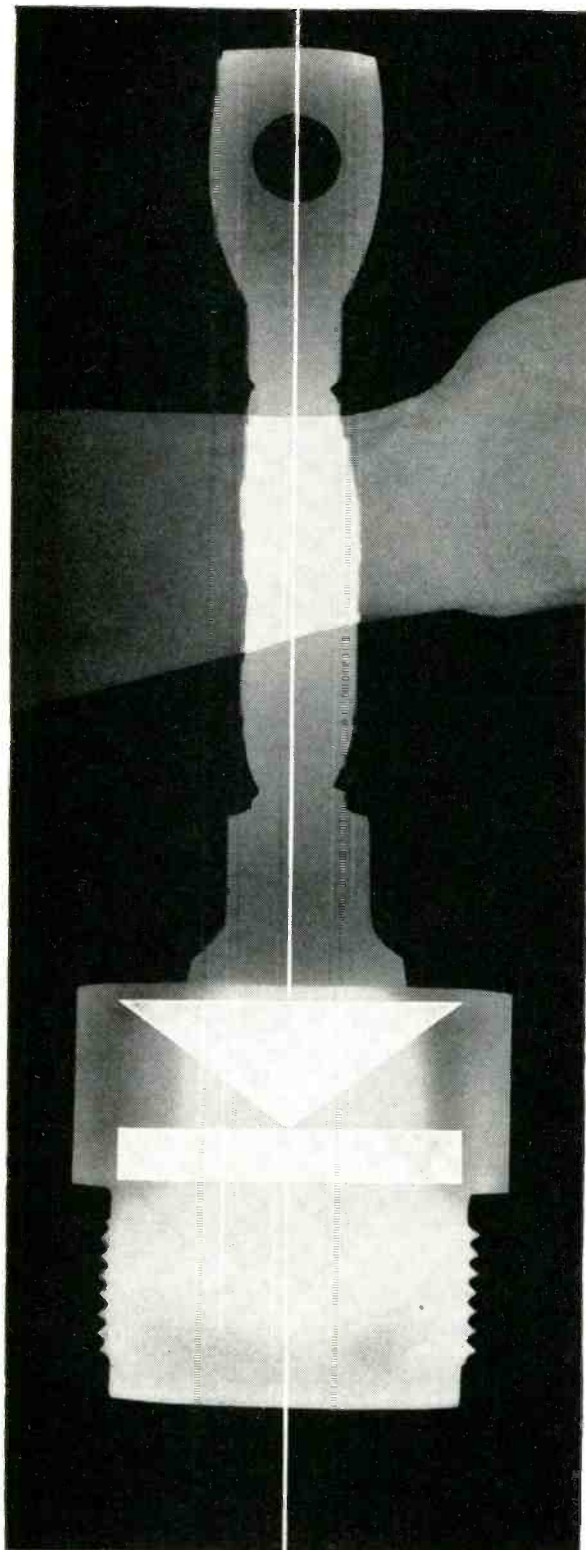

WN-5082 CELLS  
ON 5" x 5" x 1/4" ALUMINUM PLATES  
3-PHASE BRIDGE

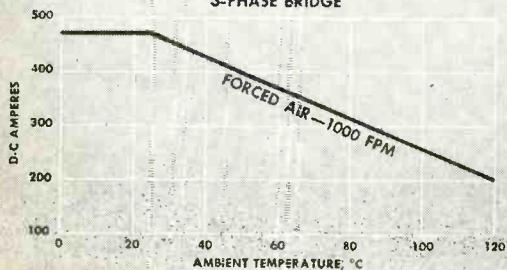

**Electro-Snap Switches Can Be Adapted to Almost Any Job — Quickly, Easily, Economically**

Just choose the Electro-Snap Basic Switch that meets your electrical requirements, add the proper actuator — and presto! — you have a tailor-made precision switch that exactly fits your application. Electro-Snap makes a wide variety of stock actuators to fit almost any requirement. And our engineering department is at your service if a standard combination "won't fill the bill."

For prompt action on your switching problems, send us a brief description and rough sketch of the switch you need.

# Switching Problem?

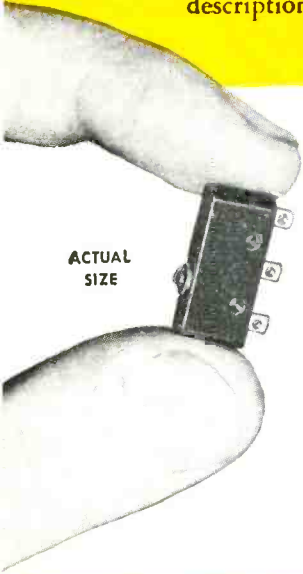

ACTUAL SIZE

**SUB-MINIATURE SWITCHES  
TYPE E-4**

S.P.D.T., 1 circuit; 5 amps, 125/250 v. AC  
Operating force 150 grams max.  
Exceptionally vibration-resistant.  
Special model E4-7 is stabilized for — 65° to + 350° F. operation.

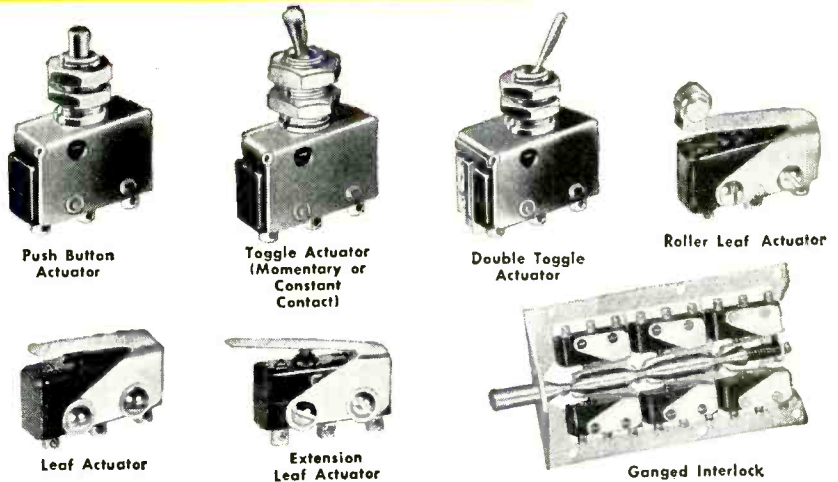

Push Button Actuator

Toggle Actuator (Momentary or Constant Contact)

Double Toggle Actuator

Roller Leaf Actuator

Leaf Actuator

Extension Leaf Actuator

Ganged Interlock

**TYPE S SWITCHES  
Series S1**

S.P.D.T., 2 circuit; 10 amps, 125/250 v. AC/ 30 v. DC. Ind. Screw or solder terminals on ends or one side of switch. Also available with reset button at bottom of switch or in Type S-100 Make-Before-Break Series where switch completes a new circuit before interrupting old one.

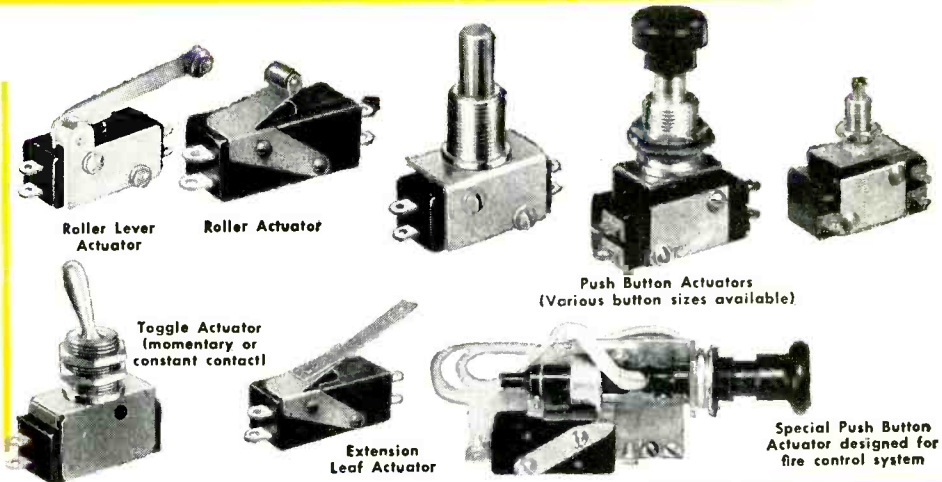
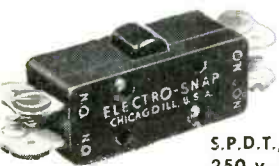

Roller Lever Actuator

Roller Actuator

Push Button Actuators (Various button sizes available)

Toggle Actuator (Momentary or constant contact)

Extension Leaf Actuator

Special Push Button Actuator designed for fire control system

**DOUBLE-POLE SIMULTANEOUS ACTION  
TYPE D-8**

D.P.D.T., 4 Circuit  
15 amps, 125/250 v. AC.  
10 amps, 30 v. DC Ind.  
Eight terminals and four separate circuits which operate simultaneously permit switch to reverse 3-phase motors, replace expensive relays, etc.

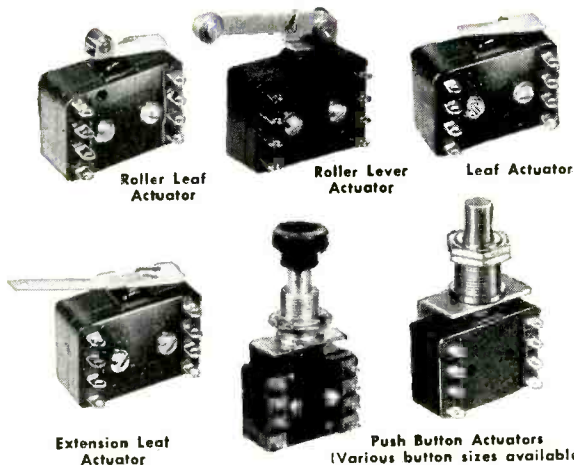

Roller Leaf Actuator

Roller Lever Actuator

Leaf Actuator

Extension Leaf Actuator

Push Button Actuators (Various button sizes available)

**HERMETICALLY-SEALED DOUBLE-POLE SWITCH**

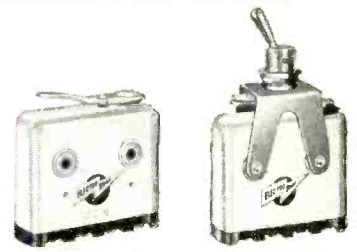

Type J2-4

Toggle Actuator for J2-4

D.P.D.T., 4 circuit 10 amps, 125/250 v. AC/30 v. DC.



# GIANT'S GROWTH

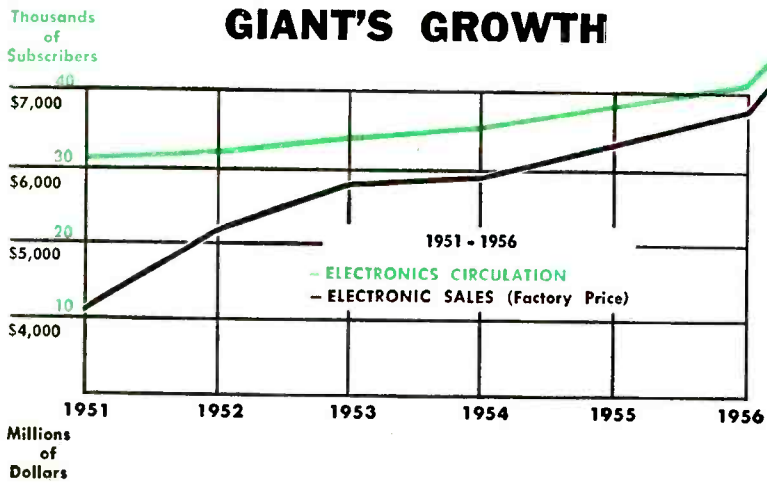



# HOW TO GROW with a GIANT

...keep pace with a \$6.8 billion industry in **electronics**

**It took a half century** for the electronic industry to grow to its present giant size!

But *you* can grow right along with this giant, starting NOW.

Your advertisements reach into *every* segment of the industry.

You'll be talking to *the* important men in it. More than 40,000 paid subscribers, an estimated 128,000 readers, look to **electronics** magazine for all the facts they need.

Have you something to say . . . to sell . . . electronic designers, producers, users?

Here's the place to *say* it . . . and *sell* it!

**electronics**  
...of course!

A MCGRAW-HILL PUBLICATION • 330 West 42nd Street • New York 36, N.Y.



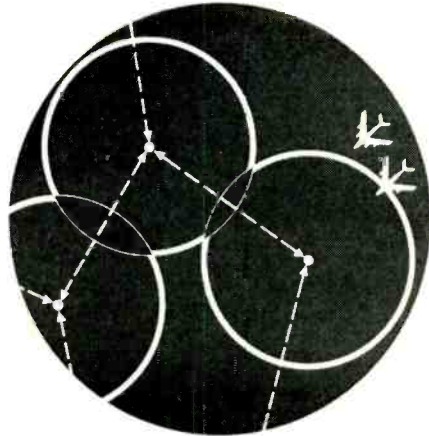

WEAPONS ASSIGNMENT

at Hughes

## NEW HORIZONS IN DATA PROCESSING

Hughes digital data processing systems are being used in the solution of one of our nation's most vital problems—defense against air attacks. In this age of atomic weapons and high-speed, high-altitude bombers, defense systems had to be developed which would supply anti-aircraft weapons with data on the position, speed, and direction of enemy planes. Hughes data processing systems surpass the most stringent requirements of modern anti-aircraft defense. Data may be received from many sources simultaneously; complex computing functions are carried out automatically; and data distribution is nearly instantaneous.

In the Hughes anti-aircraft defense systems, target information is received from radar stations. The system then accomplishes detection, identification, and tracking of enemy targets; storage and evaluation of the target data; and distribution of target and weapons assignment data to the anti-aircraft batteries. The batteries are thereby effectively coordinated in repelling the enemy attack. By linking together a number of such systems for the exchange of tactical information, a tight defense perimeter can be formed against aerial attack from any direction.

The contributions of the Ground Systems Laboratory have helped to make Hughes the West's leading center for advanced electronics. Hughes offers its Engineers and Scientists excellent salaries, constant challenge, and the luxury of Southern California living. For further information concerning the great opportunities at Hughes write us at the address below.

HUGHES AIRCRAFT COMPANY

Culver City  
California

**HUGHES**

Scientific Staff Relations

Research and Development Laboratories

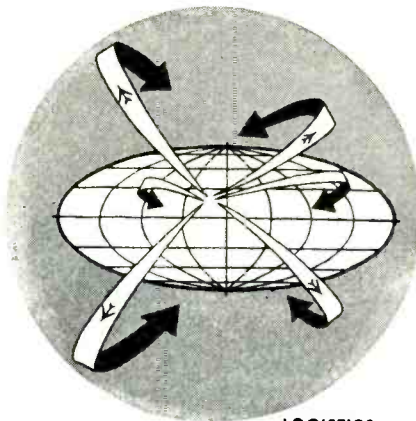

LOGISTICS

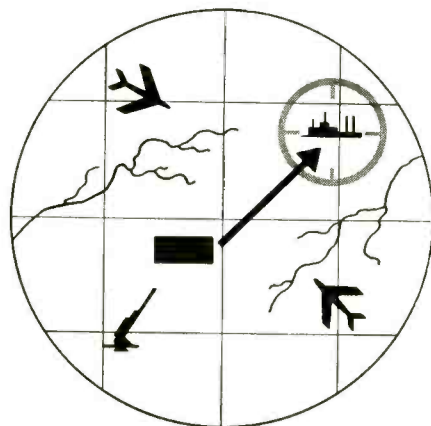

TARGET SELECTION

Some of the openings include:

### DEVELOPMENTAL DIGITAL CIRCUIT DESIGN ENGINEERS

with experience in one or more of the following fields: pulse circuits, computer techniques, magnetic core devices, timing and synchronizing circuits, scalars, storage devices, analog to digital and digital to analog converters, and counting tubes.

### ENGINEERS AND PHYSICISTS

for logical design of digital computer systems.

### ELECTRICAL OR MECHANICAL ENGINEERS

experienced in the equipment design of digital computers. These engineers should be capable of working with schematic diagrams to design complete equipment packages. Knowledge of etched circuit design techniques is desirable.

### COMPONENT ENGINEER

to select, evaluate or develop specialized components such as transformers, delay lines, capacitors, etc.

### DATA SYSTEMS ENGINEER

to work on digital data processing in the area of storage memories and computer-type processing circuits.

### MICROWAVE ENGINEER

for work on large high-gain antennas and transmission lines.





ACTUAL SIZE



**THEY MAY LOOK ALIKE—BUT**  
*there is a difference... and the difference*  
*is inside, where it counts.*

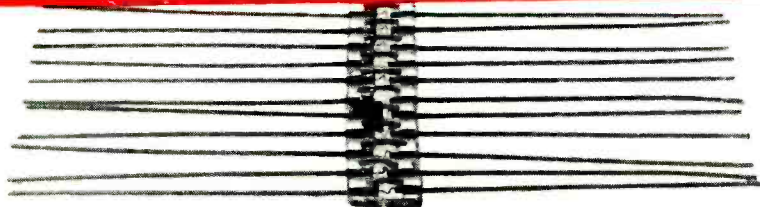

All Hughes diodes resemble each other—externally. Germanium point-contact or silicon junction, they are all glass-bodied\* and tiny (actual dimensions: 0.265 by 0.105 inch). But minute, meticulously controlled variations in the manufacturing process impart individual characteristics to the diodes, make them just right for specific applications. This gives you the

opportunity of selecting from a line which includes literally hundreds of diode types.

So, when your circuitry requires varying combinations of such characteristics as . . . high back resistance . . . quick recovery . . . high conductance . . . or high temperature operation, *specify Hughes*. You will get a diode with mechanical and electrical stability built in. You will get a diode which

was manufactured first of all for reliability.

\*Nowhere else have glass packaging techniques been developed to a comparable extent, for the Hughes process has many unique aspects. They are difficult to duplicate, yet are instrumental to the manufacture of diode bodies which are completely impervious to contamination and moisture penetration.



**HUGHES PRODUCTS**

A DIVISION OF THE HUGHES AIRCRAFT COMPANY

For descriptive literature please write: HUGHES PRODUCTS • SEMICONDUCTORS

International Airport Station, Los Angeles 45, California

© 1956, H. A. C.

ELECTRONICS — October, 1956

Want more information? Use post card on last page.

107

# Make this test yourself

and prove "Dutch Boy" Solder with  
Activated Rosin Flux\* gives you

**50-100% faster soldering**  
**50-60% more soldering "mileage"**

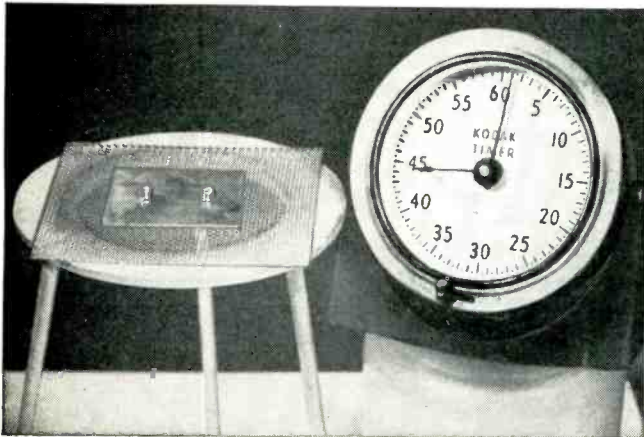

**Set test up like this!** Place one-inch, doubled-up samples of ordinary rosin core and "Dutch Boy" *activated* rosin core solders on sheet of clean copper. (In these pictures, "Dutch Boy" sample is on your right.)

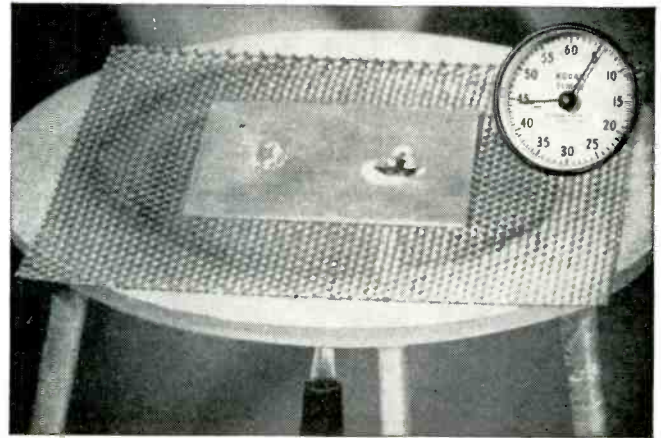

**Center torch flame under the copper sheet!** Notice how the flux runs out — "Dutch Boy" a little ahead. All at once, the "Dutch Boy" sample melts, the special flux helping to conduct heat through the solder.

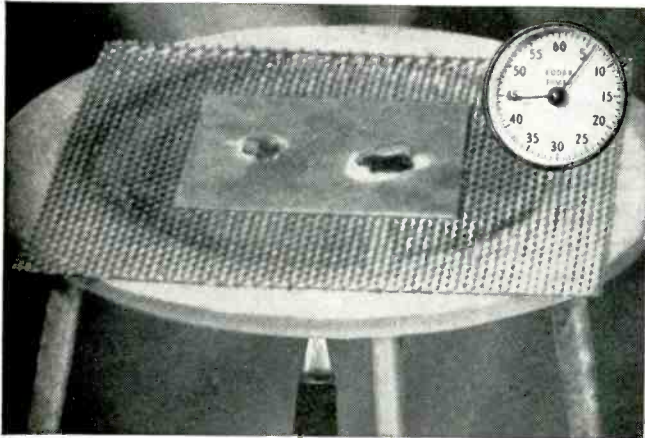

**Keep the heat on!** A second or so later, the ordinary solder starts to melt. But look at the "Dutch Boy" sample. See how it has spread . . . thanks to superior wetting properties of the activated flux.

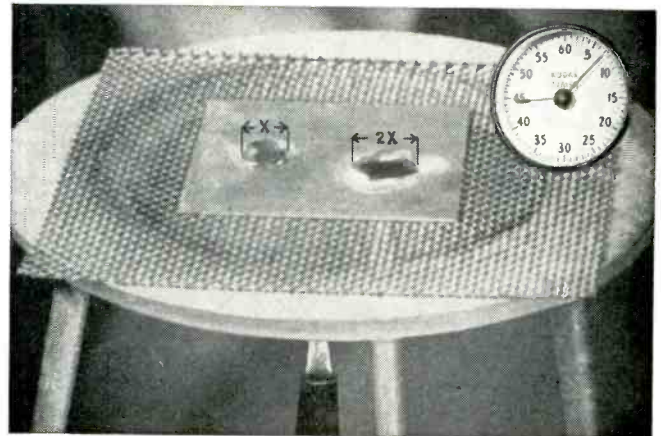

**Stop the clock** when the ordinary solder reaches maximum spread (two to four seconds). No need to measure. "Dutch Boy", with *activated* flux, covers over 60% more area.

\*"Dutch Boy" rosin core wire solder with activated flux sold under trade names "NUAX" and "HYAX".

## Look to National Lead for . . .

1. **Solders and fluxes** . . . all "standard" and "specification" types, forms, and pre-forms.
2. **Solder application help** . . . National Lead specialists in metal-joining jobs are at your service . . . literally. They have the "backing" of plant laboratories all over the country and of the central Research Labs in New York.

## What do users say?

Major producers of electronic equipment report "Dutch Boy" solder with "Dutch Boy" *activated* flux gives them 50 to 60% more joints per pound. Piece workers swear by it. Costs move down.

But don't take *anybody's* word for it. Try it yourself. Send for free samples. Write National Lead Company, 111 Broadway, New York 6, N. Y.

**"Dutch Boy" solders and fluxes**





**HOW  
LONG**

**A WORD IS..**

**service**

With  
The **FIRST**

\* THE FIRST SIX — Six leading, independent manufacturers' representatives functioning cooperatively for the advancement of improved electronic instrumentation in industry.

The Dictionary says "Service" is "The Act of Helping another or promoting his interests in any way."

Applying the dimension of time to this definition, the answer becomes obvious: — SERVICE IS AS LONG AS THE LENGTH OF TIME IT IS RENDERED.

. . . intelligent sales service actually begins BEFORE the sale through the sound recommendations of qualified FIRST SIX engineers.

. . . intelligent sales service CONTINUES with authoritative, technical assistance both in the selection of proper instruments — and in their practical applications.

. . . intelligent sales service further EXTENDS to back each sale with an experienced service department factory-trained to provide efficient maintenance.

No doubt about it, service reaches its LONGEST dimension when you're being helped by the FIRST SIX.  
*Put that advantage to work for you!*

**A. CROSSLEY ASSOC., INC.**

Chicago, Ill.  
Dayton, Ohio  
St. Paul, Minn.

**S. STERLING CO.**

Detroit, Mich.  
Cleveland, Ohio  
Dayton, Ohio

**HORMAN ASSOC., INC.**

Washington, D. C.

**THE I. E. ROBINSON CO.**

Philadelphia, Pa. — (Upper Darby)  
Camp Hill, Pa.  
Asbury Park, N. J.

**J. D. RYERSON ASSOC., INC.**

Syracuse, N. Y.

**YEWELL ASSOC., INC.**

Waltham, Mass.  
Bridgeport, Conn.

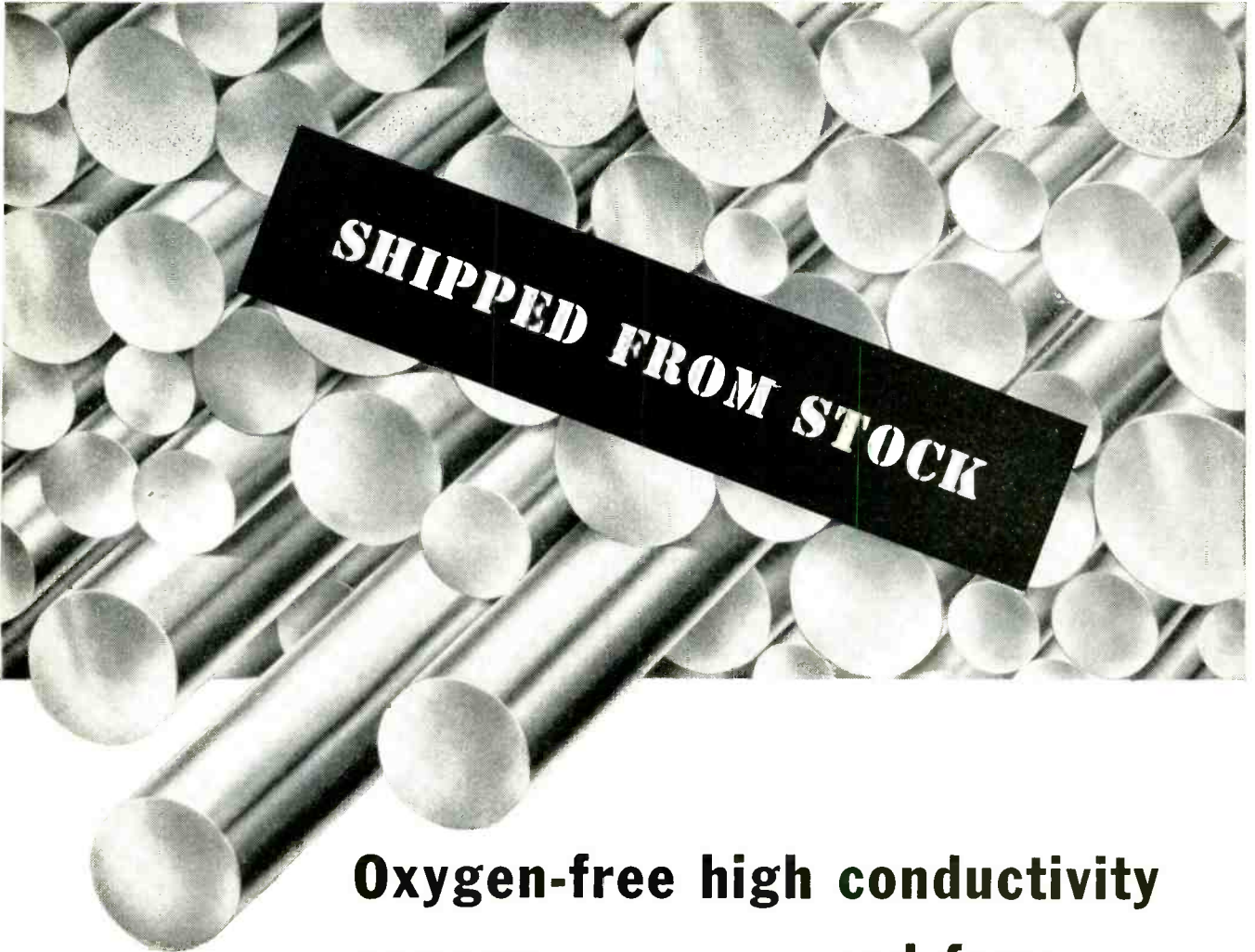

**SHIPPED FROM STOCK**

## **Oxygen-free high conductivity copper . . . in convenient rod form**

### **Tube manufacturer ends rejects by using PB&B O.F.H.C. copper rod**

A major manufacturer of transmitting tubes was getting rejects of approximately 2 per cent in finished tubes, due to microscopic leaks in a copper part made from extruded rod. Each reject meant loss of a tube worth nearly \$100. This source of high vacuum leakage was impossible to detect before assembly. Since switching to O.F.H.C. hot rolled rod, supplied by PB&B, rejects from this cause have completely vanished.

Need *certified grade* O.F.H.C.<sup>®</sup> copper rod—for use in vacuum tubes or other electrical or electronic equipment?

We can supply you quickly from stock, to highest quality standards. You'll find this material useful and economical in many special applications. It is pre-forged and hot rolled, to produce a dense, homogeneous grain structure free from microscopic porosity. It is not subject to hydrogen embrittlement during hydrogen atmosphere brazing. We certify its conductivity to be at least 98% I.A.C.S.

Cold-straightened rod, in diameters of  $\frac{3}{4}$ ", 1", 1 $\frac{1}{4}$ ", 1 $\frac{3}{8}$ ", 1 $\frac{1}{2}$ " and 1 $\frac{5}{8}$ ", to standard hot rolled tolerances, is regularly stocked in "as rolled" condition. You can order in random lengths, or we can cut to your specifications.

*Write today for a quotation on your particular requirements.*

® Registered Trade Mark  
The American Metal Co. Ltd.

**PHILADELPHIA  
BRONZE & BRASS CORP.**

22nd and Master Streets, Philadelphia 21, Pa.

—a subsidiary of

**P. R. MALLORY & CO. Inc.**  
**MALLORY**

**It will take  
still more years of testing  
—at  $1.89 \times 10^9$  operations a year—  
to fix the life span of this relay**

• *When we first claimed a life of a billion operations for CLARE Mercury-wetted Contact Relays, we were guilty of a serious understatement.*

**Here is the proof:**

A life test was started in January, 1955. The relays on test are carrying a contact load of 5 amperes at 50 volts d-c (resistive load). A suitable spark suppressor is employed.

These relays have been operating continuously at a rate of 5,184,000 operations a day ever since, without any attention whatsoever.

As this is written they are closely approaching the 3 billion mark, with every indication they will go on operating for years.

*Think of it! Here is a relay that in normal service will outlast a man's lifetime!*

**Have you a job for which none but the best relay is good enough?  
It can cost you much more to settle for less than this CLARE RELAY.**

**Price is reasonable. Prices for Multi-element Mercury-wetted Contact Relays have recently been reduced. Delivery is quick—a few days to a few weeks, depending on assembly desired and size of order.**

**FOR COMPLETE INFORMATION** on CLARE Mercury-wetted Contact Relays for single or multiple circuits contact your nearest CLARE representative or address: C. P. CLARE & Co., 3101 Pratt Blvd., Chicago 45, Illinois. *In Canada:* C. P. CLARE & Co., 659 Bayview Avenue, Toronto 17. Cable address: CLARELAY.

**Send for CLARE Sales Engineering Bulletins Nos. 120 and 122**

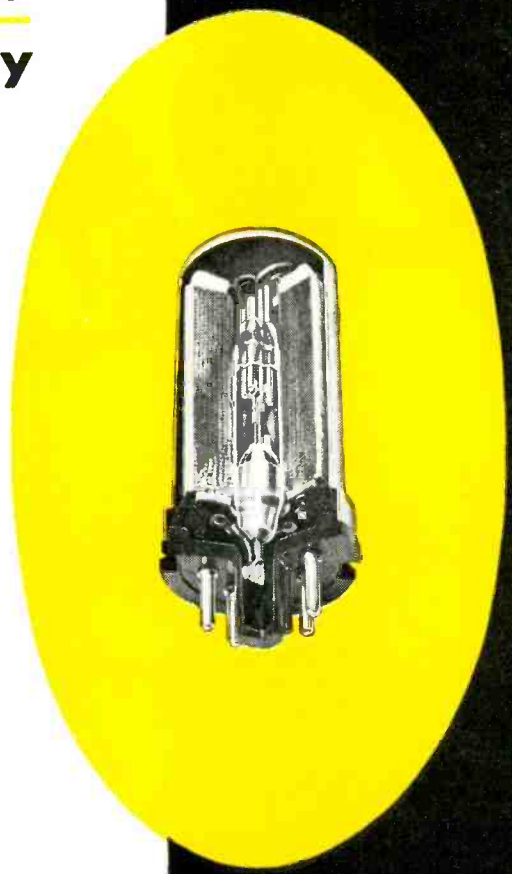

**CLARE RELAYS**

FIRST in the industrial field

# P6M

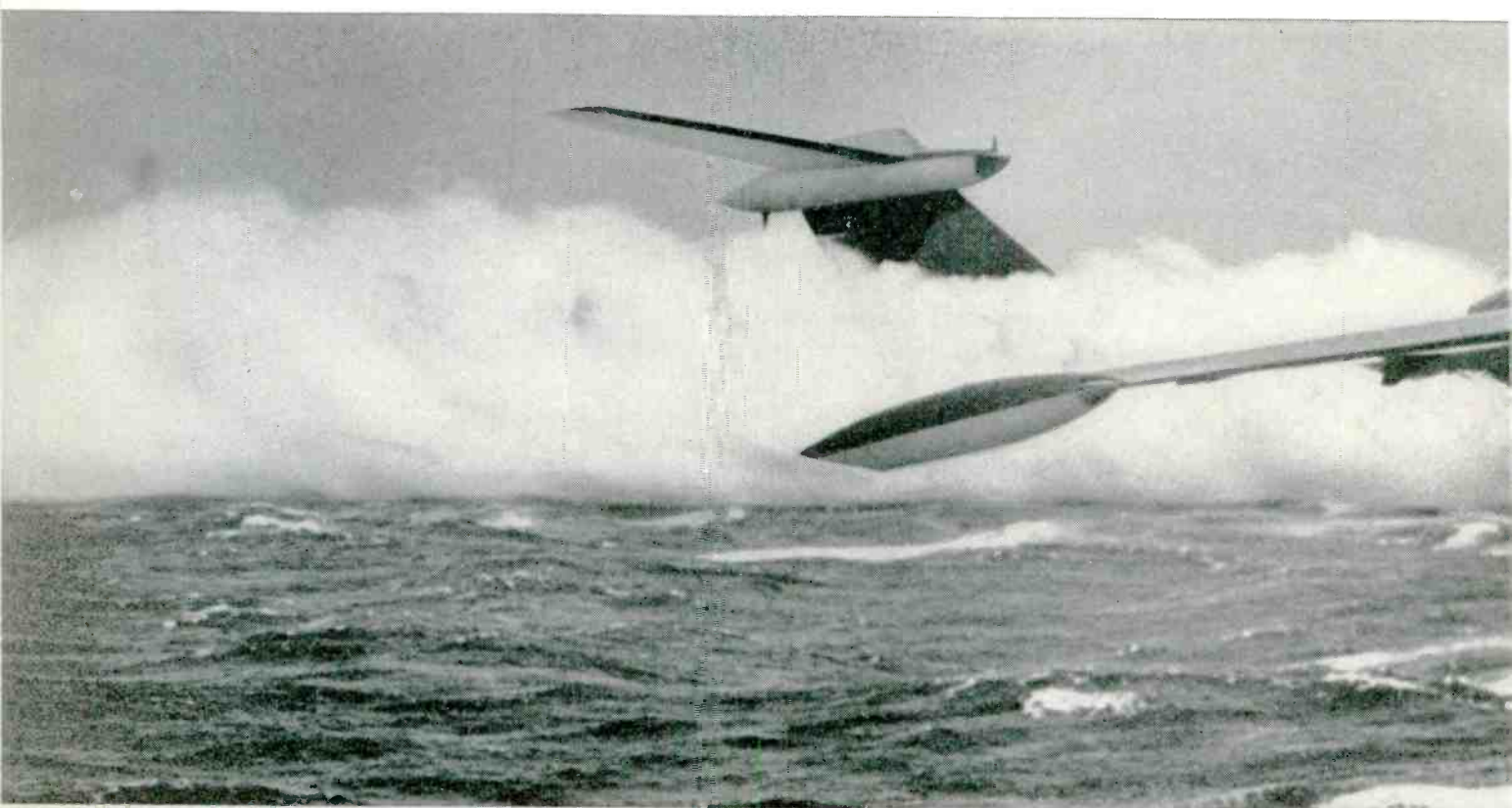

This is one of the most important and exciting aircraft in the world. It is the new Martin SeaMaster, the Navy's first multi-jet attack seaplane. It is now in production and soon to be in fleet service as the spearhead of a powerful new arm of the naval arsenal—the Seaplane Striking Force. The SeaMaster's importance is a matter of inevitability: It is in the over 600 *mph* class, with a normal cruise altitude of 40,000 feet, an unrefueled combat radius of 1,500 miles, and is operable in "Sea State 3" (waves averaging 6 feet) with a payload of 30,000 pounds. Thus, the endless runways of this world's oceans, lakes and estuaries provide unlimited and indestructible bases for SeaMaster operation, making it the first aircraft of any type having global striking power, independent of fixed installations. *For virtually the whole of our habitable world is within flight minutes of open water!* This new aircraft development is another powerful reason why the U. S. Navy offers to the military enlistee one of the most exciting futures in the world today.

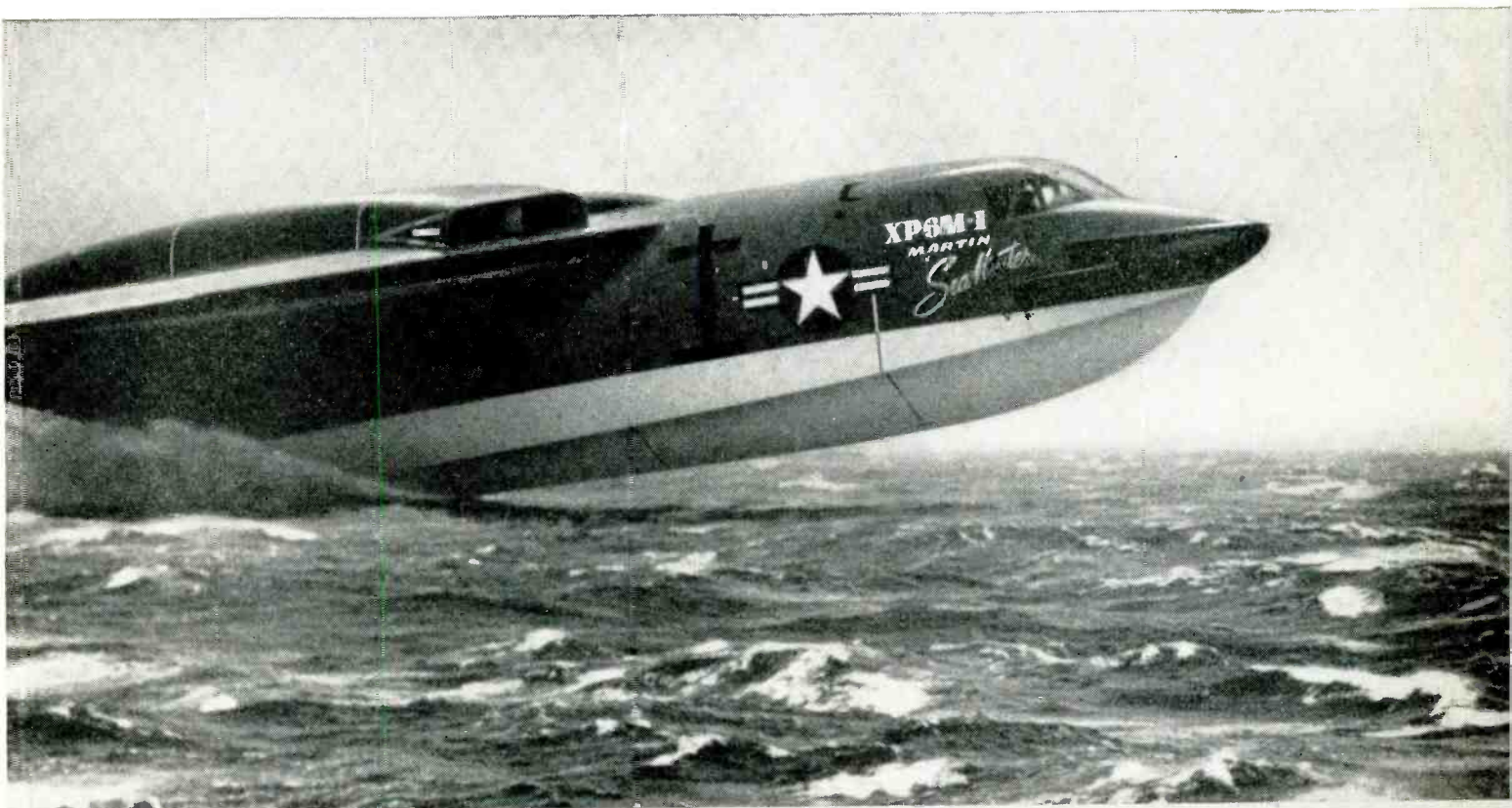

---

**MARTIN**  
BALTIMORE · DENVER

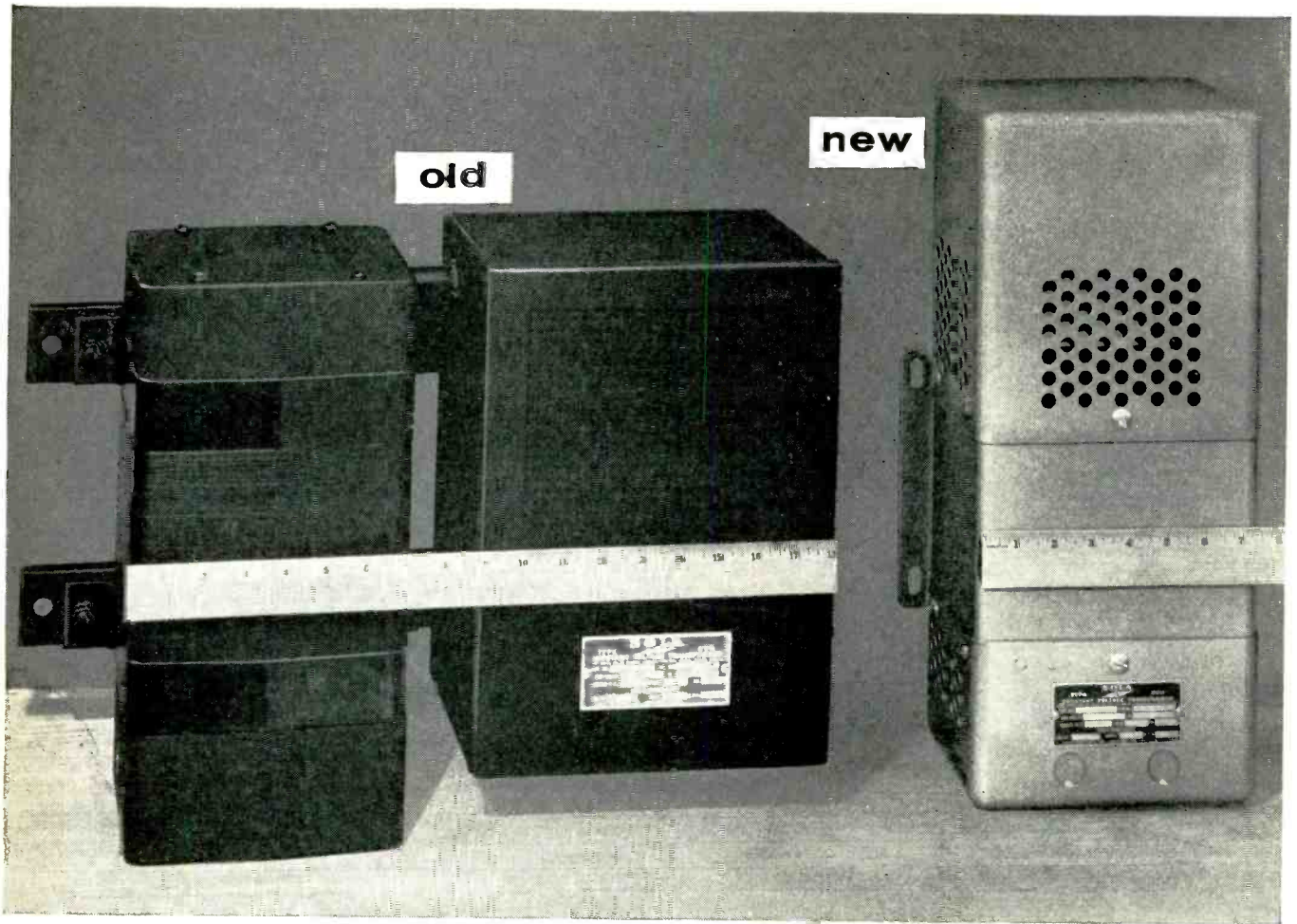

**SMALLER SIZE, LIGHTER WEIGHT** of the new Sola Type CVH regulating transformer design is shown by the comparison of 1000va units shown above. The new unit shown at the right utilizes a single,

rectangular housing that replaces the core-and-coil-assembly and separate neutralizer component. Also available in the new design are 250 and 500va capacities. Finish is gray hammerloid.

## New Sola Harmonic-Neutralized Constant Voltage Transformers greatly reduced in size and weight

Now the valuable performance features of the Sola Harmonic-Neutralized Constant Voltage Transformer (Type CVH) are offered in a new unit design that provides up to 60% reduced size and 54% lighter weight. In addition to significant size and weight reductions, the new Sola Type CVH regulator design provides the lowest external field of any stock static-magnetic stabilizer available.

Essentially, electrical characteristics of the new Type CVH regulator are unchanged. Stabilization is  $\pm 1\%$  regardless of primary voltage swings over a newly-expanded range of 95-130 volts. Sinusoidal output is delivered with less than 3% harmonic distortion at rated

load. The nominal output rating has been raised to 118 volts to correspond with similar input reratings of electronic and other equipment.

Sola harmonic-neutralized regulators may be used for the most exacting applications with equipment having elements which are sensitive to power frequencies harmonically related to the fundamental. They are especially suitable for input to a rectifier when close regulation of the dc output is required.

New design Sola Type CVH regulators are available in three capacities — 250, 500, and 1000va. For specific advice on your particular application, consult your Sola representative listed below.

**SO LA** *Constant Voltage*  
**TRANSFORMERS**



Request Explanatory Circular

SO LA ELECTRIC CO.  
4633 W. 16th Street  
Chicago 50, Illinois

CONSTANT VOLTAGE TRANSFORMERS • FLUORESCENT LIGHTING BALLASTS • MERCURY VAPOR LIGHTING TRANSFORMERS  
SO LA ELECTRIC CO., 4633 West 16th Street, Chicago 50, Illinois, Blshop 2-1414 • NEW YORK 35: 103 E. 125th St., TRafalgar 6-6464  
PHILADELPHIA: Commercial Trust Bldg., Rittenhouse 6-4988 • BOSTON: 272 Centre Street, Newton 58, Mass., Bigelow 4-3354 • CLEVELAND 15:  
1836 Euclid Ave., Prospect 1-6400 • KANSAS CITY 2, MO.: 406 W. 34th St., Jefferson 4382 • LOS ANGELES 23: 3138 E. Olympic Blvd., Angelus  
9-9431 • SO LA ELECTRIC (CANADA) LTD., TORONTO 17, ONTARIO: 102 Laird Drive, Mayfair 4554 • Representatives in Other Principal Cities



# HUBBELL *Interlock* PLUGS and TRADE-MARK TERMINAL STRIPS

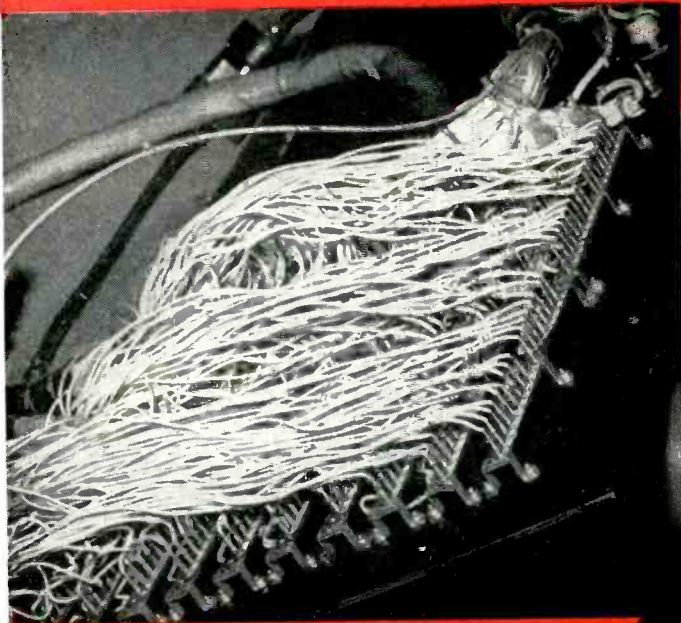

Close-up of Analyzer's junction box. Note how Type "A" Interlock Plugs lock securely into Hubbell Terminal Strips. Wires cannot be disconnected accidentally, yet plugs will release quickly and easily when intended.

Help to **TEST**  
 THOUSANDS OF FEET  
 OF WIRE *IN MINUTES*  
 FOR **TWA**

Automatic Locking — Quick Disconnect Plugs  
 in **DIT-MCO** Circuit Analyzer\*  
 Provide Accurate Readings for  
 Aircraft Circuits

Interlock Plugs and Jacks provide a positive, locked connection between each aircraft circuit and the Circuit Analyzer to assure accurate readings every time. Hundreds of circuits can be connected or rearranged in minutes with these automatic-locking, quick-disconnect plugs.



Hundreds of aircraft electrical circuits, adding up to thousands of feet of wire, are tested in minutes by an analyzer connected by Hubbell Interlock Plugs. Only a locking contact, such as Interlock provides, can assure the uninterrupted flow of current and accuracy required for this vital circuit testing . . . and only plugs that disconnect so quickly and easily, when circuit changes are necessary, would be feasible in a mass wiring set-up such as this, used by Trans World Airlines, Inc. Hubbell Interlock Plugs and Connectors play an important part in this, as in a wide variety of applications that require absolute accuracy of readings. They are used by some of the world's largest manufacturers of electrical and electronic equipment.

\*Circuit Analyzer manufactured by DIT-MCO, Inc., Electronic Division, Kansas City, Mo.

For Complete Information On  
 Other Interlock Products, Write



## HARVEY HUBBELL, INC.

Interlock Electronic Connector Dept., Bridgeport 2, Conn.





**hp 523B ELECTRONIC COUNTER**

- ▲ Etched circuits, extreme reliability
- ▲ Rugged unitized construction
- ▲ Permits visual identification on oscilloscope of exact time interval measured
- ▲ High accuracy crystal oscillator circuit
- ▲ Trouble-localizer lights—plug-in circuit sections
- ▲ Counts pulses of selected levels for nuclear measurement

Check the exclusive features of the new *-hp-* 523B and see if you don't agree this is the most useful, convenient, and value-packed counter of its type ever offered commercially.

Construction throughout is of highest quality. Etched circuits are rugged and ultra-dependable. Circuits are arranged for complete accessibility and visibility. Trouble-localizer lights and plugs disconnecting circuit elements further simplify maintenance.

An exclusive feature of the *-hp-* 523B is the pulse output for oscilloscope Z-axis modulation making possible visible indication of exact time interval being measured. Other important features include a pulse count discriminator counting only pulses of voltage above a pre-determined level, and a high accuracy crystal oscillator circuit for maximum stability. Con-



# Time or 10 cps to

trols are color-coded and concentric, arranged by function. Readings are direct in clear, bright numerals visible under all light conditions. The automatic decimal point is also brightly illuminated.

## FREQUENCY, PERIOD, TIME

In frequency counting, Model 523B covers 10 cps to 1.1 MC with accuracy of  $\pm 1$  count  $\pm$  crystal stability of 2/1,000,000 per week. Time base crystals are pre-aged. For ultimate accuracy, a front panel connector permits application of a 100 KC external standard. Gate times are 0.001, 0.01, 0.1, 1 and 10 seconds. The gate also may be operated manually.

In period measurement, the unknown controls gate opening and closing, while the 523B's high-dependability *-hp-* AC-4A Decade Counters record cycles of an internal standard frequency. The result is a 10-period average measurement which reduces ten-fold effects of any triggering uncertainty. Period may be measured from 0.00001 cps to 10 KC in seconds, milliseconds or microseconds.

*-hp-* 523B also measures time from 3  $\mu$ sec to 100,000 seconds (27.8 hours.) Results are presented directly in seconds, milliseconds and microseconds. A threshold feature permits measurements to be started and stopped only by signals of pre-determined amplitude, polarity and slope. Separate adjustable stop and start channels are provided for maximum flexibility. Measurements may be started or stopped at any level from  $-300$  to  $+300$  volts on positive or negative slopes.

## BROADEST USEFULNESS

In addition to industrial use as a precision counter of production quantities, *-hp-* 523B is ideal for measuring nuclear pulses, power line frequencies, rps and rpm, very low frequencies, oscillator stability and repetition rates. With suit-

**hp provides complete coverage in quality**

# Direct Frequency Period Readings

## 1.1 MC!

able transducers, local or remote measurements of weight, temperature, pressure, acceleration and other phenomena may be made.

-hp- 523B also quickly and conveniently measures time between impulses, pulse lengths, shutter speeds, projectile velocity, relay operating times, precise event timing, interval stability, frequency ratios, phase delay, etc.

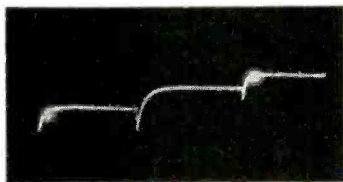

Fig. 1. Visual presentation is extremely helpful when studying complex waveforms. Exclusive -hp- 523B pulse output for 'scope Z-axis modulation permits viewing time-interval start and stop points on waveform being measured.

## Specifications

### FREQUENCY MEASUREMENT:

Range: 10 cps to 1.1 MC.  
Accuracy:  $\pm 1$  count  $\pm$  stability (see General).  
Input Requirements: 0.2 volt rms minimum.  
Input Impedance: Approx. 1 megohm, 30  $\mu$ f shunt.  
Gate Time: 0.001, 0.01, 0.1, 1, 10 seconds.  
Reads In: KC; decimal point automatically positioned.

### PERIOD MEASUREMENT:

Range: 0.00001 cps to 10 KC.  
Accuracy:  $\pm 0.3\%$  (for measurements of one period),  $\pm 0.03\%$  (10 period average) at 1 volt rms. Improved by greater input voltage.  
Input Requirements: 1 volt rms minimum. Direct coupled.  
Input Impedance: Approx. 1 megohm, 40  $\mu$ f shunt.  
Gate Time: 1 or 10 cycles of unknown.  
Standard Frequency Counted: 10 cps, 1 KC, 100 KC, 1 MC, or external applied frequency.  
Reads In: Seconds, milliseconds, microseconds; decimal point automatically positioned.

### TIME INTERVAL MEASUREMENT:

Range 3  $\mu$ sec to 100,000 sec. (27.8 hours).  
Accuracy:  $\pm 1$ /std. freq. counted  $\pm$  stability (see General).

Input Requirements: 1 v peak minimum. Dc coupled.  
Input Impedance: Approx. 1 megohm, 25  $\mu$ f shunt.  
Start and Stop: Independent or common channels.  
Trigger Slope: Positive or negative on start and/or stop channels.  
Trigger Amplitude: Continuously adjustable on both channels from -300 to +300 volts.  
Std. Freq. Counted: 10 cps, 1 KC, 100 KC, 1 MC; External.  
Reads In: Seconds, milliseconds, microseconds; decimal point automatically positioned.

### GENERAL:

Registration: Six places on neon lamp decade units.  
Stability: 2/1,000,000 per week. May be standardized against WWV.  
Display Time: Variable approx. 0.1 to 5 seconds; display held indefinitely if desired.  
Output Frequencies: Secondary standard frequencies available at front panel: 10 cps, 1 KC rectangular, 100 KC and 1 MC sine-wave (stability as above).  
Trigger Output: Start and Stop pulse output (width approx. 0.5  $\mu$ sec). Available for:  
1. Voltage level selection of input signal for frequency measurements.  
2. Z-axis modulation of oscilloscope for time interval measurements.  
Self Check: Panel control provides automatic count of internal 100 KC and 1 MC frequencies to assure accuracy of gate and proper operation of counters.  
External Standard: 100 KC from external primary standard can be applied to unit for highest accuracy.  
Power: 115/230 volts  $\pm 10\%$ , 50/60 cps. approx. 285 watts.  
Dimensions: Cabinet Mount: 13 $\frac{3}{4}$ " wide x 16 $\frac{1}{4}$ " high x 21" deep. Rack Mount: 19" wide x 14" high x 21" deep.  
Weight: Net: 48 lbs. Shipping: 85 lbs. (cabinet mount).  
Accessories Furnished: 2 AC-16D Cable Assemblies.  
Price: \$1175.00.

*Data subject to change without notice. Prices f.o.b. factory.*



**SEE YOUR -hp- REPRESENTATIVE OR  
WRITE DIRECT FOR DATA SHEETS**

**HEWLETT-PACKARD COMPANY**

3637A PAGE MILL ROAD, PALO ALTO, CALIFORNIA, U.S.A.

Cable "HEWPACK"

DAvenport 5-4451

FIELD ENGINEERS IN ALL PRINCIPAL AREAS

**electronic counters. Request details.**

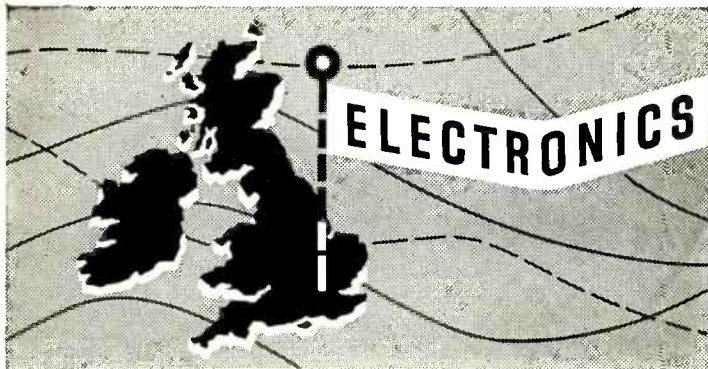

*in Britain*

The British Electronics Industry is making giant strides with new developments in a variety of fields. Mullard tubes are an important contribution to this progress.

**For medium power equipments**

**British high fidelity experts choose the**

The Mullard range of high fidelity tubes is accepted in Britain as the standard by which others are judged. This is because many years of research and development have been spent in producing a range that will meet the requirements of high fidelity sound reproduction in all respects. Take the Mullard EL84 for example. A pair of these tubes provide a power output of 10W at a distortion level of less than 1%. Furthermore, their transconductance of over 11,000  $\mu$ mhos results in an exceptionally high sensitivity. The EL84 may be used for higher powers too. Two tubes in push-pull will provide outputs of up to 17W at an overall distortion of 4%.

At maximum ratings one EL84 has a plate dissipation of 12W and gives an output of 5-6W for an input signal of less than 5V r.m.s.

Supplies of the EL84 for replacement in British equipments are available from the companies mentioned below.

**EL84**



**Principal Ratings**

Heater	.....	6.3V, 0.76A
Max. plate voltage	.....	300V
Max. plate dissipation	.....	12W
Max. screen voltage	.....	300V
Max. screen dissipation (max. signal)	.....	4W
Max. cathode current	.....	65mA

**Base**

Small button noval 9-pin

**Supplies available from:—**

**In the U.S.A.** International Electronics Corporation,  
Dept. E10, 81 Spring Street, N. Y. 12, New York, U. S. A.

**In Canada** Rogers Majestic Electronics Limited,  
Dept. I-M, 11-19 Brentcliffe Road,  
Toronto 17, Ontario, Canada.

**Mullard**

**ELECTRONIC TUBES**

*used throughout the world*

MULLARD OVERSEAS LTD., CENTURY HOUSE, SHAFTESBURY AVE., LONDON, ENGLAND

Mullard is the Trade Mark of Mullard Ltd. and is registered in most of the principal countries of the world.



MEV37

when a "standard type" of vibrator won't do . . .

# OAK

## vibrators

CUSTOM DESIGNED and CUSTOM BUILT

**complete engineering cooperation** from prototype to production

With information about what you want to accomplish, in voltage, current, signal or frequency conversion for your performance, environmental and load conditions, OAK can pre-engineer for your application by:

- *Designing or checking your circuit.*
- *Specifying protective components.*
- *Designing your transformer.*  
*(we do not manufacture transformers).*
- *Designing and producing your vibrators—in any quantity.*

*vibrator performance and life depend on its suitability to the application.*



send for descriptive brochure and performance chart—address dept. "O"

### OAK MFG. CO.

1260 clybourn ave. • chicago 10, ill.

also manufacturers of OAK switches, tuners, choppers and other electro-mechanical devices.





# Ucinite Magnetron Connectors

Ucinite manufactures a variety of special connectors for the heater and heater-cathode terminals of magnetrons. Many of these have been adapted for special applications as to size and function to meet the sealing and mounting requirements of high temperature and high altitude operation and other special conditions.

Connectors are coaxial in construction and can be supplied with built-in capaci-

tors for added protection. Connecting leads of any length can be furnished to customer's specifications.

With an experienced staff of design engineers, plus complete facilities for volume production, Ucinite is capable of supplying practically any need for metal or metal-and-plastics assemblies. Call your nearest Ucinite or United-Carr representative for full information or write directly to us.



**The**  
**UCINITE CO.**  
*Newtonville 60, Mass.*  
 Division of United-Carr Fastener Corp.

*Specialists in*  
**ELECTRICAL ASSEMBLIES,**  
**RADIO AND AUTOMOTIVE**

# **NEW THREAD CUTTING FASTENER**

- LOW COST
- RE-USABLE
- SELF-LOCKING
- VIBRATION-PROOF
- SPRING TAKE-UP

*Pulls up tight  
without backup on  
flat or contoured surfaces*

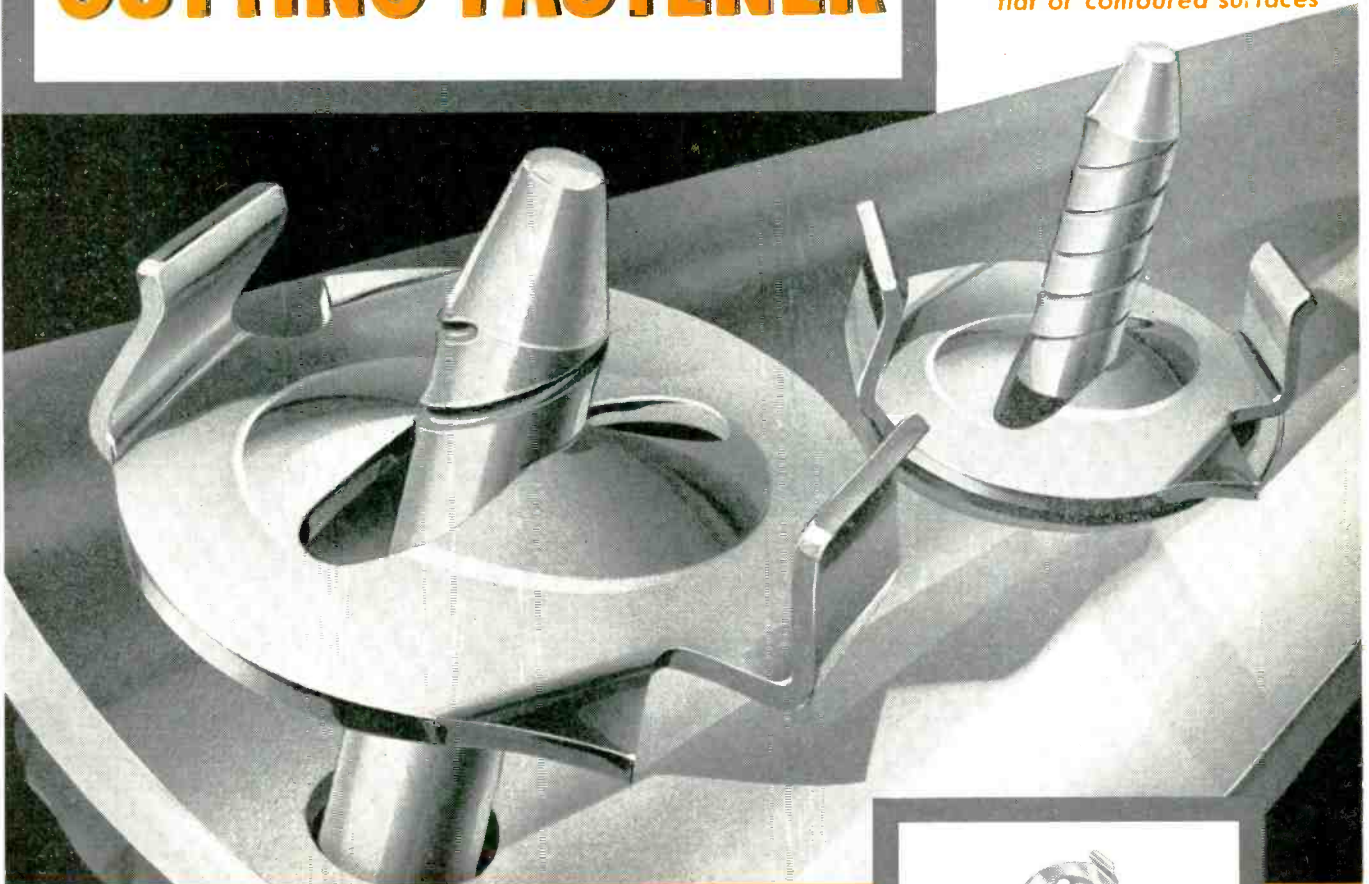

Specially designed to hold die-cast or cold-forged name plates, emblems and trim against sheet metal surfaces, DOT's new T. C. F. cuts clean, deep threads on unthreaded studs, even those that are chrome plated. Immediately available to fit 1/8" and 3/16" studs.

When used with its pre-assembled plastic sealer, the new T. C. F. makes a watertight seal. The sealer *precedes* the fastener onto the stud so that it is not damaged by the thread-cutting process.

Available *in quantity* with or without sealer from Monadnock Mills subsidiary and Carr Fastener Division.

*United-Carr's design staff is ready to apply the same engineering creativity that produced the T. C. F. and thousands of other special-purpose fastening devices to the solution of your special fastening problems. Field representatives are located in most principal cities.*

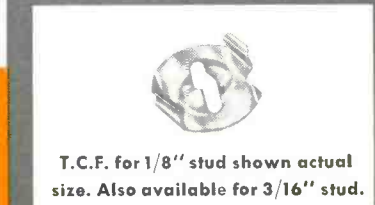

T.C.F. for 1/8" stud shown actual size. Also available for 3/16" stud.



T.C.F. for 1/8" stud with plastic sealer.

**MONADNOCK MILLS**  
SUBSIDIARY  
San Leandro, California



**CARR FASTENER CO.**  
DIVISION  
Cambridge, Massachusetts

U N I T E D - C A R R F A S T E N E R C O R P O R A T I O N

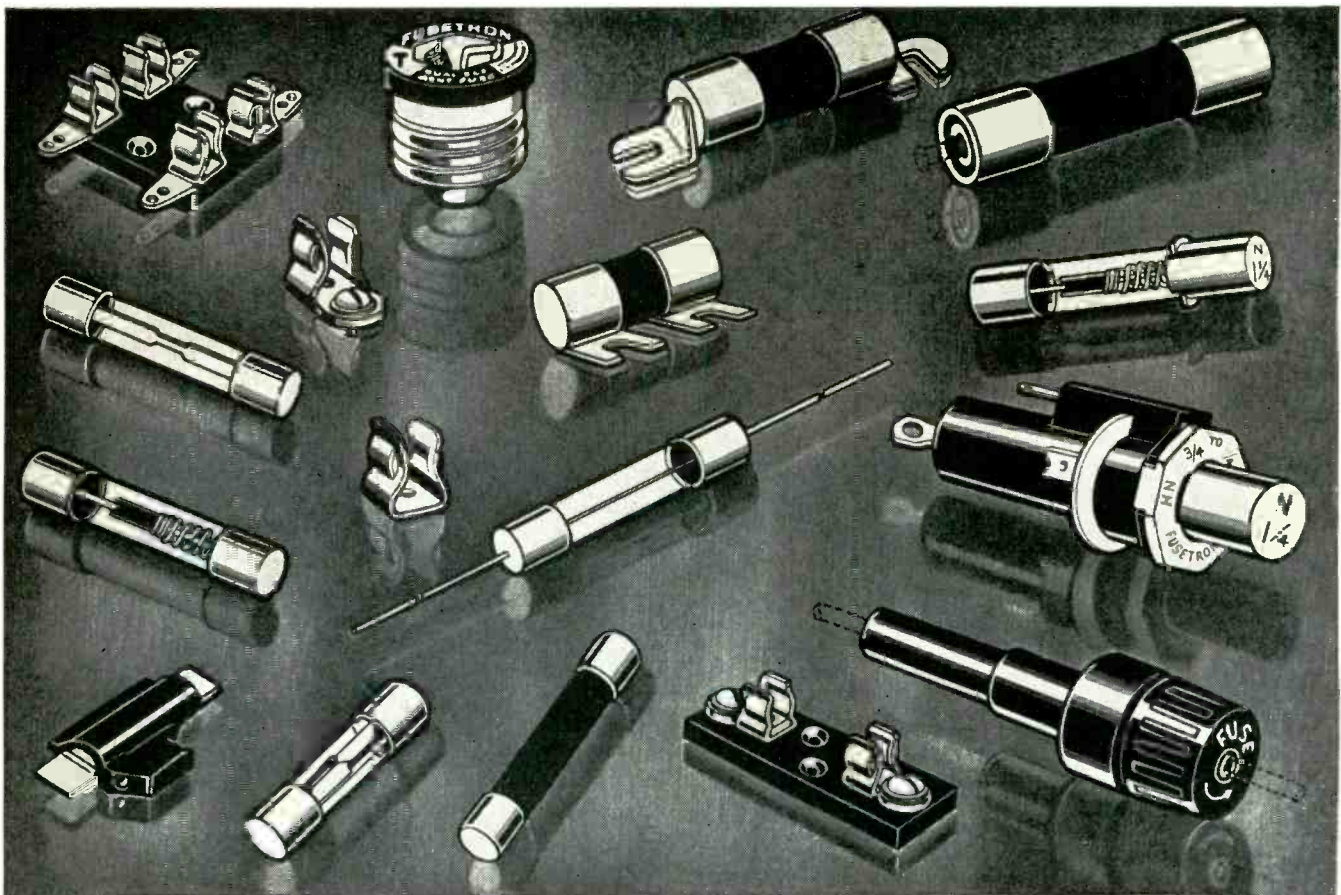

## For safe electrical protection — and the elimination of needless blows, rely on BUSS FUSES . . .

When electrical faults occur, BUSS fuses open and clear the circuit. The danger of damage to equipment is reduced to a minimum.



Yet, BUSS fuses are designed and engineered to eliminate needless blows. Your equipment operates as intended — and users are not plagued with irritating, useless shutdowns.



By standardizing on dependable BUSS fuses, you can help safeguard against loss of customer good will and the possibility of faulty fuses effecting the proper operation of your equipment.

*Save engineering time on difficult protection problems—The BUSS fuse engineers are always at your service to help you determine the fuse or fuse mounting best suited to your application. If possible, they will suggest a fuse already available in local wholesalers' stocks, so that your device can be easily serviced.*

*Be sure to get the latest information on BUSS and FUSETRON small dimension fuses and fuseholders . . . Write for bulletin SFB.*

**BUSSMANN MFG. CO.**  
(Div. McGraw Electric Co.)  
University at Jefferson St. Louis 7, Mo.

Makers of a complete line of fuses for home, farm, commercial, electronic, automotive and industrial use.



ERC  
1750



**THEY'RE  
CHECKING VIDEO EVERYWHERE**

WITH THE  
FAMOUS



Model 1003-B

**PORTABLE VIDEO TRANSMISSION  
TEST SIGNAL GENERATOR**

★ Completely self contained ★ Portable ★ Multi-frequency burst ★ Stairstep ★ Modulated stairstep  
★ White window ★ Composite sync ★ Regulated power supply.

**DELIVERY 30 DAYS**

Literature on the above and more than 100 additional instruments for monochrome and color TV by TELECHROME are available on request.

The Nation's Leading Supplier of Color TV Equipment  
28 Ranick Drive Amityville, N. Y.  
Lincoln 1-3160

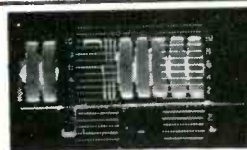

**MULTI-FREQUENCY BURST AMPLITUDE vs FREQUENCY.** Check wide band coaxial cables, microwave links, individual units and complete TV systems for frequency response characteristics without point to point checking or sweep generator.

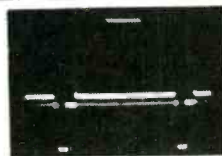

**WHITE WINDOW**  
**LOW & HIGH FREQUENCY CHARACTERISTICS.** Determine ringing, smears, steps, low frequency tilt, phase shift, mismatched terminations, etc. in TV signals or systems.



**STAIRSTEP SIGNAL** modulated by crystal controlled 3.579 mc for differential amplitude and differential phase measurement. Checks amplitude linearity, differential amplitude linearity and differential phase of any unit or system. Model 1003-C includes variable duty cycle stairstep (10-90% average picture level).

Model 608-A HI-LO CROSS FILTER for Signal analysis.



**MODULATED STAIRSTEP** signal thru high pass filter. Checks differential amplitude.

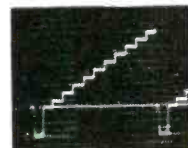

**MODULATED STAIRSTEP** signal thru low pass filter. Checks linearity.



**1004-A VIDEO TRANSMISSION TEST SIGNAL RECEIVER** for precise differential phase and gain measurements. Companion for use with 1003-B.



**1521-A OSCILLOSCOPE CAMERA**—Polaroid type for instantaneous 1 to 1 ratio photo-recording from any 5" oscilloscope.

# Specify SYLVANIA WIRE



TUNGSTEN

50/50 TUNGSTEN-  
MOLYBDENUM

MOLYBDENUM

## ...when your product demands the highest standard of uniformity

BECAUSE of high metal purity plus exceptional uniformity in size and physical properties, Sylvania wire will help you hold rejection losses to a minimum . . . help you maintain consistently higher product performance standards.

Quality-controlled to the exacting standards known to be needed for producing the world's finest vacuum tubes—every step in the wire-making process is done in Sylvania's own plants. From metal refining to drawing and finish plating . . . one manufacturer bears the entire responsibility of supplying the exact kind and quality of wire you need.

There is a Sylvania wire for every vacuum and gas tube application, in a full range of sizes down to the finest available—bare or plated with gold, rhodium, silver or nickel. Extra-long lengths can be supplied on order.

As the specifications for tube characteristics vary—so your wire requirements will vary. Next time you need standard or special wires, call in your Sylvania sales engineer. He will help you get exactly what you need, *when you need it!*

SYLVANIA ELECTRIC PRODUCTS INC.  
Tungsten and Chemical Division, Towanda, Penn.

TUNGSTEN

MOLYBDENUM

CHEMICALS

PHOSPHORS

SEMI-CONDUCTORS



# SYLVANIA



Lighting • Radio • Electronics • Television • Atomic Energy

*Relay Sales*

Telephone Relays

Midget Relays

Keying Relays

Rotary Relays

Sealed Relays

Sensitive Relays

Latching Relays

Stepping Relays

Delay Relays

Timers

Contactors

Motor Starting Relays

Differential Relays

Polarized Relays

AN Approved Relays

# RELAYS

*QUICKLY* supplied from stock!

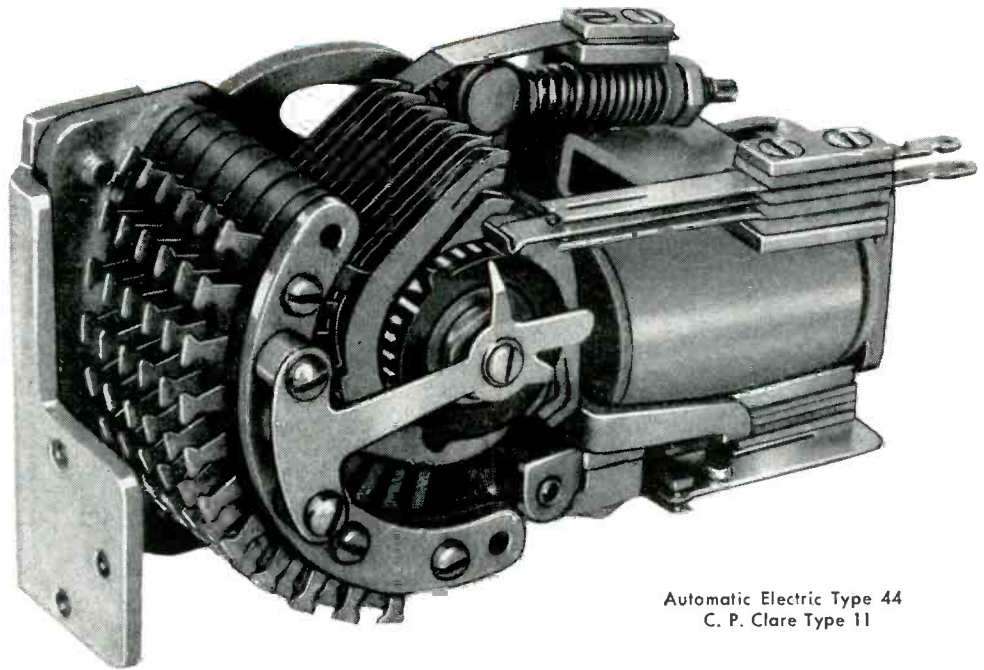

Automatic Electric Type 44  
C. P. Clare Type 11

### Substantial Quantities of Every Type On Hand

Large or small orders for relays of any type are filled immediately from our comprehensive stock. We save you weeks and months of delivery time. You are relieved of inventory problems and production delays. Call us.

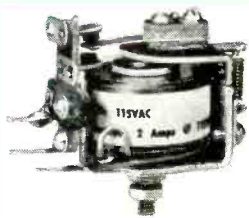

ADVANCE



SCHRACK CONTROLS



STRUTHERS-DUNN



TERADO

Write for new  
24 page catalog C-7

*Relay Sales*

Authorized Distributors for Major Relay Manufacturers.  
All relays are new, inspected and guaranteed. Phone us for same day shipment.

Phone West Chicago 1100

Write for new 24 page catalog C-7

**RELAY SALES, INC.**

P. O. BOX 186 - A • WEST CHICAGO, ILL.

# UNIT RECTIFIERS

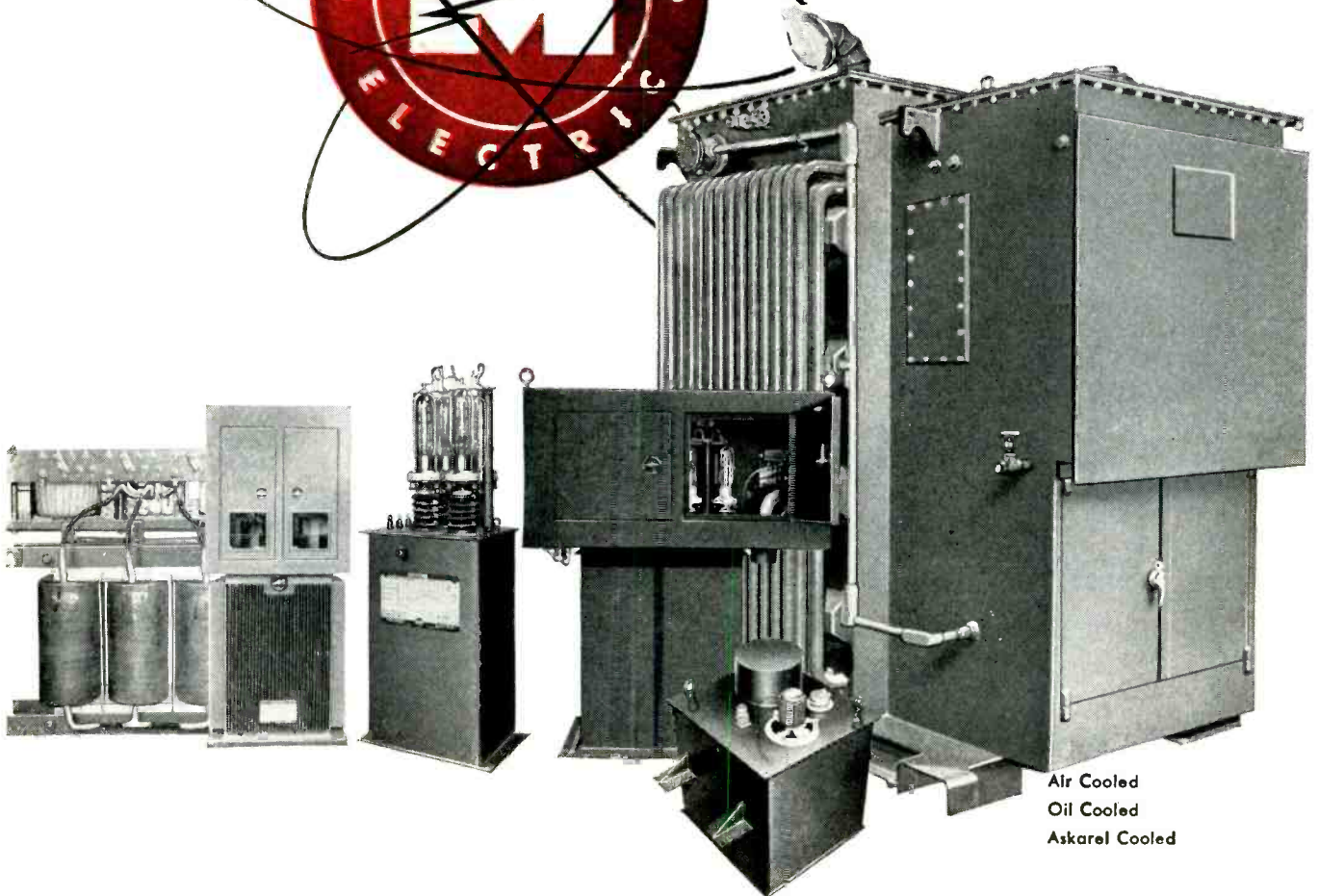

Air Cooled  
Oil Cooled  
Askarel Cooled

... meet all essential requirements of AC to DC voltage conversion.

Moloney's advanced design means:  
Reduced Weight • Easier Handling • Versatile Installation.

You save engineering time and transmitter cabinet space . . . and you save the cost of individual rectifier components with Moloney Unit Rectifiers.

Moloney Unit Rectifiers are available with vacuum tube, gas tube, or dry-plate rectifier elements. DC ratings from 2 KW through 10,000 KW and up — voltages of 1 KV through 250 KV and up — frequencies from 25 through 400 cycles and other special frequencies — and optional automatic or manual load-tap-changing equipment. *Specify Moloney.*

ME56-20



Write for Catalog SR 206 "HyperCores for Magnetic Components" and Catalog ST 3506 "Magnetic Components for Electronic Applications."

## M O L O N E Y   E L E C T R I C   C O M P A N Y

*Plate and Filament Transformers • Chokes • Unit Rectifiers • Modulation Transformers and Reactors • Pulse Transformers and Charging Chokes • HyperCores for Magnetic Components • Developmental Magnetic Components • Power and Distribution Transformers*

SALES OFFICES IN ALL PRINCIPAL CITIES • FACTORIES AT 5390 BIRCHER BLVD., ST. LOUIS 20, MO., AND TORONTO, ONT., CANADA

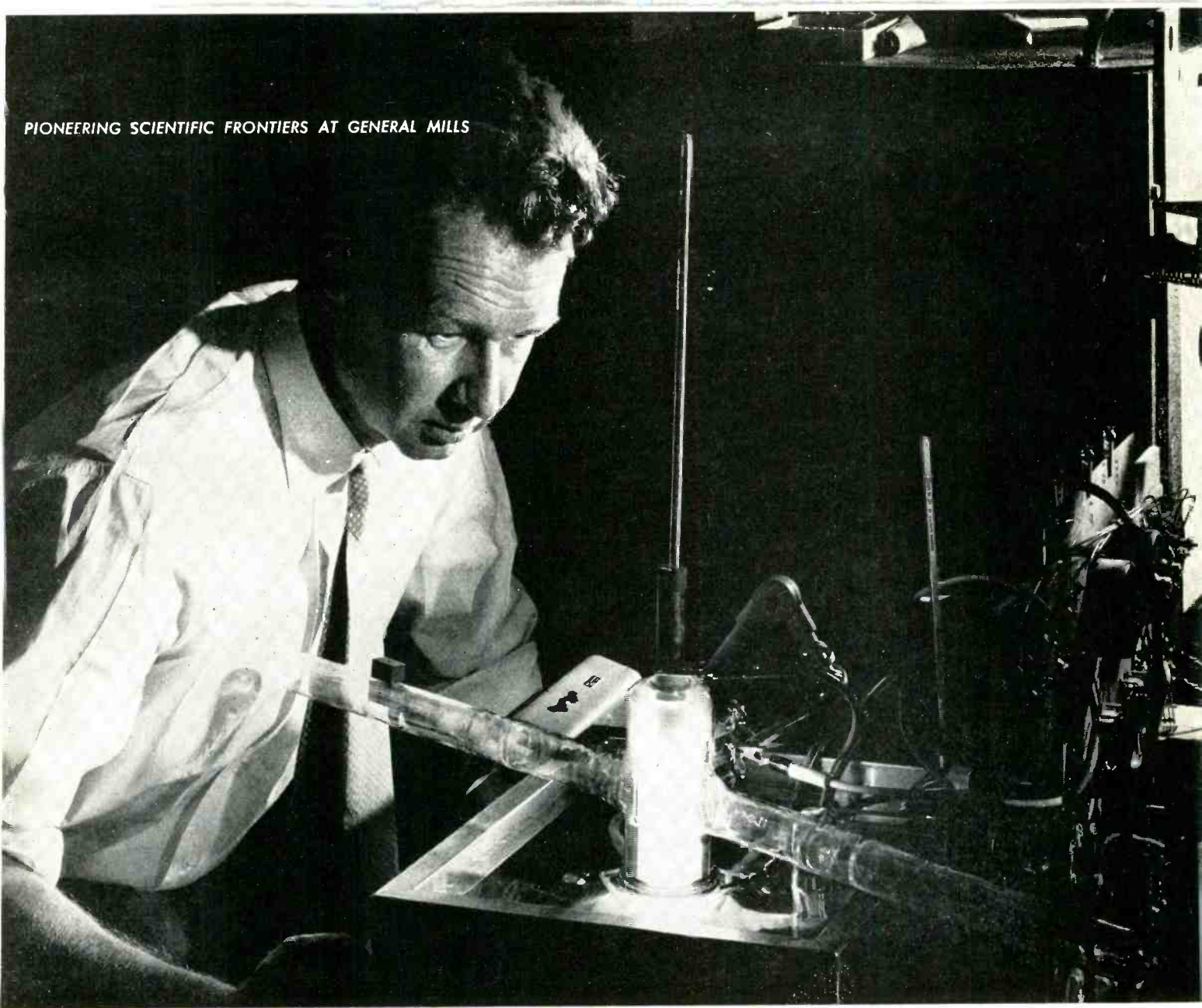

This scientific pioneer is Dr. G. K. Wehner, designer of the space chamber which he uses here to determine the "sputter-

ing" or disintegration rate of molybdenum under bombardment from atoms moving at 25,000 m.p.h., 200 miles above the earth.

## What happens to metals at 25,000 m.p.h. 200 miles up?

General Mills scientists are finding some of the answers to this question, which bears directly on space ships and man-made satellites.

Their findings indicate that materials to be sent into space must possess properties not found in today's ores and alloys. Since few new metals remain to be discovered, they conclude that present ones must be given new properties to cope with the heat barrier and to keep vehicles from disintegrating under particle bombardment.

The study of metals in space flight represents but a single phase of General Mills' over-all program of advanced

exploration in theoretical and developmental physics.

*Findings in this "research for tomorrow" are being translated regularly into practical applications for industrial and military use today. If you have product or production problems, you can profit from these applications, and from our high-level production facilities.*



### Send for Production Facts

This interesting booklet tells the story of how you profit by giving us your difficult production problems. Write Mechanical Division, Dept. EL10, General Mills, 1620 Central Ave. N. E., Minneapolis, Minn.

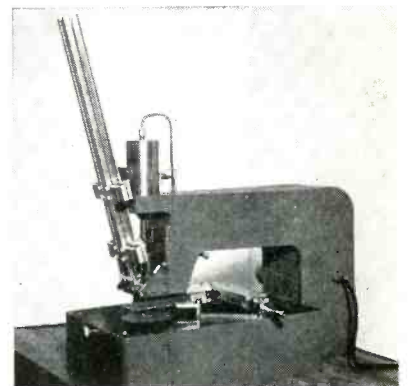

### AUTOFAB: built for the present

From General Mills' creative research and precision manufacturing come machines for industry to use today—machines such as *Autofab*, for near-automatic assembly of electronic components on printed circuit boards.

# MECHANICAL DIVISION OF General Mills

CREATIVE RESEARCH AND DEVELOPMENT + PRECISION ENGINEERING AND PRODUCTION

why companies find it  
**GOOD BUSINESS**  
 to specify panel instruments  
 by **Simpson...**

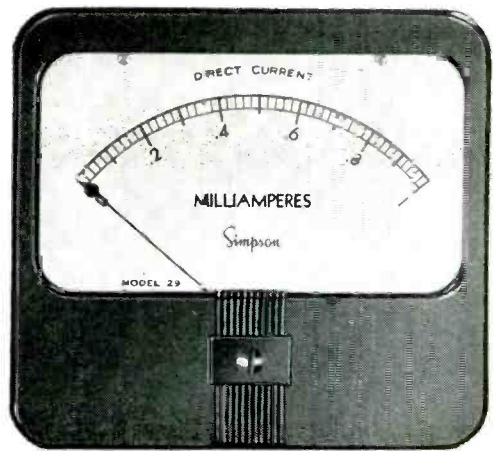

... **QUICK SERVICE** from  
**HUGE STOCKS!**

Over 50,000 stock units, in 800 sizes and types, are available for *immediate delivery* through 1,500 electronic distributors in the United States, Canada, and abroad. This wide distribution can save you time and prevent expensive delays.

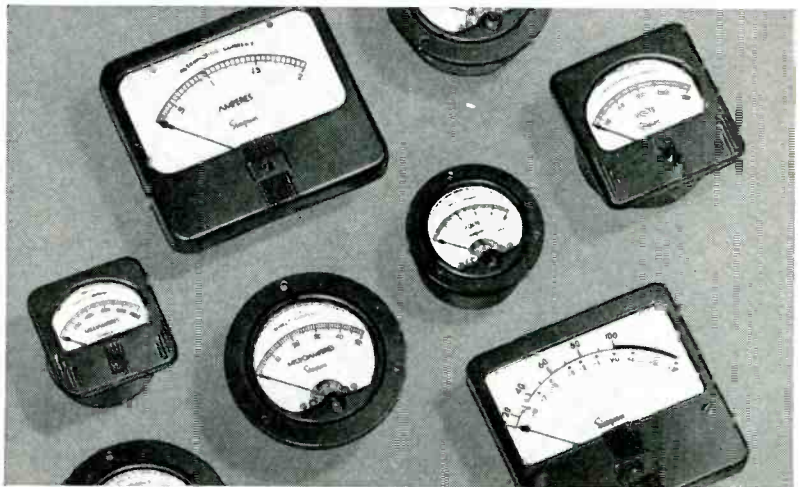

... **EXACT NEEDS**  
**CUSTOM BUILT!**

Many meters quickly built from *standing tools*. Others designed to your specifications. Delivery schedules on which you can rely. Movements include three sizes of Simpson's superb Core Magnet Meter Movement—*self shielded* and exceedingly rugged.

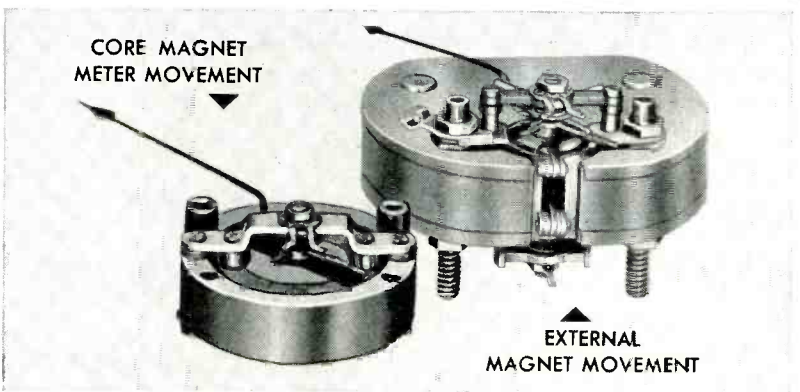

Ask your Simpson representative or write on letterhead for new Catalog now available.

Whatever your needs in panel instruments, you, too, will find it makes good business sense (and design sense) to specify "Simpson." Simpson instruments have established a reputation for laboratory accuracy . . . yet they have the ruggedness to stand up under years of service and severe shocks. Why not send us your panel instrument problems today?

*Instruments that stay accurate*

**SIMPSON ELECTRIC COMPANY**  
 5200 W. Kinzie St., Chicago 44, Illinois • Phone: EStebrook 9-1121  
 In Canada: Bach-Simpson Ltd., London, Ont.



# MERCATOR

Was our boy...

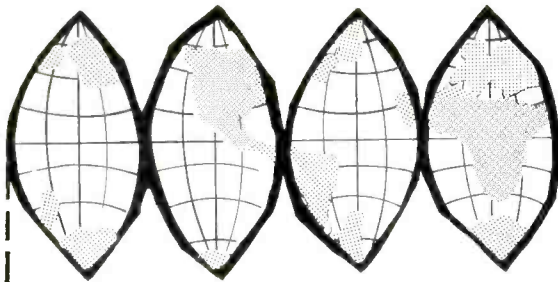

## Tower HORIZON Stretcher Makes the Earth FLAT, Too

It was for Gerhard Mercator, history says, to solve some mighty knotty 16th century navigational problems by accurately projecting the earth's curved surface onto a flat plane. Adventurous navigators needed more than crude maps to safely venture beyond their horizons. From the pen of this Flemish mapmaker came the "projection" method of chartmaking. On Mercator's drawing board is found the birthplace for the reliable maps and charts of modern navigation.

Just as sailors in Mercator's age needed a "flat" earth, so did communicators in this tv and microwave era. "Line-of-sight" transmissions no longer served our entire communication demands. Scatter Propagation held the challenge for electronic ingenuity. As part of the team working for Page Communications Engineers, Inc. on a Bureau of Standards project, TOWER was selected to engineer and fabricate one of the first successful High Gain Corner Reflector Antenna installations for trans-horizon microwave. TOWER continues to supply these critical installations in mass quantities. Whatever your communication problems, wherever they may be . . . depend on TOWER for creative engineering.

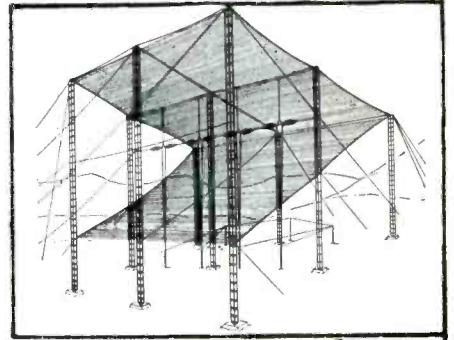

Write for free illustrated booklet

tower  
fabricators  
and erectors  
the world  
over

# TOWER

**CONSTRUCTION CO.**  
Sioux City, Iowa

Export Department  
431 Fifth Ave. New York City Ph: Murray Hill 5-3322 Cable: Artrocke, New York

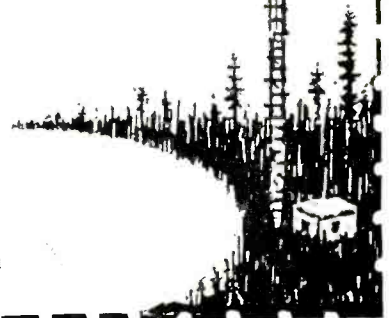

# "WE LIKE THE CONSISTENT QUALITY OF RICHARDSON PLASTICS"

SAYS.....



**CHICAGO TELEPHONE SUPPLY**  
*Corporation*



Exploded view shows a CTS control—a concentric shaft tandem variable resistor with switch. Arrows indicate laminated parts made with Richardson plastics.

## SIX PLANTS

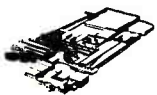

MELROSE PARK, ILL.



NEWNAN, GA.



OGDEN, UTAH

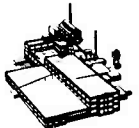

NEW BRUNSWICK, N. J.



INDIANAPOLIS, IND.



TYLER, TEX.

**RICHARDSON  
LAMINATED  
and MOLDED  
PLASTICS**

Chicago Telephone Supply Corporation is the world's largest producer of variable resistors. To achieve this position, they have stressed *quality*—both in their manufacturing operations and in their sources of supply. For many years, The Richardson Company has supplied the Chicago Telephone Supply Corporation with laminated and molded plastic products which meet their high standards for insulating and electrical properties—a testimonial to Richardson's own quality-mindedness.

If you are looking for a plastic supplier who can give you what you need, contact Richardson. Their complete laminating and molding facilities permit volume production with consistent high quality and accuracy. Write or phone today for complete information.

## The RICHARDSON COMPANY

FOUNDED 1858

2797 Lake St., Melrose Park, Illinois (Chicago District)

SALES OFFICES IN PRINCIPAL CITIES



# FOR QUALITY IN QUANTITY

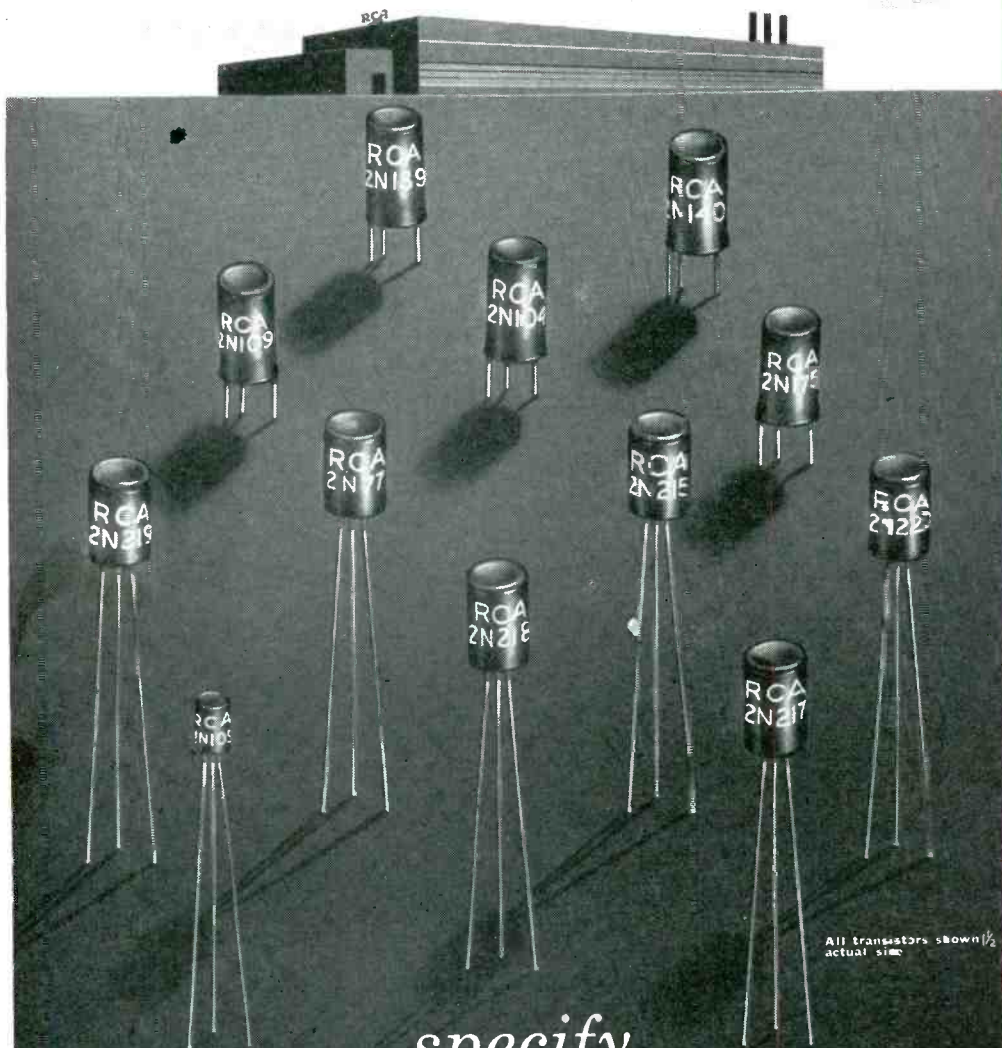

*specify*

## RCA TRANSISTORS

Whether you are a "ham," experimenter, service technician, or design engineer—building a rig, becoming familiar with transistors, replacing one in a set, or constructing a production prototype—you want exactly what RCA TRANSISTORS offer—high quality, long life, and uniformity of electrical characteristics. Because of the exceptional uniformity in characteristics of RCA transistors, each RCA TRANSISTOR of a type can be replaced with RCA transistors of the same type without need for circuit adjustments. Whether you need a few, one hundred, or one hundred thousand transistors—*for quality, specify RCA TRANSISTORS.*

AVAILABLE THROUGH RCA DISTRIBUTORS . . . NOW!



### TRANSISTORS

SEMICONDUCTOR DIVISION, SOMERVILLE, N. J.

**RCA-2N77** . . . For low-power audio-frequency amplifier service. Has flexible leads which may be soldered or welded into the associated circuits.

**RCA-2N104** . . . For low-power audio-frequency applications. Has a linotetral 3-pin base.

**RCA-2N105** . . . For low-power audio-frequency amplifier service where extremely small size is a requirement. Has flexible leads which may be soldered or welded into the associated circuits.

**RCA-2N109** . . . For class B push-pull power output stages of battery-operated portable radio receivers and audio amplifiers operating at power output levels of approximately 150 milliwatts. Has a linotetral 3-pin base.

**RCA-2N139** . . . For 455-Kc intermediate-frequency amplifier applications in transistorized portable radios and automobile radios. Has a linotetral 3-pin base.

**RCA-2N140** . . . For converter and mixer-oscillator applications in standard-AM-broadcast-band transistorized portable radios and automobile radios. Has a linotetral 3-pin base.

**RCA-2N175** . . . Low-noise type (6 db max.) for use in pre-amplifier or input stages of transistorized audio amplifiers operating from extremely small input signals. Has a linotetral 3-pin base.

**RCA-2N215** . . . Has same electrical characteristics as 2N104 but has flexible leads.

**RCA-2N217** . . . Has same electrical characteristics as 2N109 but has flexible leads.

**RCA-2N218** . . . Has same electrical characteristics as 2N139 but has flexible leads.

**RCA-2N219** . . . Has same electrical characteristics as 2N140 but has flexible leads.

**RCA-2N220** . . . Has same electrical characteristics as 2N175 but has flexible leads.

**NEW PLANT IN OPERATION** . . . To meet the ever-increasing demand for high-quality RCA TRANSISTORS, a new plant has been constructed at Somerville, N. J. It is equipped with the most modern production and inspection facilities to maintain RCA's high standards for quality.

# Riveting With a Hammer in Blind or Open Applications

Elimination of special riveting tools can mean faster production, lower costs, no down time.

J. K. BARRY, M. E.

The use of blind rivets installed with only an ordinary hammer from one side of the job offers a highly simplified method of fastening. Speed, convenience and *low installed cost* make Drive Riveting preferable not only for blind joints, but for fastening many parts that can be reached from either side.

The Southco Drive Rivet has a cored, slotted body with a grooved pin protruding from its head.

When the rivet is inserted through parts to be fastened, the pin is driven flush with the rivet head causing the expanding prongs to form a blind head behind the rear sheet. No further finishing is necessary, since the pin seats itself permanently to complete the smooth head contour.

Drive Riveting has five major advantages:

1. No investment in special tooling.

2. No lost time for tool repairs.
3. No limitation on the number of men who can install rivets.
4. Speed comparable to nailing.
5. Only one man is needed.

Widely used in truck bodies, storm doors, metal buildings and hundreds of other industrial applications, Southco Drive Rivets make a secure, vibration-proof joint. A wide range of head styles, diameters and grip lengths is available.

## RECOMMENDED APPLICATIONS FOR DRIVE RIVETING

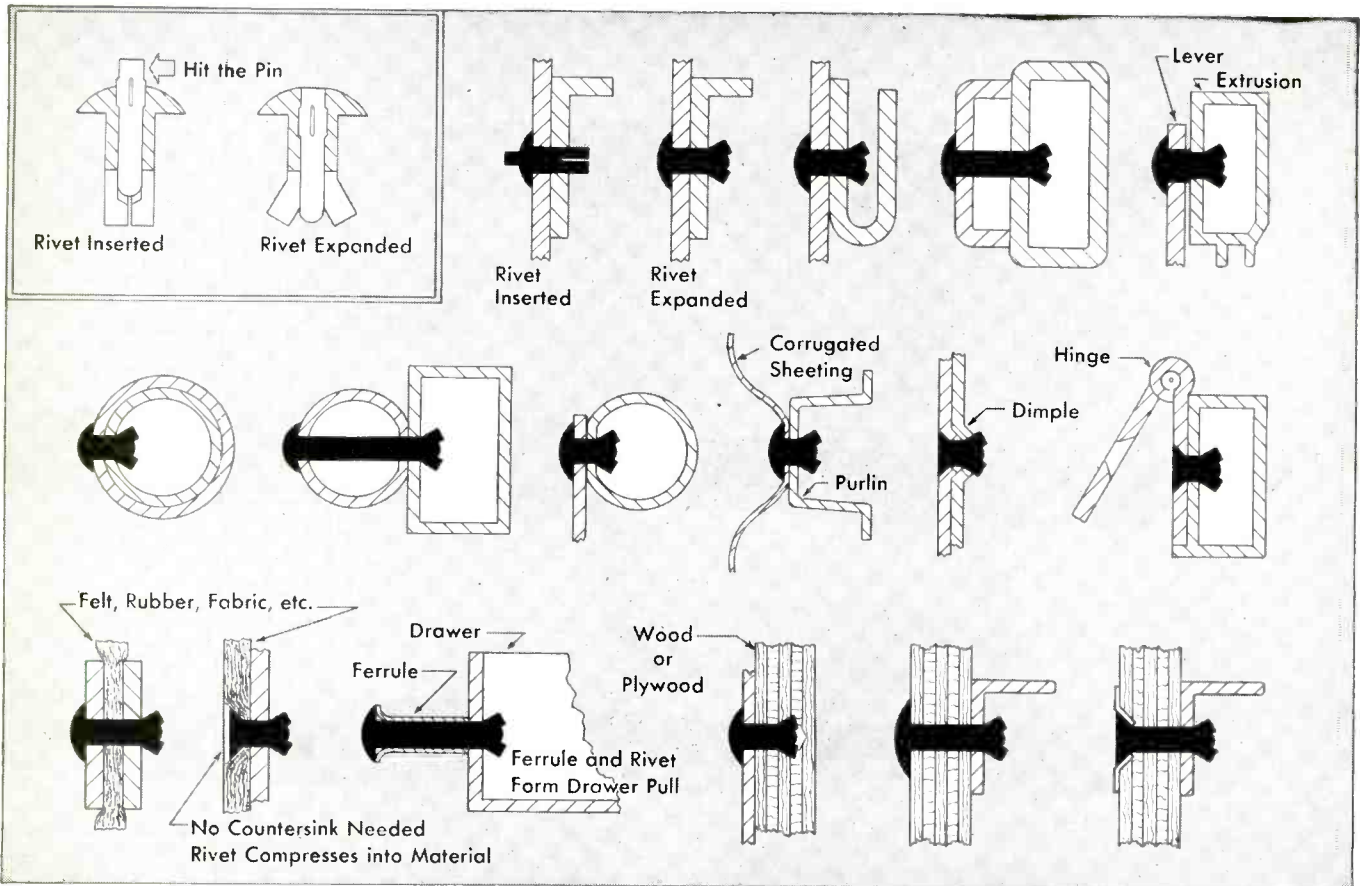

**SOUTHCO FASTENERS**  
 ©1956 **LION**

Southco Div., South Chester Corporation

233 Industrial Highway, Lester, Pa.

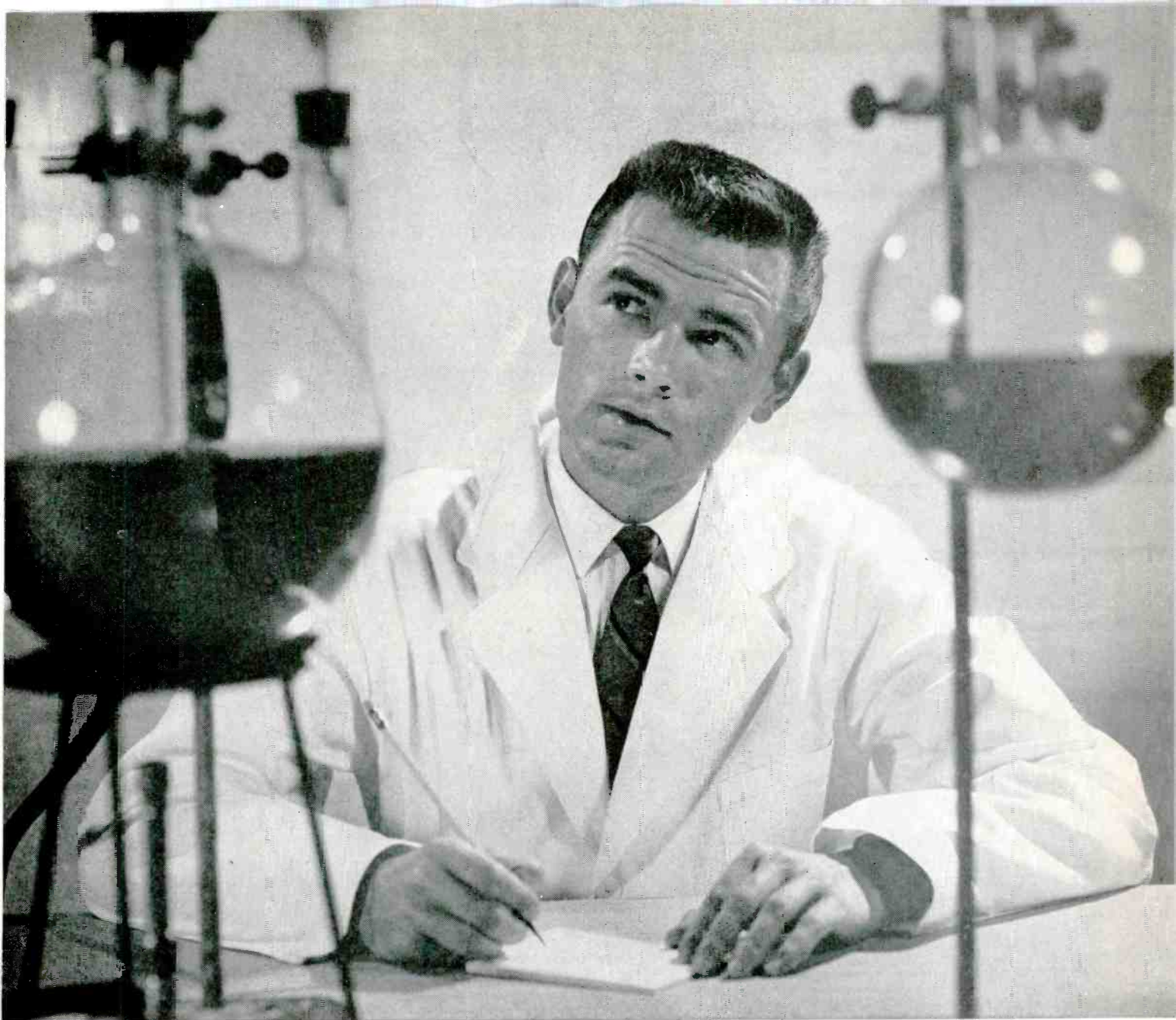

*When electrical grade molding compounds are evaluated...*

## **RESINOX\* 3700**

**is the standard of comparison**

"Thirty-Seven Hundred" is the leading electrical grade molding material because it was planned *in-the-field*—developed by Monsanto research to match a bill of particulars set up by Monsanto's technical engineers calling on molders of critical electrical control parts.

**What these engineers said in effect was this:** The electrical industry needs a high-performance molding material for magneto ignitions, motor control and transmission circuits, and other critical applica-

tions. They want high arc resistance combined with unusual dimensional stability... minimum after-shrinkage... moldability... superior heat resistance, impact resistance, mechanical strength. These properties were desired without any relative increase in price.

**Result:** Resinox 3700.

For complete information on Resinox 3700, write to Monsanto Chemical Company, Plastics Div., Dept. 409, Springfield 2, Mass.

*And in case  
after case,  
"THIRTY-SEVEN  
HUNDRED"  
gets the job!*

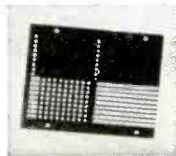

\*RESINOX: REG. U. S. PAT. OFF.



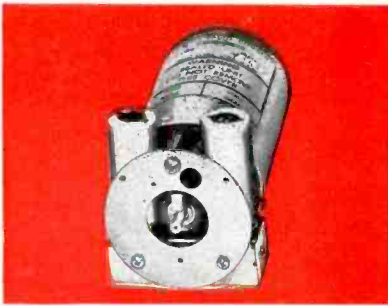

### PERMEABILITY-TUNED VFO's (Mfd. by Collins Radio Co.)

Mechanically stable—sealed against atmospheric changes—temperature and voltage compensated. Available as complete packages for incorporation into your equipment. Superior accuracy, stability and linear dial calibration for your transmitters, receivers, test equipment or frequency standards.

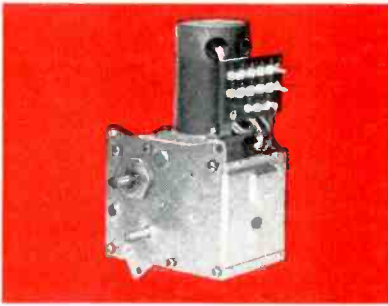

### AUTOTUNES (Mfd. by Collins Radio Co.)

Electro-mechanical position systems. Ideally suited for components requiring rotary or linear motion. Positioning accuracies of 0.05 angular degrees with reset accuracy to 0.0001 inch relative to 1/4 inch shaft size. Designed for the lifetime of any equipment. Fast—versatile—high torque—accurate—dependable.

SEE  
YOUR  
C-A-C MAN

NEW YORK—H. Gray Assoc. YE 2-3825  
21-10 33rd Rd. Long Island City 6, N. Y.  
PHILADELPHIA—C. R. Hille Co. Elgin 6-2266  
Hillview Road, Box 144, Paoli, Pa.  
BALTIMORE—C. R. Hille Co. Northfield 5-4500  
L. G. Korman, 3006 Kenwood, Baltimore 6, Md.  
CHICAGO—Cassner & Clark Co. Rogers Pk. 4-6121  
6644 N. Western Ave., Chicago 45, Ill.  
LOS ANGELES—S. O. Jewett, State 9-6027  
13537 Addison St., Sherman Oaks, Calif.  
SYRACUSE—Naylor Elec. Co., 2-3894  
1115 Hills Bldg., Syracuse 2, N. Y.  
MERIDEN—H. Lavin Assoc. Beverly 7-4555  
H. Lavin, P.O. Box 196, Meriden, Conn.  
NEEDHAM—H. Lavin Assoc. 3-3448  
R. V. Curtin, 82 Curve St., Needham, Mass.

CLEVELAND—E. Kohler Assoc. Olympic 1-1242  
8905 Lake Ave., Cleveland 2, O.  
DAYTON—Ernie Kohler Assoc. OXmoor 2813  
2600 Far Hills Ave., Dayton 9, O.  
SEATTLE—Testco Mohawk 4895  
D. Thompson, Boeing Field, Rm. 105, Seattle 8, Wash.  
INDIANAPOLIS—R. O. Whitesell & Assoc.  
Fleetwood 9-5374  
6620 East Washington, Indianapolis 1, Ind.  
DALLAS—Norvell Assoc. Forest 8-4180  
5622 Dyer Street, Dallas 6, Tex.  
ST. PAUL—Northport Engineering, Inc.  
Midway 4-7884  
186 N. Fairview St., St. Paul 4, Minn.  
ST. LOUIS—E. W. McGrade Co. Parkview 5-6550  
1110 South Brentwood, St. Louis 17, Mo.

## COMMUNICATION ACCESSORIES CO.

World's Largest Exclusive Producer of Toroidal Windings

HICKMAN MILLS, MISSOURI • PHONE KANSAS CITY, SOUTH 1-6111

A Subsidiary of Collins Radio Company

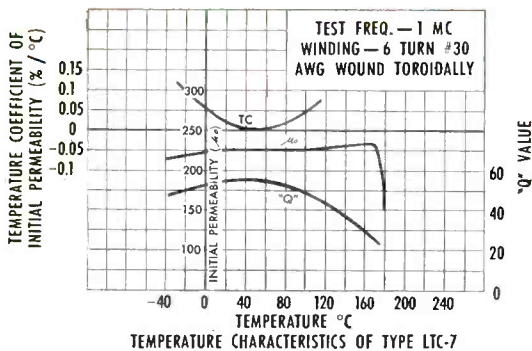

### FERRITE CORES (Mfd. by Collins Radio Co.)

Requirements for extreme temperature stability and consistently reproducible cores encouraged the Collins Radio Company to enter the magnetic materials field. Now, after several years of intensive research and development, these cores are available through CAC in many standard or custom forms for all applications. Temperature characteristics developed exhibit 10 times improvement over previous materials. Special saturation and other properties are presently available. Technical bulletins upon request.



### TUBE SHIELDS (Mfd. by Collins Radio Co.)

Heat treated beryllium copper corrugated liner and socket insert are highly resilient and accommodate wide variations of tube diameter. Base liner reduces bulb temperature in most critical tube area. Interchangeable with standard JAN equipment. Tube cannot work out of socket through long term vibration. Maximum electrostatic shielding.

Catalogs on Individual Components are Available on Request.



**THE MARCONI  
S.H.F.  
WAVEMETER  
Type TF 1059**

**ACCURACY 5 PARTS IN  $10^4$ ...  
and rugged!**

The Marconi TF 1059 is a 4-10 KMC cavity wavemeter in which ruggedness and dependability take equal place with high accuracy. The resonating system with its precision-built micrometer tuning is guarded from knocks and dust by total enclosure in a conventional instrument case. Micrometer adjustment is by means of a panel knob and friction drive; micrometer setting is viewed through a port incorporating a magnifying lens. The meter, which responds to inputs as low as 1 mw, is protected against overload by a cut-out relay. A coaxial input connector, a sensitivity control, and terminals for coupling to an extra-sensitive external meter, are further features contributing to the all-round utility of the Marconi TF 1059.



**SPECIFICATION**

FREQUENCY RANGE  
4 to 10 KMC

ACCURACY  
0.05%

DISCRIMINATION  
0.02 to 0.03%

SENSITIVITY  
A meter reading of greater than 15% f.s.d. is obtained for 1 mw input.

**MARCONI  
INSTRUMENTS**

*Marconi—since 1897*

44 NEW STREET · NEW YORK 4

CANADIAN MARCONI COMPANY  
6035, COTE DE LIESSE,  
MONTREAL 9, CANADA

HEAD OFFICE: MARCONI INSTRUMENTS LTD., ST. ALBANS, HERTS., ENGLAND

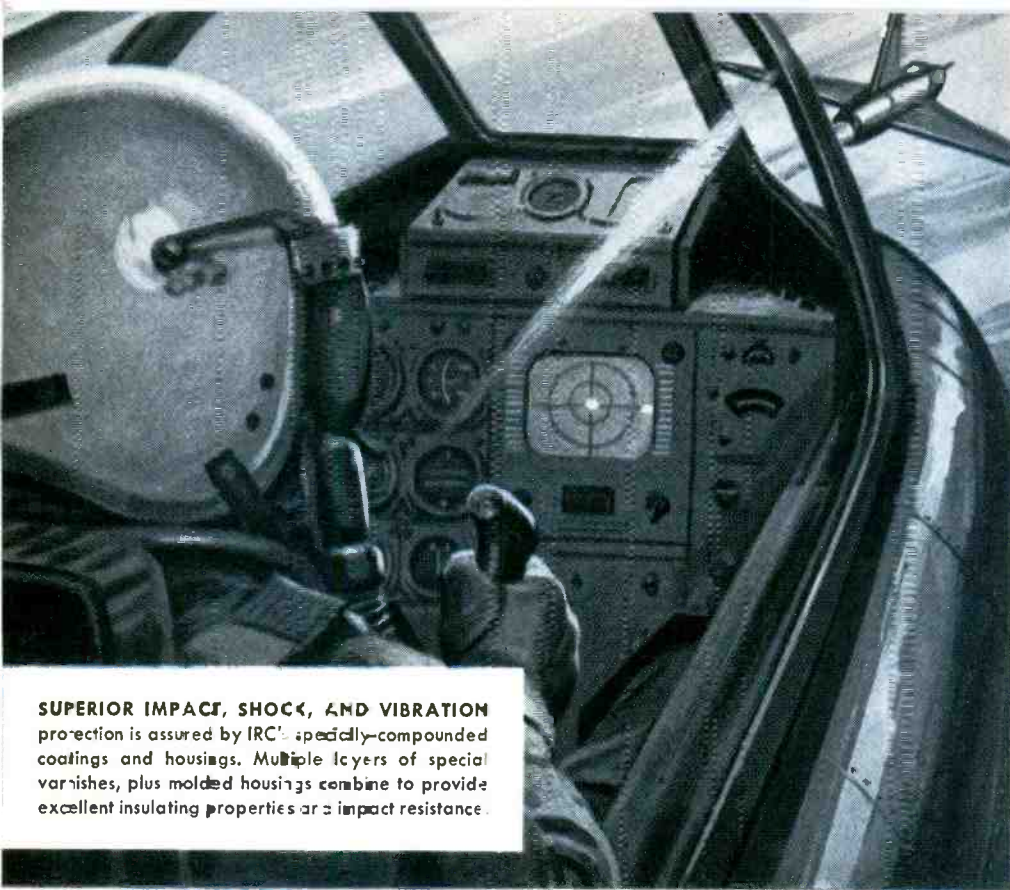

**SUPERIOR IMPACT, SHOCK, AND VIBRATION** protection is assured by IRC's specially-compounded coatings and housings. Multiple layers of special varnishes, plus molded housings combine to provide excellent insulating properties and impact resistance.

In a sense, a resistor is simply a mechanical device for packaging ohms. So it's easy to see why the materials entering into the mechanical package are extremely important to resistor performance. That's why more than one-third of the 200 technicians at IRC are occupied in developing insulating coatings and housings that give *extra* protection

## Extra **IRC**<sup>®</sup> resistor protection pays off ...but you pay no more for it!

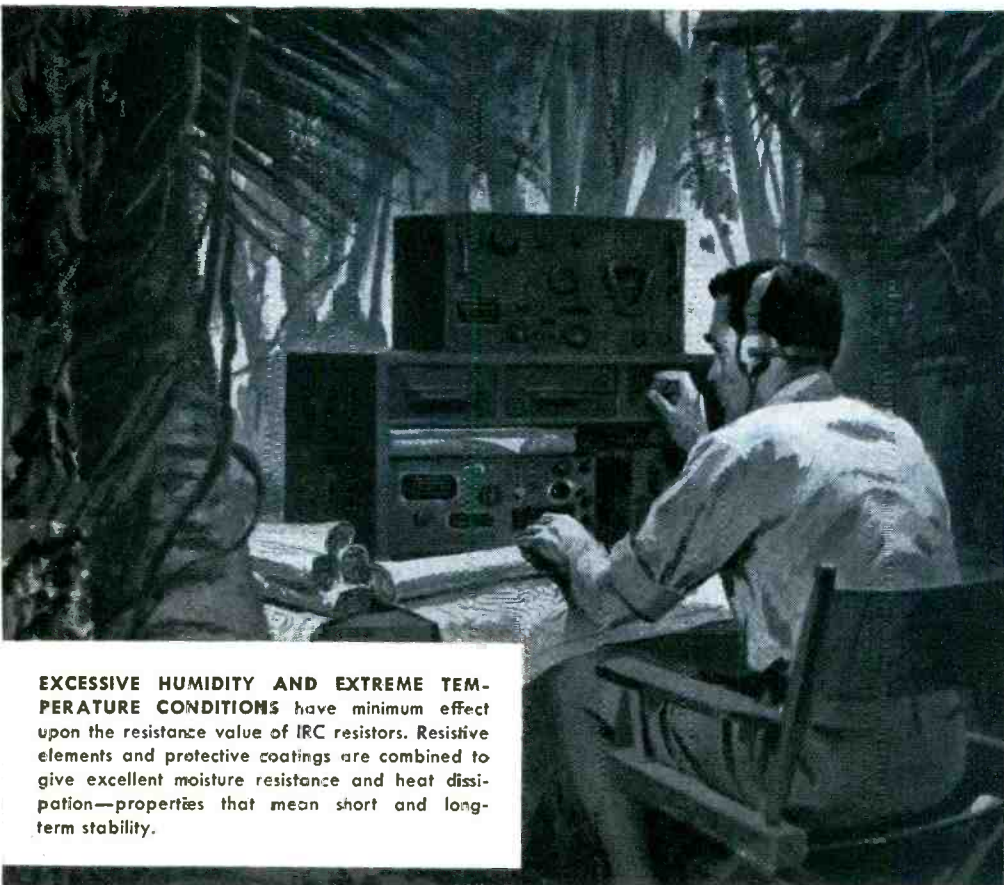

**EXCESSIVE HUMIDITY AND EXTREME TEMPERATURE CONDITIONS** have minimum effect upon the resistance value of IRC resistors. Resistive elements and protective coatings are combined to give excellent moisture resistance and heat dissipation—properties that mean short and long-term stability.

against mechanical damage, humidity effects, and temperature variations.

Out of this never-ending activity come coatings and molding compounds that are custom-tailored for each and every type of resistor. As a result, every IRC resistor gives far more protection from damage and ambient conditions than any other of its type!

# How IRC resistors give added protection

## molded resistors



TYPE BT Fixed  
Composition Resistor



TYPE PW TYPE BW  
Insulated Wire  
Wound Resistors



TYPE MB TYPE MD  
Mailed Deposited and  
Boron Carbon Resistors



TYPE CL  
Insulated  
Wire Wound Chokes

Plastic compounds used in IRC molded resistors are all specified by IRC to combine excellent insulating properties, moisture resistance, and impact resistance.

## varnish coated resistors



TYPE DC TYPE BO  
Deposited and Boron  
Carbon Resistors



TYPE MV High  
Voltage Resistor



TYPE MP High  
Frequency Resistor



TYPE HFR High  
Frequency Resistor

Where mechanical damage isn't a major problem, IRC resistors give excellent protection at lower cost through the use of IRC-developed varnish coatings. Because several layers are applied and cured under specially controlled conditions, these resistors offer superior humidity and temperature characteristics.

## cement insulated resistors



TYPE PWW TYPE FRW  
Power Wire  
Wound Resistors



TYPES PW-5, 7 and 10  
Small Insulated  
Power Resistors

The special cement coatings used to insulate IRC power resistors give excellent mechanical protection. Type PWW Resistors, for example, withstand a transverse pressure of 25 pounds. These exclusive IRC cements also permit maximum heat dissipation and give superior moisture protection.

## impregnated and encapsulated resistors



TYPE WWJ Precision  
Wire Wound Resistor



SERIES "PH"  
Encapsulated Precision  
Wire Wound Resistor

Type WWJ Resistors feature a special compound that thoroughly impregnates the winding and remains stable at varying temperatures. This compound not only gives maximum mechanical protection, but also serves as an insulating barrier and minimizes moisture effects. In IRC encapsulated resistors, the same epoxy resin is used for both the core and the outer housing, thus minimizing the effects of expansion and contraction due to various temperature conditions. This epoxy resin also imparts excellent insulating and moisture-resistant properties to the housing.

Insulated Composition Resistors • Deposited and Boron Carbon Resistors • Power Resistors • Voltmeter Multipliers • Ultra HF and Hi-Voltage Resistors.

Wherever the Circuit Says

Low Wattage Wire Wounds • Resistance Strips and Discs • Selenium Rectifiers and Diodes • Hermetic Sealing Terminals • Insulated Chokes • Precision Wire Wounds.



HYCOR, Division of International Resistance Co., Sylmar, Los Angeles County, California

Subsidiaries:

Circuit Instruments Inc., St. Petersburg, Florida  
Hycor Company, Inc., Vega Baja, Puerto Rico

## INTERNATIONAL RESISTANCE COMPANY

Dept. 234, 401 N. Broad St., Philadelphia 8, Pa.

In Canada: International Resistance Co., Ltd., Toronto, Licensee

Please send technical bulletins describing  Fixed Compositions  Deposited and Boron Carbons  Low Power Wire Wounds  Power Wire Wounds  High Voltage Types  High Frequency Types  Insulated Chokes  Precision Wire Wounds  Encapsulated Precisions

Name \_\_\_\_\_

Company \_\_\_\_\_

Address \_\_\_\_\_

City \_\_\_\_\_ State \_\_\_\_\_

NOW E-I OFFERS  
THE COMPLETE GRAPHIC DATA  
HANDLING LINE...

# 3 NEW *x-y recorders*

plus a COMPLETE line  
of ACCESSORIES!

Every operating convenience possible has been built into these new E-I X-Y Recorders to provide maximum simplicity of control and ease of maintenance.

In addition, numerous performance features such as freedom from jitter, isolated inputs, automatic pen lift, vacuum hold-down, high-performance servos, and sensitivities from 0.5 mv per inch to 50 volts per inch provide performance excellence found in no other recorders.

Models are available for general-purpose recording, data handling, and analog computer recording and function generations. Ask your E-I representative for the complete story.

All models available for standard rack mounting. 11x17" instruments may be used in standard cabinet or rack mounted — without changing metalwork!

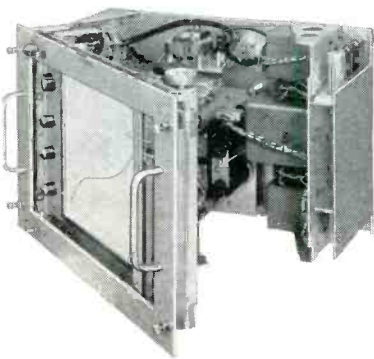

Accessories include: Curve follower (Model 210), Card-Tape Converter (Model 150), Keyboard (Model 175), and Symbol Generator (Model 250).

# 1



### model 100

8½ x 11", flatbed, or rack mounted  
0.25% accuracy  
½-second full scale pen speed  
11 scale ranges, 5 mv to 500 v full scale  
200,000 ohms-per-volt input impedance

# 2

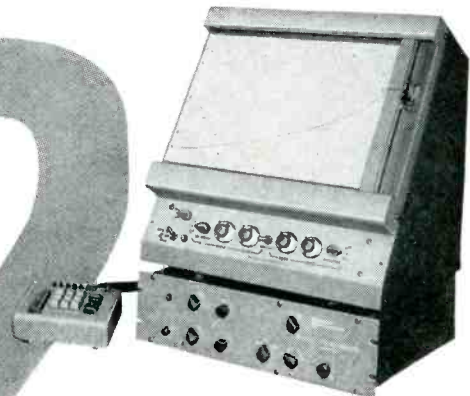

### model 200

11 x 17", flatbed  
±0.15% of full scale accuracy  
20" per second slewing pen speed  
3 scales; 0.1 v, 1.0 v, 10 v per Inch  
scale and zero potentiometers  
with in-line dials  
1 megohm input resistance

Shown with Keyboard (Model 175)  
and Symbol Generator (Model 250)  
10-key keyboard  
six electrically selected characters  
complete operational controls

# 3

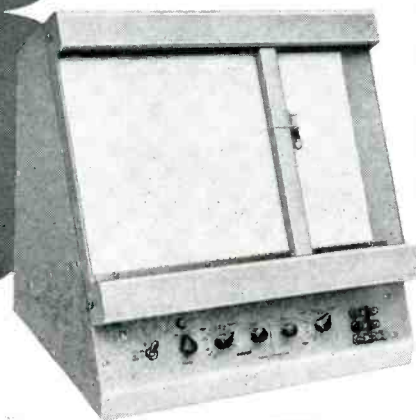

### model 225

11 x 17", flatbed  
±0.2 full scale accuracy  
20" per second slewing pen speed  
built-in electronic reference  
16 scale ranges, 0.5 mv to 50 v per inch  
200,000 ohms-per-volt input impedance

**ELECTRO  
INSTRUMENTS  
INC.**

3794 Rosecrans Street, San Diego 10, California



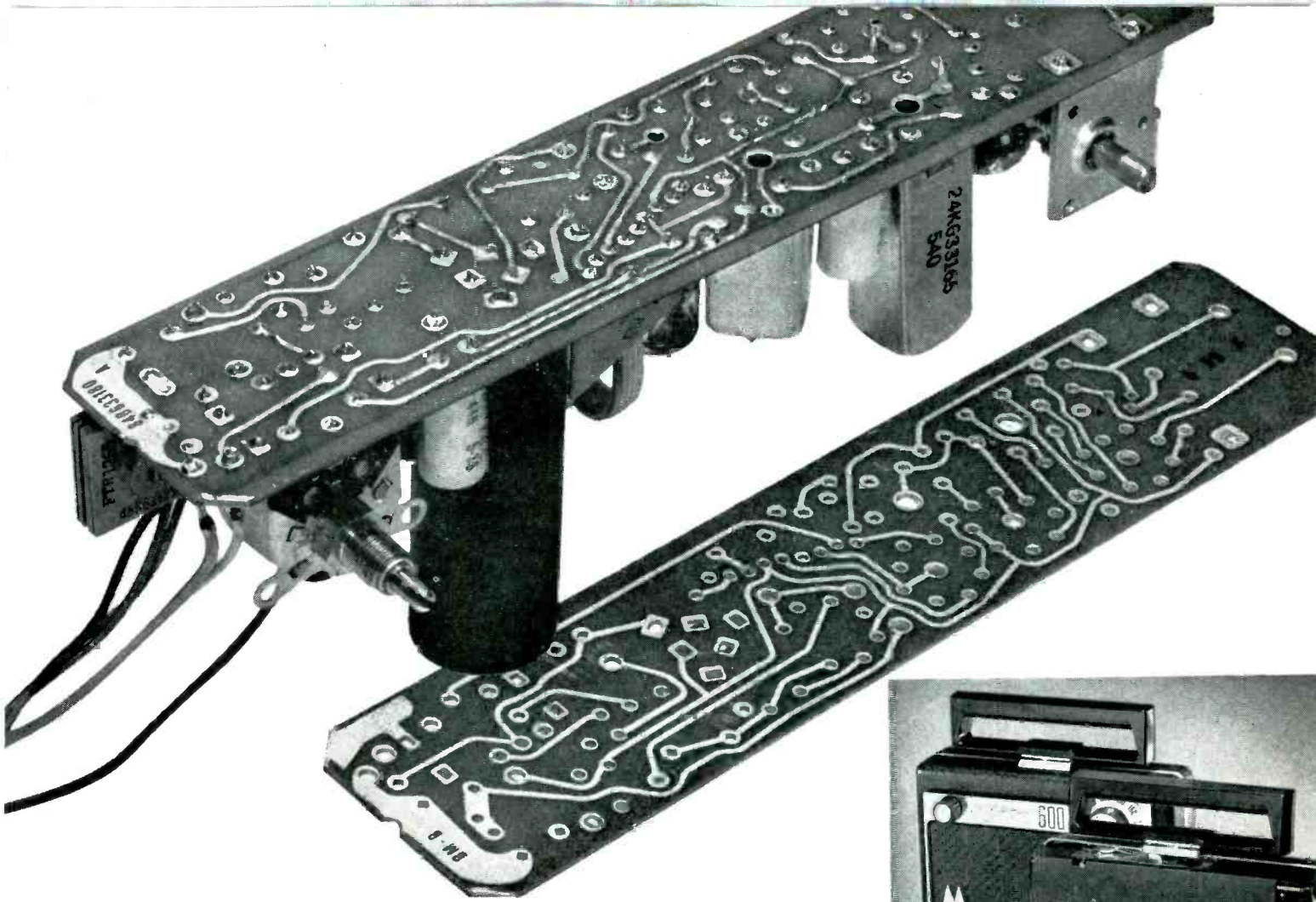

# What this resin does for Motorola's plated circuits

- ... gives a good base for bonding of copper firmly to the laminate
- ... provides high insulation resistance and low dielectric loss
- ... forms a translucent laminate permitting easy checking of reverse side circuit alignment
- ... withstands 500° F. heat of dip-soldering
- ... results in a lamination that exceeds U. S. Government standards and NEMA specifications.

All these advantages are found in BAKELITE Brand Phenolic Resin CLSA-3914, a superior hot punch laminating varnish used in the Motorola "Ranger" portable radio shown here. When high surface resistance is needed, CLSA-3914 is used on paper stock pre-treated with 12 to 16 per cent of a water-miscible resin, such as BAKELITE Phenolic Resin BLL-3913. Both XXXP and XXXP-1R grade laminates are produced by this method.

Technical information on BAKELITE Laminating Varnishes made especially for printed circuits is available by writing Dept. SO-50.



The Motorola "Ranger" achieves compact, sturdy construction and fast assembly with plated circuits on laminated stock produced by **Farley & Loetscher Mfg. Co.**, Dubuque, Iowa, using BAKELITE Laminating Varnishes.



**BAKELITE COMPANY**, A Division of Union Carbide and Carbon Corporation **UCC** 30 East 42nd Street, New York 17, N. Y.  
The term BAKELITE and the Trefoil Symbol are registered trade-marks of UCC



# CAPACITORS

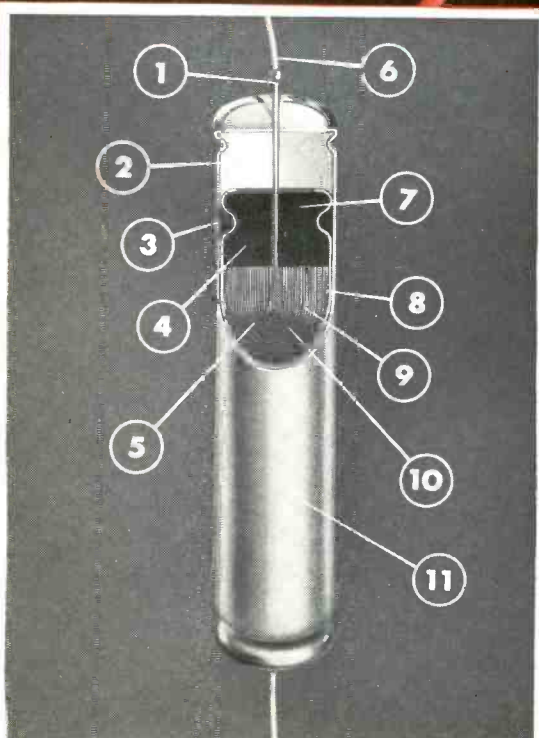
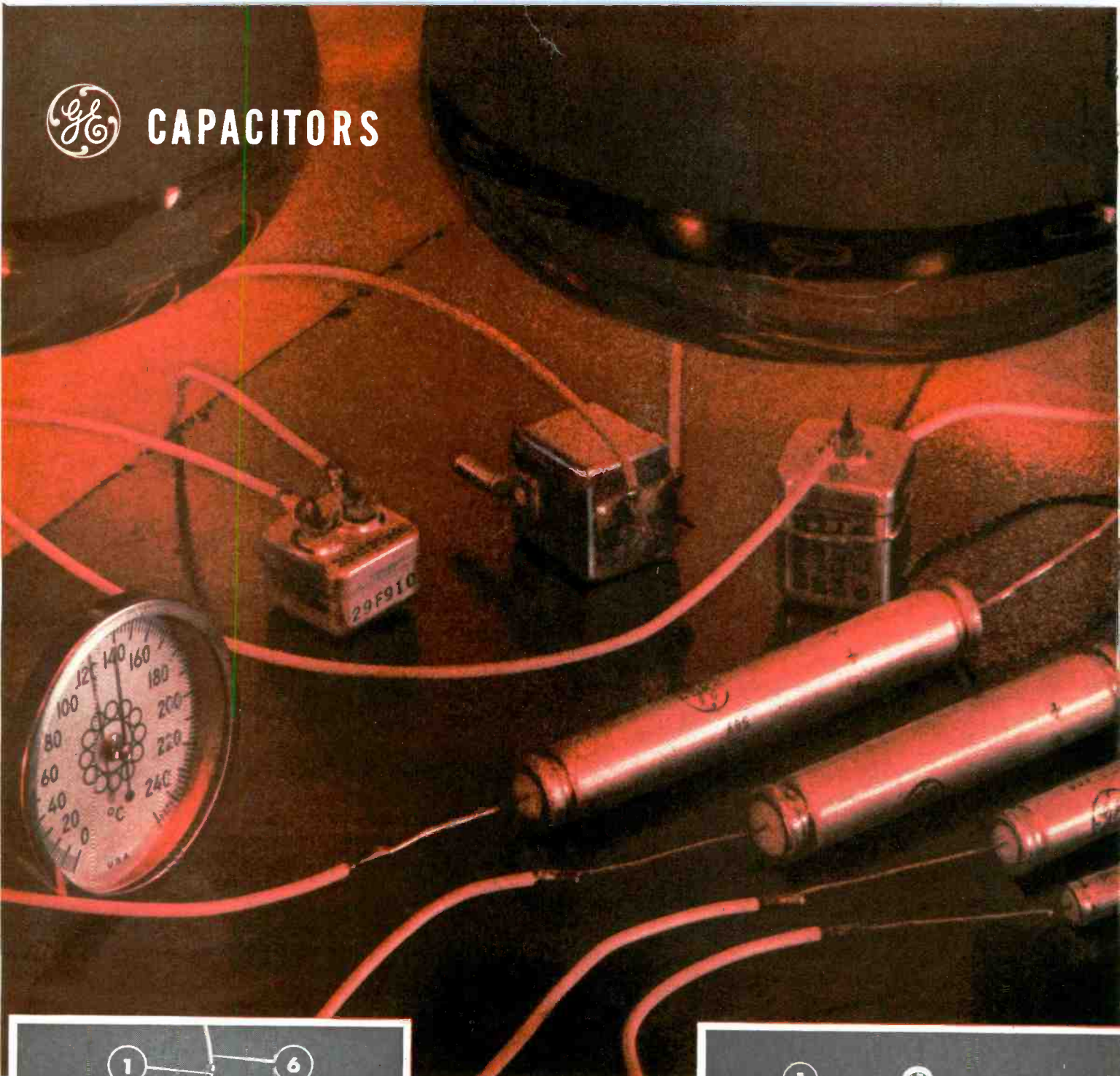

**HIGH TEMPERATURE TANTALUM CAPACITOR — TUBULAR —** features:  
 1 — Tantalum lead, 2 — Teflon\* bushing, 3 — Mylar\* insulating sleeving, 4 — Insulation, 5 — Paper and tantalum foil roll, 6 — Solderable nickel lead, 7 — Rubber bushing, 8 — Double metal case construction, 9 — Non-acid electrolyte, 10 — Plain and etched foil, 11 — Polar or non-polar construction.

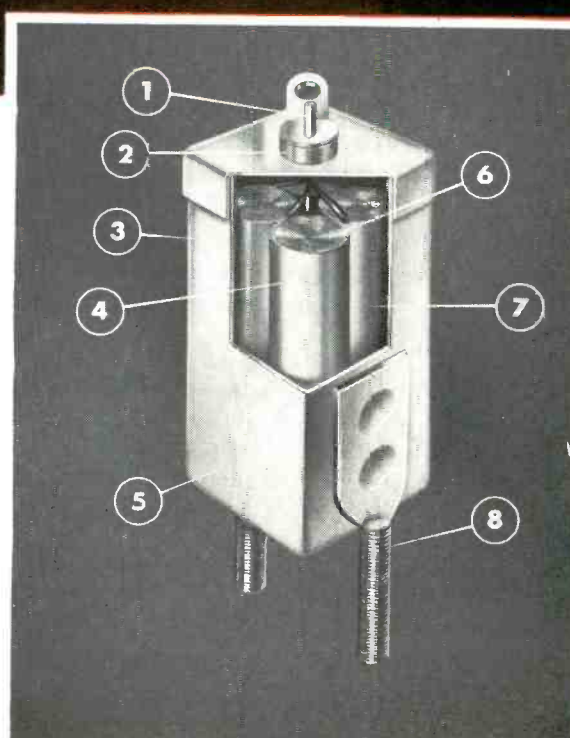

**HIGH TEMPERATURE TANTALUM CAPACITOR — RECTANGULAR —** features:  
 1 — Tantalum stud, 2 — Silicone bushing, 3 — Polar or non-polar construction, 4 — Paper and tantalum foil rolls, 5 — Silver-plated metal case, 6 — Plain and etched foil, 7 — Non-acid electrolyte, 8 — Mounting stud (optional).

\*DuPont Co. Trade Mark

# General Electric Tantalytic\* capacitors operate at +125 C ambient

## for 1000 hours at full rated voltage

To help you solve difficult space problems in design functions demanding high reliability miniaturized equipment capable of operating in ambient temperatures ranging from -55C to +125C at full rated voltage, General Electric offers a variety of shapes and sizes of high temperature Tantalytic capacitors.

The Tantalytic capacitor is built for at least 1000 hours operation at +125C with no more than 20% loss in capacity. Below +125C, capacitor life is extended in proportion to the reduction in ambient temperature.

Whatever your capacitor requirements might be, there is a General Electric sub-miniature capacitor for most applications. Take, for example, the metal-clad tubular capacitor — mineral oil impreg-

nated, built to MIL-C-25A — often applied to "work horse" applications in military electronic circuits. Or, capacitor pulse forming networks, adhering to strict capacitance tolerance and temperature range, are engineered for missiles and radar equipment.

New permafil capacitors, built to meet the characteristic "K" requirements of MIL-C-25A, are now available in rectangular case styles. These solid dielectric capacitors can withstand the violent shock and vibration found in today's missile and airborne electronic systems.

For assistance with capacitor applications contact your General Electric Apparatus Sales Engineer or write to the General Electric Company, Section 442-40, Schenectady 5, New York.

\*Registered Trade Mark of General Electric Co.

*Progress Is Our Most Important Product*

# GENERAL ELECTRIC



**METAL-CLAD TUBULAR CAPACITORS**— +85C, mineral oil impregnated. Built to MIL-C-25A. Ratings: .001 to 1.0 uf, 100-600 v. d-c. Tol:  $\pm 5\%$ ,  $\pm 10\%$ , or  $\pm 20\%$ . Write for GEC-1390.

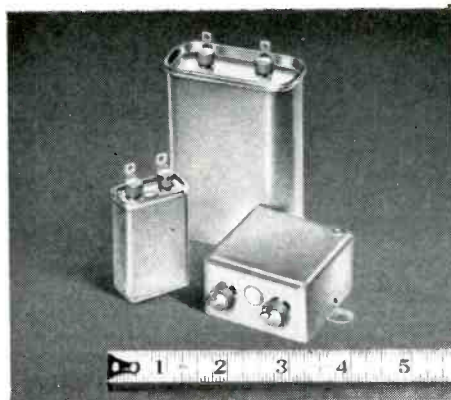

**PERMAFIL RECTANGULAR** solid dielectric in case styles CP50, CP60, and CP70 series. Built to electrical requirements of characteristic "K", MIL-C-25A. Ratings: .01 uf to 10 uf, 100 v. d-c to 1500 v. d-c, Temp. range: -55C to +125C.

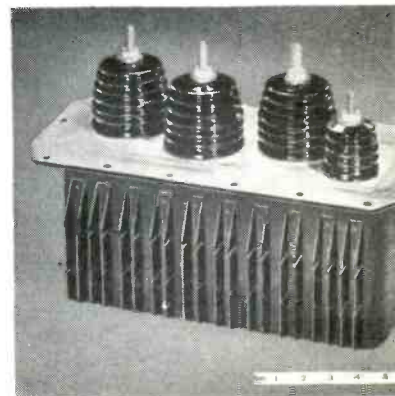

**CAPACITOR PULSE FORMING NETWORKS** — for missiles and radar equipment. Capacitance tolerance: +7% (at +25C). Temp. range: -55C to +125C. Write for GEA-4996.

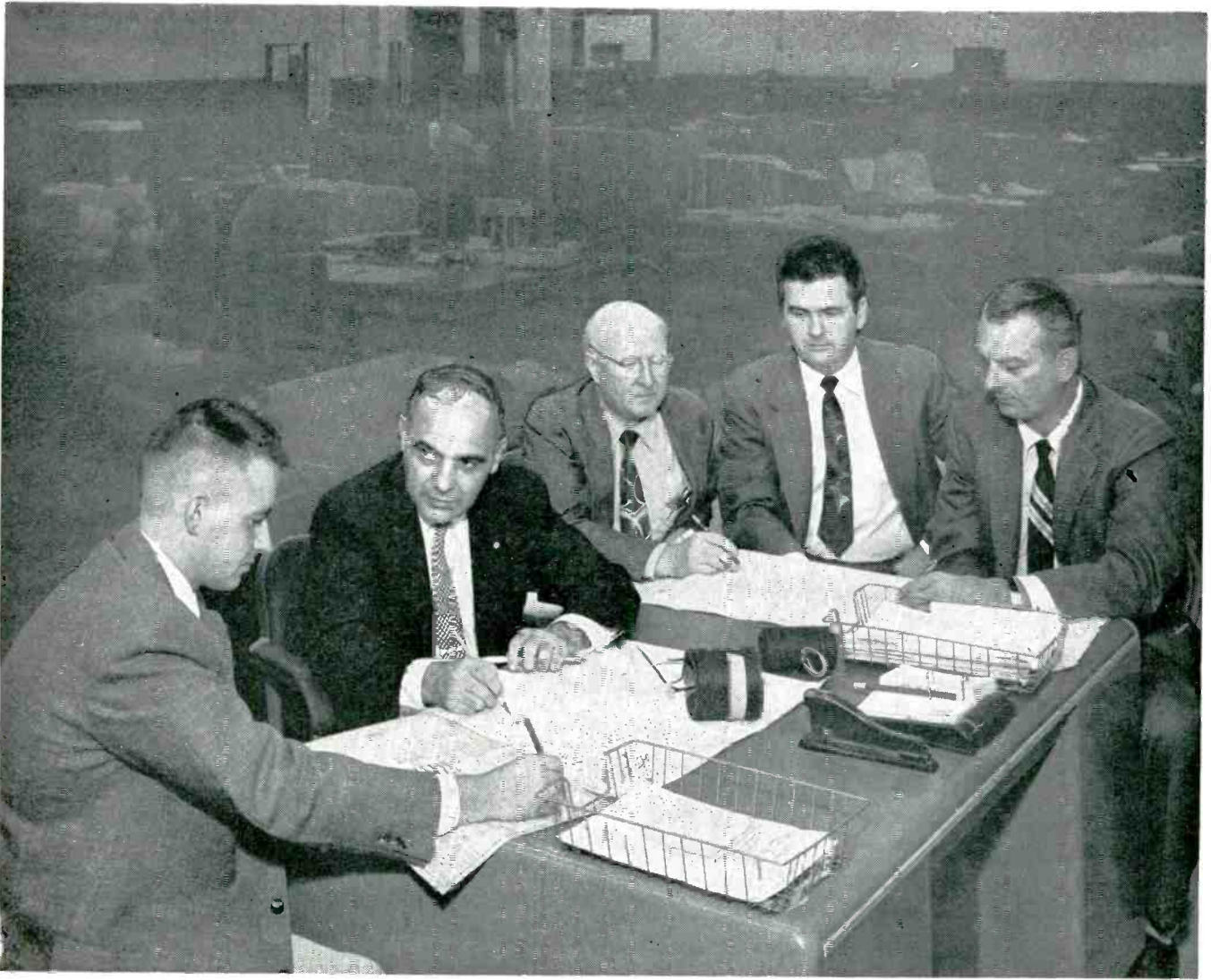

## What's **YOUR** Dynamotor Problem? problem-solving is our specialty here at Wincharger



for guidance,  
 fire control,  
 radar, homing,  
 transceivers  
 and  
 telemetering

**W**HEN a vital Defense establishment recently needed to develop a new power supply unit for a major project, they came to Wincharger's engineers with the job. We are already delivering production units, and the Defense agency is frankly delighted with both the design and the production.

Do **YOU** have a special application with special problems of vibration, altitude, heat, shock, humidity, regulation?

Wincharger's Chief Engineer and his section heads like nothing better than solving such problems.

They feel, in all modesty, that they know more about Dynamotors than anybody else in the world! They have some justification for this confidence, because they have been demonstrating a remarkable understanding of Dynamotors for many years.

You might ask somebody—just about any leading name in the electronics industry—about Winco engineering. Then send us a letter or phone us, outlining your requirements in electrical and mechanical characteristics, and your special problem. You will be well on the way to having it out of your hair.

**Manufactured by WINCHARGER CORPORATION . . . Sioux City, Iowa**  
Subsidiary of the Zenith Radio Corporation.

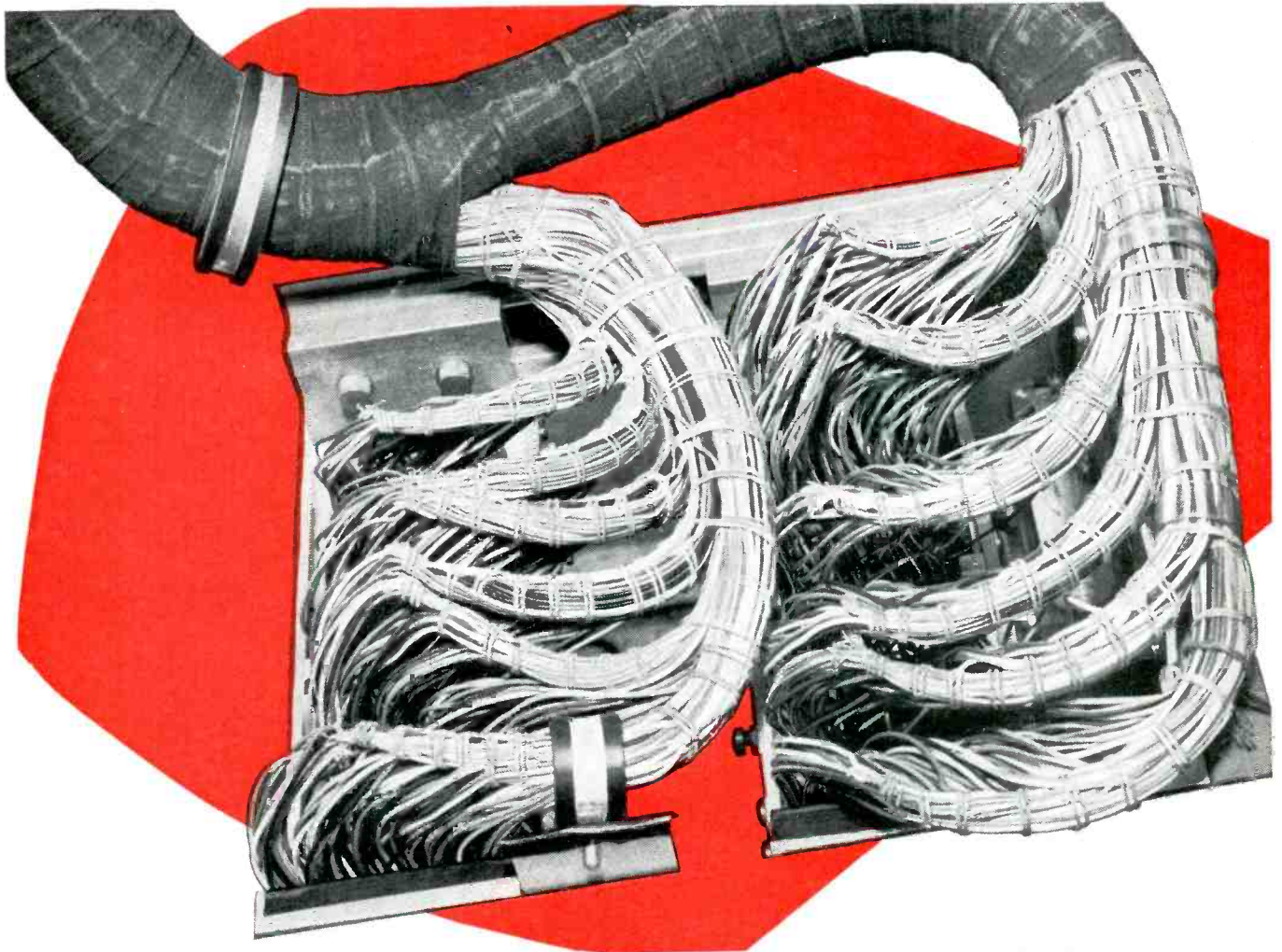

## Here's One Reason Why You Should Know About AMP Terminals

AMP meets the requirements of modern business machine and computer manufacturers for reliable, miniature wire terminations which can be installed at high speed. As the complexity of circuits and number of terminations increases, so must the dependability, efficiency and ease of application increase. AMP is constantly working to develop better and better solderless wiring to meet these requirements.

©1955 A-MP A-MP Trade-Mark Reg. U.S. Pat. Off.

*Have your name put on the AMP mailing list to receive valuable information about these developments.*

Examples of the advanced thinking that is part of all AMP solderless wiring devices:

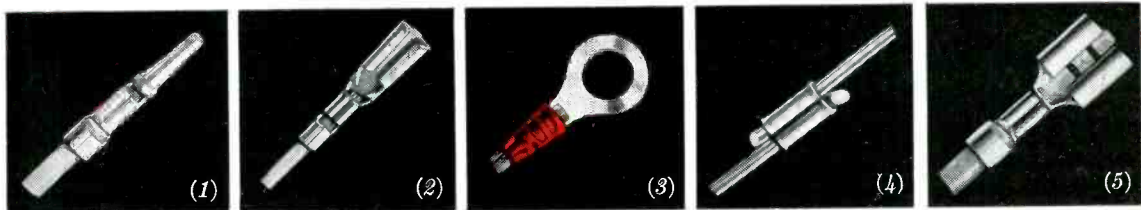

AMP TAPER PINS (1) and TAPER TAB RECEPTACLES (2) designed to save space and weight in electronic circuitry. AMP Pre-Insulated Diamond Grip Terminals (3) eliminate tape and spaghetti and are used extensively by every major aircraft producer. AMPLIVAR Splices (4) speed production for mass produced motor windings, transformers, etc., using enamel, poly-vinyl acetal or similarly coated wire. AMP FASTON Terminals (5) for all kinds of electrical appliances have revolutionized harness sub-assembly methods.

**AIRCRAFT-MARINE PRODUCTS INC.**  
 2100 Paxton Street, Harrisburg, Pennsylvania  
 IN CANADA: Aircraft-Marine Products of Canada, Ltd. 1764 Avenue Road, Toronto 12, Ontario, Canada



Now...TV pictures magnetically recorded on tape!

# Here's why magnetic tape is recommended by Ampex

Tests by Ampex Corporation show tape made with Du Pont "Mylar" gives best all-around performance on new "Videotape" recorder



"In developing our 'Videotape' recorder, we made extensive tests on various types of magnetic tape," reports the Ampex Corporation. "We had to be sure the performance of the tape was commensurate with the quality and durability built into our equipment. We found that tape made with 'Mylar' met all our requirements—that's why we recommend it to people who will be using our 'Videotape' recorder."

THE first practical method for recording TV sound and pictures on magnetic tape has been announced by the Ampex Corporation, Redwood City, California.

The Ampex "Videotape" recorder uses tape made with Du Pont "Mylar"\* for these important reasons: It's tape that can withstand unusual recording rigors without the risk of cracking or breaking—it can be stored indefinitely and played many times without any harm to either picture or sound quality.

Tape made with "Mylar" is strong, but thin enough to reproduce a whole hour's TV program on one 14-inch reel. It's virtually unbreakable—

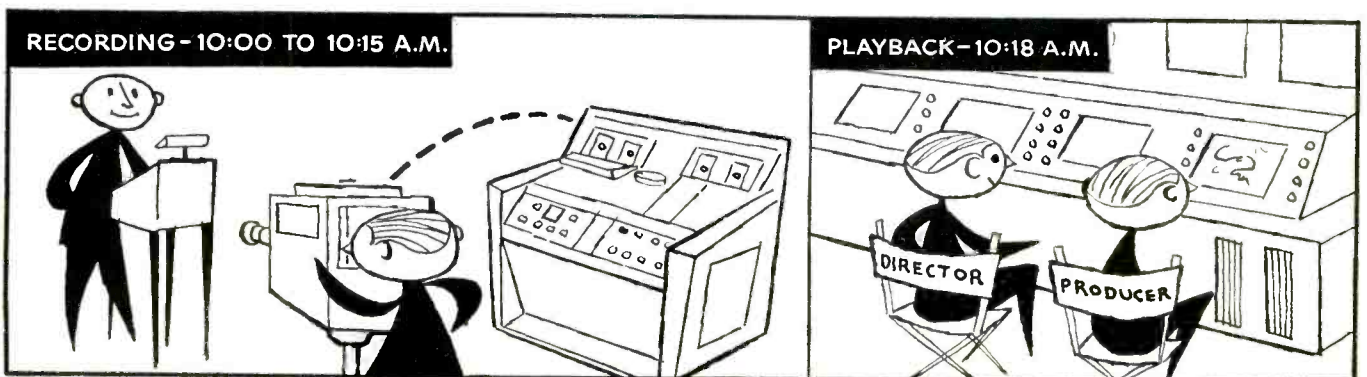

Here's how the new "Videotape" recorder works: As TV camera captures the action, it is recorded on magnetic tape along with the sound. The tape can then be played back *immediately*. This enables the producer and director to check the performance immediately without tying up costly talent and studio time.

# made with Du Pont "Mylar"<sup>®</sup> for "Videotape" recording

unaffected by changes in temperature and humidity. In short, the high tensile strength and dimensional stability of "Mylar" offer unlimited tape life under *all* conditions.

Here is another dramatic example of how Du Pont "Mylar" is helping industry improve established products and create new ones. Whether you make guided missiles or ladies' handbags, there may be a way this versatile new film can add value to your product. For more information on properties, applications and types of "Mylar" available, send in the coupon below.

**"MYLAR"** is Du Pont's registered trademark for its brand of polyester film. Du Pont manufactures the base material, "Mylar"—not finished recording tape. In Canada, "Mylar" is sold by Du Pont Company of Canada Limited, P. O. Box 660, Montreal, Quebec.



REG. U. S. PAT. OFF.

BETTER THINGS FOR BETTER LIVING... THROUGH CHEMISTRY

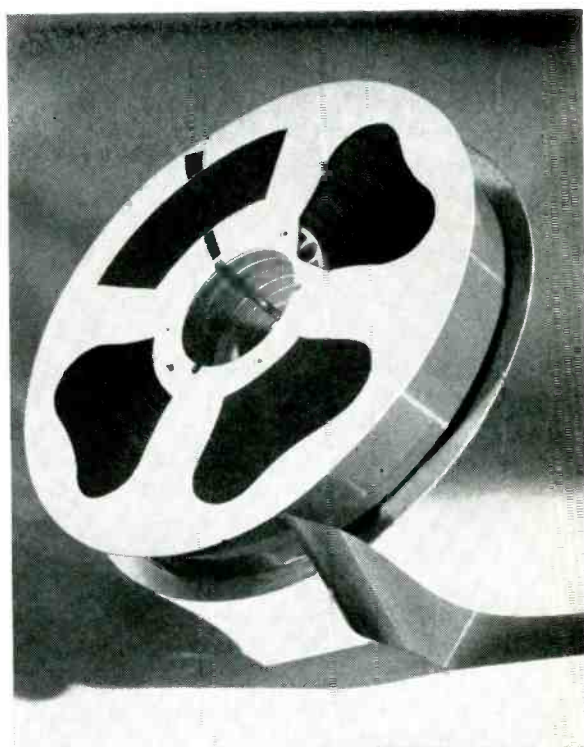
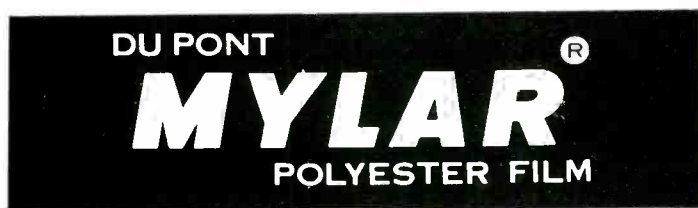

Reel of magnetic tape made with Du Pont "Mylar" is used in Ampex "Videotape" recorder. Because "Mylar" is extra-strong, even in thin gauges, a full hour's TV program can be recorded on a single 14-inch reel. Tapes assure faithful reproduction, even after repeated usage—can be stored indefinitely without becoming brittle or dry.

E. I. du Pont de Nemours & Co. (Inc.), Film Dept.  
Room E-10, Nemours Bldg., Wilmington 98, Del.

- Please send your booklet on properties, applications and types of "Mylar" polyester film available (MB-4).
- Please send your booklet outlining advantages of magnetic recording tape made with "Mylar" (MB-3).

Application \_\_\_\_\_

Name \_\_\_\_\_

Firm \_\_\_\_\_

Address \_\_\_\_\_

City \_\_\_\_\_ State \_\_\_\_\_

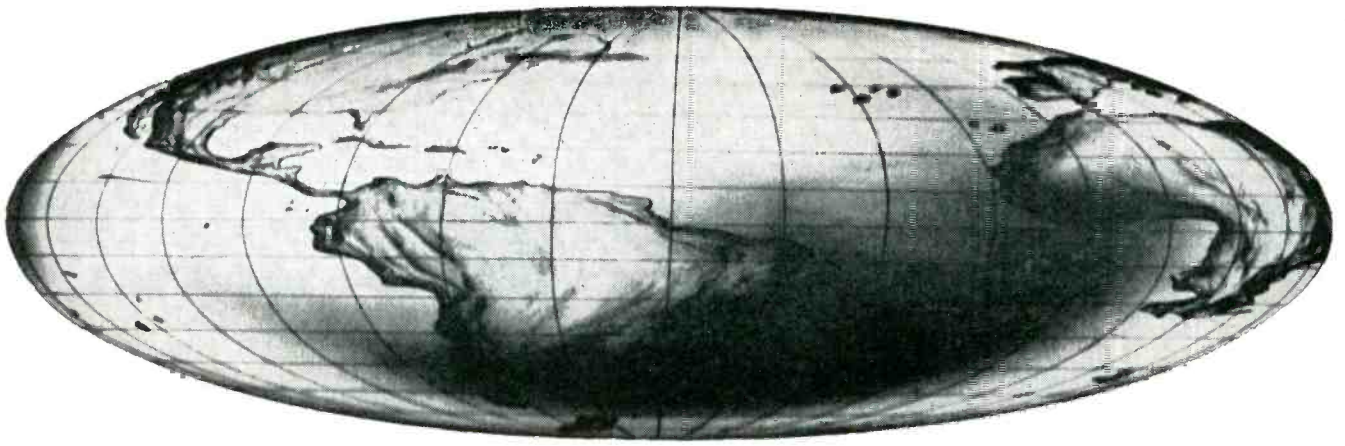

**in a thousand different environments . . .**

*Same*  
**RELIABLE  
 PERFORMANCE**

WITH *Constantin*  
 GLASS-TO-METAL SEALS

Constantin's pre-testing assures quality glass-to-metal seals that stand up under climatic extremes . . . and any one of the thousands of different Constantin seals will improve your present project, no matter what your particular requirement may be.

Constantin has long been noted in the electrical and electronic industries for its rigid inspection of all parts, from start to finish. They have pioneered in unique and difficult designs in such diversified items as multi-headers, all-in-one assemblies, transistor mounts, single terminals, end seals, crystal mounts, and other superior fabrications.

Constantin's experienced staff of design engineers are ready to help you with any glass-to-metal sealing problem. Write today for complete information.

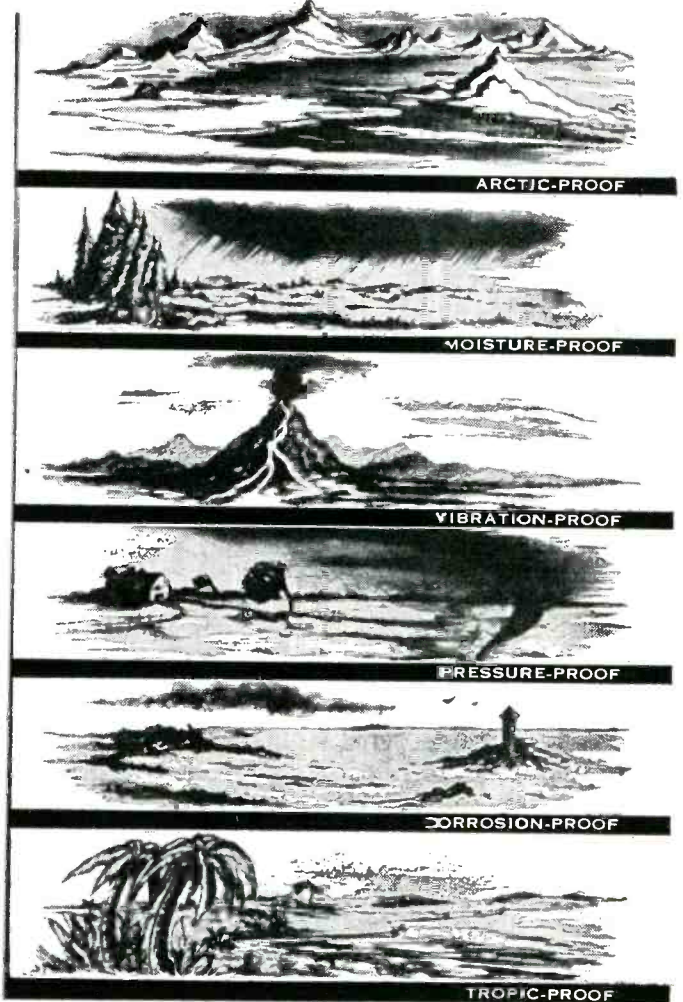

*L. L. Constantin & Co.* **MANUFACTURING ENGINEERS**  
 Route 46, Lodi, N. J. • 187 Sargeant Ave., Clifton, N. J.



TRANSISTOR MOUNTS • SINGLE TERMINALS • COMPRESSION HEADERS • END SEALS • CRYSTAL BASES • CONNECTORS • MINIATURIZATION



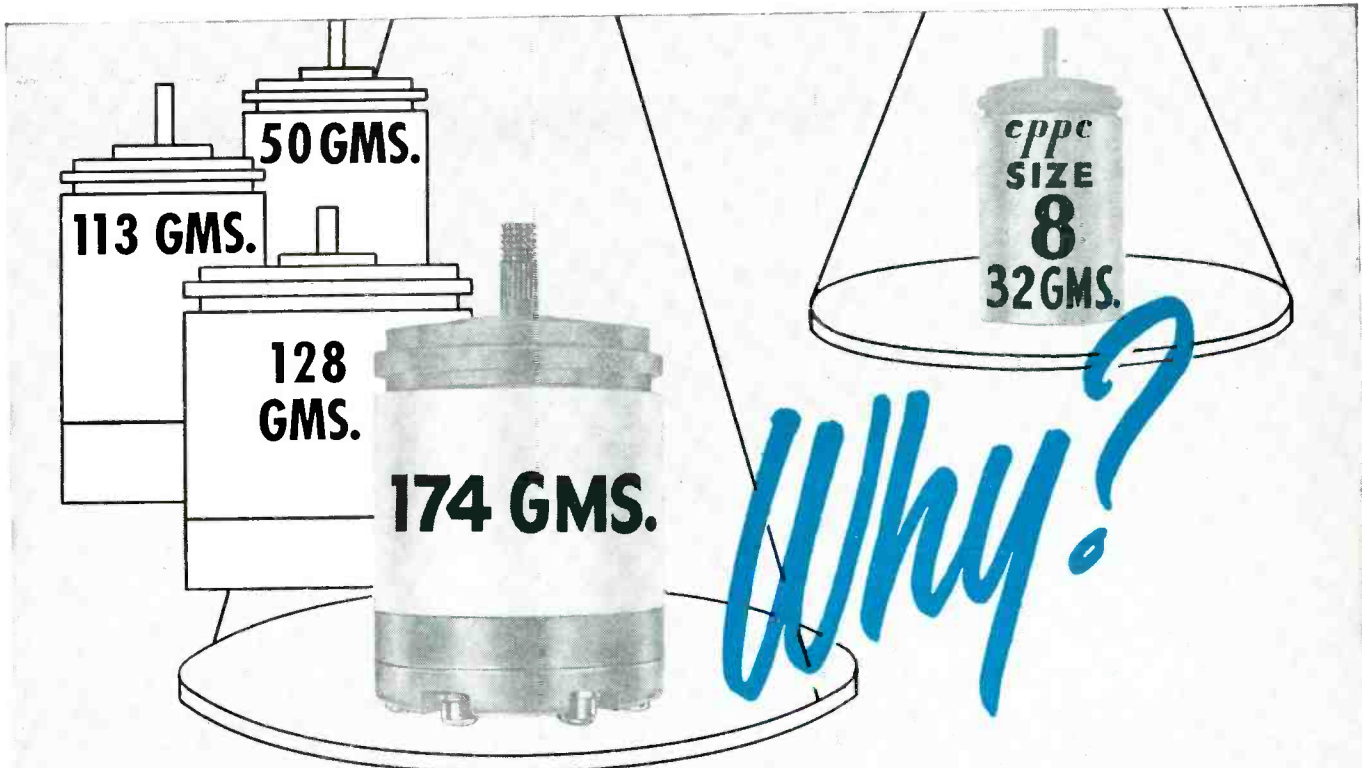

## WHY USE 1945 SYNCHROS IN 1956 DESIGNS?



STANDARD UNITS		ROTOR					STATOR					IMPEDANCE										
SYNCHRO FUNCTION	CPCC TYPE	Input V	Input A	Input W	Ohms (DC)	Output Rotor (MV/deg.)	Sensitivity (MV/deg.)	Output Volts (MV/deg.)	Sensitivity (MV/deg.)	Input Volts	Input Amps	Input Watts	Ohms (DC)	Zra	Zsa	Zrss	Phase R-S	Shift S-R	Nulls (MV)	Possible Error	Spd.	Length in inches
Torque Transmitter	CGC-8-A-7	26.0	100	.5	37	—	—	11.8	200	—	—	—	12	54+j260	12+j45	76.4+j19.6	8°	—	30	7'	14'	1.240
Control Transformer	CTC-8-A-1	26.0	.050	.25	143	24	410	11.8	200	11.8	.090	.23	25	220+j740	28+j110	246+j60	—	8.5°	30	7'	14'	1.240
Control Transformer	CTC-8-A-4	—	—	—	381	24	410	—	—	11.8	.037	.09	60	508+j1680	67+j270	640+j190	—	9.2°	30	7'	14'	1.240
Control Differential	CDC-8-A-1	—	—	—	36	11.8	200	—	—	11.8	.085	.21	25	38+j122	27+j120	48.6+j13.8	—	9°	30	7'	14'	1.240
Electrical Resolver	CSC-8-A-1	26.0	.039	.43	230	23.2	400	10.6	180	11.8	.084	.27	27	280+j600	38+j136	70+j136	20°	11°	30	7'	14'	1.240
Torque Receiver	CRC-8-A-1	26.0	.100	.50	37	—	—	11.8	200	—	—	—	12	54+j260	12+j45	85.1+j20.4	8°	—	30	30'	30'	1.240
Vector Resolver	CVC-8-A-1	1.26	.057	.34	78	—	—	—	—	11.8	.294	27	—	103+j444	28.8+j27.9	—	10.2°	—	1MV/V	—	1.240	



In equipment which must be flown, why load on extra weight?  
 Clifton's new Size 8 Synchros can take the place of larger units at very significant saving in bulk and weight.  
 These new Size 8's are now in use in some of the latest and lightest avionics equipment.  
 Samples are available from stock, quantities from the production line.

**CLIFTON PRECISION PRODUCTS CO. INC.**  
 CLIFTON HEIGHTS PENNSYLVANIA

# TEACHING A GIANT TO TAKE SHORT STEPS

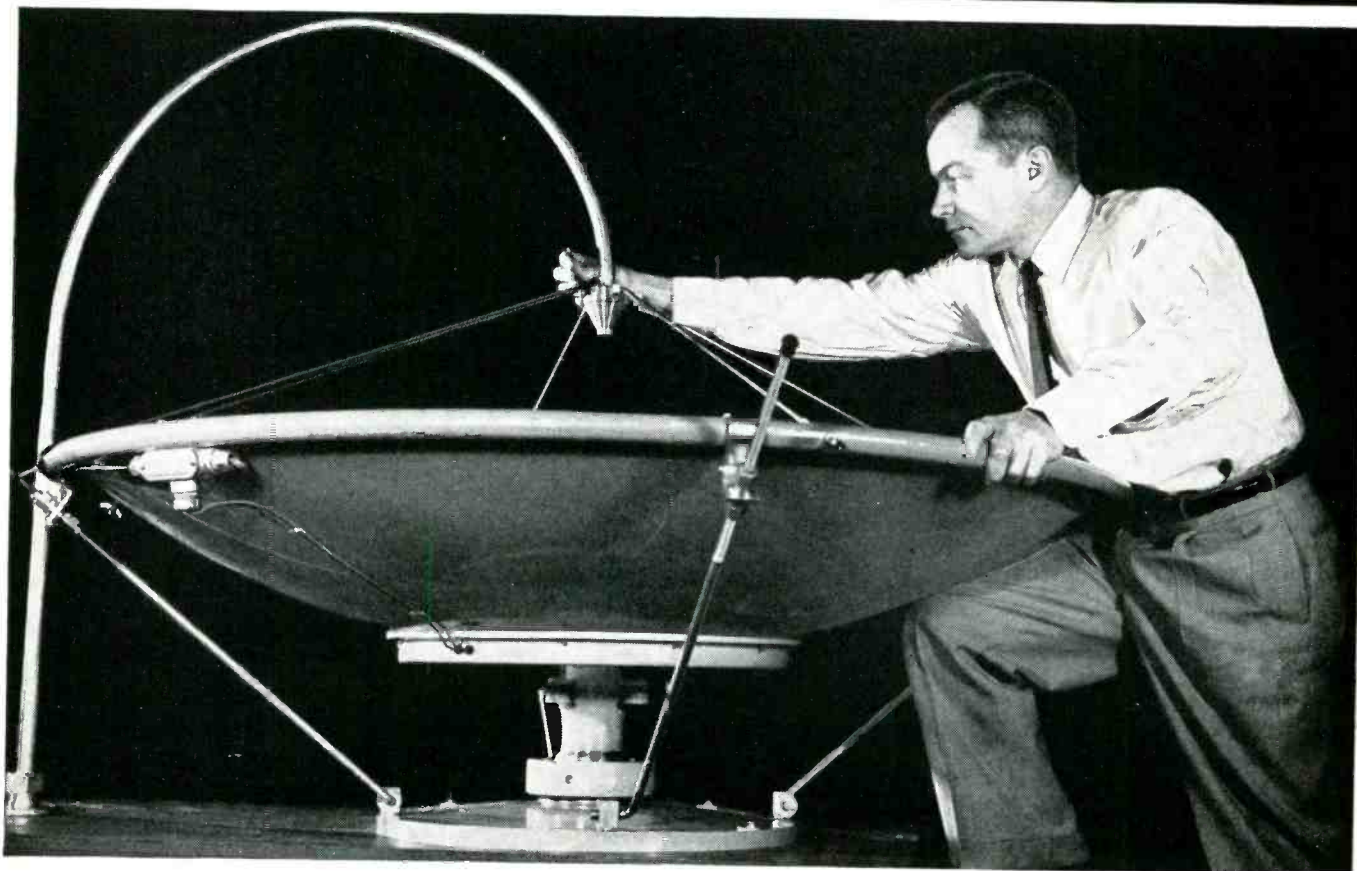

Bell Laboratories' Dr. J. W. Fitzwilliam adjusts a waveguide feed to a parabolic dish reflector. Dr. Fitzwilliam, who has a Ph.D. in physics from Massachusetts Institute

of Technology, leads the practical development of Bell's new 11,000-mc. system. Components had to be developed to operate in a frequency band not previously utilized.

The giant microwave highway that carries your TV programs along with telephone conversations from coast to coast has a versatile new partner — an entirely new microwave system which was created, and is now being developed, at Bell Laboratories. The new system operates at 11,000 megacycles — a much higher frequency than ever before used in telephone service.

Bell's present microwave systems — operating at 4000 megacycles — were designed for heavy traffic and long distances. The new system is designed especially for lighter traffic and shorter distances—up to 200 miles. Its traffic

capacity is extremely flexible. Depending on traffic needs, the system can provide only one one-way or as many as three two-way broadband channels. Each two-way channel can carry 200 telephone conversations simultaneously or one television program in color or black and white in each direction along a route. The new microwave system, which is already being operated experimentally, will be valuable in providing additional telephone service and television programs for cities in remote areas.

This is another example of how research and development work at Bell

Telephone Laboratories help the Bell Telephone System to serve you better.



Mr. L. C. Tillotson, who originated the new system, adjusts the klystron-isolator combination which made the system feasible. Mr. Tillotson, an M.S. from the University of Missouri, is in charge of research in microwave applications.

BELL TELEPHONE LABORATORIES

WORLD CENTER OF COMMUNICATIONS RESEARCH AND DEVELOPMENT



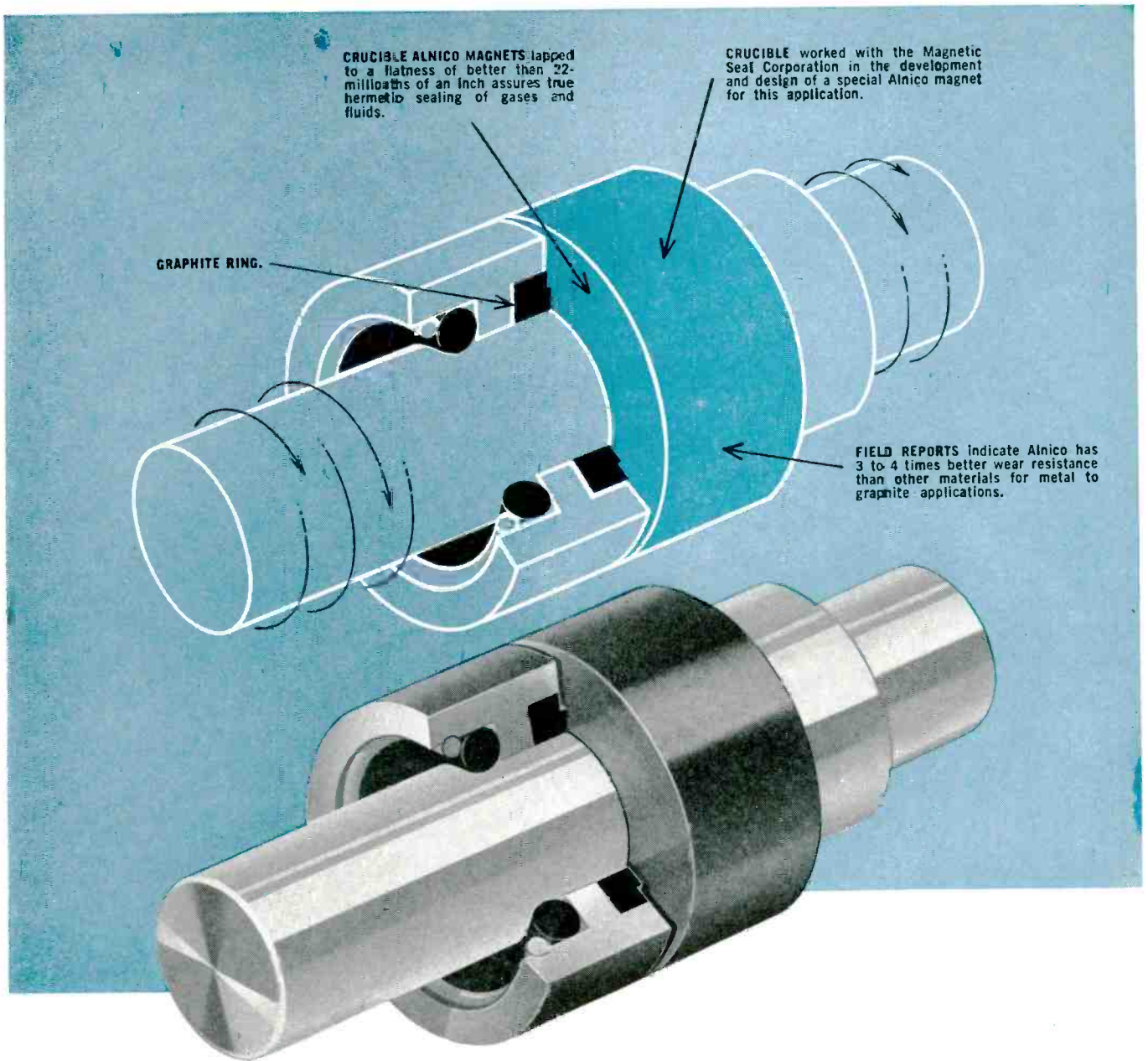

*in magnetic seals, too*

## **CRUCIBLE PERMANENT MAGNETS**

*mean maximum energy—minimum size*

The consistently higher energy product of Crucible Alnico magnets allows smaller parts—greater compactness in special applications like this magnetic shaft seal. What's more, the superior corrosion and wear resistance of Crucible Alnico insures far greater service life.

You can regularly get Crucible permanent

Alnico magnets sand cast, shell molded, or investment cast to exact size, shape or tolerance requirements . . . and in any size from a mere fraction of an ounce to hundreds of pounds. *Crucible Steel Company of America, The Oliver Building, Mellon Square, Pittsburgh 22, Pa.*

**CRUCIBLE**

first name in special purpose steels

**Crucible Steel Company of America**

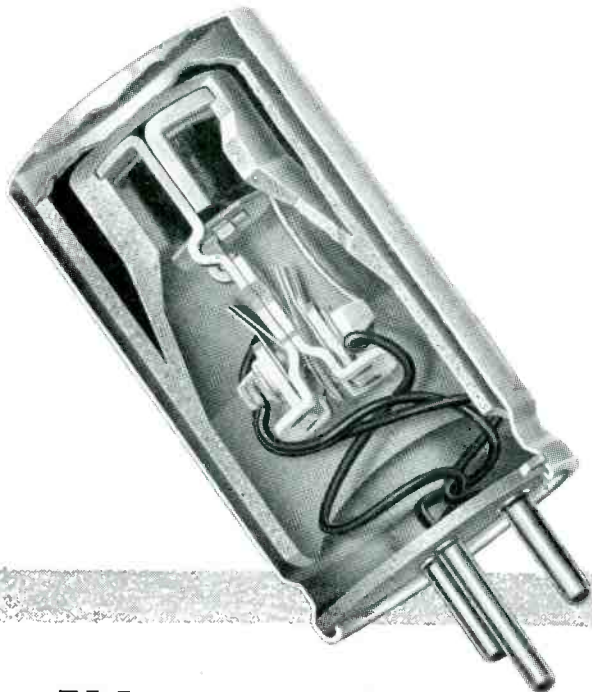

*Completely new design concept eliminates usual button contact, provides larger contacting area. New units have far longer life, lowest noise level yet . . . but cost no more.*

## *Vibrator life increased 50 to 100% . . . in newest Mallory design*

**S**TANDARDS of vibrator performance never before possible are being set by the latest development in Mallory vibrator engineering. Through the use of new design and materials, contact is made directly between vibrating reed arm and side arm—eliminating conventional contact buttons—providing far greater contacting area and longer life.

And in addition, a further refinement in the mounting of the vibrator establishes a new high standard of quieter operation.

The results of these new design concepts are important to everyone who designs, makes or uses vibrator-powered equipment.

**Life is increased 50 to 100% . . .** due to greater contacting area and far lower rate of wear.

**Sticking of contacts is eliminated.**

Serving Industry with These Products:

**Electromechanical**—Resistors • Switches • Television Tuners • Vibrators  
**Electrochemical**—Capacitors • Rectifiers • Mercury Batteries  
**Metallurgical**—Contacts • Special Metals and Ceramics • Welding Materials

Parts distributors in all major cities stock Mallory standard components for your convenience.

**Complete uniformity** of characteristics is made possible by this simplified design, which permits automatic production and adjustment techniques.

**Extra-quiet operation.** Mechanical hum is held to a new low level, due to the lighter mass of the mechanism, and to noise-squelching Mallory refinements.

**Smaller size** for equivalent load rating.

The new Mallory 1600 series vibrator is now available for auto radios, headlight dimmers, garage door openers and many other applications. In addition, the new leaf spring contacting concept is available in another new Mallory vibrator—the 1700 series for two-way communications equipment and other heavy duty applications.

*Expect more . . . Get more from*



# CROSS TALK

► **MATERIALS . . .** No component can be better than the materials of which it is made, and no electronic assembly can be better than its components.

The need for better and better materials has never been greater—there may be more new systems and circuits awaiting the birth of new materials than vice versa—so we recommend a particularly close reading of the special report beginning on page 185 of this issue and entitled *Materials for Electronics*.

► **PROTECTION . . .** Patent applications seem to be lagging behind the rate at which new developments are emerging from corporate research laboratories.

Reasons may include consent decrees that have made some existing patents available to the public without royalties and unwillingness of some higher courts to grant judgments against alleged patent infringers. A few firms now believe that strict commercial secrecy offers the best protection of their proprietary interests.

We disagree. The engineering mind is not like a well from which only a finite number of ideas can be drawn. Rather it is like a river that accepts the contributions of tributary streams that help it flow onward.

The sure road to technical progress and commercial success

lies in the continuing multiplication of ideas rather than in the jealous protection of past developments.

► **APPLAUSE . . .** A palm for the television receiver manufacturer who has just brought out a set incorporating at least half a dozen features deliberately designed to facilitate servicing.

It takes nothing away from this company to say that throughout the business servicing difficulties encountered by distributors and dealers alike are now reflecting so seriously back to manufacturers that they have to do something about it to protect themselves if nobody else.

► **BRIGHTNESS . . .** Portable tv sets are used outdoors more than other types. And outdoors in daylight the light level is high.

Older sets using small picture tubes frequently provide nice bright pictures, so it comes as something of a shock to purchasers of some new portables that these appear to be deficient in brightness. Part of this is imaginary and due to the different conditions of use, but some of it is due to a skimping of power supply to hold the price down or keep the set compact or both.

Even worse infringement upon the minimum requirements of design is the skimping or utter omission of reflection-reducing devices.

## LOOKING AHEAD . . .

Improved wide-band circuit design and electron-tube mixers of radically new design may once again make untuned-radio-frequency-amplifier receivers practical reality

*Increasing flow of technical information from Russia and satellite countries could indicate possible thaw in cold war*

Specially designed glow tubes show increasing promise as measurement devices. Automobile industry is especially interested

*Electronic consumer products such as refrigerators, clocks and stoves may one day rival radio-tv sales in volume. On the immediate horizon is an electronic typewriter*

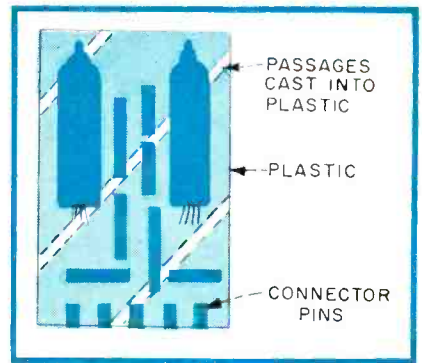
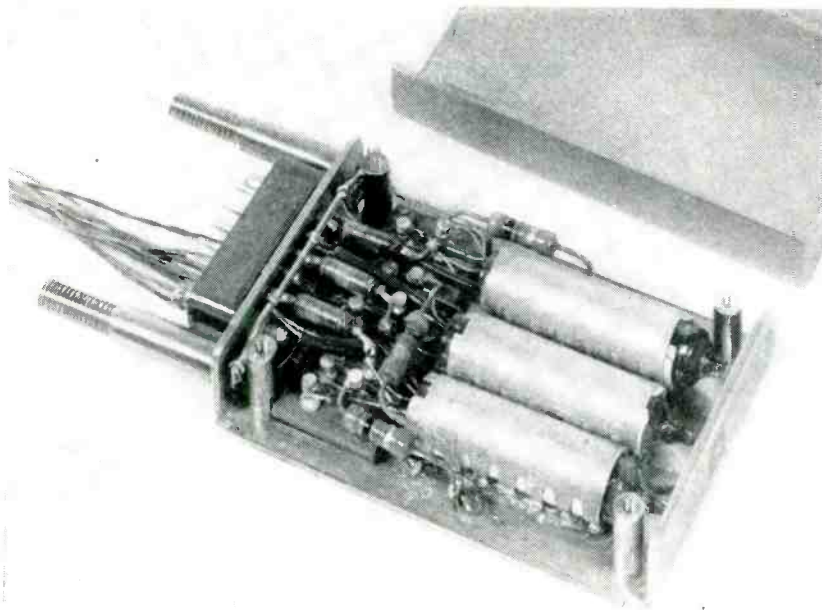

FIG. 1—Simple plastic encapsulation with tubes and resistors near the surface for maximum cooling

Heat from tubes passes to chassis and then through heavy studs to cold plate

# Taking The Heat Off

**M**OST electronic equipment must incorporate some means for heat rejection. This will be necessary until the efficiency of electronic equipment is improved. As long as power is dissipated it will be rejected in the form of heat. The purpose of any electronic cooling system is to provide a low-resistance thermal path to a low-temperature heat sink that will absorb this waste heat. Such a system will reduce the temperature rise of electronic parts and equipment.

There are two basic philosophies of cooling electronic equipment. The first is the brute force approach, wherein high temperature electronic parts are used without special cooling means. The temperatures soar and heat rejection is achieved through operation of the parts at high temperatures.

When used at low ambient temperatures to alleviate hot spots, this approach is inherently inefficient and expensive. The utilization of high temperature parts is not recommended for the deficiencies of an inferior cooling system.

The second concept is controlled heat removal whereby the heat is directed along desired paths. This approach requires the application

of careful design to the entire thermal system and the establishment of low temperature gradients to protect temperature-sensitive parts and circuits.

Of prime importance is the necessity for directing the heat from the sources along specified paths to a low temperature sink so the heat is

not indiscriminately scattered and transferred into adjacent electronic parts.

## Rating Parts

In general, component parts are individually rated for certain performance at specified ambient temperatures. Ambient temperature

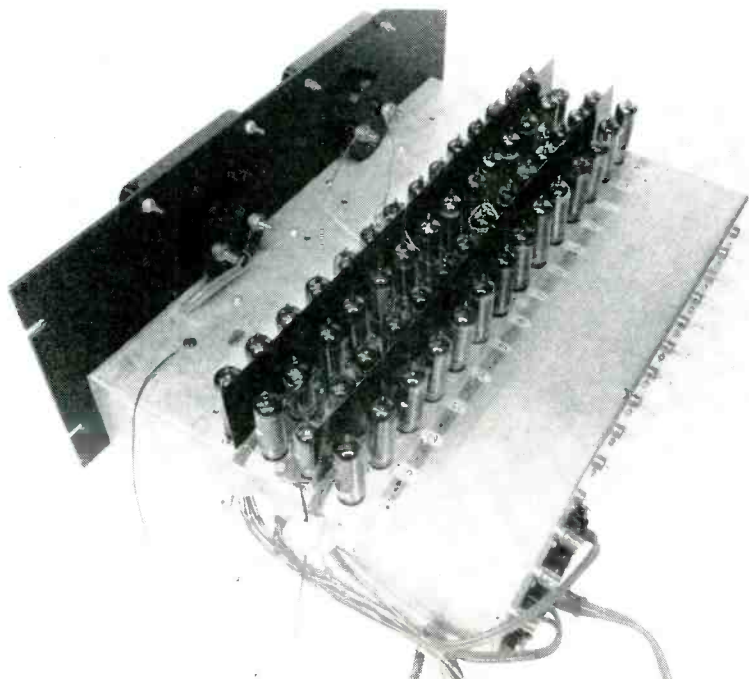

Multitube unit upon which tests were performed. Thermocouple wires show below

**SUMMARY**—Decreased size and increasing complexity of electronic equipment promises ever greater heat concentration. Brute-force methods of reliable operation dependent upon high-temperature components are now giving way to establishment of low-temperature-gradient paths, maintained by adequate heat transfer and effective heat sinks

By **JAMES P. WELSH**

*Industrial Division  
Cornell Aeronautical Lab., Inc.  
Buffalo, N. Y.*

# Miniature Equipment

rating alone is not satisfactory, because almost every organization has a slightly different definition and interpretation.

Not only should individual part rating be considered, but the group characteristics of parts must also be assayed collectively. The thermal interaction owing to the mutual heating of adjacent parts can cause greatly increased temperatures over those obtained with solitary parts.

Ambient temperature is only the temperature of the medium surrounding an object. This does not always define the true thermal situation as it may exist around an electronic part. With densely packaged equipment, the local air temperature is not directly related to the heat radiation or conduction effects from nearby heat sources.

These effects are frequently significant and can lead to the overheating of parts even though the ambient temperature rating is satisfactory only for conventional equipment, with widely separated heat sources operated at relatively low temperatures.

The limiting temperatures involved in part rating are those that the constituents can withstand before they oxidize, melt, decompose or change value. Internal temperatures are usually difficult to measure. Therefore, the best practical index of the thermal condition of the interior of an electronic part is its surface temperature or the change in value of a readily measurable electrical parameter. Neither of these characteristics is neces-

sarily related to the temperature of the surrounding air.

## Equipment Rating

Most electronic equipment is rated in terms of ambient temperature. Specifications generally define ambient ratings. A more realistic approach would incorporate thermal environment ratings that can provide the equipment designer and user with definite thermal parameters.

The thermal environment can be defined as the condition of fluid type, temperature, pressure and velocity; it involves surface temperatures, configurations and emissivities; it includes all conductive thermal paths surrounding an electronic device.

A figure of merit for cooling is

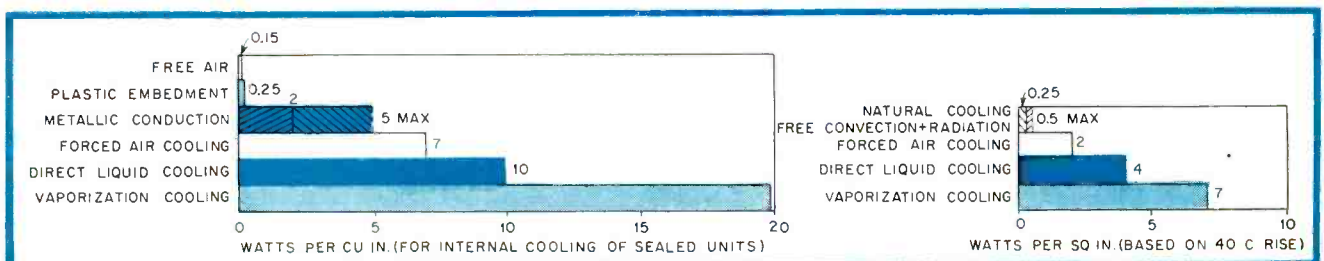

FIG. 2—Comparison of cooling methods

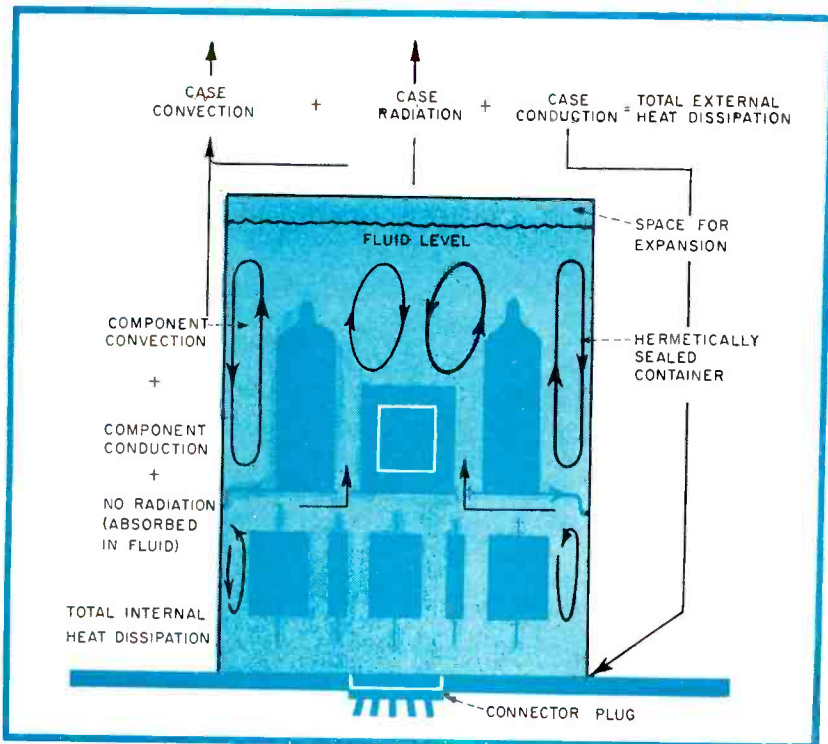

FIG. 3—Simple direct liquid cooled subassembly

the heat concentration in watts per cu in. In those instances wherein the external surface area of the device limits the thermal resistance, the unit heat dissipation in watts per sq in. is also employed as a secondary figure of merit.

While the thermal design of electronic equipment has not been reduced to an exact mathematical science, the order of magnitude of any specific cooling design can be determined. Since this places the design in a finite known range, the limits of the design and experimentation can be established.

Selection of the cooling method should be preceded by the breadboard development of the electronic circuit. If the electronic performance is influenced by the cooling method, the circuit of the prototype model should be modified after the initial breadboard tests.

Cooling methods discussed below are predicated upon the heat concentrations and signal frequencies involved in shipboard and ground based equipments. Other factors such as the complexity of the equipment, space, power, thermal environment, available sinks and cost must also be considered by the designer.

The optimum method of heat removal within a subassembly and a

unit may differ from that used to transfer heat to the ultimate sink.

#### Various Methods

The method of heat removal from within a unit must provide a low temperature gradient between the heat producing parts and the cooled surface or the local sink. The cool-

ing method must be simple, light weight, reliable, easily maintained and economical. It should occupy a minimum of volume, preferably utilizing the voids between densely packaged parts.

Table I presents the relative magnitudes of various heat transfer methods. The values listed are representative and may vary with conditions. Comparison is made on the basis of conductance, which is the heat transfer rate per unit area per degree temperature difference.

Natural cooling means are recommended for use within most miniaturized electronic subassemblies. They are frequently the only possible means of heat removal. Hermetic sealing and the dense packaging of parts can prevent the use of other techniques.

Metallic conduction should be considered initially as the primary cooling means. Radiation cooling is not recommended as a primary means, since high temperature differences are required for appreciable heat transfer. The control of the cooling path is lost since the heat may be radiated into nearby units.

Convection cooling requires large areas, which are seldom available within subassemblies. Convection currents will frequently transfer the heat into other locations that

Table I—Representative Magnitude of Heat Transfer Processes

	Btu hr × sq ft × deg F	Watts sq in. × deg C
Conduction through copper 0.1 in. thick	26,160	95.20
Conduction through Pyrex glass 0.1 in. thick	87.36	0.322
Conduction through cork board 0.1 in. thick	3.0	0.011
Free convection from 6 in. high vertical plate at 120 C, air at 80 C	0.96	0.00348
Forced convection, air over 6 in. plate at 8 ft/sec, mean temp air and plate of 100 C	2.84	0.0104
Forced convection 40 C water flowing at 5 ft/sec in 2 in. diam pipe	1,420	5.19
Water boiling on a flat plate at atmospheric pressure	2,000	7.30
Steam condensing on a flat plate at atmospheric pressure	1,000	3.65
Radiation between two black bodies at 100 C and 50 C	1.72	0.0063
Radiation between two black bodies at 500 C and 50 C	9.81	0.0287



will then require additional cooling.

Plastic embedment may be used only for heat concentrations up to the order of 0.25 watt per cu in. at ambient temperatures in the order of 85 C maximum. Figure 1 illustrates such a configuration. Metallic conduction can be used for heat concentrations as great as 2 watts per cu in. as shown in Fig. 2. The maximum unit heat dissipation for free-air cooled surfaces is usually 0.25 watt per sq in. In a few high temperature devices, unit heat dissipations as high as 0.5 watt per sq in. have been achieved.

A conduction-cooled subassembly similar to that illustrated in a photograph has a power dissipation of 10 watts, a volume of 4.7 cu in. and a weight of 0.49 lb. It has a unit heat dissipation of 0.5 watt per sq in., a heat concentration of 2.1 watts per cu in. and is rated for operation at 150 C sink connector temperature at the cooling terminations.

This subassembly is not capable of dissipating its internally generated heat from its external surfaces. If such dissipation were necessary, the subassembly would need to be considerably larger, which would defeat the aim of miniaturization. The subassembly is designed so its rejected heat can be removed from the cooling studs into a controlled path.

The internal temperatures at 150 C sink connector temperature are approximately 175 C at the hot spots of the tubes and 160 C on the other parts. Thus, the maximum internal temperature rise is 25 C.

### Sealed Units

Hermetic sealing is essential for certain equipments that must operate under rigorous climatic and environmental conditions. Protection using one large seal is advantageous but it prevents easy access for servicing by requiring the entire subassembly to be opened with consequent loss of any inert gas or liquid and the possible entrance of moisture.

Sealed subassemblies, however, can be easily replaced, especially if they are plug-in types. Certain electronic circuits such as r-f, i-f and video amplifiers cannot tolerate the increased capacitance and losses as-

### EIGHT RULES OF COOLING

1. Temperature difference controls the rate of heat transfer in any given configuration.
2. Under steady-state conditions, thermal equilibrium or a heat balance is maintained and all heat will be rejected with resultant high temperature gradients.
3. Measurement of temperature is necessary to define thermal parameters.
4. Heat flow is analogous to Ohm's Law. With constant power dissipation temperature rise or gradient is a function of the resistance of the thermal path.
5. Only the earth, its atmosphere or a large body of water are ultimate sinks; a chassis has finite heat capacity, but it can be used as an intermediate or local heat sink.
6. Satisfactory thermal design starts simultaneously with electrical and mechanical design of electronic equipment.
7. Electronic performance must not be affected by thermal design; compromise is more often the rule rather than the exception.
8. Owing to the complex nature of heat transfer, high accuracy can seldom be achieved, but this is no hindrance to accomplishment of practical cooling systems.

sociated with plastic embedment. In such instances an inert gas is advisable. Gases with high thermal conductivities such as helium or hydrogen can be used to increase heat transfer by gaseous conduction. Helium penetrates glass.

Forced air provides an excellent cooling method, which can be used if the spacing between parts within the unit is adequate for air flow. Considerable heat can be removed by this method as shown in Fig. 2.

Individual parts with heat dissipations as great as 2 watts per sq in. can be cooled at low Reynolds numbers. However, the power required to force air over objects and through ducts and heat exchangers may be considerable. The interchangeability of forced air cooled subassemblies will be limited to a few special equipments that are provided with adequate fans and ducting for each subassembly.

Larger equipments can be cooled efficiently with forced air. The 56-tube chassis shown in one of the photographs dissipates 950 watts.

Wire leads at lower center come from thermocouples that are used to monitor the anode 6AQ5 bulb temperatures.

### Liquid Cooling

Direct liquid cooling is particularly applicable to subassemblies having high heat concentrations or those that must operate in high temperature environments with small temperature gradients between parts and cooled surfaces. Unfortunately, direct liquid cooling can be used only in circuits that can tolerate the increased stray capacitance and electrical losses resulting from high dielectric constant and power factor of liquids used.

New equipments can be designed for several types of liquid cooling systems, any one of which may have cooling capacities greater than that of forced air systems, as shown in the chart. The cases of sealed subassemblies can be designed for direct immersion in the coolant (indirect liquid cooling) or the subassembly can be filled with a liquid

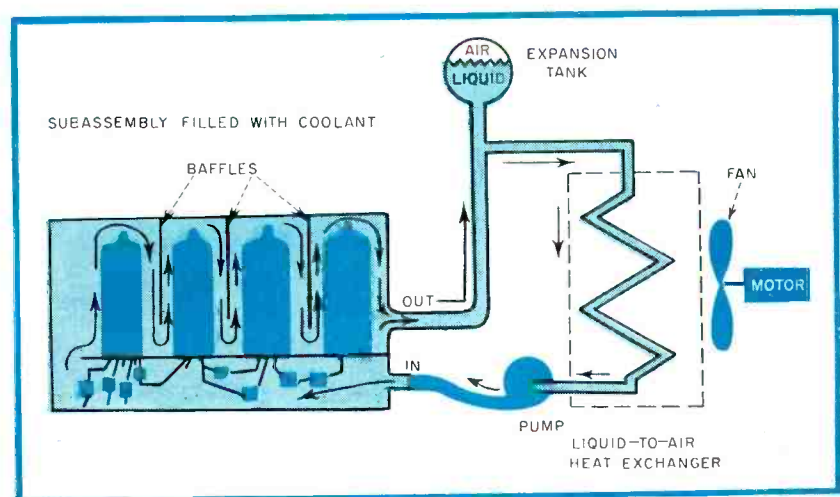

FIG. 4—Direct forced liquid cooling system

such as a silicone fluid (direct liquid cooling). The elements of such a system are shown in Fig. 3.

Heat removal may be increased by the addition of forced circulation of the coolant. However, this additional cooling is at the expense of more power to operate the pump and its accessory equipment. The weight of directly immersed equipment may be reduced by spraying the coolant over the heat producing parts and pumping the heat-bearing coolant from the bottom of the container through a heat exchanger and back to the spray nozzles. Such a cooling system (Fig. 4) represents a saving in the amount of coolant liquid required, but requires a higher pressure pump and more power to run the pump.

Direct liquid cooling is most applicable to power supplies, modulators, servo amplifiers and wide-band low-frequency amplifiers. The coolant must be chemically and electrically compatible with the electronic parts and the case. If liquid cooling is applied to equipments that operate over a wide range of environmental temperatures, a non-freezing coolant must be used.

#### Miniature Components

Liquid cooling frequently permits a greater degree of miniaturization because of the larger permissible heat concentrations. If a coolant with a high dielectric strength is used, voltage ratings can be increased. Containers must be able

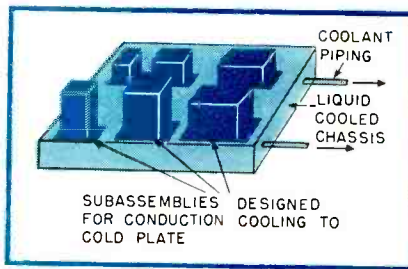

FIG. 5—Liquid cooled cold chassis

to expand at elevated temperatures.

Unless the coolant is chemically inert, electronic parts may decompose; also, maintenance is increased and a leak may disable the unit.

Repairing direct liquid cooled equipment is complicated by the need for draining the fluid before working on the unit. Indirect liquid cooling overcomes some of the above disadvantages but requires a pump and heat exchangers. See Fig. 5.

Vaporization cooling is the most effective heat removal method known. It has the advantages and disadvantages of the direct system together with greatly increased cooling power. Expendable systems are simple, but involve disposal of the vapor and replacement of the coolant. Nonexpendable or continuous systems are complex, expensive and necessitate the use of a heat exchanger to condense the vapor back into a fluid. A direct evaporative spray cooling system is shown in Fig. 6.

Vaporization cooling systems are particularly suited to installations with extremely high heat concen-

trations and those installations where no sink is available or the sink is remotely located.

#### Ultimate Sinks

Transfer of heat from the unit chassis to the sink depends upon the method of heat removal from within owing to the common connection between the two phases of heat rejection. The optimum method of heat transfer also depends upon the type of sink available, its location and its temperatures. Temperatures of local or intermediate sinks may increase with additional heat.

Natural heat transfer from miniaturized subassemblies to an intermediate sink is best accomplished by metallic conduction cooling. However, the intermediate sink cannot be located at any significant distance from the subassemblies. Structural parts may be used, if they have low thermal resistance.

Natural convection and radiation may be used at the sink if the local sink is air of a relatively low temperature. The maximum heat dissipated by the surfaces should seldom exceed 0.25 watt per sq in. and should be limited to approximately 0.50 watt per sq in. Even so, relatively high temperatures can easily be achieved. It is, therefore, recommended that this mode of cooling be used only with equipments of low heat concentration, provided that the rejected heat is not introduced into other nearby equipment.

Forced air is more applicable to this phase of cooling than natural methods particularly if the sink is nearby air. The air should be properly directed and distributed over the subassemblies. Unit heat dissipations of the order of 2 watts per sq in. can be obtained readily.

When electronic equipment is to be operated in high temperature environments at high heat concentrations or when the sink is located at a distance from the equipment, optimum cooling can be achieved by an indirect forced liquid cooling system. This cooling mode, using fresh water, is especially recommended for shipboard usage.

Indirect vaporization cooling will provide the maximum obtainable cooling. It is recommended for use only with devices having extremely high heat concentrations.

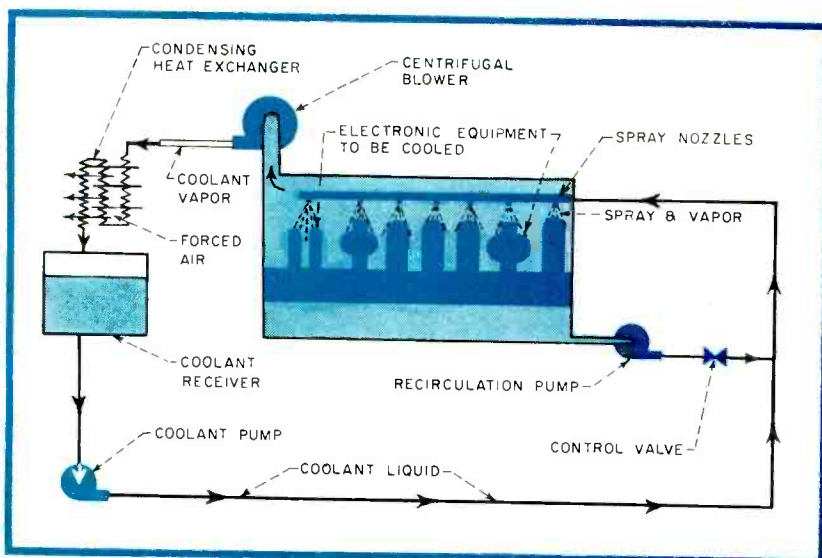

FIG. 6—Direct evaporative spray cooling system

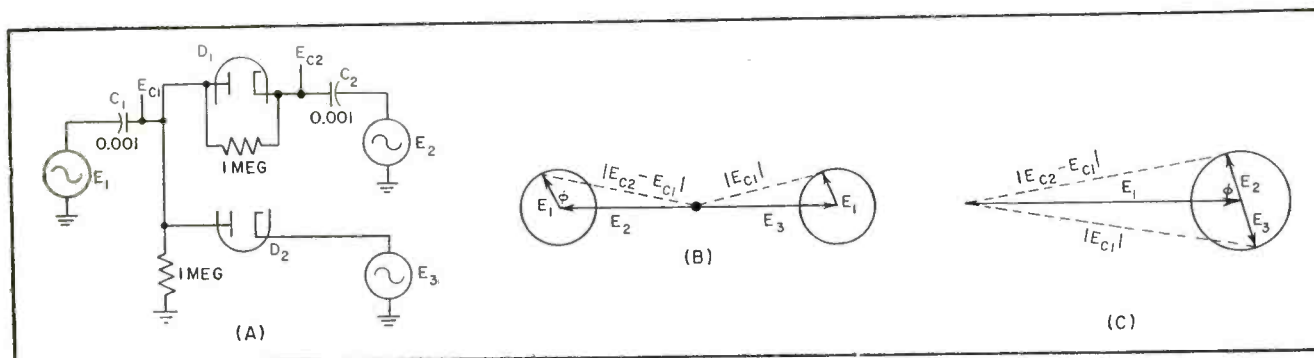

FIG. 1—Basic double-diode balanced phase detector (A) of prior art and vectors and voltages across  $C_1$  and  $C_2$  (B and C)

# Three-Phase Detector for Color-TV Receivers

**SUMMARY** — Replacing two double-diode detectors with one triple-diode balanced phase detector provides noise-immune operation for color receiver automatic-frequency-control, automatic-chroma-control and color-killer circuits. Action of automatic-chroma-control and color killer remains effective with signal levels as low as 20 microvolts

**B**ALANCED PHASE DETECTORS are used in color television receivers for comparing the phase of the incoming 3.58-mc color-burst signal with the phase of the locally generated 3.58-mc signal and correcting the latter (afc). A balanced phase detector is characterized by good noise immunity.

Color-killer and automatic chroma control (acc) circuits are also actuated from the color burst. These control signals are usually derived from nonsynchronous, unbalanced detectors and prevent good color killing and acc with incoming signals of less than 100  $\mu$ v.

This article describes a three-diode detector that replaces two double-diode detectors to provide noise-immune operation for all three receiver functions, afc, acc and color killer.

## Double-Diode Detector

The double-diode detector of the prior art is shown in Fig. 1A. Basically, this circuit consists of two peak detectors in series; the d-c output voltage is the sum of

By **A. A. GOLDBERG**

Project Engineer  
CBS Laboratories  
New York, N. Y.

the potentials. If the R-C time constants are sufficiently large, the output is insensitive to the values of R and C.

The exact equations for  $E_{C1}$  and  $E_{C2}$  are

$$E_{C1} = -[E_1^2 + E_3^2 - 2E_1E_3 \cos \phi]^{1/2} \quad (1)$$

$$E_{C2} = [E_1^2 + E_2^2 + 2E_1E_2 \cos \phi]^{1/2} + E_{C1} \quad (2)$$

where  $\phi$  is the phase difference be-

tween  $E_1$  and  $E_2$ . Inputs  $E_2$  and  $E_3$  are always 180 degrees apart. All a-c voltages are peak values.

If  $E_1$  is smaller than  $E_2$  and  $E_3$ , the vectors are as shown in Fig. 1B and the simplified approximate forms of Eq. 1 and 2 are

$$E_{C1} \approx -(E_3 - E_1 \cos \phi) \quad (3)$$

$$E_{C2} \approx E_2 + E_1 \cos \phi + E_{C1} \quad (4)$$

Replacing  $E_{C1}$  in Eq. 4 with Eq. 3

$$E_{C2} \approx E_2 - E_3 + 2E_1 \cos \phi \quad (5)$$

and, if  $E_2$  equals  $E_3$ , then

$$E_{C2} \approx 2E_1 \cos \phi \quad (6)$$

If  $E_1$  is larger than  $E_2$  and  $E_3$ , the vectors of Fig. 1C are representative. When  $E_2$  equals  $E_3$

$$E_{C2} \approx (E_2 + E_3) \cos \phi \quad (7)$$

When  $E_1$  is zero,  $E_{C2}$  is zero, assuming that  $E_2$  equals  $E_3$ . If a nonsynchronous signal such as noise is inserted at  $E_1$ ,  $E_{C2}$  still remains zero. A nonsynchronous signal can be represented by a vector rotating at a random rate and thus integrating to zero because of the detector time constant. Voltage  $E_{C2}$  remains zero only when  $E_2$  equals  $E_3$ , otherwise  $E_{C2}$  equals the differ-

Table I—Factors Affecting AFC

Parameter	Double Diode	Triple Diode
Damping Coefficient	0.475	0.268
Noise Bandwidth (cps)	219	157
A-C transmission ratio	0.052	0.0123
Filter shunt time constant (sec)	0.0033	0.0033
Static phase error (deg)		
for $\Delta f = 50$ cps	1.62	0.68
100 cps	3.24	1.36
150 cps	4.86	2.04
Pull-In range (cps)		
for $T = 0.1$ sec	375	260
$\infty$	570	660

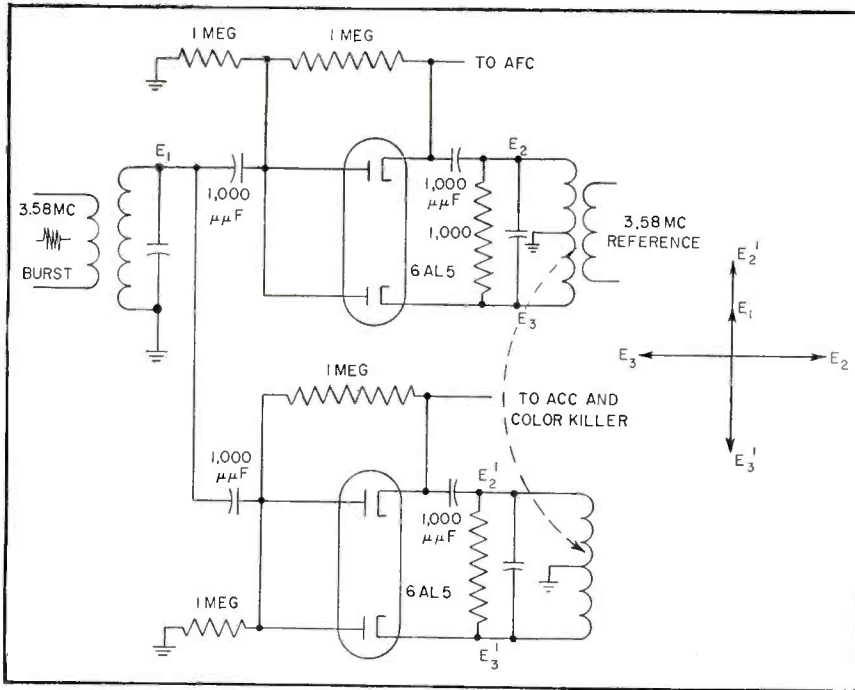

FIG. 2—Application of dual double-diode detectors for noise-immune operation

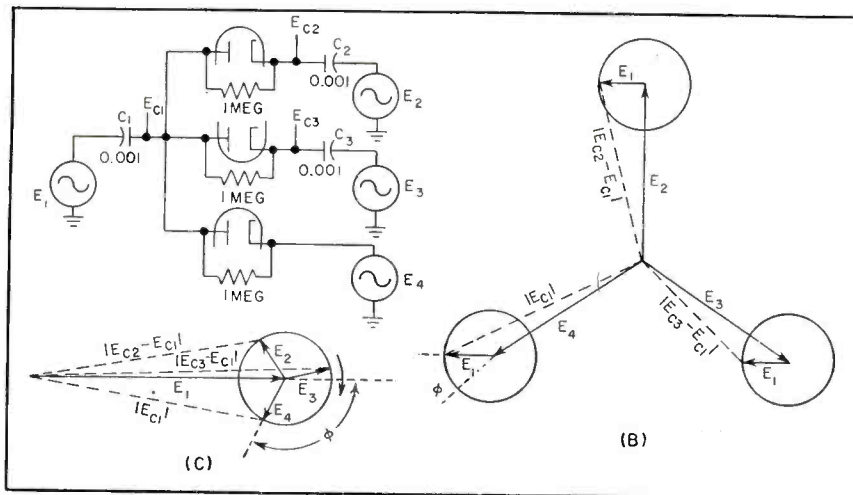

FIG. 3—Basic triple-diode detector (A) and voltage and phase relationships (B and C)

ence of the absolute values of  $E_2$  and  $E_3$ .

When  $E_1$  equals  $E_2$  and  $E_3$  and the exact Eq. 1 and 2 are plotted,  $E_{c1}$  and  $E_{c2} - E_{c1}$  become cycloidal in shape and the resultant  $E_{c2}$  approximates a triangular wave shape as  $\phi$  is varied.

### Dual Double-Diode Detector

Figure 2 shows how two detectors can be employed for noise-immune operation.<sup>1</sup> The incoming color burst is applied at  $E_1$  in parallel to the two detectors. The locally generated 3.58-mc reference voltage is coupled into the top detector bifilar transformer and phase-split into voltages  $E_2$  and  $E_3$ .

As shown in the vector diagram,  $E_2$  and  $E_3$  are in quadrature with  $E_1$  and the resultant afc output voltage is zero.

Any departure from the quadrature relationship causes the afc output to go symmetrically either negative or positive, depending upon the direction of phase error. The afc output controls the bias of the reactance tube which in turn corrects the phase of the local 3.58-mc oscillator.

A second resonant circuit is loosely coupled to the  $E_2$ ,  $E_3$  circuit and produces two additional voltages  $E_2'$  and  $E_3'$  which are in quadrature with  $E_2$  and  $E_3$ . This causes the lower detector to operate

in a synchronous mode and the acc, color-killer output is a negative d-c voltage. The acc voltage is usually applied through a pulse amplifier to the chroma amplifier and varies the chroma gain as an inverse function of burst amplitude. The color-killer voltage is used to shut off the chroma amplifier in the absence of a color burst (monochrome reception).

### Triple-Diode Detector

In the interest of reducing the required number of envelopes from two to one, the circuit of Fig. 3A was developed. Voltages  $E_2$ ,  $E_3$  and  $E_4$  are equal and 120 degrees apart in phase.

The exact equations for  $E_{c1}$ ,  $E_{c2}$  and  $E_{c3}$  are

$$E_{c1} = -[E_1^2 + E_4^2 - 2E_1E_4 \cos \phi]^{1/2} \quad (7)$$

$$E_{c2} = [E_1^2 + E_2^2 - 2E_1E_2 \cos(\phi + 120)]^{1/2} + E_{c1} \quad (8)$$

$$E_{c3} = [E_1^2 + E_3^2 - 2E_1E_3 \cos(\phi - 120)]^{1/2} + E_{c1} \quad (9)$$

If  $E_1$  is smaller than  $E_2$ ,  $E_3$  and  $E_4$ , the vectors are as shown in Fig. 3B and the simplified approximate forms of Eq. 7, 8 and 9 may be employed

$$E_{c1} \approx -(E_4 + E_1 \cos \phi) \quad (10)$$

$$E_{c2} \approx E_2 + E_1 \cos(\phi + 120) + E_{c1} \quad (11)$$

$$E_{c3} \approx E_3 + E_1 \cos(\phi - 120) + E_{c1} \quad (12)$$

Replacing  $E_{c1}$  in Eq. 11 with Eq. 10

$$E_{c2} \approx \sqrt{3} E_1 \cos(\phi + 150) + E_2 - E_4 \quad (13)$$

Replacing  $E_{c1}$  in Eq. 12 with Eq. 10

$$E_{c3} \approx \sqrt{3} E_1 \cos(\phi - 150) + E_3 - E_4 \quad (14)$$

When  $E_2 = E_3 = E_4$

$$E_{c2} \approx \sqrt{3} E_1 \cos(\phi + 150) \quad (15)$$

$$\text{and } E_{c3} \approx \sqrt{3} E_1 \cos(\phi - 150) \quad (16)$$

If  $E_1$  is larger than  $E_2$ ,  $E_3$  and  $E_4$ , the vectors are as shown in Fig. 3C and the approximate equations are

$$E_{c2} \approx E_2 \cos(\phi + 120) - E_4 \cos \phi \quad (17)$$

$$E_{c3} \approx E_3 \cos(\phi - 120) - E_4 \cos \phi \quad (18)$$

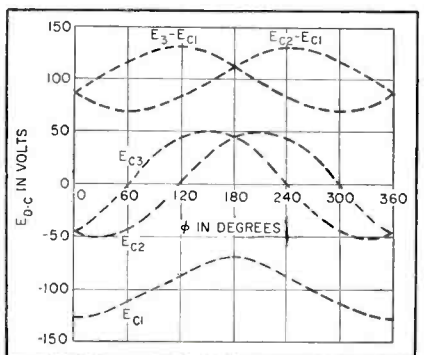

FIG. 4—Vectors of Fig. 3C as a function of phase-difference angle  $\phi$

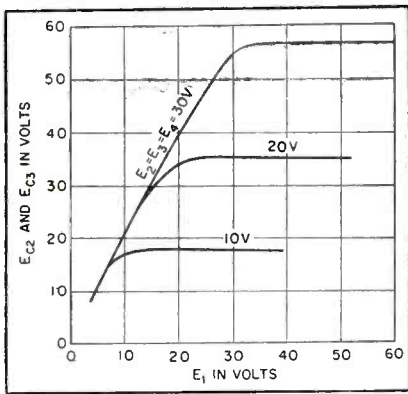

FIG. 5—Output characteristics of Fig. 3A

FIG. 6—Practical triple-diode phase detector and phase relationships

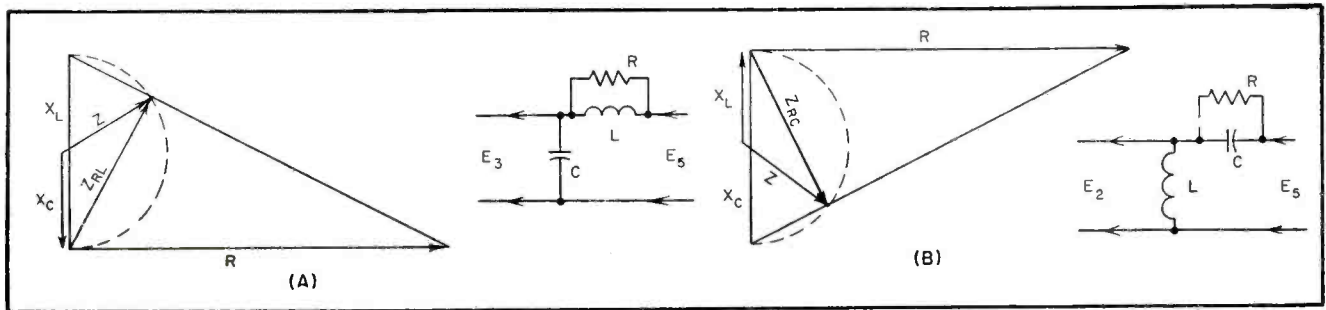
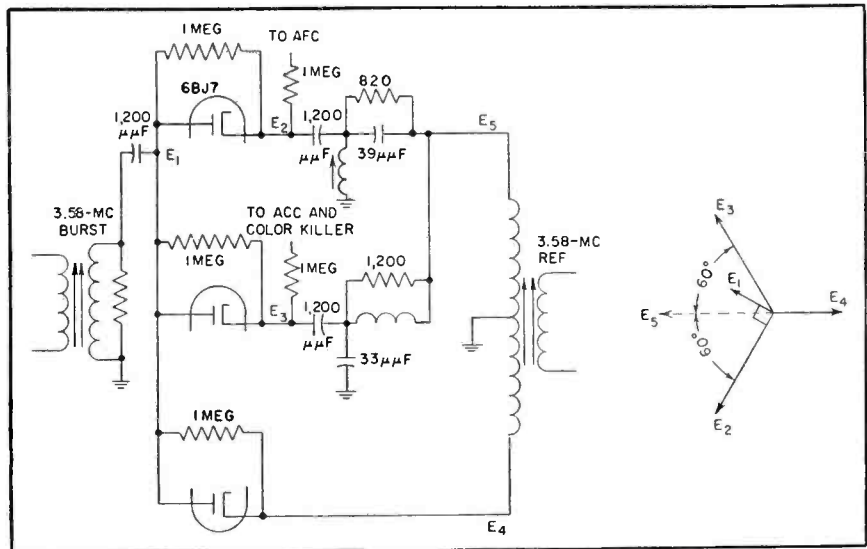

FIG. 7—Vector relationships of circuit in Fig. 6; phase-shifting circuit associated with each diagram is shown at its right

The relative efficiency (a-c input to d-c output) of the triple to the double-diode detector is  $\sqrt{3}/2$  or 0.866.

Referring to Fig. 3C and using Eq. 10, 15 and 16, a plot of  $E_{c2}$  and  $E_{c3}$  versus  $\phi$  is shown in Fig. 4. Note that  $E_{c2}$  and  $E_{c3}$  are 60 degrees out of phase. If  $E_{c2}$  is used for receiver afc and  $E_{c3}$  is used for acc and color killer, the point where  $\phi = 300$  degrees may be used. Here  $E_{c2}$  passes through zero voltage and  $E_{c3}$  is at 0.866 of maximum.

If  $E_1$  is the incoming 3.58-mc color burst and  $E_2$ ,  $E_3$  and  $E_4$  are the 3.58-mc locally generated c-w signals, it is necessary that the  $E_{c3}$  d-c output vary with the amplitude of  $E_1$  for acc and color-killer action. Figure 5 shows  $E_{c2}$  and  $E_{c3}$  as functions of  $E_1$  as  $E_2 = E_3 = E_4$  are varied. The knee occurs where  $E_1 = E_2 = E_3 = E_4$ . It is important, therefore, to operate the detector with  $E_1$  less than  $E_2$ ,  $E_3$  and  $E_4$ .

The noise immunity of the three-phase detector is excellent. With  $E_1$  at zero, 18 volts of noise peaked at 3.58 mc can be applied at the  $E_1$  in-

put. With  $E_2 = E_3 = E_4 = 50$  volts,  $E_{c2}$  and  $E_{c3}$  changes a maximum of one volt. This allows the color receiver's acc and color-killer action to remain effective with signal inputs as low as 20  $\mu$ v.

#### Circuit

The circuit, as used in a color receiver, is shown in Fig. 6. The incoming color burst is applied through a tuned coupling transformer to the plates of the three diodes at  $E_1$ . The 3.58-mc reference signal from the local oscillator is coupled through a tuned bifilar transformer and phase-split into  $E_2$  and  $E_3$  which are 180 degrees apart in phase and equal in amplitude. Voltage  $E_4$  in turn is phase shifted  $\pm 60$  degrees to derive  $E_2$  and  $E_3$ .

The 60-degree phase shifters are noncritical, low-impedance circuits, Figure 7 shows the vectors involved.<sup>2</sup> As  $R$  is varied in Fig. 7A, parallel R-L combination impedance  $Z_{RL}$  varies as the locus shown in the dashed line. If  $X_L = 2X_C$ , the total impedance  $Z$  of the circuit is of constant magnitude, equal

to  $X_C$  and varies from  $-90$  degrees through zero to  $+90$  degrees as  $R$  is varied from zero to infinity. Voltage  $E_3$  is therefore equal to  $E_5$  and lags it in phase from zero to 180 degrees.

The 60-degree lead network is shown in Fig. 7B. Here  $X_C = 2X_L$  and  $E_2$  can lead  $E_5$  from zero to 180 degrees.

A triple-diode phase detector was installed in a color receiver and its performance compared to a production-model color set.<sup>3</sup> The latter uses an ordinary back-to-back, double-diode, balanced phase detector for afc. Table I shows comparison of the parameters affecting afc.<sup>4</sup>

The author acknowledges the assistance of J. Hollywood, F. Weinstein and S. Yusem.

#### REFERENCES

- (1) D. Richman, The D-C Quadricorrelator: A Two-Mode Synchronization System, *Proc IRE*, p 288, Jan. 1954.
- (2) Chance, "Waveforms", *MIT Rad Lab Series*, Vol. 19, p 139, McGraw-Hill Book Co., New York, N. Y., 1949.
- (3) Rider TV Manual, Vol. 16, CBS-Columbia, p 15.
- (4) D. Richman, Color-Carrier Reference Phase Synchronization Accuracy in NTSC Color Television, *Proc IRE*, p. 106, Jan. 1954.

# TRANSISTOR-MAGNETIC

**SUMMARY** — Four-quadrant analog multiplication is performed by instrument that uses magnetic cores and junction transistors instead of electron tubes. One input variable controls amplitude of a square wave while a second variable governs the phase. Multiplication of variables is achieved by averaging the resulting square wave. Linearity is within 3 percent with 10 degrees phase shift at 100 cps

By **GLENN L. KEISTER**

*Boeing Airplane Company  
Seattle, Washington*

**V**OLTAGE MULTIPLICATION in airborne control systems is generally accomplished by a servo-driven potentiometer. This paper describes a four-quadrant voltage multiplier developed for possible airborne application. It uses only magnetic cores and transistor switches.

The main features of the multiplier are simplicity of operation, single-ended inputs and output, single d-c supply voltage, small size and low power consumption. Prototype tests indicate an output error of less than  $\pm 3$  percent of full scale can be maintained from room temperature to 150 F using germanium transistors.

## Theory of Operation

Multiplication is accomplished by averaging a square wave with an amplitude proportional to one voltage and a time difference between two half cycles proportional to another voltage. Figure 1A indicates how multiplication is performed. Pulse amplitude is made proportional to the X input by sampling the X voltage with a transistor chopper in the modulator.

By coupling the modulator to the demodulator with a centertapped transformer, the ground reference is shifted so that input voltage

polarity is transformed into a phase-sensitive signal at the input of the demodulator. The demodulator output is thus sensitive to both the X input voltage polarity and the demodulator switching signal phase which is controlled by a saturable reactor.

By making the phase of the demodulator switching signal proportional to the Y voltage input, the demodulator output becomes a square wave with an amplitude proportional to the X voltage input and the difference of the positive and negative half-cycle widths proportional to the Y voltage. The square wave switching signals are

supplied by a transistor magnetic-core oscillator.<sup>1</sup>

Figure 1B illustrates voltage multiplication. The first cycle shows the output waveform for Y equal to zero. For the second cycle the Y voltage is not equal to zero. The areas under the positive and negative pulses are

$$A^+ = V_x(t_0 - kV_y t_0) \quad (1)$$

$$A^- = V_x(t_0 + kV_y t_0) \quad (2)$$

where  $t_0$  is the time for one quarter cycle of the oscillator and  $k$  is a constant of the magnetic circuit. The net difference in area obtained by filtering appears as the output voltage.

Therefore

$$V_o = A^+ - A^- \quad (3)$$

$$= 2kV_x V_y t_0 \quad (4)$$

$$V_o = KV_x V_y \quad (5)$$

## Transistor Switch

The impedance between the emitter and collector of a fused-junction transistor approaches that of a relay contact when a switching signal is applied between emitter or collector and base. In a *pn*p transistor with an emitter-to-base voltage of a few tenths volt positive, the on impedance is of the order of one ohm, while the off impedance with a few tenths volt negative is of the order of one

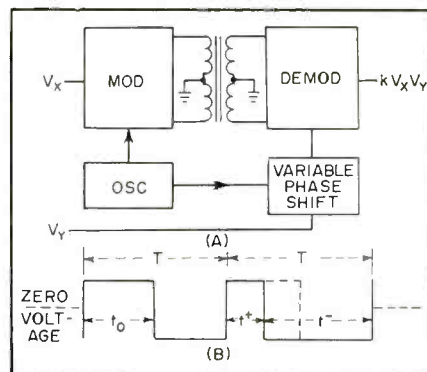
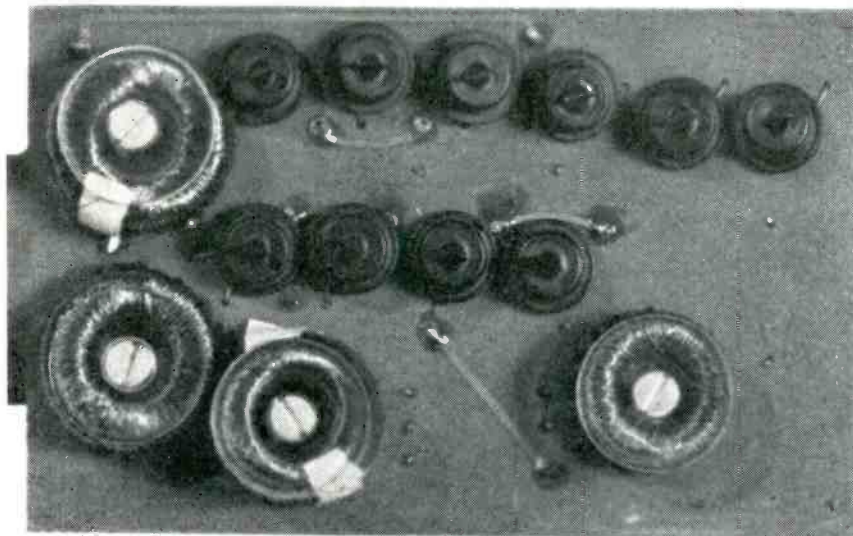

FIG. 1—Block diagram of analog multiplier (A) and waveforms for square-wave multiplication (B)

# ANALOG MULTIPLIER



Prototype transistor-magnetic analog multiplier requires 250 mw from 12-v supply

megohm. Since the transistor is a current device, the operation of the transistor switch may be defined by the collector and base currents.<sup>2</sup>

A rule of thumb for signals of the order of one volt is to maintain the collector-to-base current ratio less than or equal to one for closed-switch or current-saturated condition. For the open-switch condition the emitter-to-base voltage should be greater than or equal to one-half volt.

In addition to the on and off impedance of the switch, consideration must be given to the current, voltage, power, frequency and temperature limitations of the transistors. In the current-saturated condition the current is limited by the power dissipation of the transistor. For a 150-mw transistor this is generally around 100 ma.

The switch is limited in the off condition by the voltage breakdown of the collector or emitter diode. Since the base is maintained at a positive voltage, with respect to both collector and emitter, all the leakage current is supplied through

the base. Therefore, no leakage-current multiplication occurs, as would be the case if part of the collector diode leakage current were to flow through the emitter.

## Power Dissipation

The power limitation of the switch is the rated power dissipation of the transistor. Due to the 1 to 2-sec thermal time constant of most transistors the power dissipated is the average power per cycle for frequencies greater than a few cps. The power dissipated in the transistor switch is the sum of the average switching power, the average signal power dissipated in the switch and the average power dissipated in the transition from the on to off condition.

Since the transistor is almost always in a low power dissipation condition it can control much larger powers than it is rated to dissipate.

The effect of increased ambient temperature is to reduce the rated power dissipation and off impedance, and to shorten the useful life of the transistor. Not only does

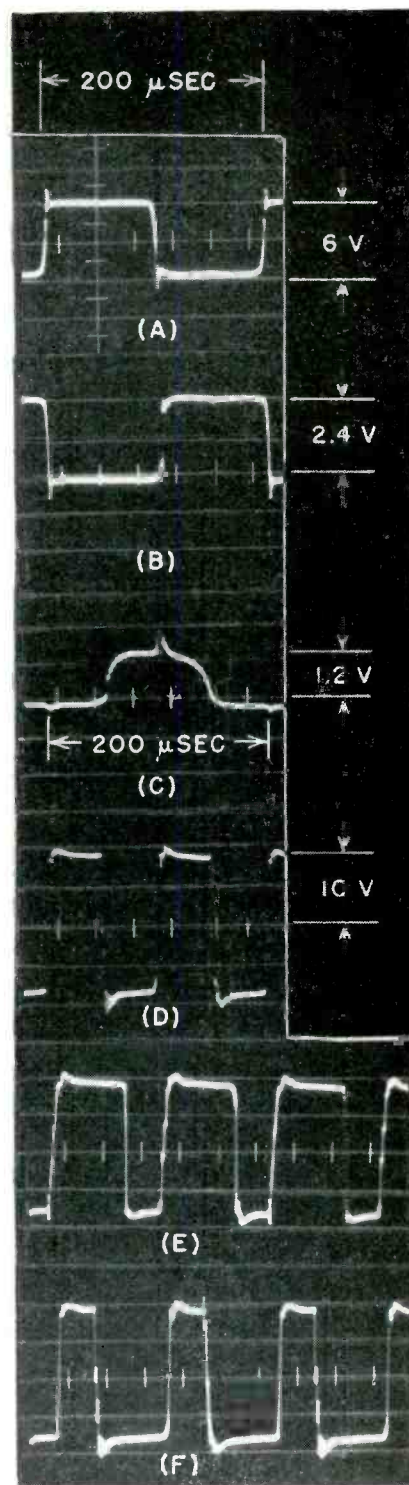

Multiplier voltage waveforms: oscillator signal (A), modulator switching signal (B), demodulator switching signal (C), unfiltered output for  $V_X = 10$  v,  $V_Y = 0$  (D), output for  $V_X = V_Y = 10$  v (E) and for  $V_X = 10$  v,  $V_Y = -10$  v (F)

the rated power dissipation of a transistor decrease with temperature, but the total power dissipated in the transistor increases due to increased leakage. This can result in an unstable condition known as thermal runaway.

The efficiency of the transistor switch is so high that considerable liberties can be taken in its design. It is generally only in critical applications that careful design and transistor selection are necessary.

### Switch Design

The switches used in the multiplier circuit consist of two 2N43 transistors back-to-back because of the necessity of blocking voltages of both polarities. These switches are designed to switch a maximum current of 5 ma. The base current is limited to approximately 5 ma by the resistors in series with the switching voltage.

If the  $X$  voltage is limited to 10 volts, the switches must block 22.4 volts because of the induced voltage in the coupling transformer and the reverse voltage bias on the base. The average dissipation for the ten transistors in the multiplier is approximately 10 mw. Since the allowable room temperature dissipation is 150 mw, the ambient temperature can be increased considerably before maximum power dissipation is reached.

### Timing Oscillator

Using the transistor switches in the chopper modulator, square-wave modulation of the input signal can be obtained for frequencies as high as 5 or 10 kc. The demodulator, which is identical with the modulator, is coupled to the latter by a centertapped transformer. This coupling transformer must be broadband to maintain the shape of the output square wave.

The switching signal for the transistor switches is supplied by a transistor oscillator that utilizes a magnetic material and a pair of transistor switches. The saturation of the magnetic material limits the oscillation by breaking the feedback coupling. The output is a square wave having a frequency

$$f_s = V/4N_s\phi$$

where  $V$  is the supply voltage,  $N_s$

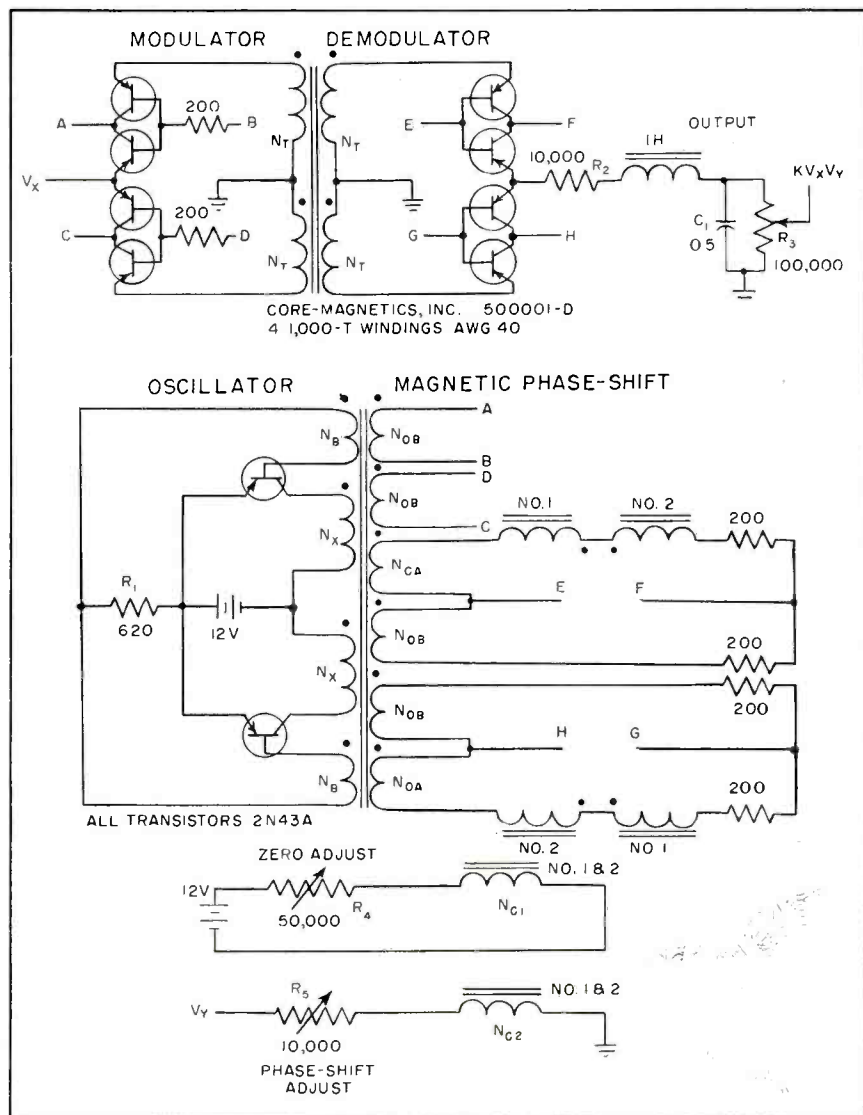

FIG. 2—Circuits of transistor-magnetic multiplier include oscillator, modulator, demodulator and magnetic phase-shifter

the number of turns on the primary of the transformer and  $\phi$  is the saturation flux of the core material. To reduce the induced voltage peaks that appear across the transistor at the beginning of each cycle, it is best to use square-loop magnetic material, such as Hymu or Orthonol in toroidal form.

Since  $N_s$  and  $\phi$  are fixed, the frequency is dependent on the supply voltage. Since the multiplier output voltage is a function of the switching frequency, the oscillator must have a well regulated power supply to minimize the drift in the output voltage.

### Magnetic Phase Shift

The phase shift for the demodulator switching signal is obtained by the saturable reactor shown in

Fig. 2. During the first half cycle of the oscillator, the switching voltage is determined by the voltage across coil  $N_{OB}$  because of the high reactance of the series reactors.

At some time during the first half cycle the reactor will saturate. Since the voltage across coil  $N_{OA}$  is greater than across coil  $N_{OB}$ , the switching voltage polarity will change. By varying the d-c ampere-turns bias the phase or time of reactor saturation can be controlled.

The saturable reactor is designed so that it will be saturated by one-half cycle of the oscillator switching voltage. The saturation time is adjustable over the complete half cycle in a linear fashion by a voltage applied to one of two control windings that are wound common to the two reactors.

One control winding is used to



adjust the multiplier for zero output by setting the saturation time to exactly one quarter cycle for the oscillator. The second control winding is used for the Y signal and is adjusted to give a shift in saturation time proportional to the Y voltage.

This type of low-gain saturable reactor requires selection of a control-to-reactor turns ratio and control-circuit resistance which will insure a linear variation of reactor saturation time with control voltage. This means that the control-circuit resistance reflected into the phase-shift circuit must be small relative to the phase-shift circuit impedance. This choice involves a compromise since the response time of the phase-shift reactor is also proportional to the control-to-reactor turns ratio. A ratio of 40 to 1 was found to give a satisfactorily linear range, with an error of  $\pm 3$  percent of full scale and a phase shift of 10 degrees at 100 cps with an oscillator frequency of 5 kc.

A parallel self-saturating magnetic circuit with series diodes was tried in place of the series saturable reactor but the increased voltage gain made the circuit much less stable to variations in the supply voltage. This variation of the multiplier circuit could be used to advantage where voltage gain is required.

The design information for the magnetic circuit is related directly to the requirements of the oscillator. For a supply voltage of 12 volts, oscillator frequency of 5,000 cps, and Magnetics, Inc. core 50056 1-D, the windings should be:  $N_x = 175$  turns,  $N_b = 0.1 N_x = 17$  turns,  $N_{oa} = 0.4 N_x = 70$  turns,  $N_{ob} = 0.2 N_x = 35$  turns,  $N_c = (N_{ob} + N_{or})/2 = 52$  turns and  $N_e = 40 \times 52 = 2,000$  turns.

### Experimental Operation

The complete schematic diagram of the multiplier shows the inter-relationship of the various units: the transistor modulator and demodulator appear at the top with the oscillator and phase-shifting circuits in the center and the phase-shift controls at the bottom. There are three adjustments to be made before the multiplier is ready for operation.

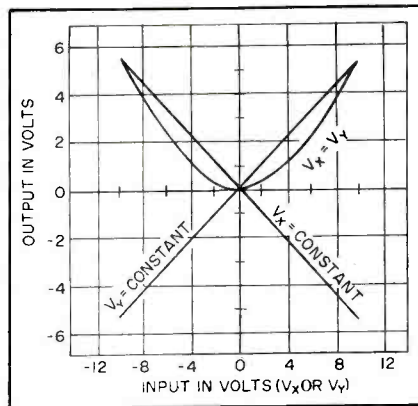

FIG. 3—Output characteristics of multiplier demonstrate its linearity

With a signal at the X input,  $R_4$  is adjusted for zero output voltage. Next  $R_5$  is adjusted to give the most linear output. Since the zero is affected by this adjustment, a second adjustment of the zero may be necessary.

For a particular application  $R_5$  can be replaced by a fixed resistor. When the linearity adjustment is optimized, the output voltage can be set to the desired value by the variable resistance of the output filter.

The output wave shape and thus the zero and linearity of the multiplier are affected by the X input driver impedance. Although the X input impedance is 20,000 ohms, it is necessary to have a driving source with an output impedance of approximately 500 ohms to obtain a suitable output wave shape.

The oscilloscope photographs show the output and switching signal waveform as they appear in time with reference to the oscillator signal. Since the switching signals appear between base and collector, the low voltage represents the on condition and the large voltage the

off condition. Although the demodulator switching signal does not have a fast rise time, the active nature of the transistor sharpens the output waveform.

The oscillations on the output waveform are a function of the input and output reactances of the coupling transformer and the resistance damping of the circuit. Typical characteristics of a realizable design are  $\pm 10$  v in each input,  $\pm 5$  v out for  $\pm 10$  volts in, linearity of  $\pm 3$  percent of full scale, 10 deg phase shift at 100 cps and good stability with changes in ambient temperature from room temperature to 150 F.

The photograph shows a prototype multiplier and demonstrates its small size. A total of 250 mw is required from a single 12-volt power supply. The linearity of the multiplier is shown in Fig. 3 for an oscillator frequency of 5,000 cps. A more linear output can be obtained by reducing the oscillator frequency which improves the output waveform. Temperature characteristics are given in Fig. 4.

By using transistor switches and saturable reactors, an analog voltage multiplier has been devised. Its simplicity of construction and operation, its small size and low power consumption as well as its stability of operation both at room temperature and at elevated ambient temperatures make it attractive for airborne applications.

The linearity of the multiplier can be improved if a narrower passband can be tolerated. By including the oscillator as an integral part of the multiplier, it can be operated from a single source of direct current.

The author thanks K. D. Johansen for his discussions and suggestions on the magnetic circuit and Dale Jenkins for aid in construction and testing of the prototype.

### REFERENCES

- (1) G. H. Royer, A Switching Transistor D-C to A-C Converter Having an Output Frequency Proportional to the D-C Input Voltage, *Trans AIEE*, Paper No. 55-73, Feb. 1955.
  - (2) J. J. Ebers and J. L. Moll, Large Signal Behavior of Junction Transistors, *Proc IRE*, 42, No. 12, p. 1,761, Dec. 1954.
- R. L. Van Allen, Four Quadrant Multiplication with Transistors and Magnetic Cores, *Trans AIEE*, Paper No. 55-461, June 1955.

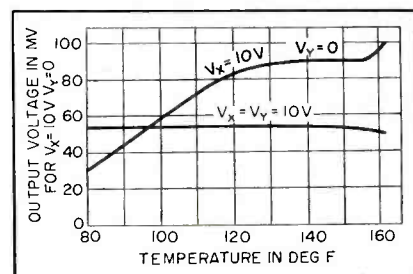

Fig. 4—Temperature characteristics illustrate good stability to 150 F

**SUMMARY** — Pulses at constant repetition rate are integrated producing stairstep function for comparison with modulation signal in difference circuit. Pulse transmission stops when stairstep exceeds modulation and negative pulses automatically reach local receiver, in feedback loop with transmitter, to reverse integration process. When stairstep level is below modulation, pulses are again transmitted producing pulse train capable of providing satisfactory voice communication

# Transmitting System

By R. B. WATSON and O. K. HUDSON\*

*Department Of Physics  
University of Texas  
Austin, Texas*

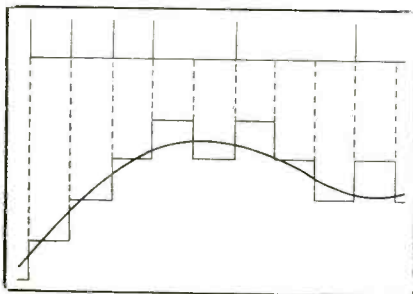

FIG. 1—Stairstep integration shows approximation to modulation

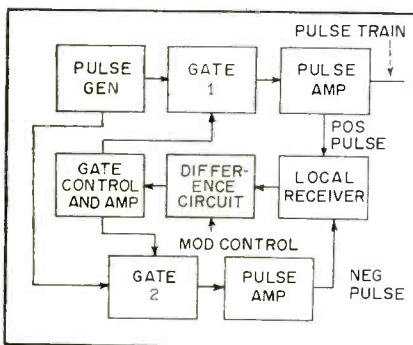

FIG. 2—Block diagram of delta modulation system

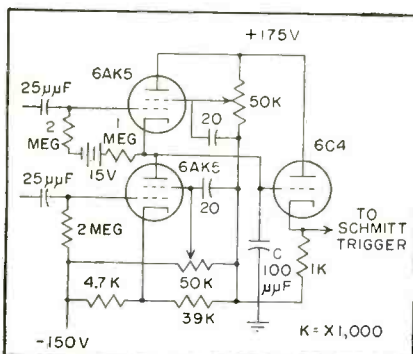

FIG. 3—Single-integrating local receiver detector generates stairstep function

**D**ELTA MODULATION is a coded pulse-modulation system employing a train of equally spaced, identical pulses transmitted only when the magnitude of the output from a local receiver, within the transmitter, falls below the modulation signal to be transmitted.

The local receiver is placed in a feedback loop in the transmitter. It is supplied with the transmitted pulses and pulses of the opposite polarity, whenever the transmitted pulses are absent. The pulse train at the receiver is integrated to form a stairstep function as shown in Fig. 1.

The stairstep function is compared to the modulation signal in a difference circuit. When it is greater than the modulation, no pulses are transmitted and pulses of opposite polarity reach the receiver. When it is less than the modulation, pulses are transmitted and reach both the local and any remote receiver. Thus the local receiver output approximates the modulation signal in a stepwise manner and the train of transmitted pulses is a measure of the modulation signal.

The transmitter consists of a pulse generator, two gates to control the passage of pulses, a local receiver, a difference circuit, a gate control circuit and amplifiers. Referring to the block diagram of Fig. 2, when gate 1 is open, positive pulses are transmitted and also reach the local receiver. Its positive stairstep output is compared with the modulating signal in the difference circuit and if the difference between the stairstep and modulation signal is negative, gate 1 remains open and transmitted pulses continue to reach the local receiver causing the difference to approach zero in a stepwise manner.

If the difference becomes positive, gate 1 is closed and gate 2 is opened, allowing negative pulses to reach the receiver, causing the difference to approach zero again.

The pulse generator is a conventional unit producing 100,000 pps. The gate circuits employ 6BN6 tubes. Switching voltages for these tubes are derived in the difference circuit using a Schmitt trigger. The trigger circuit is controlled by the difference between the stairstep function from the local receiver and the applied modulating signal. Amplifiers in the gate control isolate

\* Now with Dowell Inc., Tulsa, Okla.

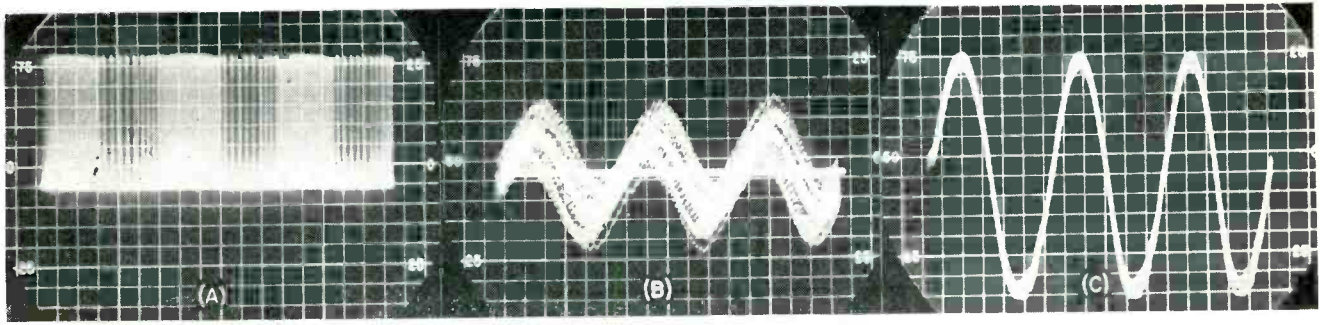

Waveshapes show pulse carrier nearly fully modulated by 1,000 cps sine wave (A), staircase function at remote receiver detector with jitter caused by unstable power supply (B) and output of double-integrating detector (C)

# Uses Delta Modulation

the trigger circuit from the gates and also provide proper polarity of switching voltages for the gates.

The local receiver generates the staircase function by charging or discharging a storage capacitor through two pentode constant-current generators. For each pulse, the proper generator adds a fixed increment of charge to the capacitor. The capacitor thus exhibits the staircase voltage used for comparison at the Schmitt trigger circuit. The capacitor charging circuit is shown in Fig. 3.

A second type of local receiver detector makes use of two integrations of the pulses applied to the local receiver to provide a comparison signal having a discontinuous slope instead of discontinuous magnitude. Capacitor  $C_1$  of Fig. 4 produces the first integration and  $C_2$  produces the second. This local

receiver output gives a better approximation to the modulation signal.

## Remote Receiver

The remote receiver detector shown in Fig. 5 operates much like the local receiver at the transmitter. Whenever transmitted pulses are received,  $C$  is charged through the pentode tube. In the absence of transmitted pulses, negative pulses are not available to discharge the capacitor. Instead, it is continuously discharged through a shunt resistor and the waveform does not have staircase form, but is made up of short sections of exponential transients separated by abrupt charging transients. By proper choice of the R-C time constant the output satisfactorily reproduces the original modulation signal.

The use of a stepwise approximation to the modulating signal produces quantizing noise. This approximation also produces a threshold effect; the modulation signal must have a minimum amplitude before it can control the transmitter.

When the modulating frequency becomes sufficiently high the system produces periodic errors and an additional tone is heard. The frequency of this extra tone varies with the modulation frequency, passing through zero in the manner of a heterodyne beat note. The lowest frequencies for which beating occurred were 3 kc for the detector of Fig. 3 and 1 kc for the detector of Fig. 4. The maximum number of quantum levels available for transmission decreases with increasing modulation frequency in a hyperbolic manner. When the

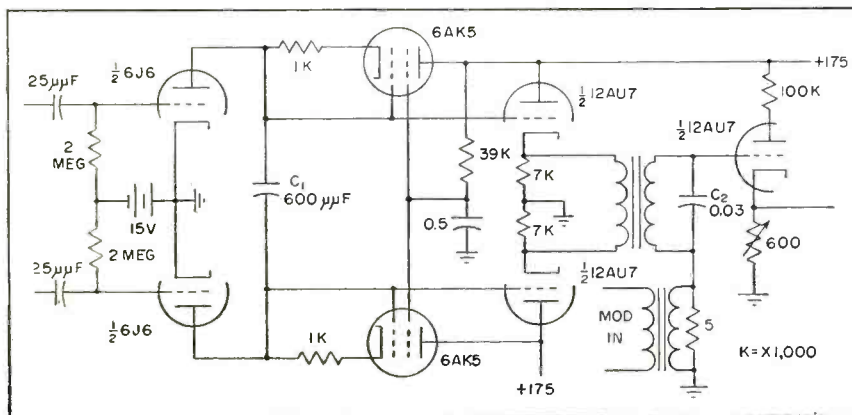

FIG. 4—Double-integrating local receiver detector approximates modulation signal

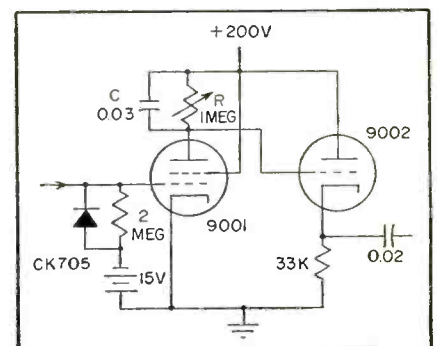

FIG. 5—Detector used in remote receiver operates in same manner as local receiver at transmitter

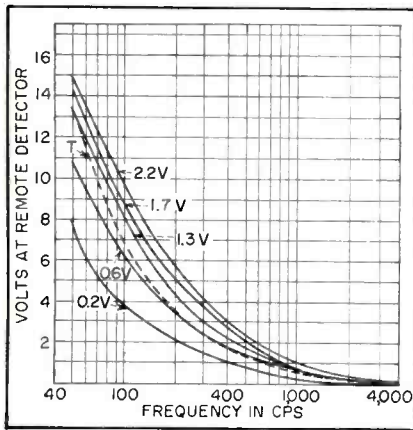

FIG. 6—Output characteristics of single-integrating detector

modulation voltage is so large that nearly all the quantum levels are used, the system begins to make periodic errors.

### Frequency Response

The frequency response is limited by the fact that the number of levels available for approximating a given signal is limited by the frequency and amplitude of the signal. Suppose the signal is to be approximated by a train of pulses occurring at a rate of  $f_c$  pulses per sec, of amplitude  $e$ .

The detected signal changes most rapidly when all pulses are transmitted and the instantaneous magnitude at the detector is on the average  $f_c e t$  at any time  $t$ . The rate of change of this signal or the maximum slope of the approximating curve is  $f_c e$ . It is assumed that this slope matches the maximum slope of a sinusoidal signal hence

$$d/dt (A_m \sin \omega_m t)_{\max} = f_c e, A_m \omega_m = f_c e \text{ and } A_m/e = f_c/f_m/(2\pi)$$

Thus for the pulse repetition frequency of 100 kc and the modulation frequency of 1,000 cps,  $A_m/e$  is about 16. Accordingly the maximum possible amplitude of the modulating signal, for best theoretical reproduction is 16 times the pulse height or the maximum number of levels or quanta in the received signal is 16.

As the modulating frequency decreases, the amplitude that may be transmitted increases rapidly since the number of available levels increases similarly. The shape of the limiting curve of amplitude versus modulation frequency is shown in Fig. 6 as curve *T*. This curve is

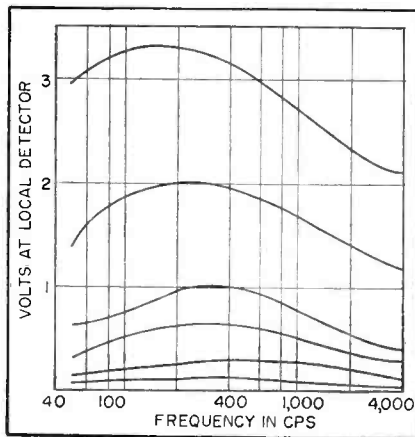

FIG. 7—Frequency response of double-integrating detector

based on the formula  $A_m = K/f_m$  where  $K$  is a constant obtained by letting  $A_m = 15$  v at 50 cps. Whenever the permitted number of levels is exceeded, overmodulation exists. The effect is to replace a segment of a given curve, whose slope is greater than the maximum permitted slope, with a chord having the maximum permitted slope and passing through the end points of the segment. The output waveform approaches a zig-zag curve in the limit.

The normal frequency response depends on whether single or double integration is used at the detector. In the local and remote detectors essentially single integration is used. The experimental frequency response of this type of detector is illustrated in Fig. 6.

The voltage derived from the detector is inversely proportional to the frequency as

$$|Z| = R/[1 + (\omega RC)^2]^{1/2}$$

Therefore  $|Z| \propto \frac{1}{\omega}$  if  $(\omega RC)^2 \gg 1$ . A typical value at the remote detector is:  $R = 0.5$  megohm and  $C = 0.03 \mu f$  so  $\omega RC = 2\pi f(0.015) = 0.1 f$ . If  $(\omega RC)^2 = 10$ , then  $f = 30$  cps satisfies the inequality by a factor of 10, so that above 30 cps the approximation is satisfactory. This analysis is proper since the output voltage is proportional to the impedance when a constant current source is used. For the single integration local detector of Fig. 3 the condition is rigorously valid since  $R$  approaches infinity.

Good agreement is observed between experiment and theory as shown in Fig. 6. Experimental

points below 100 cps are low owing to the poor frequency response of the vacuum tube voltmeter used. The data for Fig. 6 were taken at the remote receiver. The measured frequency response was nearly identical for the local receiver detector of Fig. 3.

The measured frequency response of the receiver detector of Fig. 4 is shown in Fig. 7. Lack of response for frequencies below 100 cps is attributed to the coupling transformer. The effect of double integration is the same as that of adding a low-pass filter to a single integration system, producing no essential change in the frequency characteristic.

### Dynamic Range

The dynamic range of delta modulation is limited at high levels by the process just described and is limited at low levels by the threshold effect. The dynamic range is thus proportional to the maximum number of levels available at a given frequency.

There exists an optimum value of time constant of integration at the remote receiver. When the time constant is too large the signal output is reduced. As the time constant is made smaller, output at first increases without change of quantization noise. Thereafter quantization noise increases without increase of signal output. For all measurements, the time constant was set for maximum output without increased quantization noise.

The data taken on the experimental model show that satisfactory voice communication is possible with a pulse repetition rate of 100,000 pps. Higher modulation frequencies may be transmitted if a higher pulse repetition rate is used.

Delta modulation has the characteristics of any pulse-code-modulation system plus the advantage of simplified encoding and decoding. The system may find unique application as a possible modification to a radar to provide communication channels.

### BIBLIOGRAPHY

- Libois, L. J., Un nouveau procédé de modulation codée. La modulation en  $\Delta$ , Onde Electrique, p 26, Jan. 1952.  
Schouten, Jager and Greefkes, Delta Modulation, Philips Technical Review, p 237, Mar., 1952.

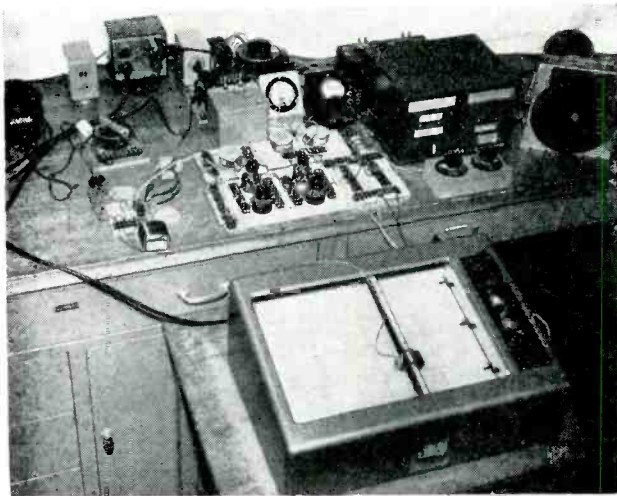

Breadboard model of magnetic-switch dynamic hysteresis curve plotter with a B-H curve shown on the plotting board. Two light-spot galvanometers are shown at right

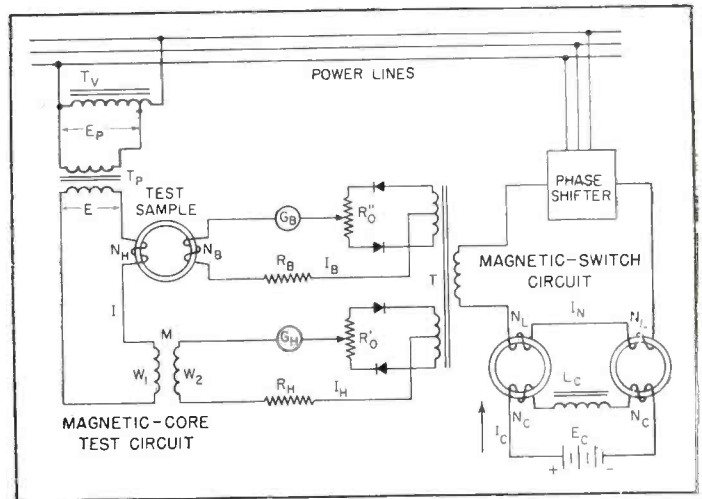

FIG. 1—Magnetic-switch B-H loop tracer for point-to-point plotting uses two silicon junction diode chopper circuits. Galvanometers show magnetic-field intensity and flux density

# MAGNETIC-SWITCH B-H Loop Tracer

By WILLIAM GEYGER

U. S. Naval Ordnance Laboratory  
Silver Spring, Maryland

**SUMMARY** — Silicon junction diode chopper circuits synchronously operated from a magnetic switch replace phase-sensitive mechanical rectifiers in instrument that traces dynamic hysteresis loops of magnetic materials at supply frequencies as high as 20,000 cps. The B-H loop tracer uses no electron tubes and can provide for either point-to-point loop tracing or automatic recording using an x-y plotter

**S**IMPLEST FORM of the magnetic-switch B-H loop tracer uses two silicon-diode bridge-type half-wave chopper circuits as shown in Fig. 1. The magnetizing primary winding  $N_H$  of the test core is series-connected to the primary winding  $W_1$  of an air-core transformer with mutual inductance  $M$ . Magnetizing current  $I$  is derived from a three-phase power supply through variable transformer  $T_V$

and step-down transformer  $T_P$ .

Secondary windings  $W_2$  and  $N_B$  are connected to moving-coil galvanometers  $G_H$  and  $G_B$ , resistors  $R_H$  and  $R_B$ , and silicon-diode chopper circuits with balance potentiometers  $R_o'$  and  $R_o''$ . These circuits are supplied with current  $I_N$  from a saturable reactor having rectangular-hysteresis-loop core material, series-aiding a-c load windings  $N_L$  and series-opposing d-c control

windings  $N_C$ . The wave shape of  $I_N$  is nearly rectangular since the control-circuit loop carrying constant direct current  $I_o$  presents a high impedance, choke  $L_C$ , to even-harmonic currents.

The synchronously operated silicon junction diodes have a comparatively low forward resistance, about 100 to 1,000 ohms, and a high reverse resistance, about 10 to 100 megohms. They close secondary

**Table I—Core and Winding Data for Saturable-Reactor Elements**

		Supply Frequency in cps	
		60	400
Core	Material	½ by 0.002-in. Ortholon tape	¼ by 0.002-in. Ortholon tape
	Size in in.	1¼ i-d 1⅝ o-d	1⅜ i-d 1⅝ o-d
	Awg Wire Size	No. 29	No. 28
Winding $N_L$	Turns	1,400	700
	Resistance in ohms	26	6
Winding $N_C$	Awg Wire Size	No. 29	No. 28
	Turns	700	350
	Resistance in ohms	12	4
Primary voltage from phase shifter = 38 v rms			

**Table II—Core and Winding Data for Current Transformer**

		Supply Frequency in cps	
		60	400
Core	Material	½ by 0.002-in. Supermalloy tape	¼ by 0.002-in. Supermalloy tape
	Size in in.	1¼ i-d 1⅝ o-d	1⅜ i-d 1⅝ o-d
	Awg Wire Size	No. 32	No. 28
Primary	Turns	48	24
	Resistance in ohms	0.8	0.1
Secondary	Awg Wire Size	No. 32	No. 28
	Turns	4×1,000	4×500
	Resistance in ohms	4×35	4×8
Primary current $I_N = 100$ ma ave			

circuits  $W_2$  and  $N_B$  during one half-cycle and open these circuits during the succeeding half-cycle. The phase shifter can vary the time interval or switching phase angle  $\alpha$  between closing of the switching circuits and the instant the secondary voltages go through zero.

**Measurement Principle**

The sinusoidal-flux test circuit measures the instantaneous values  $H_a$  and  $B_a$  of magnetic-field intensity and magnetic-flux density with various phase displacements  $\alpha$  between square-wave reference current  $I_N$  and power-supply voltage  $E_p$ . With any phase displacement between  $I_N$  and  $E_p$ , the average values of the unidirectional currents  $I_H$  and  $I_B$  given by galvanometers  $G_H$  and  $G_B$  are proportional to the instantaneous values of  $H$  and  $B$  if the B-H loop is symmetrical. That is, if the wave shape of magnetizing current  $I$  has neither d-c nor even-harmonic components. This assumption is valid for magnetic materials which are in cyclical magnetization and have no d-c component of flux.

If resistors  $R_H$  and  $R_B$  are sufficiently large then the following relationships can be used

$$I_{H_a} = H_a f_p M l / 0.2\pi N_H R_{HT} \tag{1}$$

$$I_{B_a} = B_a 2f_p N_B A / 10^8 R_{BT} \tag{2}$$

where  $f_p$  is the power-supply frequency;  $M$  is the mutual inductance;  $l$  is the length of the magnetic path in the test core;  $A$  is the effective cross-sectional area of the core;  $N_H$  and  $N_B$  are the numbers of turns on the core; and  $R_{HT}$  and  $R_{BT}$  are the total resistances of the secondary circuits of windings  $W_2$  and  $N_B$ .

The time variations of  $H_a$  and  $B_a$

can be measured point-by-point by varying the instant at which the chopper circuits close and noting the average values  $I_{H_a} = \text{constant} \times H_a$ , Eq. 1, and  $I_{B_a} = \text{constant} \times B_a$ , Eq. 2, indicated by the galvanometers at each setting of the phase shifter.

**Coercive Force and Remanence**

When the problem is to determine coercive force  $H_c$  and remanence  $B_r$  of the core for grading and matching of magnetic-amplifier cores, the average value of  $I_B$  can be made zero by the phase shifter. Galvanometer  $G_H$  will indicate coercive force  $H_c$  in oersteds. By adjusting the phase shifter, the average value of  $I_H$  can be made zero. Galvanometer  $G_B$  will indicate remanence  $B_r$  in gauss. Calibration of  $G_H$  and  $G_B$  may be accomplished by measuring peak values of known sinusoidal voltages derived from an auxiliary circuit.

To trace  $B_a = f(H_a)$  using the point-by-point method, numerous average values of  $I_{H_a} = \text{constant} \times H_a$  and  $I_{B_a} = \text{constant} \times B_a$  can be computed at each setting of the phase shifter.

Another possibility is to trace the B-H loop with a high-speed x-y recorder.<sup>1</sup> To reproduce  $B_a = f(H_a)$  on the chart, the rotor of the phase shifter may be moved slowly, preferably by a motor with speed-reducing gear train.

When reproducing dynamic B-H loops by x-y plotter, the phase shifter may be replaced by an electron-tube oscillator or a switching-transistor d-c to a-c converter, the frequency of which is slightly lower or higher than power-supply frequency  $f_p$ .

With the operating frequencies 60 and 60.04 cps, the pen will trace the B-H loop in 25 seconds and with 400 and 400.025 cps, the loop will be traced in 40 seconds. This proce-

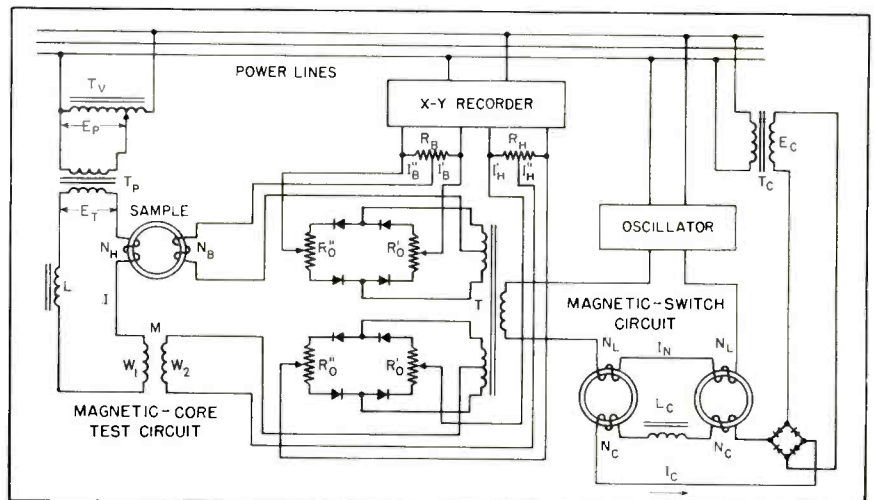

**FIG. 2—Loop tracer for automatic recording with high-speed x-y plotter employs two silicon junction diode full-wave ring modulators acting as synchronous commutators**

ture is a heterodyne method because the cycling of the pen is determined by the beat frequency which can be controlled by varying the frequency of square-wave reference current  $I_N$ .

Figure 2 illustrates replacing the half-wave bridge circuits of Fig. 1 by two full-wave silicon-junction-diode ring modulators acting as synchronous commutators. Input channels of the x-y recorder are connected across center-tapped resistors  $R_H$  and  $R_B$  and the magnetic switch is excited from an oscillator. The d-c control circuit of the saturable reactor is supplied from full-wave selenium rectifier.

When using a galvanometer-type x-y recorder<sup>1</sup>, in which a pair of two-phase induction motors are separately controlled by two moving-coil galvanometers, the input channels may be directly connected through resistors. However, use of a chopper-type x-y recorder makes it necessary to eliminate the even-harmonic a-c components of unidirectional currents  $I_H'$  and  $I_H''$ , and  $I_B'$  and  $I_B''$  by two equally rated filter circuits, Fig. 3.

The circuit of Fig. 2 is based upon a sinusoidal-current test. Primary windings  $N_H$  and  $N_B$ , series-connected with a large linear reactor  $L$ , carry the nearly sinusoidal magnetizing current  $I$ . The waveform of magnetic flux in the core will be highly distorted.

### Switching Performance

The duration of phase reversal through the phase-sensitive rectifiers is exactly equal to 180 deg since each half-cycle of alternating current  $I_N$  is inherently equal to that of the succeeding half-cycle. Correct operation also requires that each of the silicon-diode bridge circuits be balanced.

The center taps of the secondary windings of current transformer  $T$  and the sliders of potentiometers  $R_o'$ ,  $R_o''$  must represent equipotential points. After zero adjustment of  $I_H$  and  $I_B$  with no-signal conditions, no error voltage will be injected from these points into the secondary circuits of  $W_2$  and  $N_B$ .

To increase zero stability, square-wave forward currents of the silicon diodes should be minimized. However, these reference currents

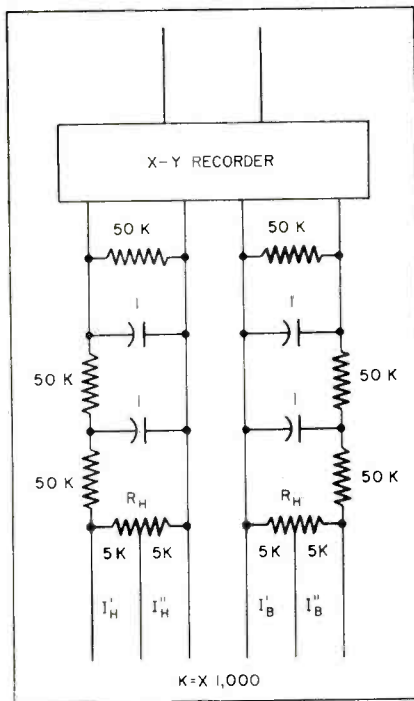

FIG. 3—Filters used with chopper-type x-y recorder

must be sufficiently large compared to the peak values of signal currents  $I_H$  and  $I_B$  to avoid saturation of the chopper circuits. When employing light-spot galvanometers for testing small core samples, zero stability in the order of  $10^{-20}$  watt or better at room temperatures can be achieved<sup>2</sup> by reducing the silicon-diode forward currents, derived from the constant-current source  $I_N$ , to about 200 to 800 microamperes.

### Experimental Results

Magnetic-switch B-H-loop tracers can be built using commercially available components. Test windings having only a few turns, for example  $N_H = 4$  and  $N_B = 5$ , are applied to the test core by miniature 9-pin plugs.

Tables I and II give core and winding data for saturable-reactor elements and current transformer  $T$  for 60 and 400-cps power-supply frequencies.

The validity of Eq. 1 and 2 requires that the loading of secondary windings  $W_2$  and  $N_B$  by the galvanometer circuits have no appreciable effect on the galvanometer indications. When testing large cores and using panel-type moving-coil microammeters, the power values  $E_H^2/R_{HT}$  and  $E_B^2/R_{BT}$  may be in the order of 0.1 to 1 microwatt

without excessive loading. For testing small cores, these power values may be reduced to about  $10^{-8}$  watt or less by using fast-response light-spot galvanometers.

To check operation of the system, the test-core may be replaced by an air-core transformer. Two pure mutual inductances are then compared and the result of the point-by-point measurement or x-y recording will be a straight line through the origin.

The photograph shows the 60-cps B-H loop of an Orthonol 2-mil tape core, i-d = 1½ in., o-d = 2½ in., tape width = 1.0 in., obtained by sinusoidal-flux testing. This diagram was recorded in about 30 seconds with a hand-operated phase shifter. The B-H loop of this core having a comparatively small i-d/o-d ratio displays a double-peak deformation at the beginning of flux reversal.

The resolution power is excellent. After calibration by measuring peak values of known sinusoidal voltages, an overall accuracy of  $\pm 1$  to 2 percent can be expected. With power-supply frequencies up to about 20,000 cps, the conventional techniques for dealing with capacitive currents and magnetic stray fields must be employed.

### Other Applications

The magnetic-switch B-H-loop tracer may also be used for point-by-point measurement and recording of other dynamic characteristics.<sup>3</sup> Another possibility is measuring and recording the time functions of  $H$ ,  $B$  and  $dB/dt$ , or other symmetrical waveforms<sup>4</sup> of a-c circuits. The system produces an immediate, direct and permanent record, not requiring subsequent photographic processing.

### REFERENCES

- (1) W. A. Geyger, Alternating-Current Hysteresis Loop Recording by Means of an Ink-type X-Y Recorder, *Archiv fur Technisches Messen (ATM)*, Germany, Section V 951-3, May 1938.
- (2) N. F. Moody, A Silicon Junction Diode Modulator of  $10^{-8}$  Ampere Sensitivity for Use in Junction Transistor Direct-Current Amplifiers, *Proc NEC*, Chicago, Ill., 11, p 441, Oct. 1955.
- (3) W. A. Geyger, Ink-Recorder Vector Meter for Automatic Recording of Alternating-Current Characteristic Curves, *Archiv fur Technisches Messen (ATM)*, Germany, Section J 036-5, Oct. 1937.
- (4) W. A. Geyger, Determination of Waveforms, Point-by-point Measurement With Rectifiers Acting as Synchronous Switches, and Automatic Recording of Waveforms, *Archiv fur Technisches Messen (ATM)*, Germany, Section V 3621-3, Nov. 1937.

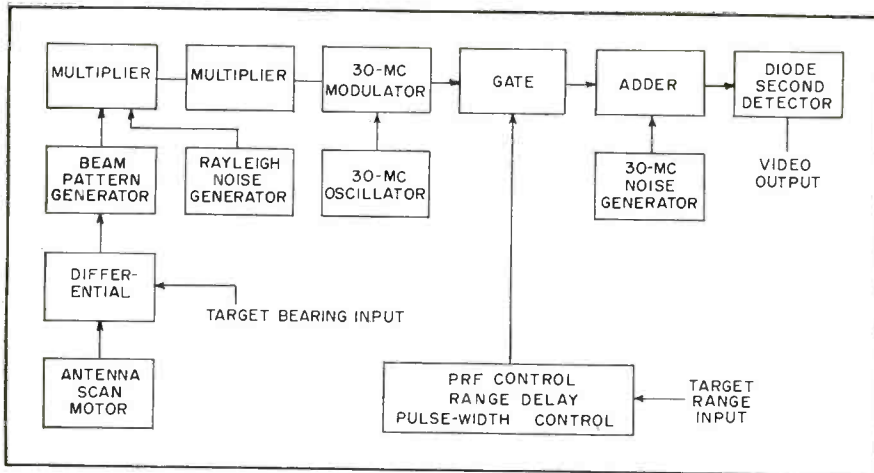

FIG. 1—Functional block diagram of complete radar video simulator

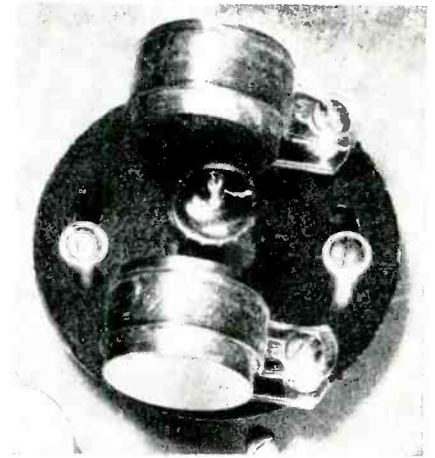

FIG. 2—Noise-generator thyatron

# Radar Simulator

**SUMMARY** — Equipment for design and testing of data-processing systems duplicates statistical and systematic characteristics of video signal from search radar receiving echoes from flying target. Among other factors, target scintillation is simulated by regulated wide-band Gaussian noise generator, antenna beam pattern is simulated by photoelectric function generator using commercial cro and receiver noise is simulated by 30-mc noise generator

**N**EEDED for an entirely realistic radar simulator arises in the design and testing of automatic detection, track-while-scan, beam-splitting and other data-processing systems. The study and training of human operators employing radar presentations for target detection, tracking, beam splitting and aircraft control also requires highly authentic radar simulation. The equipment to be described provides a simulated search radar output having the same statistical and systematic characteristics as are obtained from a real radar receiving echoes from a flying target.

The realistic simulator allows the following parameters which characterize radar targets and radar systems to be accurately controlled: target scintillation amplitude probability distribution; target scintillation spectrum; antenna beam axis

rms signal-to-noise ratio; receiver noise figure; receiver bandwidth; antenna pattern shape and beamwidth; pulse shape and pulse width; pulse repetition frequency; antenna scan rate.

Provision is made for the position of the simulated target to be controlled by the output of a conventional target-motion generator. Range of the target is determined by a d-c voltage input to the simulator and bearing is controlled by the rotation of an input shaft.

The simulator output can be fed directly to a ppi or A scope for presentation. It can also be fed to an automatic device for further processing.

## Radar Process

The operation of the realistic simulator can best be explained after a discussion of the phenomena

which constitute the radar process. There are three salient features.

The size of a radar target is large compared to a radar wavelength. For example, an aircraft may have a wing span of 100 feet while the radar wavelength may be only three centimeters so that the target is about 1,000 wavelengths long. As a consequence, the aircraft appears as a body composed of many individual reflectors rather than as a single source of reflection.

Echoes from various portions of the target surface reinforce or cancel by wave interference. The resultant echo fluctuates in a random manner as the aircraft attitude shifts because of wind buffeting and because of the skin vibration caused by the engines.

The phase of the fluctuating echo has a uniform probability distribu-



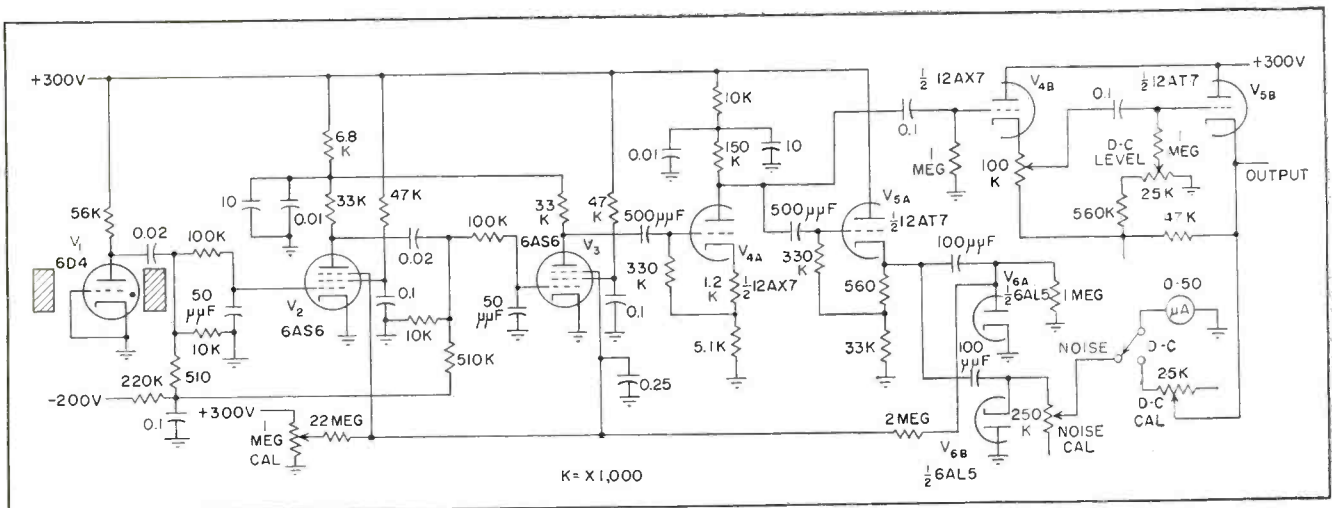

FIG. 3—Regulated wide-band Gaussian noise generator has maximum output of 10 v rms,  $\pm 1$  db from 0 to 15 kc

# for Laboratory Use

By HENRY J. BICKEL and ROBERT I. BERNSTEIN

Electrical Engineering Department  
Columbia University  
New York, New York

tion from zero to  $2\pi$  radians, while the amplitude of the fluctuating echo possesses a Rayleigh distribution. The power spectrum which characterizes the rate of fluctuation has been measured for various types of targets.

## Antenna Scanning

The antenna beam pattern modulates the echo as it scans over the target. The amplitude of the signal in the receiver is proportional to the product of the instantaneous effective target reflecting area and the instantaneous two-way gain of

the antenna in the direction of the target.

Receiver noise possesses a Gaussian amplitude probability distribution and a power spectrum which is determined by the frequency characteristic of the receiver. The receiver noise adds linearly to the signals at the front end of the receiver. Relative strengths of the signal and receiver noise can be specified accurately by stating the rms signal-to-noise ratio.

The signal and receiver noise are combined linearly before reaching the diode detector located at the

i-f amplifier output. It would not be a valid simulation of the process to add receiver noise to the video signal which is obtained at the output of the diode second detector.

A block diagram of the simulator is shown in Fig. 1.

The random fluctuations of an aircraft's radar reflectivity possess the same statistical properties as the output of a properly designed narrow-band-pass filter excited by wide-band Gaussian noise. If the filter's frequency characteristic is properly chosen the output will

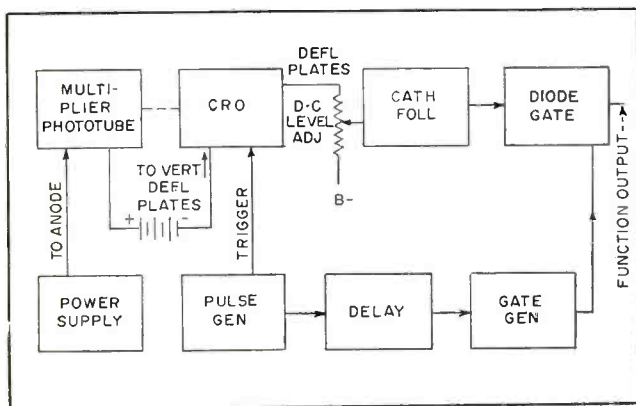

FIG. 4—Photoelectric function generator portion of simulator

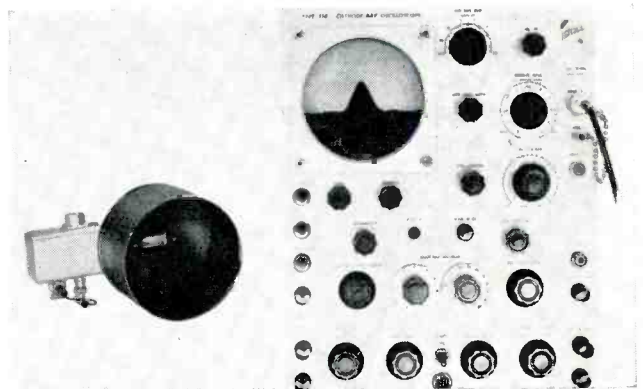

FIG. 5—Phototube housing and cro used in function generator

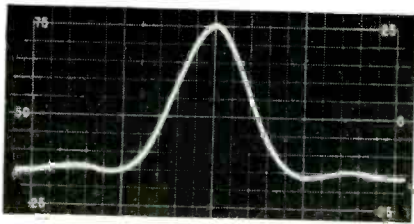

FIG. 6—Function generator output simulates antenna beam pattern

FIG. 7—Multiplier produces product of target-scintillation-envelope signal and antenna-beam-pattern signal

have an envelope which possesses the same power spectrum as the aircraft scintillation. The amplitude probability distribution of the filter output envelope will be the Rayleigh distribution.

### Scintillation Noise Generator

Wide-band Gaussian noise is generated by a 6D4 thyratron in a magnetic field as shown in Fig. 2 and 3. The magnetic field is adjusted to prevent plasma oscillations within the gas discharge which would disturb its statistical properties.

The noise voltage is fed to amplifiers  $V_2$  and  $V_3$ . Gain is automatically controlled to maintain a constant mean square output voltage because the gas discharge experiences a slow and unpredictable drift in intensity.

The signal grid to plate transconductance of the 6AS6 dual-control pentode is determined by its suppressor grid bias, which, in this case, is derived from the rectified and filtered output of the noise generator. If the noise generator output should increase, the 6AS6 suppressor voltage will become more negative and the resulting decrease in amplifier gain will tend to reestablish the desired noise level at the output.

The wide-band Gaussian noise, whose rms value is now closely regulated, is fed to a crystal filter. The filter is designed so that its output will have the same statistical characteristics as the scintillation of a given type of aircraft. The crystal's characteristic can be changed to accommodate aircraft of several types.

The noise generator has been designed for a maximum output of 10 volts rms. Its frequency spec-

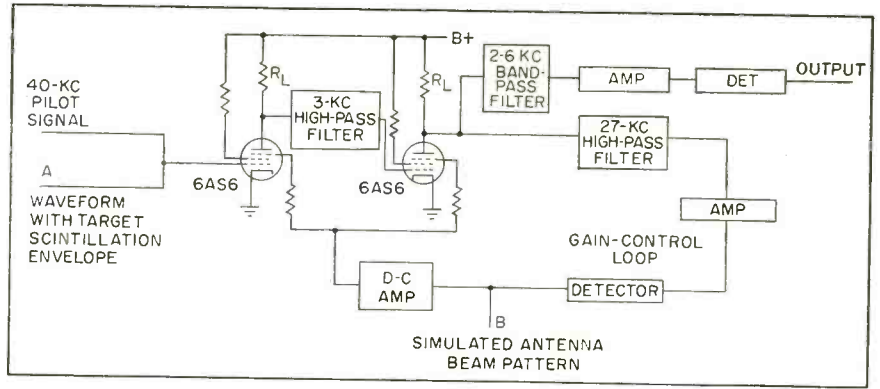

trum is flat to within one db between one and 15 kc.

The antenna scan motor can be adjusted to turn at the same speed as the antenna of the radar under simulation. Angular motion of the target is introduced as one input to a differential gear, while the antenna rotation obtained from the motor is the other input. The differential output then is the same as the antenna rotation relative to the target's motion.

Once every scan the beam axis of the antenna coincides with the target bearing. Slightly before that point is reached, the antenna beam pattern generator is triggered by a thyratron pulse generator.

### Beam Pattern Generator

The antenna beam pattern is produced by a photoelectric function generator (Fig. 4) that has a standard wide-band oscilloscope as its major constituent.

As shown in Fig. 5, a template

cut to the shape of the two-way antenna pattern is mounted over the face of the crt and a multiplier phototube is placed in front of it. When there is no output from the phototube, the crt beam is deflected upward; when the photocell produces an output, the cathode ray is deflected downward. The equilibrium condition is for the beam to follow the edge of the template.

As the horizontal sweep drives the beam across the screen a voltage corresponding to the shape of the template is produced at the vertical deflection plate, as shown in Fig. 6. Each time the output shaft of the differential gear reaches the triggering point the horizontal sweep of the function generated begins. It is necessary to adjust the horizontal sweep rate to correspond to the desired antenna beam width and antenna scan rate.

The voltage which appears at the vertical deflection plates of the crt

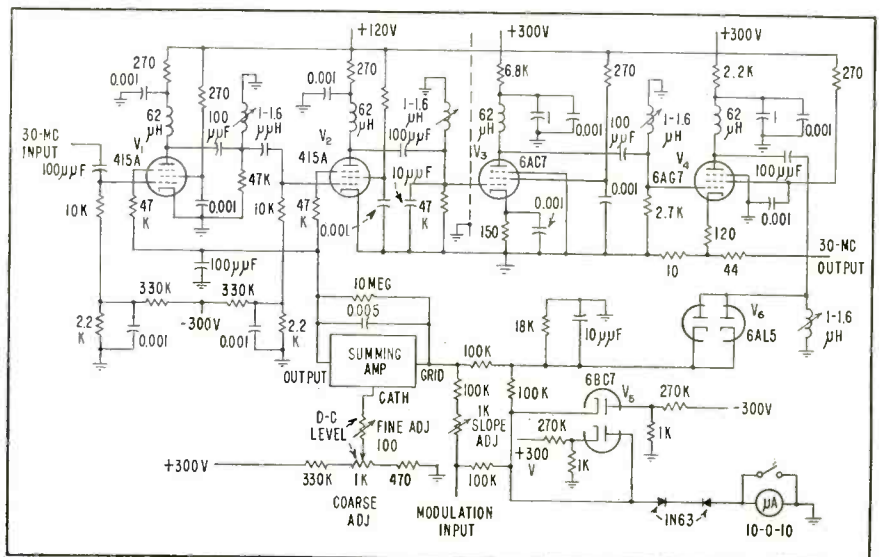

FIG. 8—Thirty-mc modulator imposes product voltage from multiplier on i-f carrier

contains undesirable discontinuities in addition to the desired waveforms. A linear bidirectional diode gate<sup>1</sup> is employed to select the useful function output.

The switching waveform, which is fed to the diode gate, is generated by a monostable cathode-coupled multivibrator. The delay unit consists of a phantastron.

To assure proper performance of the function generator the intensity and focus of the electron beam must be held constant as a function of time and spot position. A change in the spot intensity or its size is equivalent to a change in the loop gain of the function generator.

### Multiplier

The multiplier, shown in Fig. 7, is of the pilot-signal type. It consists of a variable-gain amplifier whose gain is controlled by one of the signals to be multiplied, signal *A*, and into which is fed the other signal, *B*. The output is proportional to the product of the two.

To obtain good control of the gain, a constant amplitude pilot signal at 40 kc is added to signal *B*. A filter at the output of the variable gain amplifier passes only the pilot signal and its adjacent sidebands to a detector which recovers the sidebands.

The output of the detector is fed to a voltage comparator where it is compared to signal *A*. The difference is amplified and fed to the gain-control grids of the variable gain amplifier. This feedback arrangement insures that the amplifier gain will follow signal *A* closely. Signal *B* is fed to the signal input of the amplifier. The final output follows the product of *A* and *B* with an accuracy of 2 percent over a dynamic range of 44 db.

To improve the dynamic range of the multiplier, the gain control characteristic of two 6AS6 tubes was used. In the absence of the gain-control feedback loop, the use of these tubes for modulation would result in multiplying *A* by the square of *B*. The feedback loop suppresses this undesirable modulation of *A*.

The product voltage obtained from the multiplier must be imposed as amplitude modulation on

an i-f carrier. This is done by the 30-mc modulator, which operates on the same principle as the multiplier.

A variable gain 30-mc amplifier has its gain controlled by the output of the multiplier. The output is the same as the signal that would occur in a radar i-f amplifier except that it is not gated and receiver noise is absent.

The schematic diagram of the modulator is shown in Fig. 8. Because of their lower control grid to plate capacitance, 415-A tubes were employed instead of 6AS6.

The 30-mc input is amplified by four synchronously tuned stages. In the first two amplifier stages gain is a function of suppressor bias. The amplified 30-mc signal is detected and compared to the modulation input to obtain an error signal. The error is amplified and applied to the suppressors of the variable-gain amplifier stages.

A microammeter indicates any appreciable difference between the magnitudes of the modulation input and the detected 30-mc envelope. The useful 30-mc output is obtained from a tap in the cathode of  $V_1$ .

When the suppressor bias of  $V_1$  and  $V_2$  is -1 volt and the detector output is 100 volts d-c the low-frequency gain of the feedback loop is approximately 76 db. As the detector output is decreased, the loop gain changes proportionally such that at an output of 10 volts d-c the loop gain of the system has decreased to 56 db.

The plot of detector output voltage versus modulation input voltage, in Fig. 9, shows linearity of better than one percent of full scale for inputs ranging from 0.1 to 120 volts d-c.

Total harmonic envelope distortion for approximately 100-percent modulation at a 60-cps modulation frequency was determined with a Barker and Williamson distortion meter. With a modulating voltage amplitude of 20 volts peak-to-peak, 5-percent envelope distortion was found. A similar measurement at 600 cps indicated 10-percent distortion.

### Range Gate

The range gate is a pentode whose transconductance is controlled by the signal on its sup-

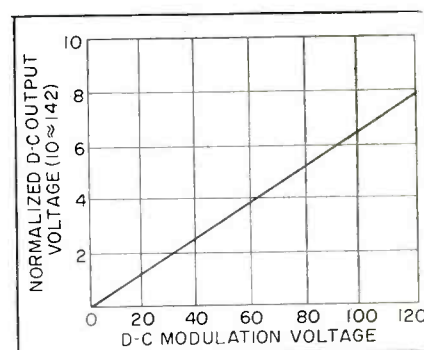

FIG. 9—Thirty-mc detector characteristic for high voltage level

pressor grid. In the absence of a pulse on the suppressor the tube is cut off.

The gate is controlled by several pulse circuits. A free-running adjustable multivibrator determines the prf. A phantastron triggered by the multivibrator determines the range delay.

The delay of this phantastron is controlled by a d-c voltage which is fed to the simulator, thus furnishing a means of controlling target range. Pulse width is determined by an adjustable monostable multivibrator triggered by the phantastron.

### Thirty-Mc Circuitry

It is necessary to add 30-mc receiver noise to the grated output of the modulator to reproduce fully the voltages that occur in the i-f amplifier of a real radar. The signal pulse from the gate is combined with noise in the adder.

The 30-mc noise generator is a high-gain amplifier whose bandwidth is matched to the desired pulse width. The natural noise at the front end is amplified by about 120 db.

The arrangement is such that noise is always present at the output of the adder, while the signal is present only during the pulse duration. This duplicates the situation in a radar, since receiver noise is always present, while the signal occurs with a small duty cycle.

The diode second-detector and post-detector circuits are the same as those of a radar set.

### REFERENCES

- (1) J. Millman and T. H. Puckett, Accurate Linear Bidirectional Diode Gates, *Proc IRE*, 43, p 27, Jan. 1955.

# Transistors and Diodes

**SUMMARY** — Two-channel transistor amplifier uses feedback developed by silicon junction diode of zener reference type. Diode forward resistance is varied as a function of input signal amplitude to control amplifier gain. Overall servo sensitivity can be held constant within  $\pm 25$  percent over a control-voltage range of 100 to 1 and temperature range of  $-55$  C to  $+85$  C

**S**ERVOS employed in a-c analog computers are variable gain types, where the servo-loop gain is a function of one of the inputs. Depending on the desired accuracy, servo gain must be held within specified limits, for example,  $\pm 20$  percent. In practice, variable-gain servos may have gain variations of 50 to 1, making it apparent that some form of gain equalization must be used.

A transistorized age circuit to

By **R. GITTLEMAN**

*W. L. Maxson Corp.  
New York, N. Y.*

be described uses a shunt-feedback amplifier with a nonlinear element in the feedback loop to control gain. The small signal resistance of the nonlinear element is made to vary inversely with control voltage.

With the feedback amplifier inserted in the servo error-voltage

path, overall sensitivity of the servo can be held constant within  $\pm 25$  percent over a range of control voltage variations of 100 to 1. This control can be maintained over an ambient temperature range of  $-55$  C to  $+85$  C.

### Control Element

The nonlinear control element is a silicon junction diode. The small signal resistance of the diode may be varied over a wide range by biasing with d-c in the forward direction.

Biasing allows the diode resistance to be controlled by a linear variable, hence its resistance can be accurately controlled by a voltage in series with a resistance that is high compared to the highest value of diode resistance of interest.

For a typical silicon junction diode the forward resistance is about 30,000 ohms for a forward bias of one microampere and about 30 ohms for a bias of one milliampere.

Saturation current is temperature-dependent and approximately doubles in value for an 11 C rise in

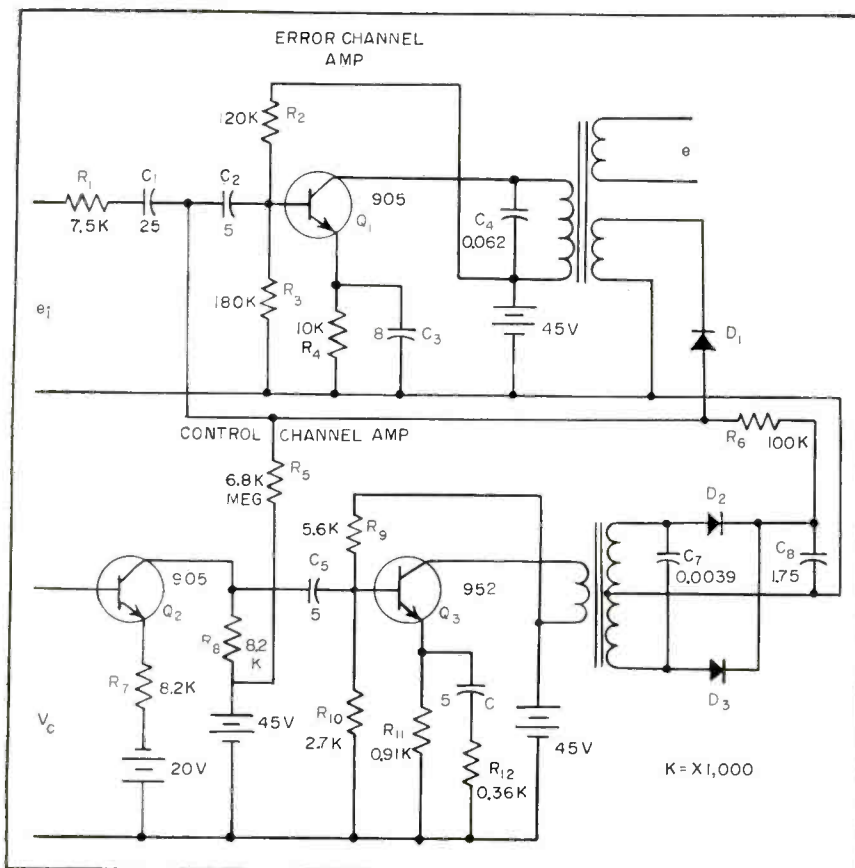

FIG. 1—Complete age servo amplifier circuit



Servo amplifier with age is compact

# Stabilize A-C Servos

diode junction temperature. At room temperature, it is usually less than 0.1 microampere and can be ignored. At higher temperatures, the increased saturation current will limit the lower bias current range of operation of the diode.

Another factor that limits the range of operation of the diode is a constant ohmic resistance due to imperfections introduced during manufacture. This resistance limits use of the diode at high bias currents.

It is not uncommon to obtain a forward-current range in excess of 1,000 to 1 in junction diodes and those with high forward conductance and low saturation currents are generally used. Zener reference diodes are excellent for this application.

## Circuit Description

The complete acg circuit is shown in Fig. 1. This particular circuit was designed to be used in the resolver servo illustrated in Fig. 2. The servo error-voltage applied to the acg amplifier is  $e_1$ . The output voltage  $e_2$  drives a servo amplifier. The quadrature voltage winding of the resolver  $V_c$  is used to obtain the acg control voltage.

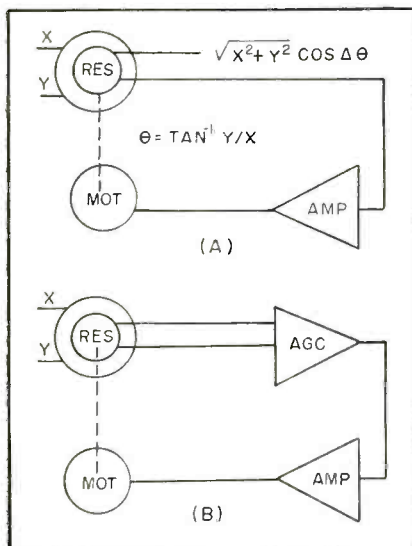

FIG. 2—Basic resolver servo system without acg (A) and with acg (B)

The circuit is divided into two channels. The feedback amplifier, designated the error-voltage channel, is inserted in the servo forward transmission path. The second channel, designated the control-voltage channel, converts the sensitivity voltage of the resolver into d-c for biasing the control diode.

## Error-Voltage Channel

The error-channel amplifier is a one-stage shunt-feedback amplifier using an output transformer for isolation and for providing the proper amount of feedback. Control diode  $D_1$  is d-c isolated from the error-voltage amplifier by the two input capacitors  $C_1$  and  $C_2$ . The direct current bias for the diode is provided by resistance  $R_6$ . Input impedance to the error-voltage channel need not be high since no coupling exists between the resolver air gap flux and the rotor winding at servo null.

The a-c voltage applied to the diode is limited to about 30 mv. Above this level the diode begins to rectify and the output voltage is greatly distorted. Only one-thirteenth of the output voltage is used for feedback. The maximum undistorted output in this case is approximately 0.4 v.

## Control Voltage Channel

The first stage of the control-channel amplifier provides a high-impedance input for the quadrature winding of the resolver. This is obtained by inserting resistance  $R_7$  in the emitter of  $Q_2$ .

The second stage converts the a-c control voltage to d-c through a full-wave rectifier and resistance  $R_8$ . At low control voltages, rectifiers  $D_2$  and  $D_3$  have high forward resistance and poor rectification properties. Because of this, the forward bias current delivered to the control diode  $D_1$  is low. Resistor  $R_9$  biases control diode  $D_1$  to linearize the circuit at low control voltages.

Resistor  $R_{12}$  degenerates the gain

of  $Q_3$  and serves as a convenient gain trimmer for the entire circuit.

## Experimental Data

Experimental data for the circuit is plotted in Fig. 3 for ambient temperatures of  $-55$  C,  $25$  C and  $85$  C. The gain does not vary for control voltages less than 0.1 v or greater than 15 v. For control voltages less

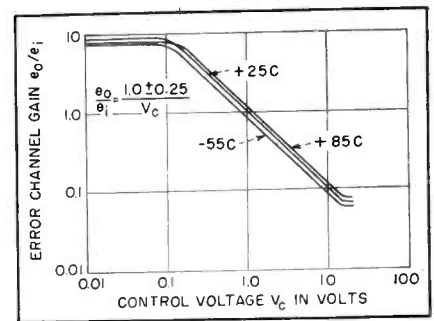

FIG. 3—Transfer characteristics of acg amplifier over temperature range of  $-55$  C to  $+85$  C

than 0.1 v, diodes  $D_2$  and  $D_3$  do not receive sufficient voltage to act as rectifiers. For control voltages greater than 15 v, the second stage saturates and the forward bias current through diode  $D_1$  is limited.

The transfer function of the circuit increases from  $1.0/V_c$  at  $25$  C to  $1.12/V_c$  at  $85$  C. The increase in the small-signal resistance of control diode  $D_1$  should result in an increase in the transfer function to approximately  $1.2/V_c$  at  $85$  C, but an increase in gain of the control-voltage channel tends to compensate for this. The increase in gain of the control channel is caused by an increase in current gain of transistor  $Q_3$ . Similarly, at  $-55$  C the decrease in the transfer function of the circuit to  $0.9/V_c$  is not severe because of the reduction of current gain of transistor  $Q_3$ . The degenerative feedback introduced by resistor  $R_{12}$  tends to minimize changes in the gain of  $Q_3$ .

## BIBLIOGRAPHY

W. Shockley, The Theory of  $p-n$  Junctions in Semi-conductors and  $p-n$  Junction Transistors. *BSTJ*, 28, p 435, July 1949.

# TANTALUM Capacitors

DAVID A. McLEAN

Bell Telephone Laboratories  
Murray Hill, N. J.

**SUMMARY** — Aqueous electrolytes found in standard electrolytic capacitors are replaced by solid semiconductor material which provides capacitance values from 5 to 100 microfarads at a working voltage of 8 volts when used with tantalum and tantalum-oxide anodes. Units can be used at up to 35 volts by dividing capacitance value by five. Power factors of 2 percent have been obtained up to 200 kc and leakage current compares favorably with standard units. Capacitors have immediate application in transistor circuits

**C**ONVENTIONAL ELECTROLYTIC capacitors have many limitations imposed by the aqueous electrolytes which they contain. At elevated temperatures electrolytes dry out unless the capacitors are effectively sealed. At low temperatures electrolytes congeal or actually freeze introducing series capacitance and series resistance. Limitations at high frequency also result from the electrolytes.

In the new tantalum solid-electrolyte capacitor the aqueous electrolyte is replaced by a solid semi-conductor. Thus this capacitor consists entirely of stable, non-volatile inorganic materials.

## Tantalum

The anode is tantalum metal which may be had in a variety of

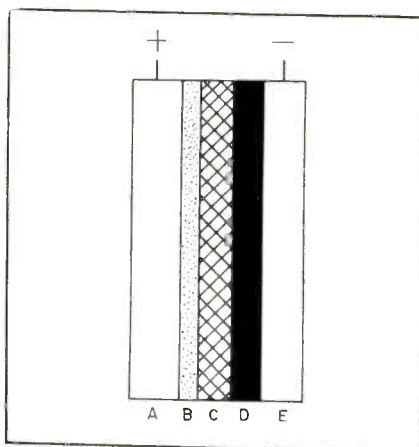

FIG. 1—Structure of solid-electrolyte capacitor

forms such as sintered porous bodies, wire or foil. Most of the development to date has been di-

rected at capacitors with porous tantalum anodes, because they give the highest capacitance-to-volume ratio.

A thin layer of tantalum oxide,  $Ta_2O_5$ , is formed on the tantalum surface by making the tantalum piece positive with respect to a cathodic member in a suitable electrolytic bath. The thickness of oxide film is proportional to the formation voltage.

Capacitance is proportional to the tantalum surface area, and inversely proportional to the oxide thickness. The working voltage is approximately proportional to the oxide thickness.

An intimate layer of the semiconductor  $MnO_2$  is deposited over the surface of the  $Ta_2O_5$ . This  $MnO_2$

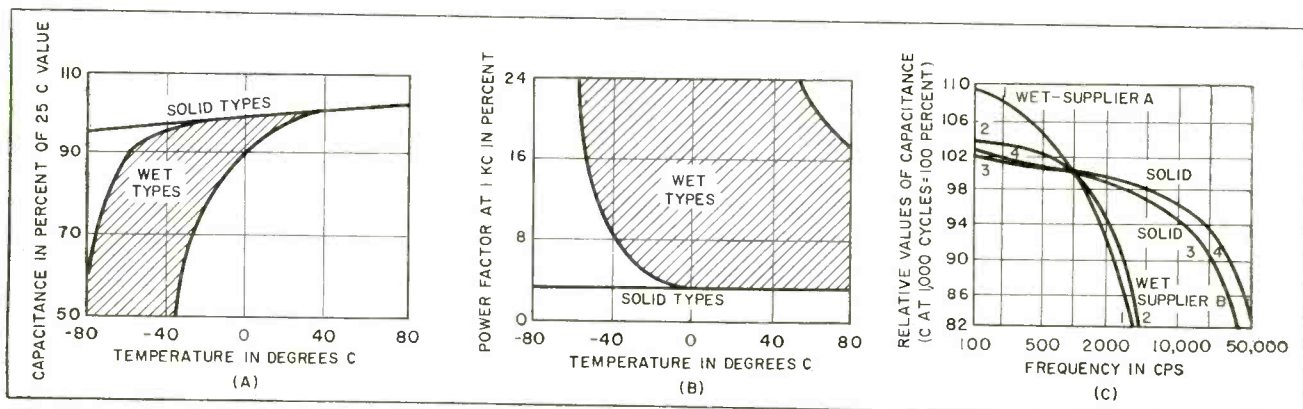

FIG. 2—Typical characteristic curves for solid electrolyte capacitors are: capacitance-temperature (A), power factor-temperature (B) and capacitance-frequency (C)

# Use Solid Electrolyte

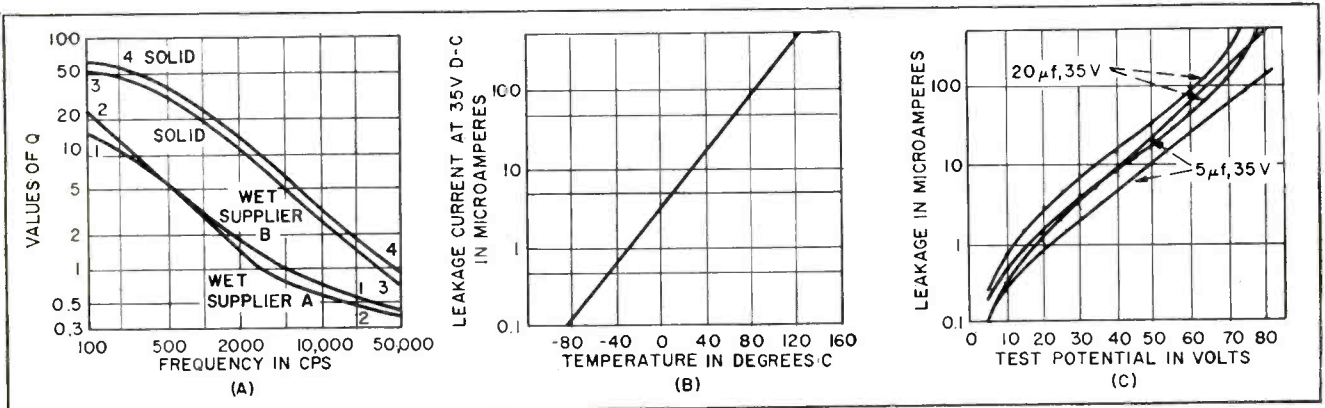
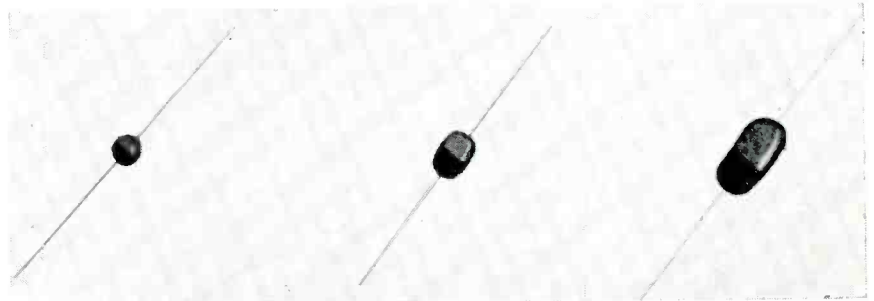

FIG. 3—Curves show Q-frequency (A), leakage current-temperature (B) and leakage current-voltage (C) characteristics of solid-electrolyte capacitors



Typical porous-tantalum solid-electrolyte capacitors range from 1/4 to 1/2 inch in length

layer is formed by decomposing manganous nitrate introduced in aqueous solution. A carbon layer is added by applying an aqueous dispersion and allowing the water to evaporate.

The carbon produces intimate electrical contact with the  $MnO_2$  and constitutes a mechanical buffer between the inner structure and the cathode which relieves strains and allows for differential thermal expansion.

## Structure

The structure of the tantalum solid-electrolyte capacitor is represented schematically in Fig. 1. The capacitance values for a working potential of 8 volts are 5, 25, and 100 microfarads. For a working voltage of 35 volts, these values are divided by five.

Like other electrolytics, these capacitors are polar. At present, the porous type is being restricted to an upper operating potential of about 35 volts.

Voltage rating practice has been to establish ratings for the tem-

perature range up to 65 C, with voltage derating for higher temperatures.

## Characteristics

Capacitance-temperature characteristics of various solid-electrolyte capacitors are shown in Fig. 2A for a frequency of 1 kc. It is believed that the capacitance change with temperature represents the temperature dependence of the dielectric constant of  $Ta_2O_5$ . Only at the higher temperatures is this true for the wet types. Low temperature behavior is controlled by the electrolytes which interpose series capacitance as their resistivity increases.

Power factor values against temperature are shown in Fig. 2B.

From Fig. 2B and other measurements it appears that the losses in solid electrolytics consist primarily of dielectric loss in the tantalum oxide.

Power factors in the range of 2 percent have been obtained up to 200 kc.

In frequency characteristics, the

solid type appears to be limited by the  $MnO_2$  and carbon layers. However, at equal capacitance and voltage ratings, the solid type characteristics hold to about a decade higher frequency when compared with wet types at equivalent capacitance and voltage ratings. This is illustrated in Fig. 2C and Fig. 3A.

## Leakage

Figure 3B shows a typical leakage current-temperature curve for solid electrolyte capacitors while Fig. 3C shows leakage current-voltage curves.

The leakage current values observed for the solid type are much more dependable and stable than those for the wet types. In particular, the values do not deteriorate with shelf aging even at elevated temperatures and no forming period is required after disuse.

Leakage currents are stable on long continued application of voltage if the voltage and temperature are moderate. Leakage currents do increase progressively if voltage and temperature are too high.

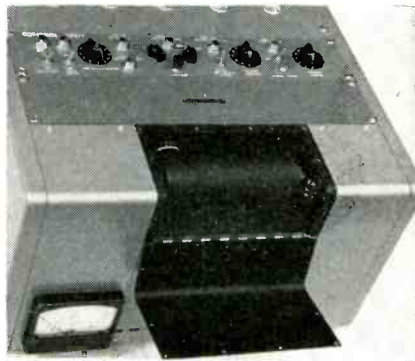
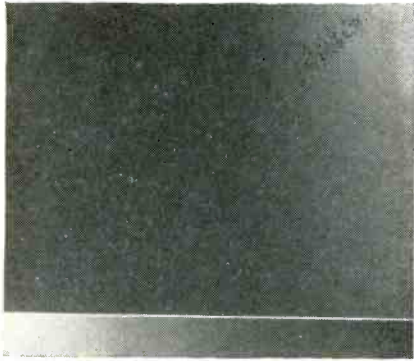

Sample film plate in which density corresponds to z dimension is shown at extreme left. Gray-scale standard is evident along the bottom of the plate

Instrument for preparing photographic film plates for use with the Phosiac. Film drum is shown with light source behind it

# Photoelectric Analog

By **ROBERT A. SINKER**

Director of Research and Development  
Stephen-Douglas Company  
Santa Monica, California

**T**HREE-DIMENSIONAL data which has previously been stored as density variations in photographic film can be read out by the *Phosiac*, Photographically Stored Information Analog Comparator. The unit is part of a system which reduces data from curves to film-density storage.

Data read out involves measuring the light intensity allowed to pass through a film plate at any given  $x-y$  coordinate. A cathode-ray tube is used as the light source and the means for positioning the spot. A multiplier phototube measures the light intensity.

Photographic data storage of this type has frequently been unsatisfactory because of variations in photographic, lighting and optical conditions. The instrument to be described achieves satisfactory accuracy for function-generator use by incorporating a gray-scale standard deflection feedback loop and an intensity servo feedback loop both used with a second beam of light in a nulling correction arrangement.

The instrument provides three-dimensional function generation with response speed high relative to two-dimensional servo-driven potentiometers. Equations may be changed merely by exchanging film plates. A sample data-storage film plate is shown in a photograph. The

gray scale may be seen at the bottom of the plate.

Current specifications call for an accuracy of 2 percent and a frequency response of 100 cps. Development is underway to extend the system capabilities to 1-percent accuracy and 2,000-cps response.

## Deflection Feedback

Figure 1 illustrates the basic operation of the instrument. Two spots are generated on the screen of a two-gun crt. The intensities of the spots are modulated at 5 kc, 180 deg out of phase with each other.

The combined intensity of the two spots is constant when the gray-scale deflection beam is deflected to read equal film intensity. The screen of the crt is imaged on the information plate by the primary lens causing one spot to focus on the information area and the other on the gray scale. The light transmitted by both areas of the information plate is refocused on the cathode of a multiplier phototube.

The output of the phototube is thus a 5-kc suppressed-carrier signal indicating the relative light transmission of the interrogated points

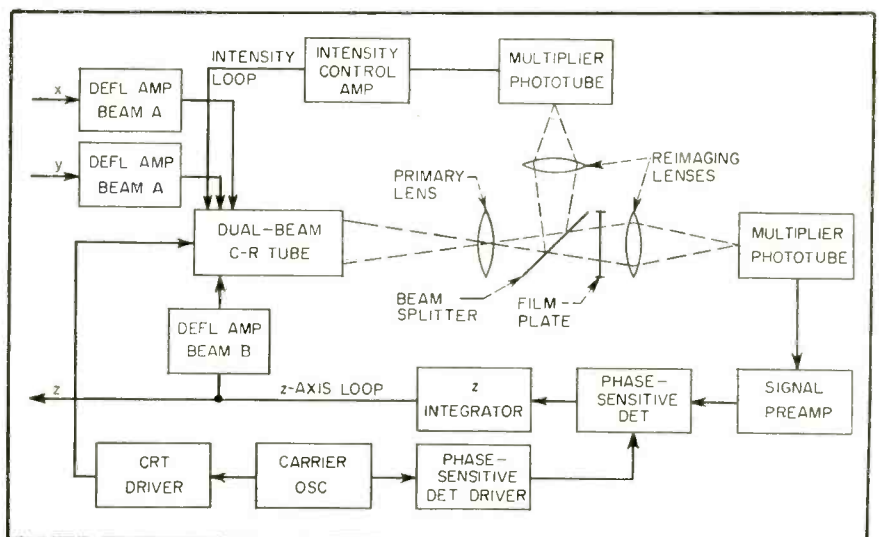

FIG. 1—Function generator includes intensity-control servo loop and nulling arrangement that compares density information with gray-scale standard



**SUMMARY** — Nonlinear functions of three variables can be fed into analog computers by making one variable correspond to density variations in a photographic film plate and using an instrument resembling a flying-spot scanner to read it out electrically. Accuracy is insured by a gray-scale-standard feedback loop and a servo loop that keeps light intensity within tolerance. Transistors work side by side with electron tubes deriving their collector potential from a simple voltage divider across the power supply

# FUNCTION GENERATOR

in the information area and on the gray scale. A preamplifier, phase-sensitive detector and output amplifier convert this signal to a d-c voltage.

The d-c voltage is fed to a deflection amplifier which positions the gray-scale spot to null the 5-kc output from the phototube. At null the signal from the output amplifier controlling the position of the gray-scale spot indicates the transmission of both points on the data plate. This is the dependent variable  $z$ .

## Intensity Feedback

To compensate for variations in phosphor efficiency over the face of the crt and for differences between on-axis and off-axis transmission by the lenses, a second light path is provided by a beam-splitting mirror, reimaging lens and multiplier phototube. The second light path is identical to the first except for the omission of the data-storage plate in the second light path.

The output of the second phototube is held constant by an intensity servo, insuring that the first phototube senses only differences in light transmission caused by the data plate.

Two deflection amplifiers control the position of one spot in response to the  $x$  and  $y$  inputs to the instrument to interrogate the desired

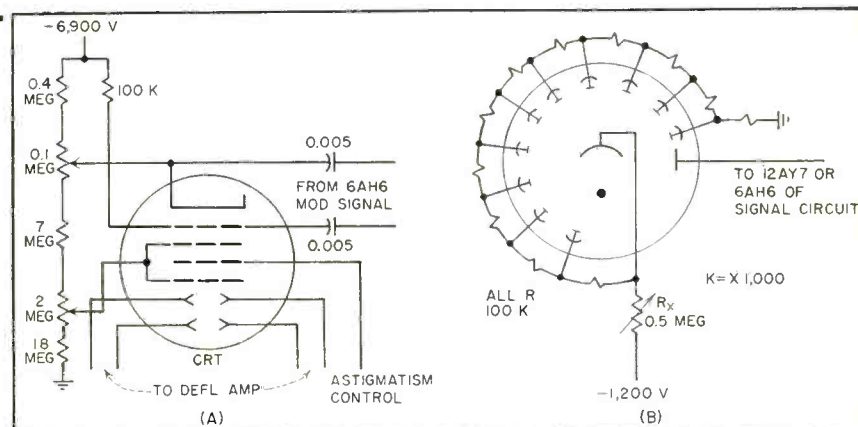

FIG. 2—High-voltage supplies for cathode-ray tube, one circuit for each gun, (A) and for multiplier phototube (B)

area of the data storage plate.

All optical axes lie in a single plane. The primary lens focuses the screen of the crt on the information plate. A 2-to-1 optical reduction matches the 3-in. square area on the face of the crt to the 1.5-in. square area of the information plate. The secondary lens images the aperture of the primary lens on the cathode of the phototube.

Since useful light from any point on the screen of the crt must pass through the aperture of the primary lens, the secondary lens causes all light to be focused on a fixed area of the phototube cathode irrespective of the crt spot positions. This eliminates susceptibility to variations in electron-emission efficiency over the photocathode surface. The beam-splitting mirror directs a constant fraction of the light to a second reimaging lens and phototube.

The primary requirement of the optical system is symmetry between the two light paths exclusive of the data plate, so that when a null is reached on one phototube a null will exist on the other phototube, subject only to a balanced transmission through the data plate. The primary lens is common to both optical paths and thus contributes no asymmetry. Uniformity and symmetry between the two secondary lenses is achieved by careful design and manufacture. Nonuniformity of reflection and transmission of light caused by different angles to the beam splitter is controlled by means of a variable reflective coating.

## Multiplier Phototube

A schematic of the crt and phototube high-voltage circuits is shown in Fig. 2. The crt has two guns which are completely independent except for a common accelerating

anode. Since deflection linearity is of prime importance to accuracy, no post-deflection accelerator is employed.

Since the deflection amplifiers must be directly coupled to the deflection plates of the crt, the acceleration and deflection plates are operated at +600 v d-c. To obtain good spot resolution and intensity, 7,500 v d-c accelerating potential is realized by operating the cathodes of the tube at -6,900 v.

The intensity modulating signals are 5 k-c sine waves capacitively coupled to the grids of the two electron guns. An astigmatism control and dual focus and intensity controls set the static operating levels.

The phototube high-voltage circuit is a uniform voltage divider providing equal accelerating voltage to each dynode. Series resistor  $R_x$  adjusts the voltage to compensate for the variations in sensitivity among phototubes. The tuned cir-

cuit forming the anode load for the phototube is located on the signal-amplifier chassis.

### Deflection Amplifiers

The deflection amplifier subassembly schematic is shown in Fig. 3. The circuit contains three identical deflection amplifiers, a control for positioning one spot on the gray scale and the astigmatism control. The high accelerating potential of the crt and lack of post-deflection accelerators require a deflection amplifier output of  $\pm 400$  v.

Minimization of spot size requires balanced output, and end accuracy dictates extreme linearity. These requirements are met in a circuit combining the balance characteristics of the grounded-grid phase inverter with the gain and linearity stability of the feedback computing amplifier.

To obtain the required voltage output, it was necessary to use a

supply voltage in excess of the capabilities of receiving-type voltage-amplifier pentodes. The type 6842 is designed to operate with anode potentials in the kilovolt region and meets the output voltage requirements for the deflection amplifier. The circuit is similar to the grounded-grid phase inverter, often used in computer circuits.

Since the drive to the crt deflection plates is a push-pull signal with only one output contained in the feedback loop, it is necessary to maintain precise balance between the two outputs. This is accomplished by using a large common cathode resistor returned to -300 v. The large cathode resistor closely regulates the total current drawn by the two tubes and therefore the mean output voltage.

This eliminates any variations in astigmatism due to deflection amplifier tube characteristics. The signal level at the input to the deflection amplifier, which is the scale for both the input and output signals is  $\pm 50$  v. The required gain of approximately 8 is controlled by the ratio of the feedback resistor  $R_1$  to input resistors  $R_2$  and  $R_3$ .

The gain of the pentode circuit is approximately 1,000 so that the gain with the feedback network is primarily dependent upon the resistance ratios as in computing amplifiers. Since the output voltage is not the same as the input, it is necessary to supply a compensating bias. This is supplied by  $R_4$  and  $R_5$ .

Variable resistor  $R_4$  allows for variations in components including tube unbalance. Variable resistor  $R_5$  matches the fixed input range of  $\pm 50$  v to the variations in deflection sensitivity of crt's.

Resistor  $R_6$  balances the load in the deflection amplifier and insures a balanced output voltage. Since the deflection sensitivity and spot position for zero deflection vary among crt's, the gain and balance controls for the deflection amplifier are set after the complete unit is assembled. Manual positioning control  $R_7$ ,  $R_8$  and  $R_9$  provides a balanced deflection voltage to position one spot at the center of the gray scale. This control compensates for variations in the position of the undeflected beam in crt's. Astigmatism control  $R_{10}$ ,  $R_{11}$  and  $R_{12}$ , ad-

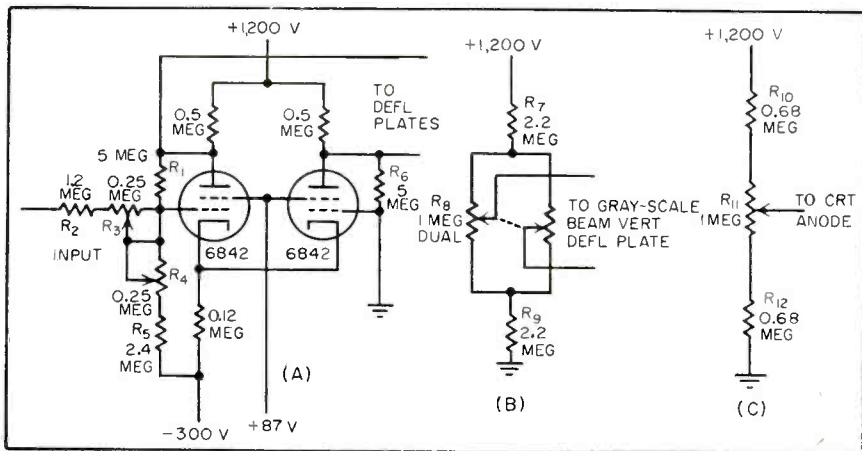

FIG. 3—One of three identical deflection amplifiers (A), the control used to center one crt beam in the gray-scale band (B) and the astigmatism control (C)

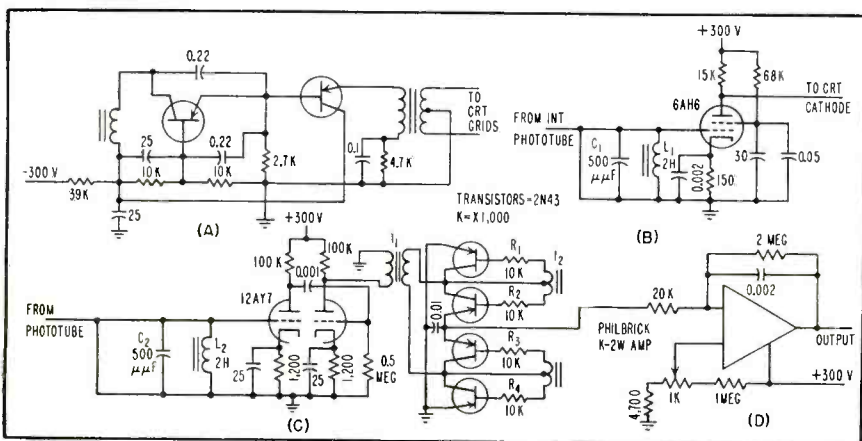

FIG. 4—Signal amplifier chassis includes: transistor carrier oscillator and emitter follower (A), amplifier for intensity phototube (B), signal amplifier and transistorized phase-sensitive detector (C) and modified feedback computing amplifier (D)

justs the anode voltage of the crt to the mean deflecting voltage.

The signal amplifier subassembly is shown in Fig. 4. It comprises a carrier-frequency oscillator and amplifier, an intensity control circuit to equalize the intensity of the two spots on the screen of the crt and the gray-scale servo to control the position of one spot along the gray scale of the data plate.

The carrier frequency is generated by a transistor oscillator utilizing a circuit similar to the Colpitts oscillator. The oscillator operates at a supply voltage of  $-22$  v obtained by a divider from the  $-300$ -v power supply and delivers a carrier output of 2 v peak to peak at the emitter. The oscillator drives a second transistor connected as an emitter follower to isolate the oscillator from the rest of the circuit.

The emitter follower drives transformer  $T_2$ , one secondary of which provides the balanced drive signal to the grids of the two guns in the crt while the other secondary windings are used in the phase-sensitive detector.

The output of the intensity phototube, which monitors the light beams not passing through the data plate, is developed across tuned circuit  $C_1$  and  $L_1$ . Any signal developed across this tuned circuit indicates an unbalance between the intensity of the two light sources.

This signal is amplified by the 6AH6 intensity-control amplifier whose output is coupled to the cathodes of the crt. The phase relations are such that the signal applied to the cathodes is of the proper polarity to equalize the carrier-frequency component of the two light sources.

Since the intensity control compensates for all optical variations except the data plate, the gray-scale servo achieves a null at carrier frequency at the output of the phototube which measures the light transmitted through the data plate. The output of the gray scale phototube is developed across tuned circuit  $C_2$  and  $L_2$ . A carrier-frequency signal at this point indicates, by its magnitude and phase, the direction and distance which one spot must be translated along the gray scale to the point of balance. This signal

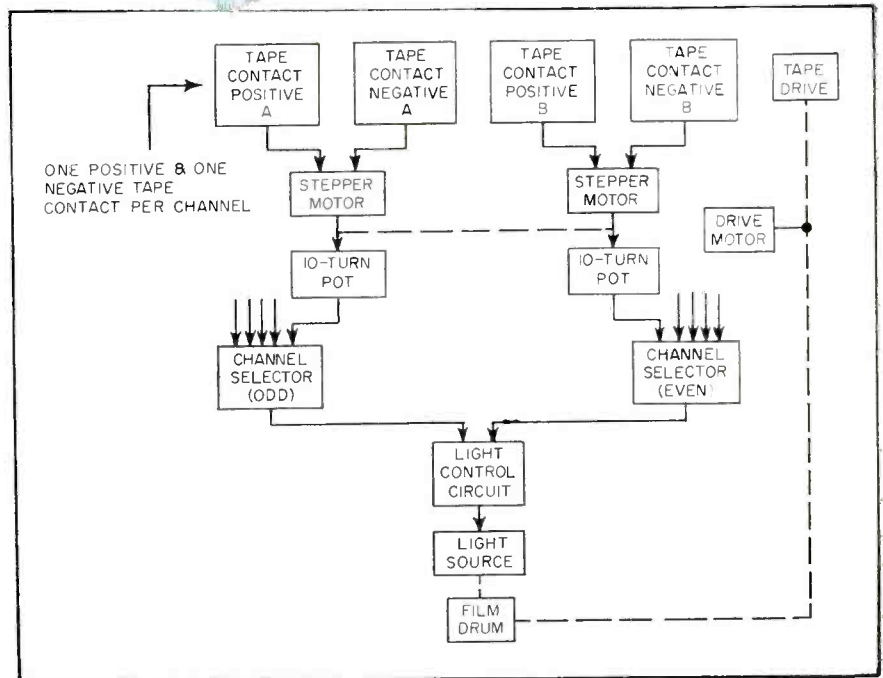

FIG. 5—Block diagram of instrument used to transfer quantized function of three variables from punched tape to light variations that are recorded on photographic film

is amplified by two sections of a 12AY7 operated as resistance-coupled amplifiers and applied to the phase-sensitive detector through transformer  $T_1$  which provides d-c isolation and proper impedance match. The phase-sensitive detector consists of four transistors in a bridge-rectifier circuit. Reference voltage is applied to the bridge by two secondaries of  $T_2$ .

This reference voltage applied between base and collector causes the transistors to function as switches at carrier frequency. Features of the demodulator circuit are its linearity of signal in the millivolt region and its ability to provide low null shift without matching components.

Using 5-percent resistors for  $R_1$ ,  $R_2$ ,  $R_3$ , and  $R_4$  and unselected 2N43 transistors, a null output of less than 10 mv is consistently achieved. This null output is stable to within 1 mv under laboratory operation. A null output of less than 1 mv has been realized with selected transistors.

The output of the phase-sensitive detector is amplified to the  $\pm 50$ -v range by a Philbrick K-2W amplifier. The output of the d-c amplifier is fed to the input of the deflection amplifier which positions one spot along the gray scale of the data plate. This signal is also fed to the

output terminal of the instrument where it indicates variable  $z$ .

### Preparing Data

The original data may be a family of curves with the abscissa and ordinate representing two of the dimensions and the parameter identifying the members of the family being the third dimension. This data is reduced to digital form and is recorded on a tape from which the photograph plate may be prepared.

One axis of each curve is arbitrarily divided into 300 units of linear dimension and the other into 300 units to be converted into photographic density.

Individual members of the family of curves are converted into a linear dimension on the photographic plate. Interpolation in the photographic exposure process converts the digital data to analog form.

### Exposing the Plate

Figure 5 shows the unit used to transfer the information from the tape to the photographic plate and to convert it from digital to three-dimensional analog form.

This development was sponsored by the U. S. Air Force, Air Research and Development Command through a contract awarded by Wright Air Development Center.

**SUMMARY** — System provides voice transmission over 3-kc bandwidth with high degree of stability over wide temperature and humidity range. Up to sixty telephone sets may be coupled to only one pair of wires by stacking six ten-telephone channels. Using 1,000-cps reference, system response is not more than 3 db down between 250 and 3,000 cps

By **JAMES E. MACDOWELL** and **H. J. B. NEVITT**

*J. E. MacDowell Associates  
Galion, Ohio*

*The Ericsson Corp.  
New York, N. Y.*

# CARRIER TELEPHONE

**E**XTENSION OF RURAL telephone services is one of the major problems now confronting the telephone industry in North America.

Rural subscribers are often scattered over wide areas, so that telephone service can usually be provided only by constructing long wire-line connections to a switchboard located in a neighboring town. Thus first cost and annual

maintenance charges per subscriber tend to be much higher in rural than in urban areas.

## Design Considerations

It is normal in rural telephony to operate, on a party line basis, up to ten subscribers with individual telephone numbers connected to one pair of wires. To provide party line service with separate metallic

circuits for sixty subscribers along one route would require six wire-like pairs.

By correct application of present carrier techniques the same result may be achieved by superimposing five carrier telephone channels on one pair of wires.

Voice transmission should have a bandwidth of approximately 3 kc with overall system response not

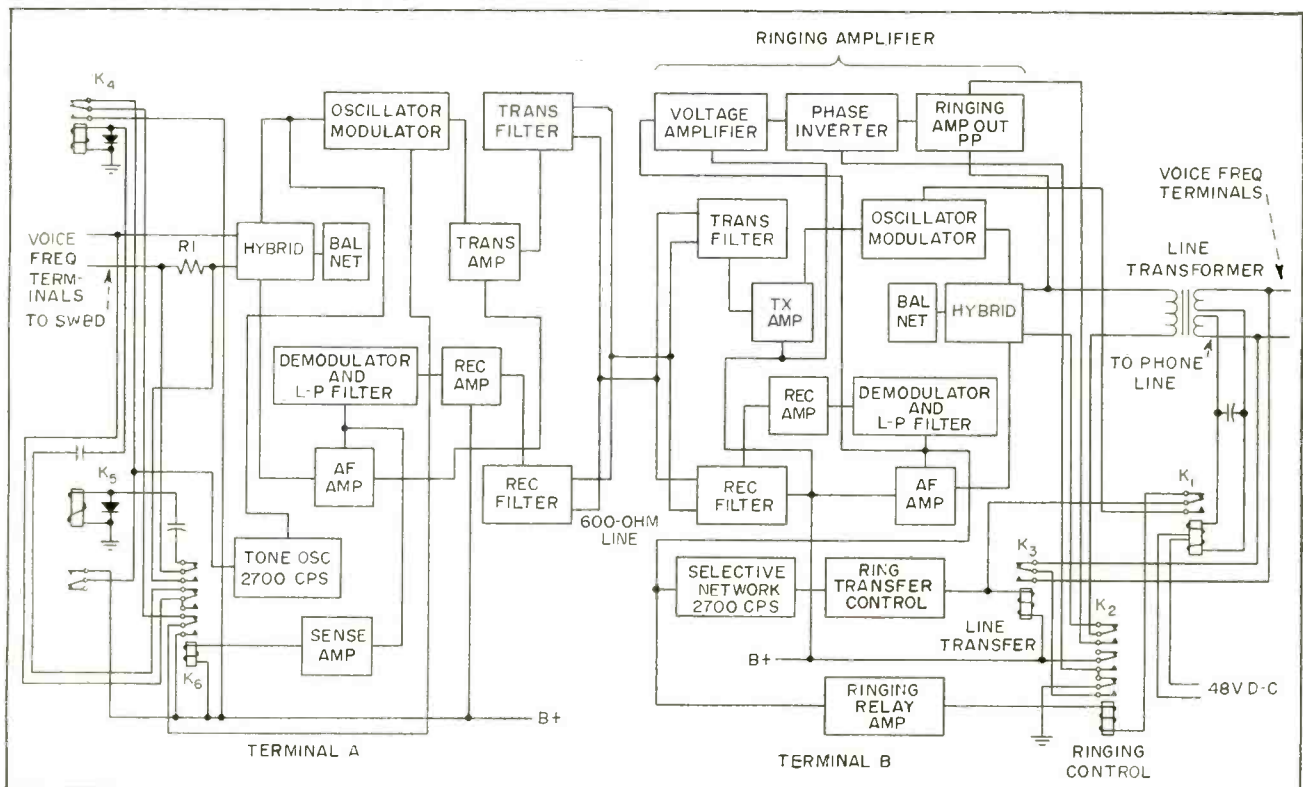
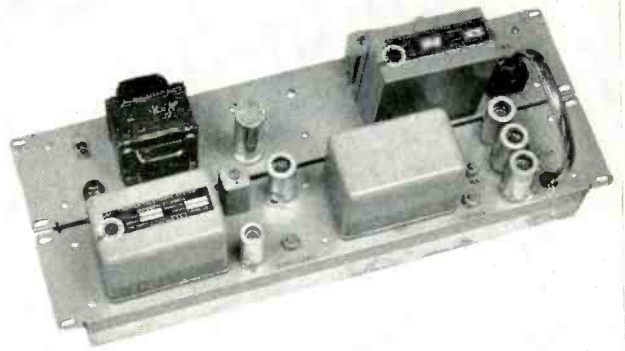
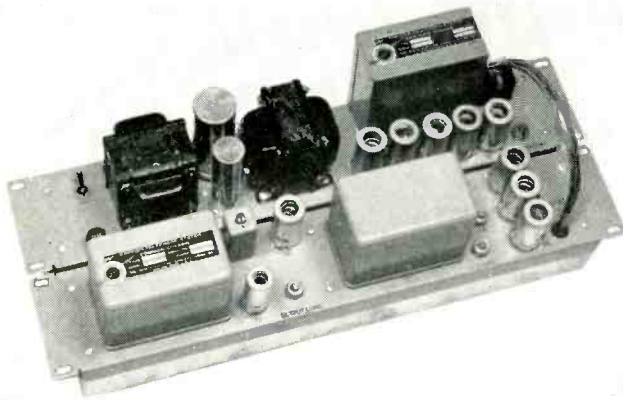

FIG. 1—Block diagrams show central-office terminal equipment (A) and remote terminal equipment (B)



Carrier terminal equipment (left) used at remote location to feed telephone sets. Central-office terminal equipment (right) drives 600-ohm two-wire line. Lower chassis of each terminal set contains common transmitting and receiving circuits

# Expands Rural Service

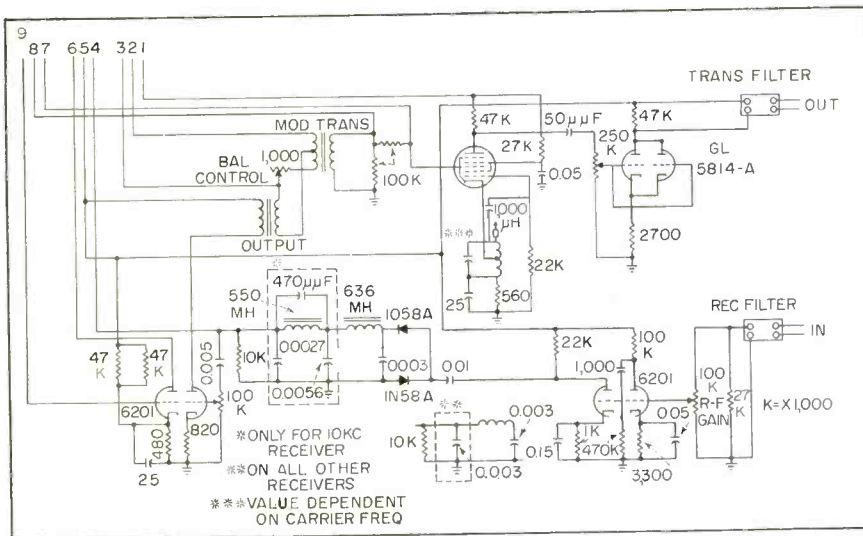

FIG. 2—Schematic shows transmitting and receiving circuits common to either central-office or remote terminals. Lower chassis in photographs contains circuit

more than 3 db down from 1,000 cps reference level at the 250 and 3,000 cps points.

Carrier terminating equipment should be arranged for interconnection with either automatic or manual switchboards.

Telephone ringers are required either across the wire circuit (bridged) or from each side of the wire circuit to ground (divided), with ringing frequencies extending over the range of 16 to 66 cps.

Response is needed to all supervisory signals from automatic or manual switchboards and a source of voltage is required for opera-

tion of carbon microphones.

Terminals should have low power consumption and twelve separate channels should be stackable on a pair of wires.

A high degree of stability is needed over a wide range of temperature and humidity conditions and installation, test, and maintenance should be simple. Total cost per channel is preferable around \$500.00 to encourage widespread economical application.

## Typical System

The block diagrams of Fig. 1, and schematics of Fig. 2, Fig. 3

and Fig. 4 show a double-sideband subscriber carrier system of recent design.

The carrier is transmitted at full level. The transmitter and modulator functions are combined in a single electron-tube operating as a suppressor-grid modulated oscillator.

The transmitter output is +15 dbm maximum into a 600-ohm line.

Modulating percentage with a -10 dbm level at 1,000 cps into the voice terminals varies from 60 to 90 percent.

The receiver employs a conventional two-stage amplifier with manual gain control. It is followed by a voltage doubler type of detector while a low pass filter removes the carrier component.

The photographs show a complete channel consisting of the remote terminal (terminal B) and the switchboard or central office terminal (terminal A).

## Circuit Operation

In Fig. 1, the central office terminal A is shown connected to an automatic switchboard. The switchboard connects an incoming call to the carrier-switchboard line-pair and applies a ringing voltage from either side of the voice frequency terminals to ground as directed by the switchboard. This ringing voltage operates either ringing relay

$K_4$  or  $K_5$ . Operation of  $K_1$  energizes the local transmitter. The ringing voltage directly modulates the transmitter and this modulated carrier signal is transmitted to terminal  $B$ .

At terminal  $B$ , the modulated carrier frequency is demodulated. The ringing voltage operates relay  $K_2$  which places  $B+$  on the ringing amplifier, transfers the line transformer from the hybrid to the ringing amplifier output and extends ground to the selected side of the voice frequency terminals.

The ringing voltage is also fed to the input of the ringing amplifier, thence applied to ringers of telephones to reach the desired subscriber. When the called party answers, relay  $K_1$  will operate and immediately disable  $K_5$ , disconnecting the ringing amplifier and connecting the voice frequency terminals to the hybrid. This energizes the local transmitter which sends the carrier signal to terminal  $A$ .

At terminal  $A$ , the carrier signal operates relay  $K_6$  which disables ringing relays  $K_4$  and  $K_5$  and removes the series resistor  $R_1$  allowing the seizure of the switchboard line relay. This relay operation energizes the carrier transmitter

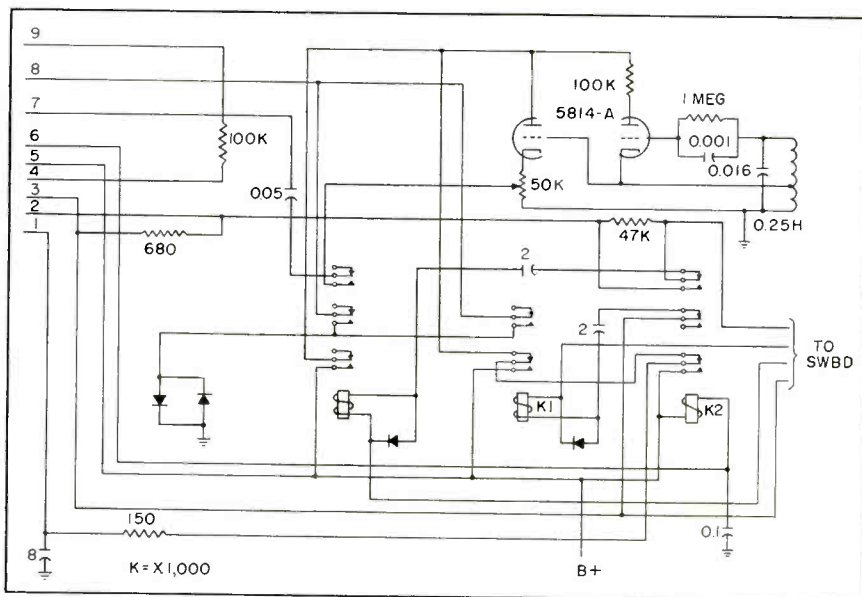

FIG. 3—Tone oscillator and relay circuits associated with central-office terminal

at terminal  $A$ , and connects through the switchboard to the calling party.

Replacing the handset at terminal  $B$  deenergizes its carrier transmitter releasing  $K_6$  at terminal  $A$ , reconnecting ringing relays  $K_4$  and  $K_5$  to the voice frequency terminals and sending the hang-up signal into the switchboard by reinsertion of series resistor  $R_1$ .

At the origin of this sequence, had relay  $K_5$  operated at terminal  $A$ , in addition to the described operations, the 2,700-cps tone oscillator would have modulated the carrier signal as well as the ringing voltage. The tone being received at terminal  $B$  would then have operated the line transfer relay  $K_5$  which applies the ringing voltage from the opposite side of the voice frequency terminals to ground.

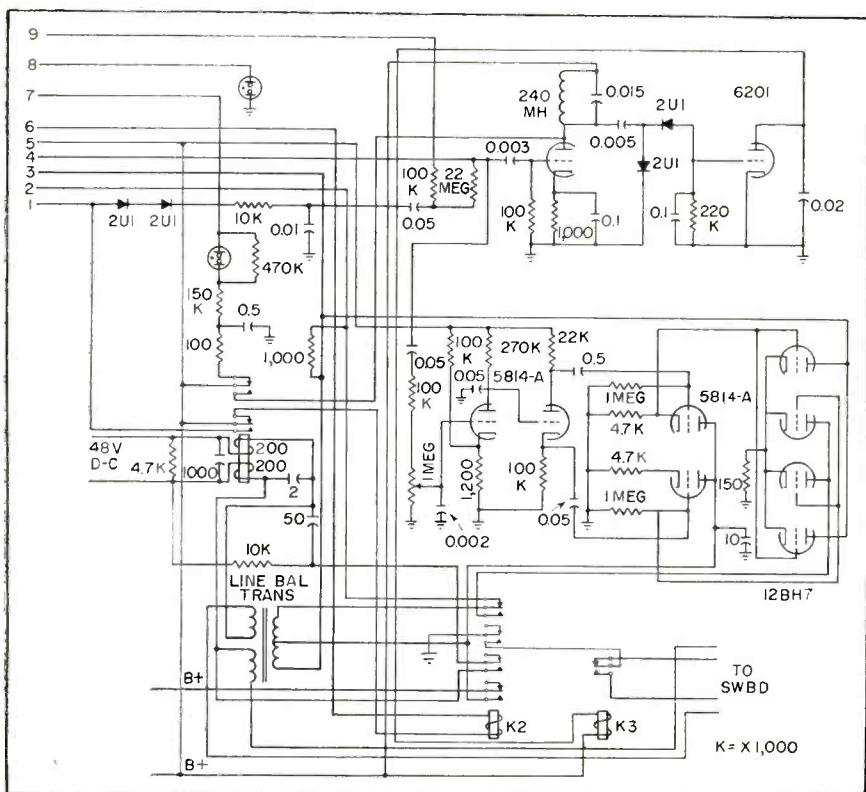

FIG. 4—Ringing amplifier, transfer control and relay circuits associated with remote terminal equipment provide path to reach desired subscriber

### Conventional Circuit

A carrier-terminal subscriber call through the exchange switchboard to a telephone subscriber on a conventional telephone circuit proceeds as follows. Lifting the telephone handset operates relay  $K_1$  at terminal  $B$ , which energizes the transmitter, sending a carrier signal to terminal  $A$ . In addition,  $K_1$  disables  $K_2$  so that false operation of  $K_2$  cannot occur.

At terminal  $A$ , the rectified carrier signal operates  $K_6$ , which removes ringing relays  $K_4$  and  $K_5$  from the circuit. Relay  $K_6$  also disconnects the series resistor  $R_1$ , allowing seizure of the switchboard line relay and returning dial tone over the carrier channel to the subscriber at terminal  $B$ .

The subscriber at terminal  $B$  dials, interrupting  $K_1$  causing interruption of the carrier signal at the dialing rate. These interruptions are transmitted to the switchboard line relay through  $K_6$  at terminal  $A$  signalling the called party.



ADHESIVES .....	186
CASTING RESINS .....	188
CERAMICS AND MICA .....	192
COATINGS AND TAPES .....	194
FOAM PLASTICS .....	196
GLASS .....	200
LAMINATES .....	202
MAGNETIC MATERIALS .....	204
METALS AND CHEMICALS .....	208
PLASTICS .....	210
WIRES .....	214
SOLDERS AND FLUXES .....	216

# MATERIALS for Electronics

By **JOHN MARKUS**

Associate Editor

and **DAVID A. FINDLAY**

Assistant Editor

© McGraw-Hill Publishing Company

An  
**electronics**  
Special Report

OCTOBER • 1956

# MATERIALS for ELECTRONICS

## adhesives now work hand-in-hand with rivets, bolts, screws, solder and welds

*New adhesives make news because their uses parallel both the fastening and hermetic sealing fields. For lap joints in electronic housings they give strong and leakproof joints*

**EPOXIES**—Practically all epoxy adhesives adhere well to metals, glass, ceramics and plastics.

Desirable qualities include high shear strength after curing, along with high impact strength and low shrinkage. Mica and other fillers further reduce shrinkage over the working temperature range.

Epoxy adhesives are available in three forms. There are one-part pastes or putties that are cured by heat; these are also available in molded rods for wiping of preheated joints, and as dry powders. The basic form, however, is a two-part combination cured by catalyst with or without heat. Three-part combinations give control over the amount of powdered filler included. Characteristics of typical examples are given in the accompanying table. Others include Aritemp 403 (Aries Labs); Bondmaster M620 (Rubber & Asbestos Corp.) heavy 1-part filled paste; Hysol 2-part filled (Houghton Labs); Dixon W-10 (Dixon Corp.) giving up to 40 lb peelback strength and 300 psi shear strength on fluorocarbons; Nureco GR 701 (Nureco, Inc.) 1-part for cementable Teflon; Superhold (Louis Labs).

Epoxy adhesives can be used for holding together the laminations of iron-core transformers and chokes. The laminations are coated with the adhesive, assembled and cured under light pressure. Stacks assembled in this way are usually quiet because laminations are permanently anchored right out to the edges. Moderately flexible epoxies give the best results here; highly rigid epoxies cured to maximum hardness can boost coil losses as high as 12 percent if they apply external stress to the magnetic material.

In one example of the use of adhesives for assembly, a Fairchild playback cartridge using Mylar film, aluminum, mu-metal, sintered iron, Alnico, copper, rubber and brass is assembled with a Bondmaster epoxy-polyamide adhesive which cures in 24 hr at room temperature or can be cured in one hour at 212 F. Many other cements are available for such operations, including plastic cements by Emerson & Cuming, Putite 1B waterproof adhesive by Ever-

Plastic Corp. and quick-drying Ambroid cements (Ambroid Co.) having high dielectric strength.

Where dissimilar metals are to be joined, use of an adhesive reduces or eliminates galvanic corrosion.

In general, phenolic or epoxy-phenolic resins are used where high shear strength is required at high temperatures (up to 500 F). Where temperatures range to 200 F, epoxies are valued for their ease of application, room-temperature curing and bonding by contact pressure.

Addition of fillers such as asbestos or aluminum dust to an epoxy adhesive increases both shear strength and temperature rating; 2,000 psi at 300 F may soon be achieved with a filled epoxy adhesive.

Flexible adhesives that will withstand up to 500 F in nonstructural applications are already part of the silicone group. Experimental resins are being synthesized currently to boost this limit to 600 F. In the other direction, work is under way at such establishments as the Forest Products Laboratory to boost shear strength above 4,000 psi at room temperature.

**SILICONES**—Silicone adhesives are pressure-sensitive, providing good adhesion to virtually all surfaces over the temperature range of -80 F to 500 F or more. They are particularly adhesive to such normally adhesive materials as silicone rubber, fluorocarbons and silicone-varnished materials. One use is in making pressure-sensitive insulating tapes. Another is the bonding together of small parts prior to installation.

An example is Dow-Corning C-269, which is a nontacky, viscous liquid that can be applied by knife coating or can be diluted for brushing, spraying or dipping. The solvent is then removed by air drying or by heating for 15 to 30 min at 150 F to 200 F. The resulting coated surface requires no further treatment. It can be joined to any clean surface regardless of whether that surface is -80 F or 500 F. Shelf life is over one year, dielectric strength is 600 v/mil, dielectric constant at 100 cps is 2.8, dissipation factor is 0.005 and surface resistivity is 2,000 megohms.

When used to make pressure-sensitive silicone-varnished glass cloth tape, C-269 is applied to the tape and cured 5 min at 480 F; the resulting tape carries a class H rating. Where such high curing temperatures are not permissible, C-271 may be used.



## TYPICAL EXAMPLES OF NEW AND IMPROVED EPOXY ADHESIVES

Product	Curing Schedule	Comments
<b>Araldite 502</b> (Ciba) 2-part; unreinforced; clear	7 days at room temp or 8 hr room plus 14 hr at 140 F or 8 hr room plus 2 hr at 212 F	Contact-pressure laminating resin. Volume resistivity is $8 \times 10^{13}$ ; surface resistivity is $5.7 \times 10^{12}$ ; dielectric strength is 500 v/mil; dielectric constant is 3.8 and loss factor 0.02 at 1 mc. May be used with glass cloth. Shelf life 1 yr; pot life 40 min
<b>Armstrong A-2</b> (Armstrong Cork Co.) 2-part	5-6 days at room temp or 2 hr at 165 F	Values for activator B; others give different pot lives and cure cycles. Activator B is highly volatile. Volume resistivity is $5 \times 10^{10}$ , minimizing galvanic corrosion. Dielectric constant is 5.24 and loss factor is 0.25 at 10 kc. Pot life 2-3 hr. Shear strength 4,000 psi. For -100 F to 220 F
<b>Armstrong A-6</b> 2-part	45 min at 200 F	For steel to steel, gives up to 4,500 psi. Cure is with activator E; activator A gives fast initial set at room temp but requires 6-7 days at room temp for full strength and gives 40 minute pot life. Armstrong A-5 has aluminum-powder filler, gives up to 2,000 psi for aluminum to aluminum. A-4, also metal-filled, gives up to 2,000 psi for aluminum. Pot life 2-3 hr. Shear strength 3,000 psi
<b>Biggs R-823</b> (Carl H. Biggs Co.) 2-part; thin liquid; clear	2-3 hr at room temp	No single solvent yet found will soften when fully cured (after 16 hr at room temp). For applying thin glue line, and for bonding core laminations. Cures transparent; gives moisture protection for bonding and pressure-sealing windows of meters. For hermetic sealing of capacitors, etc. Volume resistivity is $2.5 \times 10^{13}$ ; dielectric constant is 4.7 and loss factor 0.19 at 10 kc. Shear strength 2,000 psi. Pot life 1 hr; shelf life 2 yr. For -100 F to 350 F
<b>Biggs R-313</b> 2-part; clear	2 hr at room temp	Similar to Biggs R-823 except soaking several hours in Biggs solvent 101 will soften. Used also to bond copper foil to plastic laminates for etched wiring, and for bonding mica to itself or to metal. Ultimate shear strength of 3,200 psi in 16 hr. Shelf life 2 yr; pot life 1 hr
<b>Biggs R-835</b> 1-part heavy paste; adhesive filler	1 hr at 325 F	Developed as adhesive for metal honeycombs, to withstand 500 F generated by air friction in supersonic aircraft and guided missiles. Heating in water bath to 200 F makes it easier to apply. Coated parts may stand several days before baking. Pot and shelf life 1 yr. Shear strength 3,500 psi. Good to 500 F
<b>Tygoweld 30-B</b> (U. S. Stoneware) 2-part; heavy paste; metal filled	6 days at room or 1½ hr at 180 F or ¾ hr at 220 F	High shear for nonferrous metals and rigid dissimilar materials. Use 27-B with same characteristics for ferrous metals. Shear strength 2,500 psi. Shelf life 12 mo; pot life 3 hr. For -60 F to 275 F
<b>Tygoweld 114</b> 1-part; fluid unfilled	1-2 min at 450 F or 60 min at 250 F or 5 hr at 220 F	Temperature-indicating; changes to clear amber at 450 F. Shear strength 2,000 psi. Shelf life 6 mo. Good to 375 F
<b>Tygoweld PB-1</b> 1-part; alloyed epoxy extruded rod	3 min at 500 F or 80 min at 338 F	Temperature-indicating rod; changes from dark green to amber at 482 F when cured. Heat work to 300 F or higher, then wipe on. Type III color changes from aluminum to gray. Type II has no color change. Type I is a color-changing 200-mesh powder. Will not adhere to fluorocarbons, rubber, polyvinyls or most silicones. Shear strength 4,900 psi. Good to 350 F

**LIQUID LOCKNUTS**—A thermosetting liquid plastic developed by American Sealants Co. locks threaded fasteners such as the positioning nut for the shaft of a variable tuning capacitor. A drop of the liquid applied to the tightened nut penetrates the threads. Curing is initiated by absence of air and accelerated by catalytic action of the metals being locked.

Maximum strength is obtained in 24 hours at room temperature, and is adjustable to meet various needs. Locked joints can be loosened with ordinary tools.

The material will also penetrate and seal pores in aluminum and other castings, bond glass to itself or to metal, and bond sleeve joints in metal. In air it remains for days as a semi-liquid film, so that bolts can be treated in bulk and stored for days before assembly. Surplus can be wiped off after assembly.

**LAMINATING ADHESIVES**—A laminate currently in wide use is an absorbent paper bonded with a phenolic resin (known as XXXP), but many other combinations are also coming into use or are under

development. These generally use paper, glass cloth, cotton fabric or Orlon fabric as the base and various forms of phenolic, epoxy, silicone, polyester, melamine or dialphthalate resins as the adhesive or bonding.

As one example of a modern adhesive, Armstrong's D-253 makes possible new assembly-line techniques in producing laminated sandwiches because the bond is instantaneous. A conveyor brings the sheets under adhesive spray guns, then through an infrared drying oven to pressure rolls that make the bond.

**Give consideration to new  
adhesive fastening methods  
that hold through severe  
vibration tests now called for  
by military specifications**

# casting resins are here to stay as a method of housing components

*Modern resins and alloys broaden working temperature ranges of equipment, improve electrical performance and serve as packaging. Curing time, curing temperature and pot life can be tailored to meet production requirements*

**EPOXIES**—High adhesion and low moisture absorption are among the features of epoxies. Mechanical strength is good and shrinkage is low. Depending upon the hardener used, epoxies are either cured at room temperature and then post-cured in ovens to develop maximum properties, or cured completely at temperatures of 200 F and above.

If coils and precision resistors are wound on epoxy resin bobbins or forms and then encapsulated with an epoxy resin, an integrated all-epoxy structure is obtained which overcomes the problem of differential coefficients of thermal expansion. In one example, an epoxy rod cast from Scotchcast No. 5 (Minnesota Mining) by Polytronics, Inc. is machined into a bobbin for a precision resistor. Similar epoxy resin bobbins are available in finished form from Thor Ceramics.

A variation of this technique, involving use of lengths of epoxy tubing as one-shot molds for encapsulating coils, is used by Deluxe Coils; after curing, no demarkation can be seen at the fusion of the tubing with the newly poured epoxy.

Round, square and rectangular tubing made from epoxy-impregnated glass cloth by Furane Plastics and others is widely used for coil forms scheduled for later solid epoxy encapsulation.

Epoxies adhere so well to both metals and non-metals that separating agents are generally required for molds. Silicone products such as Dow-Corning 200 oil and DC 11 grease will give clean parting. This coating must be renewed after each use. Where high production is involved, a thin coating of Teflon can be sprayed on the mold and sintered at 750 F. There is also a Dow-Corning silicone varnish called Pan Glaze, which is sprayed on the cleaned mold surfaces and baked.

In addition to the two-part materials tabulated here, other new or improved encapsulating epoxies include Marblette 622B (Marblette Corp.) for overnight cur-

ing at room temperature; Epon (Shell Chemical Corp.); Colplast (Topper Mfg. Co.) for room-cure encapsulating of semiconductor circuits; Bakelite's epoxy resins; Resin 2255 (Boston Div., U. S. Testing Co.); Araldite 502 and other basic epoxy resins (Ciba Co.) for use with various hardeners and fillers; Scotchcast filled or unfilled and rigid or flexible types (Minn. Mining); Melpak V BM (Melpar).

Single-component epoxy casting resins requiring only heat for curing are now available from companies such as Aries Labs (Aritemp 201 and 202). These particular products are cured at 255 F, rated for class H and come as free-flowing powders. Dielectric strength is 500 v/mil for 202 and 700 v/mil for 201.

Leadcast (Telectro Industries) is a filled epoxy that is 95 percent lead by weight, for producing homogeneous castings used as radiation shields for x-rays, gamma rays and neutrons, or as a high-density molding compound.

**POLYESTERS**—Though similar to epoxies in electrical characteristics, polyesters are most often used in low-frequency applications.

Typical of new polyester resins are four made by Electronic Plastics Corp. Their EP-220 is a general-purpose casting resin that can be cured in less than 5 min. at room temperature, withstands -85 F to 300 F and is nontoxic. EP-320 is nonshrinking during cure and has low curing exotherm, for delicate components requiring protection from temperature and pressure. EP-422 is fiber-reinforced for greater strength, permitting 10-lb and larger castings in production. EP-681 cures at room temperature also and remains flexible enough to permit large metal inserts as in transformer encapsulation.

Four-part epoxy-modified polyesters by Acme Wire Co., such as Acme 2008, permit varying the ratios of base, activator, hardener and filler to get a wide variety of characteristics, including working ranges of -65 F to 355 F. A typical curing cycle is 3 hr in mold at 230 F plus 3 hr in air at 230 F after removing from mold.

Typical Emerson & Cuming casting resins include Stycast 4030 CM for general use. Stycast 40 is an unfilled polyester that cures up transparent, and is thus used for preliminary embedments where visual

## DEFINITIONS

*Until recently the potting of electronic units was generally done by placing the units in metal cans and pouring in a hot pitch or similar asphaltic material. Now the can is being replaced by a reusable casting mold. As a result, terminology is in an interim state of confusion.*

*In the aircraft industry, potting now usually means embedment, encapsulation or impregnation of electronic components with resins. In the electronic industry, potting usually still means the hot pitch and can technique; encapsulation and embedment are used interchangeably for the new casting resin techniques.*

*Impregnation still means what it always did — a thorough soaking, usually in a vacuum.*

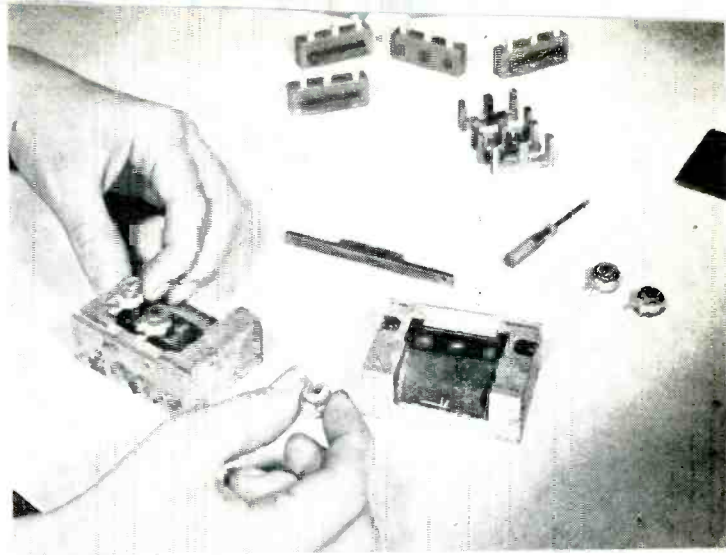

Placing coils of missile gyro pickoff assembly over core legs in aluminum mold, in preparation for encapsulating with Laxolene modified epoxy resin at Deluxe Coils plant

inspection is desired. Ecco W 44 HT is an impregnating resin when used alone, and becomes a casting resin when filler is added, while Stycast 62 is strictly a polyester-type impregnant for capacitors and coils.

**POLYSTYRENES**—The styrene-type casting resins have excellent electrical properties, particularly at high frequencies. On the other hand, styrenes have a relatively low heat distortion point, and hence are rarely used at temperatures much over 185 F. They require a relatively long cure time and can shrink up to 25 percent by volume during curing.

Polystyrene casting resins are used extensively in r-f and microwave embedment applications, as a low-loss impregnant for coils and capacitors and as the resin for flexible low-loss glass fiber laminates, because of their low-loss characteristics.

Typical of polystyrene casting resins is Stycast 35, having a useful temperature range of -5 F to 185 F, dielectric strength of 600 v/mil, dissipation factor of 0.0008 and dielectric constant of 2.59 to 10<sup>9</sup> cps and a resistivity of 10<sup>14</sup> ohm-cm. Stycast TPM-2 is another low-loss casting and impregnating resin, having a still lower dielectric constant (2.32) and a dissipation factor below 0.0006 up to 10<sup>10</sup> cps; cure overnight at 120 F plus 4 hr at 175 F.

**POLYSULFIDES**—Where flexibility is required along with oil resistance and good electrical insulating properties, polysulfides are widely used for encapsulating. Typical applications are as dielectric sealers for electrical connectors and as protective coatings.

Representative of the newer polysulfides is Ecco CPC-2 which has a pot life of 90 min after mixing, cures in 24 hr at room temperature, withstands -70 F to 220 F, has a dielectric constant of 7.7 and dissipation factor of 0.03 to 10<sup>10</sup> cps, a dielectric strength of 230 v/mil and a volume resistivity of 2 x 10<sup>14</sup> ohm-cm. Other examples include Elastiseal (Ellanar Chemical Co.) and Pro-Seal 727 (Coast Pro-Seal & Mfg. Co.).

**SILICONES**—When encapsulating, a preliminary coating with a resilient material such as a polysulfide or a silicone rubber can prevent damage to tubes and



One-tube assembly before and after encapsulation with Eccofoam GL phenolic-epoxy powder (Emerson & Cuming; that foams when heated). Socket is flush with rear side of embedment. For temperatures up to 600 F, same firm's Stycast 2662 epoxy resin is used instead

Sealing connectors for TM-61 Martin Matador tactical missile with synthetic rubber while fixtures and clips center wire leads



## EXAMPLES OF NEW TWO-PART EPOXY ENCAPSULATING RESINS

Trade Name & Manufacturer	Curing Schedule	Dielectric Constant	Dielectric Strength v/mil	Dissipation Factor	Continuous Temperature	Comments
Aritemp 316 (Aries Labs)	.....	3.7 (60 cps)	500	0.0018 (60 cps)	-65 F to 300 F	Fire-retardent and self-extinguishing
Aritemp 325	May be cured at room temperature	3.9 (60 cps)	500	.....	.....	For dip coating. Low moisture absorption and high insulation resistance. Thickness of coating can be adjusted
Aritemp 308B-6ST	Low-temperature cure	.....	450	.....	-110 F to 265 F	Low exotherm during curing. High humidity resistance
B-415 (Carl H. Biggs Co.)	24 hr at room temperature	4.55 (100 kc)	..	0.005 (100 kc)	-80 F to 250 F	Transparent and somewhat flexible after cure. For encapsulating amplifiers, transformers, resistance bridges and coils. Compounds P-420 and P-460 are similar. Pot life 8 hr
C-4 (Armstrong Products Co.)	3 hr at room plus 30 min at 170 F	3.18 (1 mc)	435	0.086 (1 mc)	.....	No filler. Available in various formulations. Pot life 35 min
EP-1014 (Electronic Plastics Corp.)	1½ hr at 250 F plus 24 hr at 355 F	2.4 (100 mc)	686	0.011 (100 mc)	-85 F to 445 F	Post-curing gives continuous temperature resistance to 495 F and short-time resistance to 570 F
Epocast 13 (Furane Plastics; Permacel Tape Corp.)	2 hr at 250 F or 5 hr at 200 F	2.8 (11 mc)	..	0.014 (11 mc)	-65 F to 300 F	Long pot life (1 week), yet quick cure and good mechanical and electrical properties. No dermatitis
Epocast 15	6 hr at 200 F or 3 hr at 250 F	3.5 (11 mc)	400	0.038 (11 mc)	-65 F to 300 F	Clear modified epoxy resin for encapsulating and sealing applications requiring semirigid low-strain material. Pot life 4 days
Freed Resin D (Freed Transformer Co.)	4 hr at 212 F or 5-15 min at 392 F	.....	..	.....	-85 F to 392 F	Can be mixed and poured at room temperature. High dielectric strength. Pot life 90 min
Hysol 6600 (Houghton Labs)	24 hr at 230 F or 7 hr at 284 F or 1.5 hr at 338 F	3.56 (1 mc)	..	0.0194	300 F	Resilient to allow for differential coefficients of thermal expansion. Hysol 6800 is less resilient and lower in price
Nureco GR 101 (Nureco, Inc.)	.....	5.0 (1 kc)	435	0.023	-65 F to 100 F	Rigid but nonbrittle polysulphide epoxy type
Randac R-4058 (Mitchell Rand)	4.25 hr at 165 F plus 5 hr post cure at 212 F	4.39 (1 kc)	..	0.006 (1 kc)	Class A	Heavy dip coating easily applied at 200 F, at which pot life is 1 hr. Lasts 1 week at room temp
Randac R-4060	6-10 hr at 212 F or 3-6 hr at 300 F	3.8 (1 kc)	..	0.0038 (100 cps)	to 275 F	Designed for vacuum encapsulation. Volume shrinkage 1.2% during cure. Pot life 3 days
Randac R-4061	2-4 hr at 212 F or 15 min at 255 F	13.6 (1 kc)	..	0.019 (1 kc)	.....	Mineral-filled. Designed primarily for making low-cost molds for encapsulating applications
Stycast 2662 (Emerson & Cuming)	3 hr at 212 F	3.0 (10 <sup>9</sup> cps)	420	0.01	-94 F to 500 F	Withstand 600 F for short time. Pot life 2 days. Rod and sheet form is R25
Stycast 109D	24 hr at room or 1 hr at 212 F	3.8 (10 <sup>9</sup> cps)	400	0.03	-110 F to 400 F	Low weight (0.9 specific gravity). Pot life 30 min to 4 hr, depending on catalyst used
Stycast 2340M	4 hr at 200 F or 12 hr at 150 F	3.5 (10 <sup>9</sup> cps)	500	0.045 (10 <sup>9</sup> cps)	-100 F to 400 F	Flexible epoxy coating resin. Cures tack-free even when exposed to air
Stycast 2850GT	24 hr at room temp or 1 hr at 212 F	4.7 (10 <sup>2</sup> to 10 <sup>10</sup> cps)	455	0.02 (10 <sup>10</sup> cps)	-130 F to 392 F	Low shrinkage during curing. Low expansion coefficient. Will withstand 500 F for short time
Versamid 125 (General Mills)	2 hr at 150 F or 10 min at 300 F	3.1 (1 mc)	430	0.06 (1 mc)	-65 F to 265 F	Polyamide hardener for combining with liquid epoxy resins such as Bakelite ERL 2795, for which typical values are given. Nontoxic. Pot life 90 min

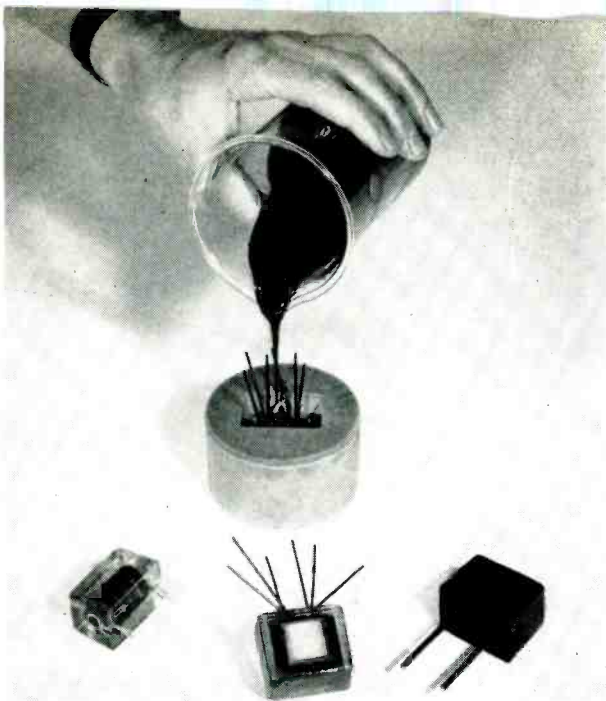

Pouring Randac R-4060 epoxy resin around small transformer in mold

other delicate components by shrinkage during curing or temperature cycling.

Where flexibility is required along with good dielectric properties and good thermal conductivity up to 500 F, the use of silicone rubbers also becomes justified for dipping and brushing applications. Feasibility for encapsulating is currently being evaluated.

Silicone rubbers are furnished as two components which are diluted with toluene before mixing. The diluted mixture is applied by dipping or brushing, followed by curing at room or slightly elevated temperatures. Additional coats, each followed by curing, may be applied to build up the thickness.

Silicone rubbers have good corona, ozone and electrical fatigue resistance, high resistance to arcing and excellent heat stability. Typical examples of new formulations include Melcoate I by Melpar and RTV Silastic by Dow Corning.

**METAL PUTTIES**—Precision castings for microwave radar and other electronic equipment need no longer be scrapped because of blow holes, small gas holes, sandpits, cracks, nicks, scratches, porous areas or machining flaws. New metal-filled epoxies provide the practical repairs.

One example is Flawmaster (Carl H. Biggs Co.), furnished as a kit containing a can of resin, a bottle of hardener and a supply of blended finely powdered metals. Varying the amount of filler changes the compound from a free-flowing liquid for fine cracks and holes to a heavy paste or putty for large repairs or for covering countersunk screw heads. The powdered metal filler is available in aluminum, brass, bronze, zinc, iron and magnesium to match the object being repaired, as well as in steel and other metals. Powders can also be blended to match the color of the base metal. The putty hardens in about 4 hr at room temperature. After this, any surplus can be ground or sanded off the surface, to get a practically undetectable repair. Volume resistivity is  $2.5 \times 10^{10}$ .

Formex 77 (Travaco Labs) is another example of

a self-hardening plastic metal compound. This comes as a two-part material having a pot life of 3 to 80 minutes after addition of the catalyst and a curing time of 1 to 3 hours. It can be brushed, poured, applied with a putty knife or pressed in place, and will hold any shape to which it is molded, without sagging. The cured surface has a smooth fine grain that sands and machines like soft gray iron. Normal temperature range is  $-60$  F to 300 F, but the cured material will take up to 650 F for a few seconds at a time. Surfaces may be built up to any thickness in one operation. Adherence is also good to wood, glass, unplasticized plastics and ceramics. The powdered metal filler is normally nonmagnetic, but Formex 5 comes with about 75 percent finely powdered steel filler for magnetic assemblies.

**FILLERS**—Selection of the proper type and amount of filler added to epoxy or polyester resins is highly important in encapsulation. Examples include aluminum oxide, asbestos, calcium carbonate, glass beads, glass powder, glass flakes, glass fibers, mica, quartz, silica, talc, powdered metals like aluminum and steel, and clays such as bentonite. Calcium carbonate is generally used only with epoxies, because it causes premature gelation of polyesters.

**SOLVENTS**—Rejects after encapsulation with epoxy or polyester resins may be reclaimed by immersing in a solvent such as one brought out by Ram Chemicals as De Solv 292. This disintegrates the resin, permitting removal of components for repair and reencapsulation.

**TRENDS**—Laboratory reports indicate that new mixtures of various resins will make news in the early future.

Such combinations as epoxy-polyester, epoxy-Thiokol, epoxy-phenolic and epoxy-polyamides have already been developed or are being worked on; these are being called epoxy alloys. Illustrative of those already available is Electroplast, a room-curing Teflon-based copolymer brought out by Topper Mfg. Co.

The aircraft industry expects to be confronted with a 500 F to 600 F temperature problem within the next 3 to 5 years. This means that connector-encapsulating resins and wire insulation both must be radically improved temperature-wise.

Can one of the modern  
encapsulating plastics solve  
packaging, mechanical, electrical  
and other problems simul-  
taneously in your new design?

# ceramics and mica for high dielectric strength at high temperature

*Dipped and sprayed ceramic coatings raise upper temperature limit of electronic components. Thermal conditioning increases mechanical strength of ceramics. Bonding and use of synthetic mica provide large sheets with improved electrical characteristics*

**MOLTEN CERAMIC COATINGS**—Hard abrasion-resistant and heat-resistant coatings for thermocouple tubes can be obtained by the flame spray method. Powdered alumina and zirconia coatings 0.005 to 0.025 in. thick can be applied in molten form with flame-spray guns such as those made by Metallizing Engineering Co., using conventional oxyacetylene welding equipment.

Flame-sprayed ceramics that can be applied directly to most metals, glass and graphite have been developed by the Armour Research Foundation. Licensees like Continental Coating Corp. provide the coating in alumina, zirconia and titania.

An oxide spray coating announced by the Norton Co. provides high temperature and abrasion resistance as an insulation, wire coating and thermal barrier.

Three types of coating are available—aluminum oxide, zirconium silicate and stabilized zirconium. Aluminum oxide can be used in a thickness of 0.005 to 0.05 in. Heat resistance is 3,600 F.

**SOLUTION CERAMICS**—Nonbrittle ceramic coating material for resistors, capacitors or thermocouples can be made with a process developed by Armour. The liquid coating can be applied at temperatures in a range from 400 to 700 F. Metal coated with solution ceramic can be moderately bent and twisted without cracking the ceramic.

So far, zirconia, chromia, titania, ceria, and magnesia coatings have been developed. No adhesive or binder is used. The coating is resistant to heat and chemical attack, and forms a bond strong enough to be used as a base for other coatings.

Coatings a few millionth of an inch thick have been used to separate magnetic core laminations without significantly increasing their stacked thickness.

A thin magnesium oxide ceramic coating developed by the Materials branch of Signal Corps Engineering Laboratories retains its insulating properties up to 2,900 F. The ceramic solution is applied in a dipping bath and then dried.

**STRONGER CERAMICS**—A thermal conditioning process developed by the Signal Corps has been made available to the ceramic industry. After vitrification of the ceramic, the part is heated to 200 to 400 F below the curing temperature. A blast of room temperature air is then applied, forming a compression skin on the outside of the part.

The process increases impact strength of some ceramics up to 100 percent. Other mechanical properties are also improved.

**METAL-CERAMIC BONDING**—Metallized ceramic coatings can be applied to most ceramics to provide a soldering connection. A coating such as Frenchtown Porcelain Molcote can be hard-soldered at temperatures up to 2,200 F, providing a bond that is strong to the point of fracture of the ceramic. Solder used with the coating can be either silver or copper-base alloys or silver-copper eutectic alloys.

For hard and soft soldering a metallized coating such as Nicote can be used. Terminal leads can be hard-soldered to the coated terminal, after which the entire subassembly can be soft-soldered to other equipment without danger of loosening the previous

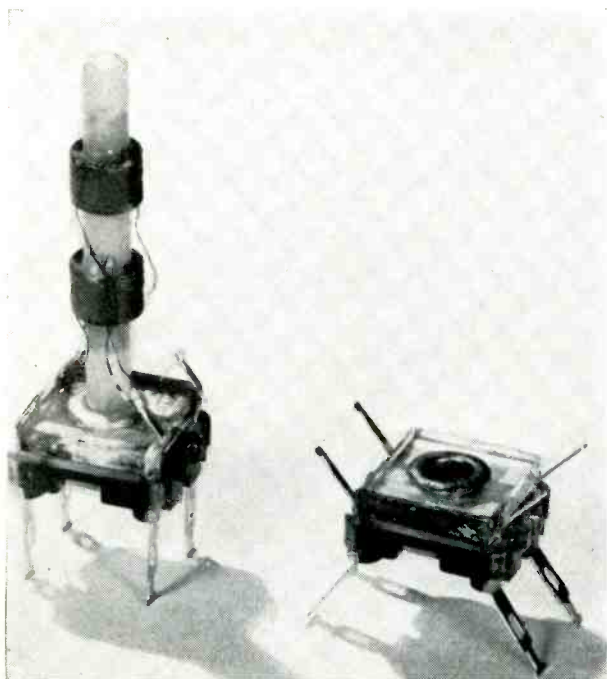

Silvered mica insulators in i-f transformer assembly also provide mechanical support and conductive paths



Flame-sprayed ceramic coating is applied to thermocouple tube using oxyacetylene equipment with special gun made by Metallizing Engineering

work. Soldering range is from 275 to 1,600 F. Both of these coatings are custom applied by Frenchtown.

Ceramic-to-metal seals using preformed rings of silver solder cored with titanium hydride have been used at Westinghouse Electric Co. The solder preform is placed between the parts in assembly and fired.

**SILICATES** — Lead-alumino-silicate and lithium-alumino-silicate have useful temperature characteristics for electronic applications. Lithium-alumino-silicate produced by Stupakoff Ceramic Co., for example, is highly resistant to thermal shock and can be cooled abruptly from 2,200 F to room temperature without damage. A zero or negative coefficient of expansion makes it useful in critically-tuned inductive and capacitive circuits where dimensional change might affect tuning.

Lead-alumino-silicate can be molded and fired to tolerances of 0.001 inch without need for grinding or lapping.

**STABILIZED ZIRCONIA**—A negative coefficient of resistivity is one of the major characteristics of this ceramic material produced by Norton Co. Specific resistivity at 1,290 F is 2,300 ohm-cm. At 3,090 F this value decreases to 1.6 ohm-cm. This characteristic is of value in uhf furnaces as a heating element.

**NATURAL MICA**—Mica flakes bonded with epoxy resins, silicone resins or shellac produce sheets comparable with large naturally formed sheets of mica. Heating and chemical treatment prior to bonding reduce the tendency of mica to outgas at elevated temperatures.

Upper operating temperature limit of sheet mica made by Mica Insulator Co. is determined mainly by the type of impregnant used. The composition can be from 65 percent to 95 percent mica, with the remainder bonding material.

In capacitor grades, the mica sheets before impregnation have a dielectric strength of 800 v/mil. After impregnation the value is 3,000 v/mil. Upper temperature limit is 500 F.

A 1-mil-thick mica mat treated with silicone is made by General Electric Co. for layer insulation in transformers and coils. It is flexible and can take small-radius turns without cracking.

A rigid mica sheet material similar to the flexible mat is available in thicknesses of 0.010 to 0.060 in. with a flexural strength of 15,000 psi.

Natural mica sheets are available from companies such as Perfection Mica Co. and United Mineral and Chemical Corp. A method of gaging developed by Perfection determines the capacitance per unit area of natural mica sheets. This permits selection of mica having a uniform capacitance and the utilization of smaller-area mica to obtain predetermined capacitance in mica capacitors.

**SYNTHETIC MICA**—Grown- mica crystals can now be obtained from companies such as Brush Beryllium Co. and Synthetic Mica Corp. without foreign impurities, eliminating outgassing at elevated temperatures. Synthetic mica is readily available in sheet sizes smaller than 2-in. square, with larger sizes in more limited supply. The material retains its electrical characteristics at high temperatures.

Flake synthetic mica bonded with high-temperature electrical glass can be obtained in forms suitable for molding or punching. Supramica 555, made by the Supramica Division of Mycalex Corp., is a moldable type that can withstand temperatures up to 950 F with absolute dimensional stability. Glass-bonded synthetic mica is also made by Electronic Mechanics, Inc.

Both moldable and sheet glass-mica materials have a coefficient of expansion comparable to that of steel, permitting inserts to be molded or cemented into place.

Nuclear radiation resistance of glass-bonded mica is high. Gassing or dimensional changes are not caused by bombardment, nor are secondary radiations or radioactive byproducts produced.

A self-bonded pure synthetic mica sheet now under development by Synthetic Mica Corp. will provide large-area pure mica sheets suitable for automatic progressive die-punching operations.

**Check ceramic coatings as a  
means of extending operating  
temperature range  
of your equipment**

# coatings and tapes offer extra protection and can save dollars

*Dip, brush and spray formulations and new tapes do old jobs better and solve problems created by advanced production techniques. Aerosol containers now supplement guns for greater convenience on small jobs*

**FOR PRINTED CIRCUITS**—Modified epoxy coatings can be applied to printed circuits after assembly by dip, brush or spray and cured at room temperature. These maintain surface resistance during and after high humidity and improve the mechanical bond between the wiring and base material. Hysol 6230 (Houghton Labs), a two-component dip or brush version with 8-hr pot life, gives good adhesion to melamines. Hysol 6231 for spraying is good for phenolic, epoxy and melamine laminates. EP-450 (Electronic Plastics Corp.) has two components, high adhesion, 24-hr pot life and good flexibility.

Varnish No. 642 (Schenectady Varnish Co.) similarly protects wired circuits against arc-producing moisture, can be baked or air-dried, and withstands 500 v/mil even after 72 hr at 100 percent relative humidity.

A resist coating for etched wiring, featuring freedom from pinholes and giving sharp silk-screen printing, is E12 Sharp-Etch Micropaint by Micro-Circuits Co.

**FOR CONTACTS**—Products like Cramolin (Craig Cosmopolitan) reduce contact resistance by dissolving oxide and sulfide layers on all contact metals, including gold alloys. A coating lasts 2 to 3 years normally and withstands -120 F to 450 F.

Epoxy-filled Scotch tape (Minnesota Mining) can be rapidly wrapped around paper capacitors in production

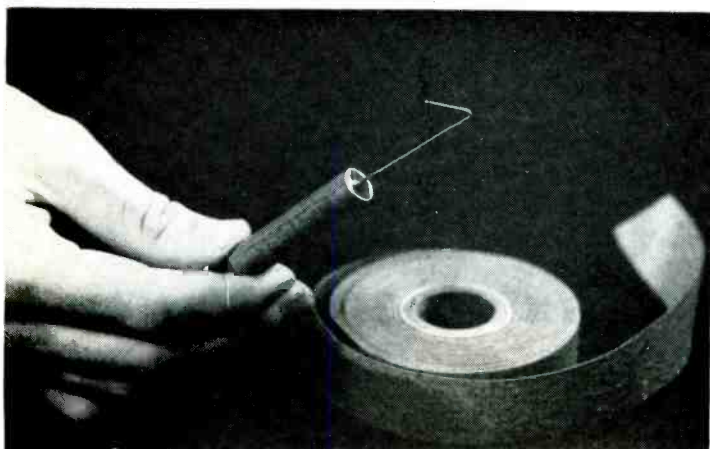

**FOR ELECTROPLATING**—A conductive coating for plating of holes in printed circuits is provided by dag No. 154 (Acheson Colloids Co.), a graphite-alcohol dispersion that can be sprayed, dipped or brushed. Resistance is 5,000 ohms for 0.00025-inch film. Forced drying at 200 F is recommended.

An air-drying silver conductive paint by H. V. Anderson Associates and by du Pont can be applied by brush, squeegee or spray to practically all plastics including polystyrene and fluorocarbons.

A thin film of pure silver having less than 2 ohms resistance per square inch is deposited by Met-Coat silver spray (Metz Refining Co.) for through-hole plating of printed circuits.

Metal films having a precisely controlled resistance in the range from 20 to 200 ohms per square and power-dissipating capacity of 4 w/sq in. are produced on low-loss glass blanks by IRC, Metavac and others for waveguide attenuators.

RS14 Shielding Micropaint (Micro-Circuits Co.) gives good conductivity when applied to relatively rigid surfaces for high-frequency shielding, high-voltage protection, grounding or as an electroplating base. RS17 is a flexible version having good adherence to polyethylene and a resistance of 25 to 50 ohms per square. No baking is needed.

**FOR PROTECTION**—Uniform coatings of nylon, polyethylene and other plastics can be applied to metals and many other base materials by Polymer Corp.'s Whirlclad process. The object is preheated above the melting point of the coating material, then suspended in a tank in which dry, finely divided powders of the plastic are fluidized by ascending currents of air.

A resilient coating for protecting vacuum tubes, toroids and other pressure-sensitive components prior

Mylar tape with combined thermosetting and pressure-sensitive adhesives anchors itself and cures when coil is baked after encapsulation

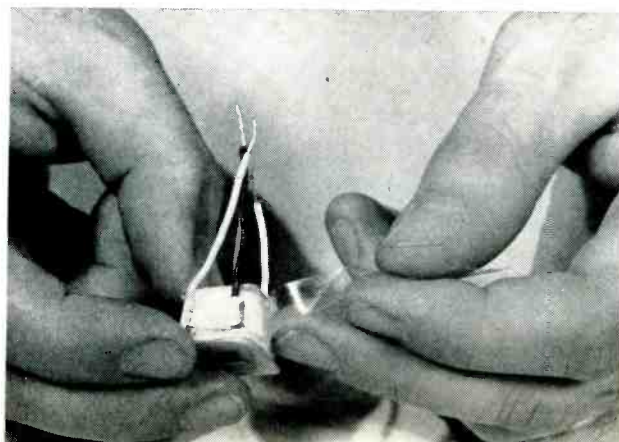



## EXAMPLES OF SPECIAL-PURPOSE TAPES AND FILMS

Aluminized Mylar (Wakefield Industries)	Thin conducting plastic membrane weighing 0.9 mg/sq cm is opaque to light, transparent to electrons and other particles, has only slight gas permeability
Nox-Tarnish (Daubert Chemical Co.)	Protective packaging paper used for temporary wrapping of silver-plated electronic components. Prevents formation of sulfides on silver and other nonferrous metals
Lexel (Dobeckmun Co.); Permacel (Permacel Tape Corp.); Scotch Brand (Minnesota Mining); Tuck (Technical Tape Corp.)	Polyester tape made of Du Pont's Mylar film in various widths and thicknesses, with and without thermosetting and/or pressure-sensitive adhesives. Thin, tough, noncorrosive tape having high dielectric strength and high insulation resistance. Some are available in colors for coding. When cured by heat, thermosetting adhesive versions provide permanent bonding. Widely used for fine wire coils.
CDF ET-1 (Continental-Diamond Fibre); Enflo (Enflo Corp.); Maigne (O. J. Maigne Co.); Scotch Brand (Minnesota Mining); Temp-R-Tape (Connecticut Hard Rubber); TCG (Warren Wire Co.)	Tetrafluoroethylene tape made of Du Pont's Teflon film in various widths and thicknesses. Available uncoated, treated to give a wetted, nonslip surface or having a pressure-sensitive adhesive, with glass reinforcement in many cases. Class H temperature rating. Will withstand over 500 F. Corona discharges over 2,500 v will degrade. ET-1 comes unfused; when oven-fused at around 700 F it seals to itself and shrinks tightly around object
Lexel (Dobeckmun Co.); Scotch Brand (Minnesota Mining); Tuck (Technical Tape Corp.)	Noncorrosive acetate tape. Available with thermosetting adhesive, with cloth reinforcement and a variety of other forms for splicing, insulating and other applications. Widely used in electrolytic capacitors, fine wire coils
Tuck (Technical Tape Corp.)	New flatback paper and manufacturing process combine to give dielectric strength of 5,000 v
Bi-Seal (Bishop Mfg. Corp.); Lexel (Dobeckmun Co.)	Self-bonding polyethylene tape. Dielectric strength 1,000 v/mil. Low loss (power factor 0.0006). Withstands —40 F to 175 F. Fuses into solid mass
Scotchcast (Minnesota Mining)	Epoxy-filled tape available with backings of glass cloth or mat, polyester mat, polyester-bonded mica or polyester film. Gives advantages of epoxy resin in tape form for wrapping coils, as cylinder wrap for capacitors and for other applications normally requiring a liquid epoxy resin
Positive Placement Insulation (W. H. Brady Co.)	Die-cut tape, available precut to exact shapes needed, in self-adhesive acetate, vinyl and other tape materials. Easy to dispense and apply, speeding production-line assembly operations
Ben Har (Bentley, Harris Mfg.); Heminway & Bartlett; Polytet (Warren Wire Co.); Teflace (Gudebrod Bros.)	Teflon lacing tape for wiring harness applications involving temperatures to 500 F. Does not shrink or become brittle at —100 F. Available in various widths, thicknesses and colors, uncoated or coated for greater surface friction. Tied knots will not loosen. Ben Har and Warren use Teflon coats on glass fibers before braiding
Amplifilm (Aircraft-Marine Prod.)	Bertonite-filled dielectric sheet having high dielectric strength and dielectric constant of 4.3; for high-voltage capacitors for d-c, pulse and audio circuits

to encapsulation, now available from Emerson & Cuming as compound 453B, comes in two parts that are mixed just before use, then applied by dipping.

Protection for electroplated or chemically cleaned metal surfaces is provided by Fidelity Chemical Products Corp.'s Laqua, a new water-dip lacquer that can either be sprayed or applied as a dip.

Adhesion qualities of epoxies are the basis for a general-purpose coating material that will cure at room temperature in about one day. It is furnished in two parts as EP-450 by Electronic Plastics Corp.

New method of applying zinc chromate primer is by means of an aerosol container convenient for touch-up work on bolt, screw and rivet heads. West-line Products Division is one firm providing this packaging. This company also provides similar aerosol packaging for their Splac plastic lacquer spray.

A water-repellent silicone film with good dielectric properties (Dow-Corning F-145) has been developed to protect precision electronic instruments such as are used in geophysical research, and also serves for coating switch boxes and cable connectors. Air drying time is 1 hr with dip, spray or brush applications. Union Carbide Y-1162 silicone water repellent similarly provides an invisible, low-cost water-repellent film that does not interfere with soldering.

**FOR CORES**—Individual laminations of transformers can be given a corrosion-resistant phosphate insulating coating having desirable heat-resisting qualities (Topper Mfg. Co.). For tape-wound toroidal cores, Carstedt Plastics offers Superseal, an economical new coating having good dielectric strength.

**FOR COILS**—Improved varnishes provide required compatibility with new polyester and other plastic insulations for wires. Practically all varnish manufacturers are offering such new varnishes. Examples include Schenectady 99B varnish (Schenectady Varnish Co.) for Isonel, Formvar, silicone and nylon magnet wire and new GE silicone varnishes.

**FOR SHIELDING**—High-adhesion Vorac H520 (Vorac Co.) for cathode-ray tube exteriors gives as low as 25 ohms across width of tube.

**Take advantage of the  
specialized know-how available  
from manufacturers of coatings**

# foam plastics handle a wide range of jobs

*Rigid prefoamed or foamed-in-place plastics offer intriguing new electrical, acoustical and structural properties to the designer of electronic equipment. One of their many virtues is their light weight*

**CELLULOSE ACETATE FOAM**—This rigid foam, available in prefoamed shapes, is produced by an extrusion process having no limitations on length. Maximum cross-section is limited only by the capacity of the extruder, and 6-sq-in forms are already being produced under a du Pont license as CCA (Strux Corp.).

Chief electronic uses are as cores in sandwich construction and for soundproofing where light weight is desirable. Density range is 6 to 8 lb/cu ft. Dielectric constant is 1.12 and loss tangent 0.002.

**EPOXY FOAMS**—Rigid foam-in-place epoxies serve for encapsulation and as core material for double-walled radomes. In one form (Epocast H865 by Furane Plastics), a catalyst is added to an epoxy mix. Internal temperature during foaming ranges from 220 F to 260 F, and densities normally range from about 2 to 25 lb/cu ft. Also available is a single-powder version that requires only heat to produce foaming.

Prefoamed blocks of epoxy foam are available in sizes

up to 1 x 2 x 6 ft in size from DeBell & Richardson as DuRafoam, with densities ranging from 1.5 to 20 lb/cu ft.

**ISOCYANATE FOAMS**—Versatile new isocyanate foams can be produced with a wide variety of electrical and mechanical properties and characteristics. They can be flexible, semirigid or rigid. They can have open or closed cells. Density can range from under 1 to over 30 lb/cu ft. Dielectric constant varies from 1.5 to 5 almost linearly with density. They are also known as urethane or polyurethane foams, and are made by reacting diisocyanates with polyesters and other ingredients in various ratios. All are thermosetting.

Isocyanate foams have excellent electrical insulation and thermal characteristics, coupled with good mechanical strength. Adhesion is good to practically all materials except fluorocarbons and polyethylene. Foams can be produced in place, as for radome cores or for encapsulation, in a few minutes. A 10-lb density is widely used for encapsulation. Metallic inserts should be used to conduct heat outward from tubes and other dissipative components.

One rigid isocyanate example is Eccofoam FP, a liquid resin used with one of seven different catalysts to give foamed bulk densities of 2, 6, 10, 14, 18, 22 or 26 lb/cu ft as desired. Mix for 1 minute, pour into cavity or mold and allow 24 hr for curing at room temperature. At 150 F, curing requires only 1 hr. For production uses, the mold can usually be removed before complete curing. Temperature range is -94 F to 304 F. Manufacturer is Emerson & Cuming.

Addition of metallic flakes to the material gives a new series of high-dielectric-constant foam plastics known as Eccofoam Hi K, available in the same range of sheet sizes as above. Aluminum, silver and various other metals have been successfully used as flakes. Chief applications here are for radome cores and for microwave lenses, waveguides and antennas. Dielectric constant ranges from 1.5 at 10 lb/cu ft to 5.0 at 15 lb/cu ft.

E-P-Fome (Electronic Plastic Corp.) is available in formulations that give semirigid or rigid foams with densities ranging from 2 to 30 lb/cu ft, with room-temperature curing. Molds can be removed in 30 minutes. Dielectric constant is 1.24, power factor at 1,000 cps is 0.003 and volume resistivity is  $10^7$  megohms for E-P-Fome 120.

Method of installing strips of Eccofoam Hi K isocyanate foam in outer glass-fiber laminate shell for aircraft radome. Inner skin is then pressed into place. Technique lightens radome while giving 4.2 dielectric constant



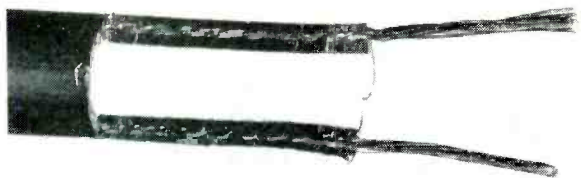

End and cross-section of Belden's Celluline 300-ohm lead-in using Bakelite cellular and solid polyethylene insulation. Closed-cell foam eliminates need for sealing end of cable to keep out water

Scotchfoam A and Scotchfoam 1 (Minn. Mining) are polyisocyanate foams giving densities ranging from 2 to 20 lb/cu ft, currently used chiefly for insulating and filling voids in assemblies. Nopeco Lockfoam is a similar material.

FoamPlast (Topper Mfg. Co.) is available in densities of 5, 10, 15 and 20 lb/cu ft as a closed-cell modified isocyanate foam that starts foaming in 1 minute after mixing and achieves maximum volume in 15 minutes. It may be applied by dip, spray, brush or pouring.

IPI-Isofoam (Isocyanate Products) is another polyisocyanate-and-catalyst formulation, giving densities of 2 to 20 lb/cu ft either when poured into a mold or sprayed on a surface. The resulting foam can be handled normally in 2 to 3 hr with air drying and will have almost 90 per cent of its maximum strength in 24 hr. For spraying a dual spray gun is used. Spraying can be done at the rate of 3 board feet per minute. A  $\frac{1}{8}$  to  $\frac{1}{4}$ -inch layer or mix on a surface will expand to give about 1 inch of tough-skinned foam. At a density of 2 lb/cu ft, the 1,000-cps dielectric constant is 1.42 and the power factor is 0.003.

**PHENOLIC FOAMS**—These are rigid foamed-in-place materials having both open and closed cells, hence both acoustical and thermal insulating properties are good. Maximum continuous operating temperature is about 300 F. The available density range is wide, from  $\frac{1}{2}$  to over 25 lb/cu ft. Transmission loss averages 17.3 over the range of 200 to 3,500 cps.

Phenolics are foamed in place by adding an accelerator to a liquid phenolic resin, mixing for not more than 30 sec, then pouring into a mold. The entire foaming process can be completed in as little as 2 minutes without external heat or pressure.

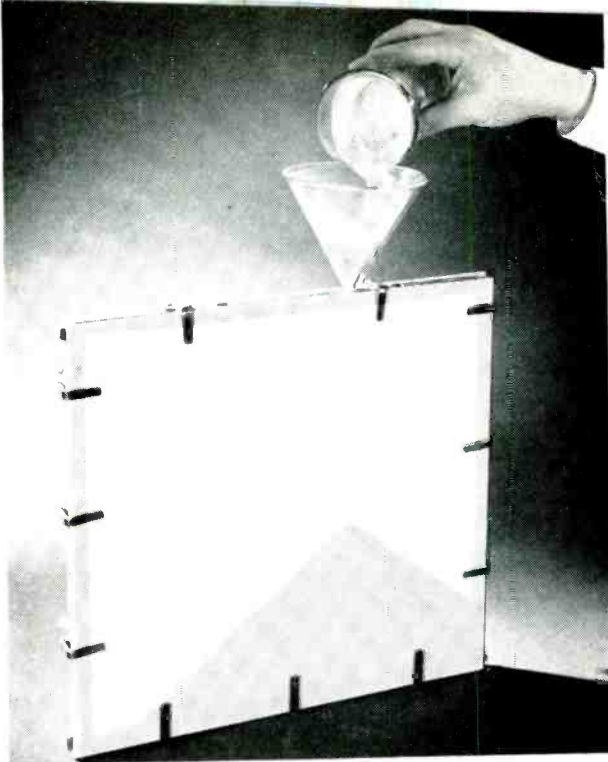

Outward pressure of silicone foaming powder is so small that sandwich panels require no metal side plates during foaming. Only heat is needed to expand this Dow-Corning product

A phenolic-epoxy powder (Eccofoam GL) for encapsulation and for double-walled radome cores is poured to fill a cavity or mold completely. Upon heating to 250 F for 1 hr or 200 F for 2 hr, it cures to a rigid foam and will then withstand up to 350 F. Loose packing during filling boosts density to 22 lb/cu ft. Dielectric constant at 10,000 mc is 1.48 and dissipation factor is 0.009.

**POLYETHYLENE FOAMS**—Cellular polyethylene is a better insulator than its solid version, and is lighter in weight. Chief use at present appears to be for insulating wires and particularly for filling coaxial cables and tubular television twin-lead wire. Bakelite's version shows a dielectric constant of 1.49 and a power factor of 0.00038 for the cellular form at 10,000 cps, as compared to 2.3 and 0.0003 respectively for the solid material.

**POLYSTYRENE FOAMS**—Here is a foam that is always rigid, has closed cells for water-tightness and buoyancy, has good electrical properties and low loss. Both prefoamed and foamed-in-place types are available. The material is inherently flammable, but can be treated to improve flame resistance so it will melt without bursting into flame. Chief applications are for microwave lenses, waveguides and antennas.

Eccofoam PS is a prefoamed polystyrene of adjusted dielectric constant available in standard 18 x 24-inch sheets 3 inches thick, with dielectric constants within 0.02 of the following values: 1.1, 1.2, 1.3, 1.4, 1.5, 1.6, 1.7, 1.8, 1.9 and 2.0. Dissipation factor is 0.0004. Electrical characteristics are independent of frequency. Recommended maximum temperature and bulk density

## REPRESENTATIVE MICROWAVE-ABSORBING MATERIALS

(All meet Navy specifications of 2% maximum power reflection)

Trade Name & Manufacturer	Material	Thickness inches	Weight lb/sq ft	Frequency Range mc	Maximum Power Absorption w/sq in.	Temperature Range deg F	Comments
Eccosorb FR (Emerson & Cuming)	Rigid polystyrene foam sheet treated with carbon-black and metal dispersion	2	0.63	2,300	2	-94 to 180	Walls of free-space rooms. Will withstand outdoor weathering. Supplied in 1' x 3' sheets. Self-extinguishing after flame. Cement to flat surfaces, impale on pins or tie to furring. For floors use FR-4, which has a rugged laminate facing and compressive strength of 5,000 lb/sq ft with microwave-absorption characteristics
		4	1.25	940	2	-94 to 180	
		8	2.5	455	2	-94 to 180	
Eccosorb AN	Flexible isocyanate foam sheet with carbon-black and metal incorporated in foam	1/8	0.04	20,000	3	-94 to 302	Lining antenna nacelles and enclosures. Oil resistant. Self-extinguishing after flame. Can be draped over objects or cemented to surfaces. Relatively insensitive to incident angle. Easily cut with scissors and formed to curves
		3/8	0.11	7,500	3	-94 to 302	
		5/8	0.17	3,500	3	-94 to 302	
		7/8	0.25	2,400	3	-94 to 302	
Eccosorb CH	Rigid 2' square sheets of rubberized and emeshed animal fibers with carbon-black dispersed in neoprene	2	0.61	2,300	1.5	-94 to 180	Broadband absorber for microwave dark rooms. Sheets are 2' square. Mount by tying to furring with waxed twine or impaling on small hooks or pins. For much of useful frequency range reflected energy is well below 1% for normal incidence
		4	1.0	940	1.5	-94 to 180	
		8	1.75	455	1.5	-94 to 180	
Eccosorb CHW	Same material as CH, supplied as two wedges mounted on 2' square hardboard. (Next column gives wedge lengths in inches)	(15)	5.75	200	3	-94 to 180	Extends lower frequency limit of base material down into vhf region for broadband anechoic chambers. Hardboard panels are mounted to floor, wall and ceiling with plastic bolts. Working floor, transparent to radiated energy, can be constructed above floor wedges
		(28)	3.5	100	3	-94 to 180	
		(54)	2.5	50	3	-94 to 180	
Spongex (B. F. Goodrich Sponge Prod. Div.)	Curled animal hair in 2' square sheets, rubberized with conducting carbon-black in neoprene	1/2	0.275	10,000	—	—	Lightweight, flexible, easily mounted material for anechoic chambers. The two thinner sheets may be cemented in position and all may be tied in position with waxed twine. Self-extinguishing after flame. Weatherproof
		1	0.313	5,000	—	—	
		2	0.45	2,400	1	—	
		4	0.5	1,000	1	—	
Spongex	Glass fiber in 2' square sheets, rubberized with conducting carbon-black in neoprene	3/4	0.2	5,000	—	up to 400	For lining walls of indoor antenna and radome test ranges. High power absorption at ambient temperatures up to 400 F. Will not burn. Expect to bring out other thicknesses to broaden frequency range, as well as prism-type structure 30" high for frequency range from 100 mc up
McMillan BL (McMillan Industrial Corp.)	Rigid 1' x 4' plastic foam sheets	2 1/8	1.5	2,400	2	-62 to 155	Walls, ceiling and test panels. Rear surface is Masonite-backed for mechanical or adhesive mounting. Washable. Can be painted. Will soon have other sheets, covering range of 50 to 35,000 mc
McMillan BH	Rigid 1' x 4' plastic foam sheets	2 1/8	1.8	2,400	2	-62 to 175	For floors and outdoor applications. Compressive strength 18,000 lb/sq ft. Unaffected by weather and high humidity outdoors because of closed cell structure. Rubber-base or latex type paint recommended outdoors
McMillan H	Rigid 2' square hair sheets	1	0.5	5,400	1	-65 to 122	For indoor temporary or portable microwave test ranges. Light in weight (0.5 to 1.9 lb/sq ft). For use in air-conditioned areas or where relative humidity is below 60%. Also available in 48" pyramids for 100-mc use
		2	0.65	2,500	1	-65 to 122	
		4	0.94	1,000	1	-65 to 122	
		8	1.9	500	1	-65 to 122	
McMillan T	Thin flexible 18" x 36" plastic foam sheets	3/16	0.3	9,375	2	-62 to 172	For airborne applications where space and weight are critical. Easily formed around aircraft bulkheads and antenna reflectors. Unaffected by oils and moisture. Can be mounted with Pliobond M-20 or Cycleweld C-14 adhesives
		1/4	0.36	5,400	2	-62 to 172	

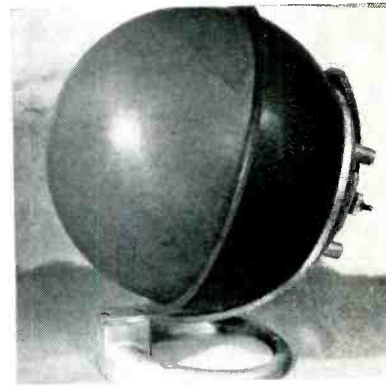
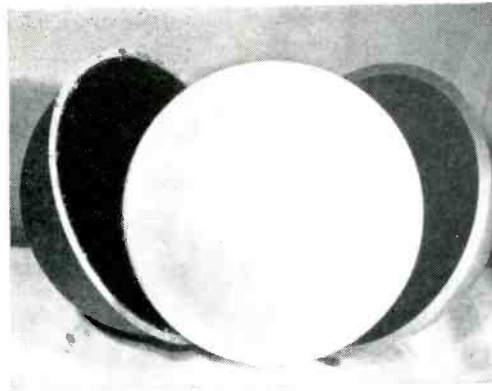
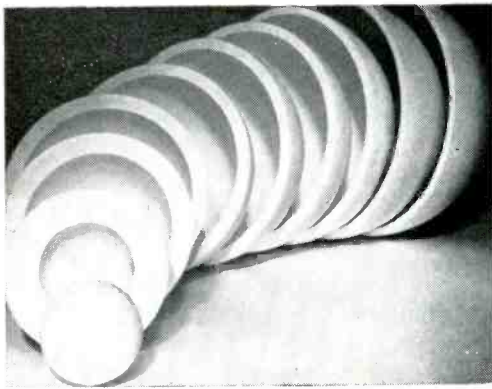

FIRST PAGE: Shown here and on the front cover of this report are spherical half-shells of Eccofoam PS foam polystyrene that are set into protective half-shells one of which has metallized inside surface, then mounted for use as Luneberg lens type of passive radar target or beacon. Other Emerson & Cuming materials also on cover include foam and rubberized horsehair microwave absorbers, rod and sheet foams of solid and foam plastics, metal-loaded foam and liquid casting resins

both vary with dielectric constant: for  $K = 1.2$ , density is 12 lb/cu ft and the limit is 140 F; for  $K = 1.6$  the figures are 29 and 167 F; for  $K = 2.0$  density goes up to 49 and the limit is 185 F. The material can also be factory-molded to exact shapes and sizes.

Dylite foam-in-place polystyrene (Koppers Co.) comes as transparent or colored beads that can be poured into a mold. Heat causes the beads to expand and fuse together into a foam having discrete closed cells. Density is controlled over a range of 1.5 to 15 lb/cu ft by varying the amount of beads charged into the mold. This process makes it feasible for small manufacturers to produce foam shapes economically by molding or extrusion.

Electrical properties of Dylite make it useful for high-frequency insulation, particularly around antennas. Dissipation and loss factors are both under 0.0006. Surface resistivity is about 10 megohms per square and volume resistivity is greater than 15 megohm-inches. Dielectric strength is 48 v/mil. Dielectric constant ranges from 1.24 at 60 cps to 1.05 at 1 mc, even after 96 hr at 95 F and 96 percent relative humidity.

Styrofoam prefoamed polystyrene (Dow Chemical Co.) comes in various sheet sizes and thicknesses in a density range of 1.3 to 2.0 lb/cu ft. Dielectric constant is around 1.0 and power factor is below 0.002 over a frequency range of 100 cps to 100 mc. Temperature limit for continuous operation is 175 F. An expandable bead form will foam in place when heated by 400 F air.

**SILICONE FOAMS**—For good thermal and electrical properties at high temperatures, this is a foam material to be considered. It is a rigid material available either for foaming in place or as prefoamed blocks and sheets. The heat distortion point is over 370 F and it will withstand continuous temperatures somewhat above this value. On direct exposure to flame it becomes red-hot but does not burn and shows only slight surface change.

Although originally silicone foams required mixing with catalysts and blowing agents, three powders now available from Dow-Corning require only heat to expand into foam. The powder is charged into a suitable

mold and heat is applied with heat lamps, air circulating ovens or strip heaters to produce foaming. To prevent shrinkage in the mold, the heat should be maintained for an additional 4 hr after foaming. For maximum mechanical strength at elevated temperatures, a further cure of about 48 hr at 250 C is recommended.

Density range for the three powders is 12 to 16 lb/cu ft. Expansion temperature for all is 320 F, and heat distortion temperature is over 700 F. The dielectric constant at 100,000 cps ranges from 1.23 to 1.26, and the power factor at the same frequency ranges from 0.0004 to 0.00105. Thermal conductivity is so low (0.3 Btu/hr/sq ft/F/in) that a slab can be touched with the fingers on one side, while the other side is being heated cherry red.

**MICROWAVE ABSORBERS**—When properly treated, certain foam and equivalent fiber materials will absorb 98 percent or more of the radar or other microwave energy reaching them. These materials are therefore often used for construction of microwave free-space rooms that eliminate need for going up on the roof of a plant to test new equipment. Other uses include lining of antenna nacelles and aircraft radome bulkheads.

Absorbers are usually sold as prefoamed or pre-fabricated sheets, since dielectric constant, void size and loss factors must be carefully controlled to get the desired absorption over the desired frequency band. The wider the bandwidth required, the heavier and more expensive becomes the material.

The dielectric constant of a foam-type epoxy encapsulating material can be decreased by filling the material with hollow phenolic spheres of minute size, (Bakelite Corp.) or with similar ceramic spheres.

When airborne pounds  
penalize, foam plastics  
may provide the answer

# glass is an old reliable with many new twists

*Electronic uses for glass continue to increase as new forms and formulations are developed. Concurrently, basic envelope glasses for tubes have been given improved characteristics to permit easier fabrication at higher production speeds and give greater reliability in use*

**SEALING GLASSES**—The increase in the use of hermetic seals for high-altitude airborne electronic equipment has stimulated the development of glasses that will seal to ceramics, mica and silica, as well as to metals and to other glasses. Thus, Corning 7570 will seal to mica.

Soft-sealing or solder glasses are a recent development for use where sealing to metals must be done at lower temperatures to prevent heat distortion or to protect delicate components. The solder glass is usually preglazed on the edges to be joined, much like tinning. Heat is then applied to produce the joint or to take it apart later if necessary.

**PURE SILICA GLASS**—Although a 96 percent silica has long been available, Corning recently announced a practically pure fused silica. In the visible and ultraviolet regions, this is almost perfectly transparent. It has such high stability under radiation that it can withstand 2,000,000-volt electron radiation without discoloration and breakdown. For gamma rays, it takes over  $1.4 \times 10^{10}$  roentgens exposure to produce even a slight bluish tint.

Fields of application include solid delay lines, ultraviolet instrumentation, electrical insulation (particularly at high temperature and high frequency) and high-purity crucibles for growing silicon crystals. Low acoustic attenuation at megacycle frequencies permits use in ultrasonic delay lines for MTI radar.

**CONDUCTIVE GLASS**—Resistivity of conductive coatings on glass can now be controlled economically during continuous production processing to give a resistivity range of 10 to 100 ohms per square. For example, the Corning process known as E-C coating involves applying a metallic oxide to the glass surface at elevated temperatures. The resulting glass can be used in precision resistors, d-c and high-frequency power resistors and in tv and radio resistors. It can be applied in segmented patterns on glass disks for precision potentiometers because its high resistance to abrasion permits direct contact with metal wipers.

Vacuum-metallized quartz fibers for instrument springs or suspensions are available from Servo-Recording Instruments in diameters of from 2 to 30 microns. The fiber can be stretched, and 5-micron fibers can be twisted many times before failure.

Plate glass having a transparent conducting coating, now available from Pittsburgh Plate Glass Co. as Nesa glass, is used for heating instrument windows to prevent fogging or icing, to dissipate static charges and to provide moderate electrostatic shielding. It is also suited for use in electroluminescent lighting panels and certain kinds of light amplifiers.

**NONBROWNING FACE GLASS**—Plate glass 3459 (Pittsburgh) for flat and convex face plates in high-voltage cathode-ray tubes and flying-spot scanners withstands high-voltage electric bombardment and associated x-rays for 1,000 hr without appreciable loss in light transmission.

**CHROME-IRON SEALING GLASS**—Many 21-inch round color television picture tubes have a precision-bent face plate of Pittsburgh 5533 Teleglas. This glass fuses directly to the 430 alloy metal envelope. In addition to being nonbrowning and x-ray absorbing, it has been given a light gray color (77 percent light transmission) to enhance picture contrast.

**MILD STEEL SEALING GLASS**—A new face plate glass (Pittsburgh 7210) that will seal directly to ordinary cold-rolled steel is in an advanced stage of development.

**TV IMPLOSION WINDOWS**—Implosion windows were originally designed merely to protect the viewer from the picture tube and to protect the tube from the viewer. However, the wide-spread use of aluminized picture tubes in recent years has enabled the window to assume a new additional function. Teleglas 3720-3, used either as tempered safety glass or laminated safety glass and having a neutral light transmission of 55 percent, provides high picture contrast even under extremely bright ambient lighting.

**GLASS FILM**—Ribbons of lead silicate glass about 0.001 inch thick, having good electrical properties, are now being produced as Corning 8871. Chief use at present is for glass-dielectric capacitors. These are as-

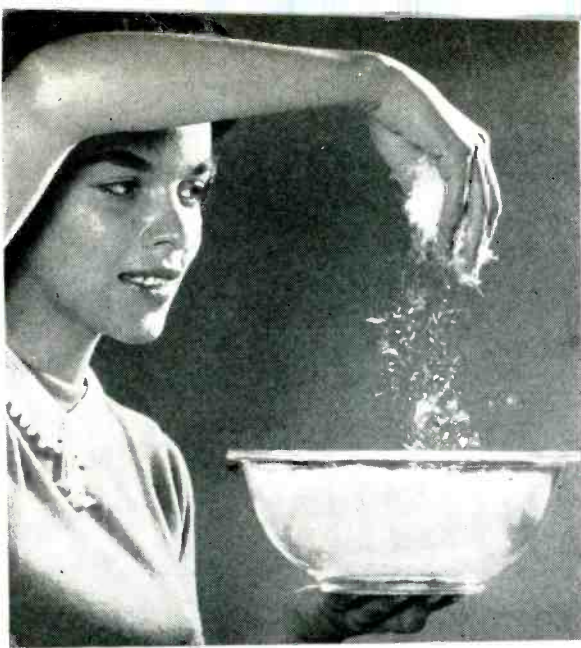

Newly developed Owens-Corning Flakeglas improves electrical and physical properties of casting resins when used as filler; individual flakes are thin enough to float in air

Examples of metallized glass components for electronic applications, using various types of Corning glasses

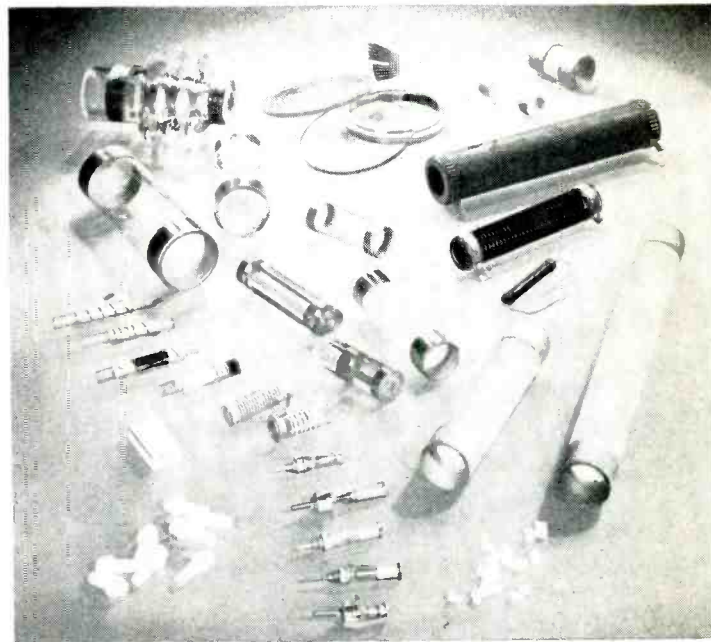

sembled in much the same manner as mica capacitors, covered with glass, then fused into a single homogeneous unit. Though flexible enough to be wound around a one-inch rod, this glass film cannot as yet be bent to accommodate the smaller diameters of the paper-type capacitors.

**GLASS COATING**—Ceramic capacitors are being dipped in molten glass by Glenco Corp. to give a moisture-proof coating that will withstand up to 255 F. The glass fuses with the ceramic. Matched thermal expansions of glass and ceramic give resistance to sudden temperature changes. Operating temperature is then limited by the ceramic dielectric characteristics.

**PHOTOSENSITIVE GLASS**—Exposure of Corning Fotoform glass to ultraviolet light and a heating cycle produces a three-dimensional photographic image in this otherwise clear silicate glass. Exposed portions will then etch out 15 times as fast as unexposed areas in hydrofluoric acid. This permits production of complex shape and hole patterns with high precision in glass sheets up to 0.25 inch thick.

Experimental applications include relay pusher bars, barrier grids for storage tubes, brush holders for digital converters and photoelectric chopper disks. Electronic circuit boards for high-temperature applications are being made from Fotoform glass.

**GLASS FLAKES**—Glass flakes 0.0002 inch thick (Owens-Corning—Flakeglas), when used 40 percent by weight in polyethylene, raise its heat distortion temperature 100 F, increase stiffness and eliminate stress cracks. Similar temperature benefits are obtained with this new filler in epoxies, phenolics, melamines and polyesters, and break-down voltages are increased.

**OTHER NEW GLASSES** — A new optical glass (Bausch & Lomb) for envelopes or windows of scintillation counter photomultipliers resists up to  $10^6$  roentgens of gamma radiation without turning brown.

The same firm has a silver-activated dosimeter glass that changes its ultraviolet induced fluorescence in proportion to gamma radiation exposure, and a cobalt-activated dosimeter glass whose light absorption changes linearly with radiation up to  $10^7$  roentgens.

**GLASS PAPER**—Extremely fine glass fibers bonded together with polyvinyl acetate for general electrical use, with a silicone resin for class H applications and with phenolic or melamine binders for special purposes, are under development by paper manufacturers. Glass Micro-Fibers developed for this purpose by L.O.F. Glass Fibers Co. are typical of the fibers being used. Advantages include easy impregnation, with consequent improvement in heat aging properties.

For applications requiring a low dielectric constant and temperature resistance up to 2,500 F, a quartz fiber has been brought out by L.O.F. for use in paper. This is available commercially from C. H. Dexter & Sons, Inc., and from Hurlbut Paper Co.

Low cost of glass as well as its electrical and physical characteristics make it a good material in its own right and also a good filler for many other materials

# **laminates** fill the needs of mechanized assembly

*Copper-clad laminates using improved plastic resin binders permit cold punching and give great heat resistance. New cupric oxide coating on copper foil doubles peel strength while permitting up to 30-second dip in 500 F solder.*

**COATED COPPER**—A thin, pure layer of cupric oxide formed on the bonding surface of electrolytic or rolled copper foil for printed circuits improves adhesion by acting as a primer for the subsequent adhesive coating. One process for doing this job was developed by Houghton Labs under Signal Corps contract. Coated copper bonded to XXXP phenolic laminate gives a bond strength of 12 to 15 lb and withstands dip-soldering temperature of 500 F for up to 30 seconds without blistering. This coated copper is available as the HP series of Phenolite P-214B, XXP-209G, XXXP-219C, XXXP-455, XXXP-470 and N-1852 (National Vulcanized Fibre). Maximum bond strength is obtained in this instance with electrolytic copper.

**POSTFORMING LAMINATES**—Some new laminates will soften under heat without blistering or otherwise deteriorating, thereby making it possible to reshape the laminate even after the printed circuit has been applied. Pressures for postforming are relatively low, ranging from 5 to 100 psi even for intricate contours. For postforming, the laminate is heated thoroughly and quickly just below the blistering point, then transferred to a mold for reshaping.

**MOLDABLE LAMINATES**—An uncured epoxy-coated phenolic sheet brought out by Rogers Corp. as RM-2035 permits molding of all required holes concurrently with three-dimensional forming during the curing cycle. With appropriate die design, terminals and other hardware can be inserted and molded integral with the board. Plated circuits can be applied after molding and curing. Beads can be formed around holes and edges to give increased strength. Similar uncured laminates are in pilot-plant production at Plastics & Electronics Corp. using polyester as well as epoxy resins.

Copper or other metal foils can be bonded to one or both sides during molding, using a conventional adhesive coating on the foil or a sheet form of adhesive film.

A laminated combination of plastic and synthetic rubber sheets (Gravoflex—Hermes Plastics Inc.) for instrument panels can be engraved through the black layer to show the permanent white of the backing sheet. The material is easily bent or formed after the lettering has been produced with conventional rotating cutters.

**PRINTED-CIRCUIT PHENOLICS**—XXXP continues to be popular. Improvements remove some of its limitations and broaden its applications.

Cold-punching forms of XXXP now include National Vulcanized Fibre's XXXP-470 Phenolite, Continental-Diamond Fibre's XXXP-28 Dilecto, Taylor Fibre's XXXP-242, Spaulding Fibre's XXXP-730 Spauldite, GE's XXXP-IR Textolite 11570, New England Laminates' Nelco 240, Formica's XXXP-36, and Northern Plastics Corp.'s Norplex XXXP-925, XXXP-926 and XXXP-IR.

In general, these materials are cold-punching up to  $\frac{3}{8}$  in. thick and require warming for greater thicknesses. Cold punching insures high accuracy of register of holes with printed circuits and gives dimensional stability. Electrical and physical properties are practically all the same or better than for basic XXXP. Transparency is a benefit often achieved from the cold-punching formulation; this permits visual checking of register between circuits on opposite sides by holding board up to light.

Examples of new paper phenolics having high insulation resistance include Textolite 11570, Dilecto XXXP-26, Spauldite XXXP 690, Northern Plastics Corp.'s Norplex XXXP-925 and XXXP-914 and Phenolite XXXP-455. Upper temperature limit here is generally 250 F for continuous use. Dielectric constant is 4 to 5, dissipation factor is 0.025 to 0.035 and 24-hour moisture absorption is generally well below 1 percent. Somewhat similar is Dilecto XXX-61, available as roll tubing that remains electrically and dimensionally stable after exposure to high humidity; applications include electronic fuel gages.

Flexible phenolics using glass-cloth reinforcement bring a third dimension to assembled circuits without necessity for postforming in presses. Examples include Photocircuits Corp. Flexfoil, rated for 265 F continuously. Formica Corp.'s FF-21 uses the same phenolic-glass fabric combination for transformer inter-layer insulation good up to 350 F.

Recent additions to lines of general-purpose punching phenolics for sockets and terminal strips include



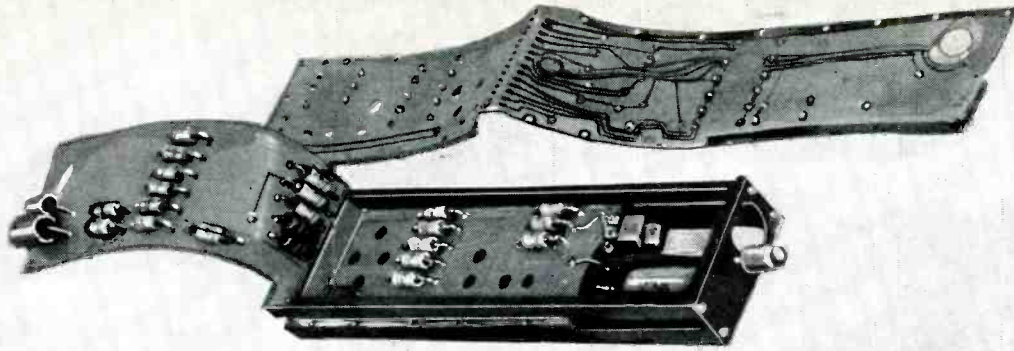

Components assembled on Flexfoil laminate by Photocircuits are arranged to nest together when sheet is folded in half to fit into housing. The copper-clad phenolic-glass cloth material is 0.012 inch thick and will bend to 1/8-inch radius

Dilecto XXP-14FR and XX-13FR that are flame-retardant, self-extinguishing and rated 250 F continuous, Phenolite Y-2500 having arc resistance comparable to the melamines, Dilecto MEC-5 having high fungus resistance along with high insulation resistance at high humidity, Taylor XXP-241 featuring similar high resistance to humidity and Taylor XP-240 having sufficient flexibility to permit cold-punching in thinner sizes.

New punching laminates for tube bases and similar parts, operating continuously to 350 F and intermittently to 435 F, are exemplified by Formica's FF-49 glass-reinforced phenolic.

**PRINTED-CIRCUIT EPOXIES**—Combining different epoxy resin formulations with various forms of glass, synthetic fiber, paper and other filler materials gives a wide choice of characteristics. Examples include glass-base Phenolite G-10-865 having heat resistance to 265 F and insulation resistance of 1,000,000 megohms, glass-base Dilecto GB-181-E having heat resistance to 300 F and 20,000-megohm insulation resistance, and Taylor's glass-base GEC rated at 250 F for 30 minutes and 300,000-megohm insulation resistance. New England Laminates has a Nelco 100 epoxy-glass laminate with 10,000,000 megohms insulation resistance, as well as flame-retardant paper and glass types. Emerson & Cuming has Ecco L 28 glass-cloth epoxide laminates for normal epoxy temperatures and an L 266 high-temperature version good up to 500 F. Many other new epoxy laminates are available from these and other firms, including cold-punching versions.

**PRINTED-CIRCUIT POLYESTERS**—Glass-reinforced polyester laminates are widely used for terminal boards and such mounting applications as socket wafers and flyback transformers. Low moisture absorption eliminates wax-coating operations. Resistance to heat is good and ranges up to 300 F continuous. Examples: American Insulator Corp. Alco 200, 201 and 202; Emerson & Cuming Ecco L 44; Glastic Corp. UMM and GMM; National Vulcanized Fibre GP-9100, GP-9104 and GP-9202.

**PRINTED-CIRCUIT FLUOROCARBONS**—New techniques give high copper-clad bond strengths when using materials such as solid or glass-reinforced Teflon

or Kel-F as the laminate. Blister temperature is over 500 F. Good electrical qualities, heat resistance and dimensional stability are obtained. Dilecto GB-116T, as a typical example of glass-cloth reinforcement in Teflon, is rated 400 F continuous, has a dissipation factor of 0.0006 and has a dielectric constant of 2.85 at 1 mc. IRC's copper-clad polymonochlorotrifluoroethylene has similar properties and is somewhat flexible in thin sections. Research on similar laminates is under way at other laboratories.

### **PRINTED-CIRCUIT STYRENE COPOLYMERS**

—Glass fiber reinforcement gives good machinability, good punching properties and high impact strength to products like REX Corp.'s Rexolite 2200 and Emerson & Cuming's Stycast 0005 as uhf laminates. Dissipation factor ranges from 0.0004 at 1 mc to 0.0010 at 10,000 mc. Dielectric constant is constant at 2.77 for all frequencies up to 10,000 mc.

**PRINTED-CIRCUIT MICA**—Synthetic mica bonded with molten glass under pressure gives high dimensional stability. Continuous temperature rating of 450 F is limited only by the bonding agent used for the copper wiring.

Chief use for this material is in etched circuits for guided missile and other extreme environmental applications. Examples: Supramica 500 ceramoplastic by Mycalex Corp.

**PRINTED-CIRCUIT SILICONES**—Glass-based silicone laminates are rated class H, being good up to 480 F when not subjected to hydrocarbon oils or solvents. One example is Formica's G-7-2. Resins for these laminates are available from Union Carbide as R-63 and from Dow-Corning.

A plated or etched wiring board is no better than its laminate; there is no longer excuse for blistering in molten solder or peeling in service

# magnetic materials handle more energy in smaller volume

*Core materials now provide higher permeability with lower core losses. Plastic tape for wound cores provides inductance and capacitance as well as magnetic characteristics. Ceramic and plastic permanent magnets simplify production of complex shapes*

**HIGH-PERMEABILITY CORES**—A magnetic flake core material, Flakenol I, developed by the Naval Ordnance Laboratory, has a maximum permeability range from 180 to 230. The core uses non-strategic iron, silicon and aluminum. Flakenol I provides high permeability with low losses. The material is suitable for applications in filter networks, resonant circuits and transformers. It is corrosion-resistant and has a low density.

Laboratory samples of Flakenol show initial permeabilities on the order of 230 with hysteresis and eddy current losses of  $8.2 \times 10^6$  and  $3.5 \times 10^9$  respectively.

Improved manufacturing techniques have increased the magnetic characteristics of Alfenol. Two nominal compositions of 12 and 16 percent aluminum content have interesting characteristics for electronic applications.

The 12-Alfenol is useful in low-power transducers, particularly at higher frequencies, and improves its magnetic properties as temperature is decreased.

Tape-recorder recording heads and synchro-motors are among the applications. Type 16 exhibits its best properties at room temperature, and is suited to tape recorder playback heads, resolvers and transformer applications.

Thermenol, another high-permeability magnetic material developed by Naval Ordnance, is an iron-aluminum-molybdenum composition. A resistivity of 162  $\mu$ ohms/cm reduces eddy current losses and, combined with a low coercive force, provides a low hysteresis loss. High permeability and low coercive force are obtained with rapid cooling during processing. Slowly cooled material has low permeability, high coercive force and higher saturation.

High aluminum content makes Thermenol light. Hardness is 310 Brinell. This hardness makes the material suitable for tape-recorder heads and other

applications where abrasion is encountered. Thermenol has high corrosion resistance to oxidizing acids, bases and salt water. A film of oxide that forms on it during processing provides a natural electrical insulation between layers when laminated.

A new GE core material called Dynamax has in experimental work shown a maximum permeability of 1,780,000, residual flux density of 11,950 gauss and a coercive force of 0.0053 oersteds. The hysteresis loop at 60 and 400 cps is narrow and temperature effect on magnetic characteristics is small.

The new alloy consists of 65-percent nickel, 2-percent molybdenum and the remainder iron. Annealing in a magnetic field is necessary to obtain maximum magnetic values. Applications of this material include high-gain magnetic amplifiers and special transformers.

Transformer cores for operation at ambient temperatures as high as 960 F have been developed by GE. Magnetic steels with Curie temperatures above 930 F are used with silver-nickel clad conductors and ceramic insulations.

**CHARACTERISTICS OF TYPICAL CORE MATERIALS**

Name	Initial Permeability	Maximum Permeability	Saturation In Gauss
12-Alfenol (7, 8)	780-4,500	2,000-45,000	11,100-14,400
16-Alfenol (7, 8)	600-4,127	4,000-95,000	5,500-7,800
Thermenol (5)	847-7,750	7,000-130,000	5,600-8,500
<b>High-Permeability Nickel-Irons:</b>			
Hy Mu 80 (4, 8)	20,000-22,000	72,000-90,000	8,000-9,000
4-79 Permalloy (1)			
Mo-Permalloy (3)	20,000-40,000	700,000	16,000
48 Alloy (8)			
Carpenter 49 (4)	120,000	900,000	8,000
Allegheny 4750 (1)			
Supermalloy (3)			
<b>Square-Loop:</b>			
Orthonol (8)	500	217,000	15,500
Orthonik (2)			
Deltamax (3)			
Dynamax (6)		1,780,000	12,640

Representative manufacturers: 1. Allegheny Ludlum Steel Corp.; 2. Armco Steel Corp.; 3. Arnold Eng. Co.; 4. Carpenter Steel Co.; 5. Duraloy Co.; 6. General Electric; 7. Hamilton Watch Co.; 8. Magnetics, Inc.



Wound cores for toroids and filters made by Magnetics, Inc. show wide range of sizes used. Smaller cores are wound on ceramic bobbins

**PLASTIC CORE MATERIALS**—A ferromagnetic plastic in the form of rod or tape has been introduced by The Polymer Corp. It is available in flexible and rigid forms. Ferrotron flexible magnet tape has been used in delay-line construction as a combined insulation and core material. Other applications are in transformers and as electromagnetic shielding. The flexible form provides both inductance and capacitance characteristics in addition to magnetic. In delay-line construction these qualities can provide considerable delay time per unit length.

The material is temperature-stable to 400 F and moisture-stable at 100 percent humidity. Volume resistivity and Q are both high. Carbonyl SF powdered iron is the magnetic constituent of the plastic.

**RARE-EARTH CORES**—Praseodymium, neodymium, dysprosium and holmium rare-earth metals are under investigation by Horizon Inc. because of their unusual magnetic properties. Small magnetic circuits using these elements would have appropriate characteristics for applications in high-speed computers. One of the companies supplying these materials is Research Chemicals Inc., a subsidiary of Nuclear Corp. of America.

**PLASTIC PERMANENT MAGNETS**—Plastic-bound magnets made by Boermann-Nord Corp. are prepared by mixing powdered Alnico or other magnetic material with a resin and then molding to shape by conventional compression or injection molding techniques. The energy product of the molded magnet is useful in many applications. Molding permits shaping of complex forms with high dimensional tolerances.

**POWDERED PERMANENT MAGNETS**—Extremely fine iron powder provides a high-coercive-force characteristic in a material produced by General Electric Co. Ltd. Cold molding techniques are used in magnet production to reduce distortion and shrinkage in the finished product. The density of the powdered magnet is comparatively low. With 30 percent cobalt added it will give a high energy factor. It is possible to vary the ratio of remanence to coercive force over a wide range.

**CERAMIC PERMANENT MAGNETS**—The high coercive force obtainable from Cromag barium-ferrite permanent-magnet material makes it suitable

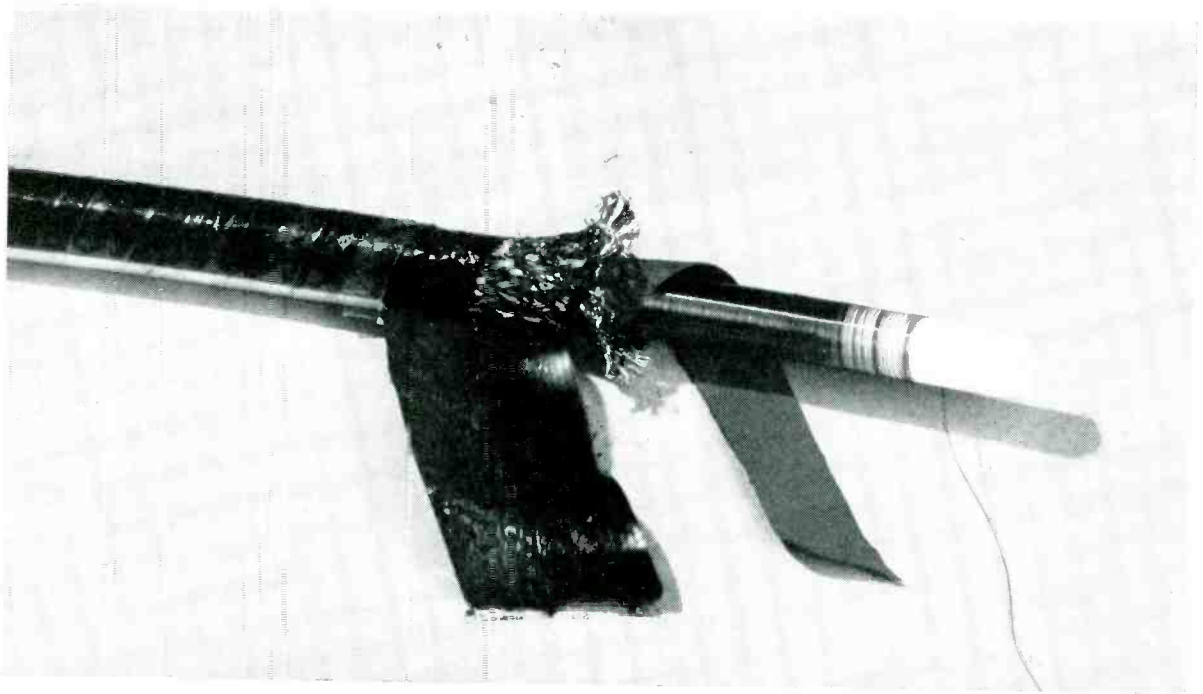

Delay line uses rigid plastic magnetic core and flexible magnetic tape made by Polymer Corp. over wire to provide both inductance and capacitance, thus doubling delay time per unit length. The magnetic tape also serves as insulation

for applications in high demagnetizing fields. Resistivity is  $1 \times 10^9$  ohms and permeability is 1. Magnets of this material manufactured by Henry L. Crowley & Co. have a very short magnetic length and are most suited for large air-gap operation. It is isotropic and stable up to 750 F. Electronic applications include ion traps, beam correctors, loudspeakers and polarized relays.

Ferramic P, a new ferrite permanent magnet made by the General Ceramics Corp., provides high coercive

force with low remanent induction. It is suitable for applications in traveling-wave tubes, polarized relays and high-frequency oscillators.

A ceramic permanent magnet, Indox, made by Indiana Steel Products Co., can be magnetized before or after assembly into a product. It has a coercive force of 1,700 oersted and a maximum energy product of  $0.95 \times 10^6$ . A short magnetic length makes this material useful in loudspeakers, crt focusing units and in sonar applications.

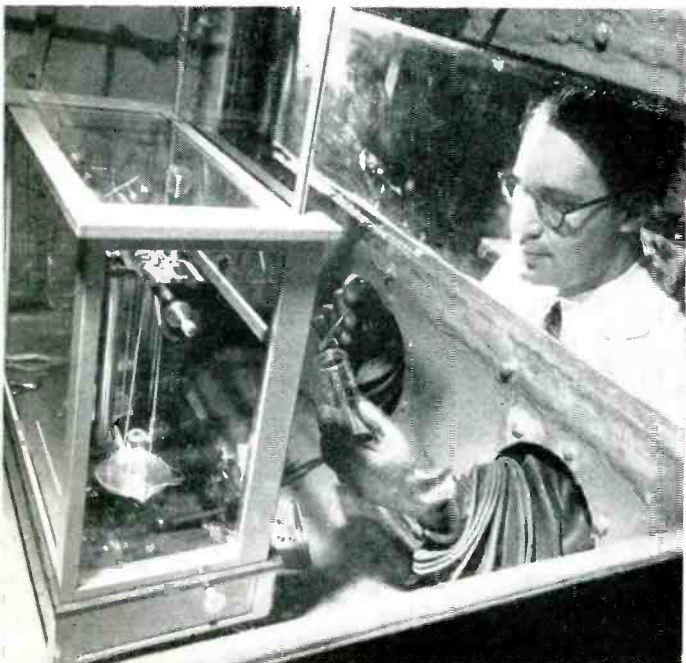

High-coercive-force manganese-bismuth permanent magnets developed at Westinghouse are prepared in inert atmosphere to prevent combustion. Resistance to demagnetization is very high

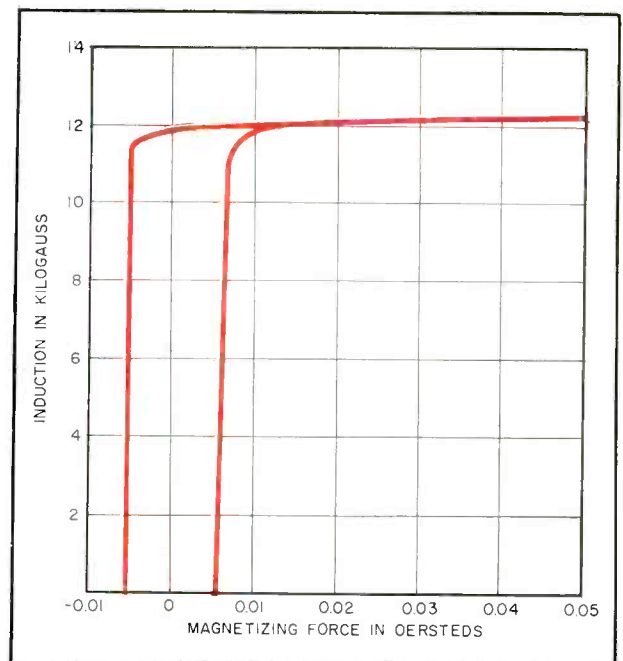

Hysteresis curve of General Electric Dynamax. This sample had a maximum permeability of 1,530,000. Narrow loop makes the material suitable for high-gain magnetic amplifier cores

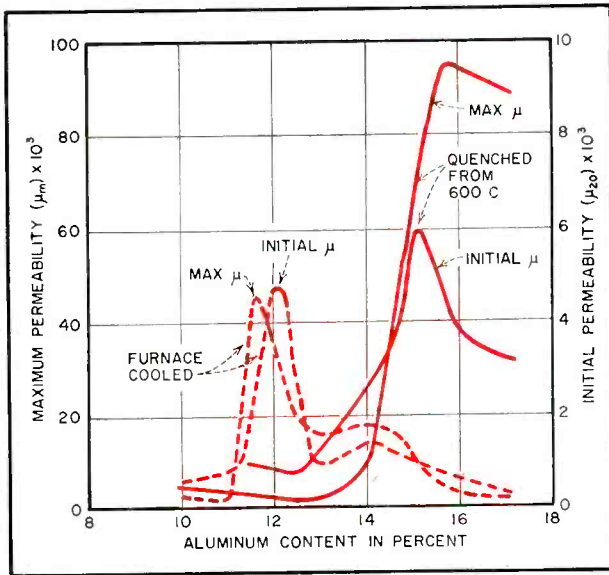

Permeability characteristics of furnace-cooled and quenched Alfenol as a function of aluminum content. Maximum permeabilities are obtained with 12-percent mixture when furnace cooled and with the 16-percent mixture when quenched from 600 C (1,112 F). High permeability of type 16 makes it suitable for tape-recorder head and transformer use

**NICKEL-IRON MAGNETS**—Improvements continue to be made in well-known permanent magnet materials. A new material, Alnico 5Cb, announced by Thomas & Skinner, has a high energy product. Addition of columbium to the Alnico 5 formulation produced the new type with a coercive force of 650 oersted and a residual flux density of 13,300 gauss. Other permanent-magnet materials are listed in the table.

**FERRITES**—Typical rectangular-hysteresis-loop ferrite cores for memory and switching circuit applications are made by General Ceramics Corp. Ferramic S-1 has a saturation flux density of 1,780 gauss and a retentivity of 1,590 gauss. Switching time is about 1 μsec. Another square-loop ferrite is Ferramic S-3, which has a saturation flux density of 2,000 gauss and retentivity of 1,920. Switching time for this ferrite is 4 to 5 μsec.

A nickel-zinc ferrite for lumped inductances, variable inductances and loading coils up to 8 mc is Ferramic Q. It has high Q, low power loss up to 8 mc and an initial permeability of 125.

**MICROWAVE FERRITES**—Typical ferrites for load isolators and gyrators operating at high temperatures are made by Raytheon Mfg. Co. Type R-22 has a Curie temperature of 1,094 F. Saturation flux density is 1,700 gauss and residual magnetization is 1,400 gauss. Type TL-20 has a lower Curie point, 420 F. Saturation flux density is 1,600 gauss and residual magnetization is 1,300 gauss. For a rod 0.25 in. in diameter Faraday rotation is 215 degrees per inch at 10 kmc. Maximum insertion loss at this frequency is 0.2 db per inch.

## REPRESENTATIVE PERMANENT-MAGNET MATERIALS

Name	Coercive Force In Oersteds	Residual Flux Density in Gauss	Max Energy Product	
Alnico 1 (1, 3, 4, 5, 6, 7)	400	7,100	1.3x10 <sup>6</sup>	General-purpose grade
Alnico 4 (1, 3, 4, 5, 6, 7)	700	7,100	1.2x10 <sup>6</sup>	High coercive force, low cost
Alnico 5 (1, 3, 4, 5, 6, 7)	575	12,000	4.5x10 <sup>6</sup>	High energy product
Alnico 5Cb (7)	650	13,300	5.7x10 <sup>6</sup>	High energy-product Alnico 5 with columbium added
Alnico 12 (1, 3, 4, 5, 6, 7)	950	5,800	1.5x10 <sup>6</sup>	Highest coercive force of Alnicos
Cunico (4, 6)	660	3,400	0.8x10 <sup>6</sup>	High coercive force, easily worked
Indox (6)	1,700	2,100	0.95x10 <sup>6</sup>	Ceramic material
Cromag (2)	1,550	2,000	0.8x10 <sup>6</sup>	Barium ferrite ceramic material

Representative manufacturers: 1. Arnold Engineering Co.; 2. Henry L. Crowley & Co.; 3. Crucible Steel Co.; 4. General Electric Co.; 5. General Magnetic Co.; 6. Indiana Steel Products Co.; 7. Thomas & Skinner Steel Prod. Corp.

**FERRITE SHIELDING**—A new shielding material combining high and low-intensity magnetostatic and electromagnetic shielding is being produced by Magnetic Shield Division of Perfection Mica Co. The material consists of a coating of ferrite powder on a magnetic base material, with a protective copper coating to give added abrasion resistance and additional electrostatic shielding.

The ferrite powder is applied to the base metal with Buna-S binder for low-temperature applications and silicone binder for high temperatures. By selection of ferrite powders and particle size, attenuation can be controlled over a range from d-c to 200 mc. In addition to providing low-intensity attenuation, the ferrite powder aids in preventing the base material from becoming retentive, reduces circulating currents and raises the saturation point.

Applications for this type of shielding include color tv picture tubes, multiplier phototubes, magnetron magnets and other equipments requiring a high degree of shielding or shielding at a particular frequency.

Can new magnetic materials increase efficiency and reduce bulk in your components?

# metals and chemicals in new forms cut assembly costs

*New cladding and bonding techniques provide materials having the most desirable characteristics of two metals. Alloys retain their characteristics under more severe operating conditions. Chemical developments promise better transistors, insulators and wire strippers*

**CLAD METALS**—Modern techniques permit bonding of most combinations of malleable metals. These metals are now available in thicknesses down to 0.001 in. with cladding 0.00005 in. thick from specialty metal suppliers such as General Plate Division of Metals & Controls Corp., Sylvania Electric Prod., American Silver Co. and D. E. Makepeace Co. Many combinations are useful to the electronic engineer.

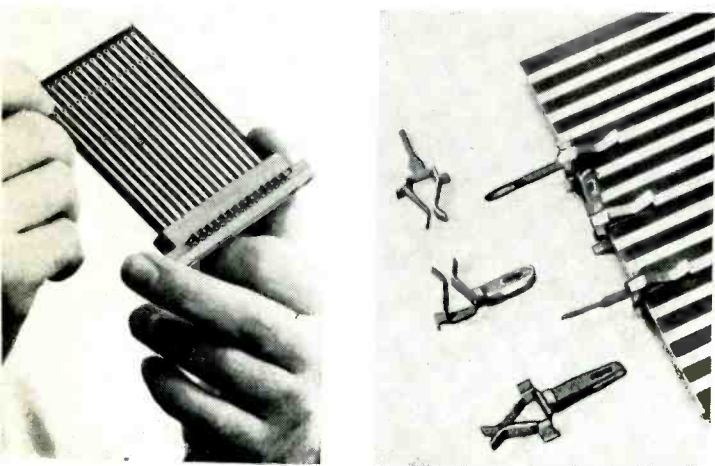

Beryllium-copper contactors made by Berylco for printed-circuit boards combine long fatigue resistance with good electrical conductivity

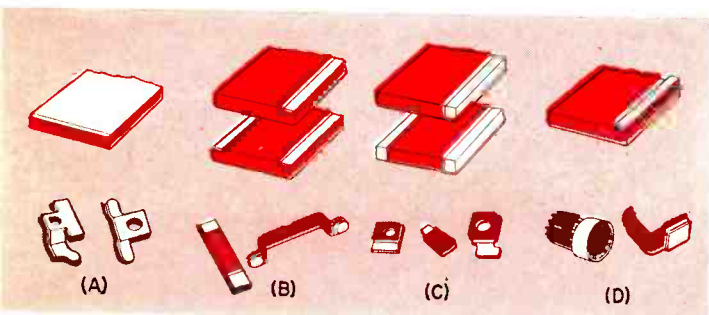

Types of laminated metal stock available from General Plate Division of Metals and Controls Corp. include overlay (A), single and double inlay (B), single and double edgelay (C) and raised lay (D)

Laminated metal stock, consisting of a precious metal bonded to a base stock, is coming into wider use in manufacture of contactors. Typical metal combinations made by D. E. Makepeace Co. and American Silver Co. are silver on phosphor bronze, silver on copper, and palladium-silver on 10 percent nickel-silver. Spot-lay stock, having spots of precious metal at required points on base-metal surface, can be obtained ready for stamping. High-frequency, high-temperature electron-tube operation is facilitated with platinum-clad tungsten grid wire. The tungsten center provides a rigid core at high power and high temperature. Interaction of the tungsten with the platinum coating is low. Platinum-clad wire made by Baker & Co. is clad with 25 to 40 percent platinum by weight over a broad range of diameters.

**CAPACITOR FOIL**—Silicone coating on aluminum capacitor foil provides good power factor with small windings; silicone-coated foil is self-lubricating and can therefore be wound more tightly. Silwynd foil, 0.0002 in. thick, made by Republic Foil & Metal Mills, could, for example, be used in place of a dry foil 0.00017 in. thick.

**THIN COPPER STRIP**—Copper strip 0.00025 in. thick, now being made by American Silver Co., is useful in miniaturized transformers and other components. The strip can be used to make tape-wound wafer-type coils sliced from a copper roll. By stacking the coils with proper interconnections any number of turns can be obtained. A copper foil for printed circuits coated on one or both sides with solder is available from the Delta Co. One side can be made with a thermosetting adhesive coating, for bonding to printed circuit boards, and the other with solder coating.

**SPRING MATERIALS**—High strength and long life are features of alloys now available for plug and printed-circuit connectors, switch and relay contacts, vibration mounts and mounting clips for subminiature tubes. Examples include beryllium copper (Beryllium Corp., Instrument Specialties Corp., Penn Precision Products, Superior Tube Co.), high-cobalt alloy (Wilbur B. Driver Co.) and cobalt-chrome alloy (Elgin National Watch Co.).

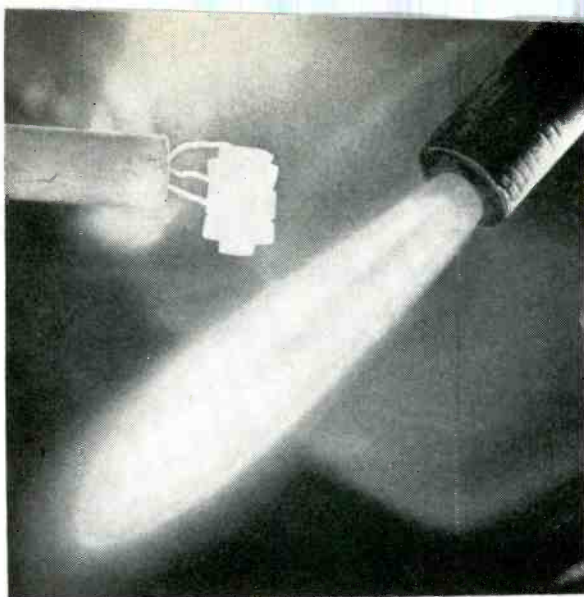

Tube constructed of titanium metal and special forsterite ceramic by GE operates at ambient temperatures up to 1,450 F. Heaterless cathode provides emission at operating temperatures above 660 F



Wire-stripping tank uses Lonco chemical stripper to remove insulation. Ends of leads are suspended in liquid for one revolution around doughnut-shaped pan filled with stripping chemical

**SHIELDING**—R-f interference reduction and heat-conductive shields for tubes are among the applications for knitted metallic cloth. A cloth manufactured by Metal Textiles Corp. is available in Monel, aluminum or silver-plated brass to meet various requirements.

For tube shielding, knitted tubing of aluminum wire is used. The tubing fits tightly over the envelope. The elasticity of the mesh provides a tight fit around the tube envelope for good conductivity.

**SEMICONDUCTOR ALLOYS**—High purity silicon and germanium raw materials for transistors and rectifiers are now available from companies such as Du Pont, Sylvania, Semimetals Inc. and Societe de la Vieille Montagne, Belgium.

Semiconductor doping alloys made by Alpha Metals, Inc. are supplied in disks, spheres and other shapes for producing collector or emitter dots in diodes and transistors.

**INTERMETALLIC SEMICONDUCTORS**—A wide range of electrical properties are obtainable in intermetallic compounds now under investigation by Bell Telephone Laboratories and others.

Most thoroughly investigated so far has been indium antimony. Although energy gap of 0.17 electron volts is low, the high electron mobility of 70,000 cm<sup>2</sup>/volt sec makes it of interest.

Indium antimonide supplied by Ohio Semiconductors has high electron mobility. It is also highly sensitive to infrared radiation. Possible circuit applications for this new material are as a nonmechanical d-c to a-c converter, rectifier, transducer, current modulator or as a voltage and current regulator.

**LIQUID AND GAS DIELECTRICS**—Silicone dielectric fluids and dimethyl silicone oil made by Dow Chemical Co. are high-flashpoint liquids for capacitor and transformer dielectric applications. The dielectric fluid shows little change in dielectric constant over a wide range of temperatures and frequencies and has

good heat transfer characteristics. Dielectric constants vary in a range from 2.18 to 2.77 at 1,000 cps. The silicone oil has a dielectric strength of 35 to 40 kv. Dielectric constant is less than 2.8.

A synthetic polymer liquid, Polybutene 32 made by Oronite Chemical Co., has high dielectric strength, low power factor and low coefficient of thermal expansion. Power factor ranges from 0.03 to 0.08 at 1,000 cps and 10 mc respectively.

Sulfur Hexafluide gas dielectric, such as that produced by Baker and Adamson, provides high dielectric strength. Good dielectric strength is retained at temperature as low as -90 F.

**WIRE-STRIPPING CHEMICALS** — Wire-stripping cream 504 by Ellanar Chemical Co. permits stripping in the middle of a coil without creeping or shorting of turns. Examples of other improved liquid strippers for various types of insulation include:

Alkanex—Lonco GN-LR (London Chemical Co.)

Enamel—Lonco GN-LR, Super X-VAR #622 (Fidelity Chemical Prod. Corp.), X-VAR #306 (Fidelity Chemical Prod. Corp.)

Formex—Super X-VAR #622, X-VAR #584 (Fidelity Chemical Prod. Corp.)

Formvar—Lonco GN-LR, Super X-VAR #622, X-VAR #306

Nyclad—Lonco GN-LR, X-VAR #584

Nylon—X-VAR #528 (Fidelity Chemical Prod. Corp.)

Thermaleze—Lonco GN-LR

Check clad and laminated  
metals, new and faster  
chemical wire strippers  
to cut costs and steps  
in assembly operations

# plastics get wider use as characteristics are broadened

*Mixing in other materials gives new properties to familiar basic plastics and produces entirely new ones that show promise*

**CONDUCTIVE PLASTICS**—Many plastics become electrically conductive when carbon black is used as a filler. New mixing techniques now give uniform and reproducible resistivities in desired ranges, to meet a variety of production requirements.

A tough rubber-like conductive plastic, recently announced as Eccosorb HF by Emerson & Cuming, is furnished in rods and sheets having five different volume resistivities ranging from 300 to 1,000,000 ohm-cm. Chief application is for dummy loads and waveguide terminations where high precision is not important. Features are high impact strength, dielectric constant of 25 and dissipation factor of 0.4 at 8,600 mc (for the 1,000-ohm-cm resistivity grade), and a temperature range of -100 F to 350 F. The material molds to a feather edge and to almost any contour for custom-molded shapes.

A conductive thermosetting plastic (Markite type G-169—Markite Corp.) for waveguide and coaxial attenuators, dummy loads and terminations gives controlled resistivities of 3, 15, 25, 50, 100 and 200 ohm-cm. High loss characteristics are maintained

over wide changes in temperature and humidity.

Markite F-163 is a conductive thermoplastic having an atomic composition similar to that of human tissue. Chief use is for studying intensity of radiation that would penetrate to vital organs under various atomic radiation exposure conditions.

Conductive plastics furnished on special order by Markite include thin unsupported films, used alone or bonded to plastics or metals, and materials having resistivities as low as 0.01 ohm-cm.

A flexible conductive plastic announced by Elektro-Serv Co. for use as flap attenuators, antenna loading disks, strip transmission line pads and crystal oven heaters can dissipate up to 20 w/sq in. and withstand temperatures up to 390 F. Available resistivities range from 10 to 5,000 ohm-cm.

Tape resistors somewhat equivalent to conductive plastics are made by Hansen Electronics Co. for mounting on glass or ceramic plates of printed or modular circuits. Though basically a carbon composition sprayed on a flexible plastic tape, recent improvements in fabricating techniques permit continuous operation at 392 F. Thinness of the tape also permits use for dissipative networks in radar applications.

A conductive version of Cohrlastic silicone gasketing material (Connecticut Hard Rubber Co.) is available with or without glass reinforcement, for applications requiring high-frequency shielding at gasketed joints. For the same shielding reason, Neo-Sil Products Division brings out a Graf-Sil conductive version of its modified neoprene for hermetic seals and for bushings of connectors and controls.

**FLUOROCARBONS**—Refinement is the goal of those supplying basic fluorocarbons. These include Teflon (du Pont's polytetrafluoroethylene), Kel-F (M. W. Kellogg's trifluorochloroethylene polymer), Bakelite's fluorothene and Acme Resin's Polyfluoron.

A du Pont treatment available to processors of Teflon chemically etches the surface to form the base for a mechanical bond with adhesives. This overcomes the anti-stick property of this material. The one-step treatment bath consists of liquid sodium dissolved in ammonia, with immersion for 1 to 5 seconds followed by cold-water quenching and drying.

Research by U. S. Gasket Co. under a Navy Bureau of Ships contract indicates that volumetric loading can be up to 30 percent for most fillers. Magnetic fillers such as 60-mesh ferrite (Ferramic J), 10-micron carbonyl iron HP or 8-micron iron-9 permit

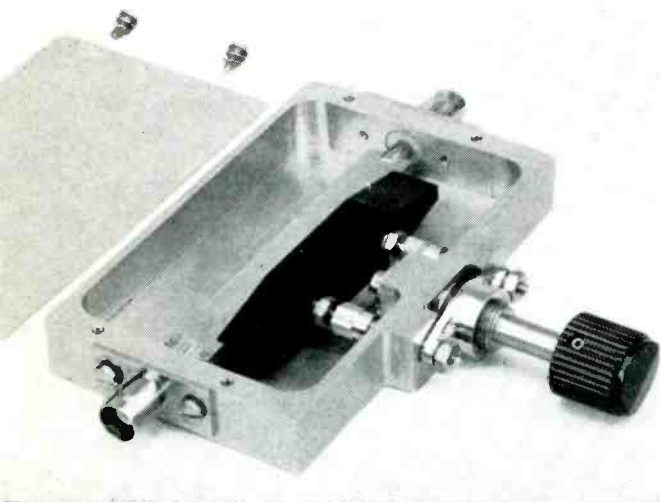

Variable attenuator developed by Raytheon uses shaped block of Markite conductive plastic to control oscillator power delivered to C-band mixer. Knob varies attenuation from 0 to 15 db by moving plastic block toward or away from slab-type line



use for tuning slugs, toroid cores and r-f matching stubs. General-purpose fillers include 325-mesh clear mica, quartz, and Zero-Plast ceramic (U. S. Gasket). Titanium dioxide can be used to increase the dielectric constant to a desired level. Barium titanate improves microwave transparency. Calcium boride, boron carbide and litharge improve resistance to neutron bombardment.

**NYLON**—Coil forms and other nylon parts having dimensional stability along with high abrasion resistance can be produced by cold pressing and sintering, using Nylasint powders developed by National Polymer Products from specially processed nylon and fillers. A comparable Nylatron GS powder for conventional injection molding equipment gives the same properties.

Applications of conventional molding nylon for coil forms and bobbins continue to increase because of the high dielectric strength, low moisture absorption and heat resistance up to 300 F. Firms making one-piece bobbins and coil forms include Cleveland Container Co. and Thor Ceramics. Examples of improved molding compounds include du Pont's Zytel and Barrett Division's Plaskon nylon.

**PHENOLICS**—New formulations continue to appear. One example is Borden's Durite for resistors, having good heat resistance and stability at 507 F. Another example is GE's 12906, a high-impact black phenolic molding compound for tube sockets, electrical controls, switch parts and other molded pieces; this

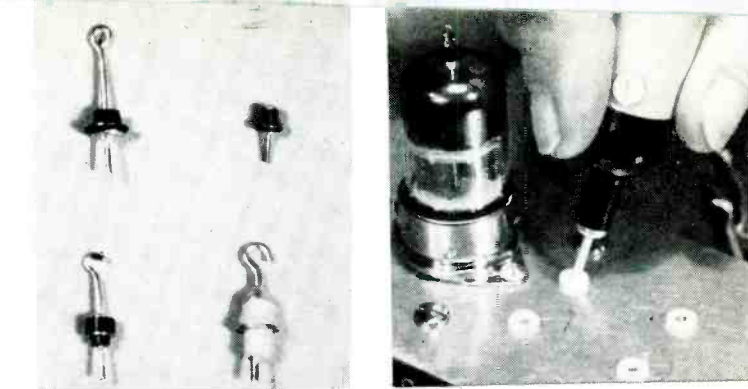

Examples of copper-bonded fluorocarbon feed-through terminals for hermetic seals, now in pilot-plant production by IRC. Copper surface permits conventional soldering to housings. Miniature color-coded Teflon terminals made by Sealectro lock into position when pressed into panel hole, eliminating mounting hardware

uses wood-flour and cotton-flock filler to give suitable granulation and fast cure for high-speed automatic molding.

Torkrite coil forms made by Cleveland Container Co. use still another new phenolic formulation, having good machinability along with high dielectric strength, as required to produce internal threads that give a smooth constant-torque action for threaded tuning cores.

**POLYESTERS**—Resins in this group include three different classes. One of these is the saturated polyester, of which Mylar and Dacron are examples, and the others are different types of unsaturated polyesters.

Applications for du Pont's Mylar polyester film have broadened with recent availability of 1/4-mil film having a low fault count. The high dielectric strength per unit thickness makes this film attractive for wound

## SOME NEW FLUOROCARBON MATERIALS

**Bondable Dixon Teflon**  
(Dixon Corp.)

Surface treatment roughens Teflon to give strong mechanical bond with appropriate adhesives, permitting cementing of thin sheets, rods, tubes and blocks to metal surfaces with tight sealed joints. Dixon's Bondable Teflon, a modified Teflon having great abrasion resistance, is also available now with cementable surfaces

**Califilm**  
(Shamban Engineering Co.)

Thin films of Kel-F or fluorothene, having new properties for insulating electronic components. May be sealed by r-f heating. Remains tough, transparent, nonporous and flexible over range from -120 F to 390 F. Short-time dielectric strength is 4,000 v/mil. Available in widths of 8" up and thicknesses from 0.0005" to 0.015". Also available as Bondized Kelon-T sheets and tape in Teflon for heavier insulation

**Duroid 5600**  
(Rogers Corp.)

Homogeneous sheet of Teflon reinforced with inert fibers to reduce cold flow and heat distortion. Uses include connectors, insulating gaskets, printed-circuit boards and bearings. Dielectric constant is 2.5 and power factor 0.003 at 1 mc, dielectric strength is 150 v/mil and 24-hour water absorption is 3%

**Fluorofilm**  
(Dielectrix Corp.)

Cast Teflon film has a low power factor up to 30,000 mc, volume resistivity over  $10^{15}$  ohm-cm and surface resistivity of  $3.6 \times 10^{12}$  ohms at 100% relative humidity, over temperatures up to 400 F. Chief uses are for dielectric of precision capacitors and for wrapping miniature cable. Requires special handling on winding machines due to static charges and to flexibility in thinness involved

**Polyfluoron**  
(Acme Resin Corp.)

A chlorotrifluoroethylene molding powder featuring zero moisture absorption, toughness, flame resistance and good electrical properties over a temperature range of -320 F to 390 F. Chief electronic uses are as wire coatings, gaskets, insulators, insulating tape and sockets. Also available as liquid dispersion for insulating coatings on wires, high-frequency coils, braided cable and sheet metal, applied by spraying, dipping or painting. Solvent in dispersion is evaporated with warm air and coating is then fused by baking at 475 F to 650 F

**R/M Teflon**  
(Raybestos-Manhattan, Inc.)

Basic material in many sizes and forms, including extruded tubes, molded rods and centerless-ground extruded rods, as well as special shapes custom-machined on lathes or automatic screw machines. Most shapes also available in Raylon reprocessed Teflon at lower cost

**Teflon rod**  
(Tri-Point Mfg.)

New extrusion equipment holds dimension tolerances of rods within 0.001" up to 1" dia in lengths up to 10' and more, with higher density and greater uniformity, to give higher degree of insulation continuity for machined r-f and uhf insulators. Lowered rod prices made possible by new machinery, with further savings through increased choice of diameters and lengths, cutting waste

## TYPICAL SILICONE RUBBER MATERIALS

<b>Cohrlastic</b> (Connecticut Hard Rubber Co.)	Silicone rubber and sponge material for high-temperature insulation where high dielectric strength is chief requirement. New HT 655 and HT 666 formulations have more than doubled tensile and tear strengths and improved abrasion resistance, through loading with Valron, Du Pont's ester-coated fine silica filler
<b>Neo-Sil</b> (Neo-Sil Products Division)	Modified neoprene having good adhesion to metals. Chief use is for hermetic seals, for molded cables with attached plugs and for waterproof bushings on panel controls and switches
<b>R/M</b> (Raybestos-Manhattan, Inc.)	Silicone rubber compounds available in colors, including orange tan, red, amber, brown and gray. Silicone rubber tubing is now extruded in wide range of wall thicknesses and inside diameters for flexible high-temperature cable jackets
<b>SE-100</b> (General Electric)	Series of silicone rubber compounds designed primarily for coating glass fabric for electrical insulation. Can be applied by dip coating or with knife. Cures faster and at lower temperatures than most other silicone compounds; 5 minutes at 255 F followed by 10 minutes at 480 F gives optimum electrical properties. Also suitable for encapsulation. Extrusion version for insulating wires is SE-460
<b>Silastic</b> (Dow-Corning)	Basic silicone rubber material. Heat-stable. Retains flexibility at temperatures from below -100 F to above 500 F and high corona resistance
<b>Union Carbide X-1516</b> (Union Carbide Corp.)	Silicone rubber compound having carbon-black loading to give electrical resistivities below 100 ohm-cm. Blending with other silicone rubber compounds permits adjusting resistivity to any value between this and 10 <sup>16</sup> ohm-cm. Will withstand up to 400 F for medium intervals with no loss in electrical characteristics. Can be molded, extruded or calendared. Applications include flexible heating elements, shielding and draining static charges. Also available as gum stocks (X-97 and W-95) for compounding with various silica, zinc oxide, calcium carbonate and other fillers to obtain desired characteristics

paper capacitors, coil insulation and wire insulation.

Precision stamping facilities have recently been set up by Tri-Point Mfg. & Development Co. that will hold tolerances within 0.001 in. on Mylar films down to 1 mil thick.

Formed Mylar insulation and formed pieces of silicone-impregnated glass cloth are now being produced by Stevens Products as a substitute for hand taping or use of numerous die-cut pieces.

Another new insulating material for coils is GE's varnished Poly-Glass cloth using a combination of glass and Dacron threads.

Glass-fiber-reinforced polyester molding compounds having a wide range of physical and electrical characteristics have been brought out by Thermoflow Chemical Corp. as Thermoflow 100, 200, 300, 400, 500, 2,300, and 2,400. In addition, Thermoflow 1,000 uses nylon-rag reinforcement to give a smooth surface finish and other molding advantages. Other sources of glass-polyester materials include Glastic Corp., Plumb Chemical Corp. and Poreclain Products.

**POLYETHYLENE**—Natural polyethylenes have long been an important primary insulating material for high-frequency circuits. Now comes a rearrangement of molecules to give a strong, rigid and heat-resistant material sometimes called a superpolyethylene. Being produced under low pressure, it is also known as low-pressure polyethylene. The material can withstand up to 230 F continuously. Uses include extension shafts for controls, coil form tubing and high-frequency insulators.

Examples of superpolyethylenes include Super Aeroflex (Anchor Plastics Co.), Hi-fax (Hercules Powder Co.), Bakelite low-pressure polyethylene polymer, Super Dylan (Koppers Co.), Marlex 50 (Phillips Petroleum Co.) and Alathon (Du Pont).

New also are polyethylenes of intermediate density such as Du Pont's Alathon 34 and 37. High abrasion resistance and high resistance to deformation under

prolonged loading are characteristics meriting consideration here as coatings for wire.

Coating of Dacron fabric with Hypalon, Du Pont's chlorosulfonated polyethylene, gives a radome fabric capable of withstanding wind velocities up to 120 mph. Electrical properties of Dacralon fabric (developed by ARDC in conjunction with DeBell and Richardson) permit efficient transmission of microwave energy from the enclosed radar antenna to the target and back again.

**IRRADIATED POLYETHYLENE**—Bombardment of polyethylene with high-voltage electrons produces a plastic material having a combination of electrical properties. This irradiated polyethylene, available from GE as Irrathene film, is nonmelting and resistant to stress cracking and has good mechanical and elec-

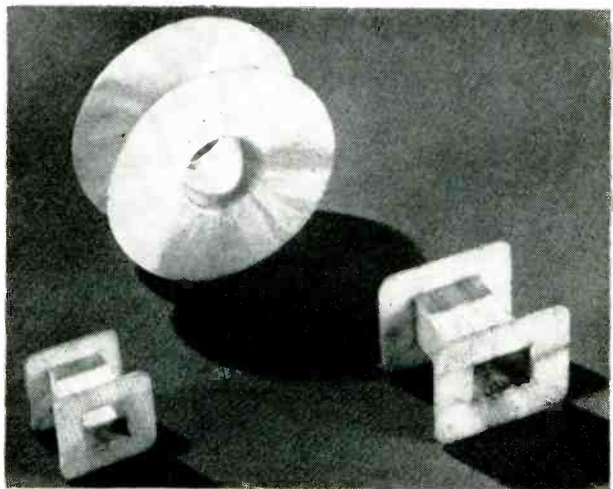

Glass-reinforced silicone bobbins are molded in two pieces by Stevens Products. Starting with uncured tubing, flange is drawn at one end and cured. Similar flange is drawn from slightly smaller tubing and cured. The two pieces are then telescoped after applying silicone adhesive to give bobbin having double-thickness core section

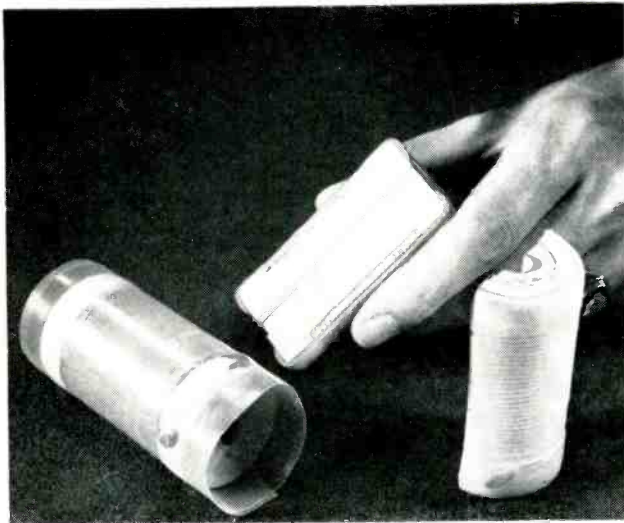

When coil wrapped with GE irradiated polyethylene film as at left is heated to 300 F, film shrinks over ends to provide complete encapsulation

trical properties for insulating coils and transformers. The encapsulation grades of film (Irrathene 110, 210 and 212) have higher tensile strengths, permitting use for enclosing irregularly shaped coils and other objects with a tough, waterproof sheath. Although this material will withstand severe short-time temperature overloads (as high as 480 F), it is normally rated for continuous temperatures up to 255 F.

For encapsulating, the irradiated film is wound around the coil or other object under moderate tension, then heated to around 275 F. At this temperature the tape tries to shrink in the lengthwise direction, thereby applying a pressure that causes the layers to bond together into a substantially uniform encapsulating sheath.

A continuous operating temperature of 300 F is one useful property of Hyrad, a modified irradiated polyethylene brought out by Sequoia Process Corp. as a high-temperature insulation for wiring. All shaping of the plastic must be done first, because the material becomes thermosetting after irradiation with an electron beam.

**POLYSTYRENE**—Polystyrene modifications in Dow Chemical's Styron line include Styron 440 which adds high heat resistance to high impact strength and good moldability for radio cabinets, and Styron 665 with desirable extrusion characteristics along with a relatively high heat distortion temperature.

A rigid, clear cross-linked polystyrene (Polypenco Q-200.5—Polymer Corp.) for machining uhf insulators has high impact strength (0.35 to 0.50). Dielectric strength of 350 v/mil, dielectric constant of 2.5 to 2.6 and dissipation factor of 0.0002 hold for practically the entire frequency range to 10,000 mc. At low frequencies, dielectric strength goes up to 1,500 v/mil. It is available in rods up to 8 ft long and plates up to 2 ft square. Similar easy-to-machine polystyrene is available from Emerson & Cuming as Sty-cast 0005 and from Rex Corp. as Rexolite.

By loading cross-linked polystyrene with titanates in varying amounts, Emerson & Cuming produces plastic rod and sheet stock of adjusted dielectric constant for special r-f and microwave applications.

**SILICONES**—Continuous rating for the molding resin is now around 400 F. Use of a glass filler boosts this to 450 F and permits short-term exposure to 700 F. Low-loss electrical properties remain unimpaired to 570 F.

Although silicone molding compounds are thermosetting, a new family of silicone alloys developed by Delaware Research and Development Corp. is thermoplastic. Four different alloys are currently available. Logical uses include antenna insulators and radomes for submarines and surface vessels, as well as microwave antenna lenses, waveguide windows and insulators. Alloying constituents include vinyl polymers and copolymers, polyethers and other polymers.

Silicone molding materials have recently been made available by Bakelite Co. as developmental products. Continuous temperature rating is around 550 F for all.

Dow-Corning 301 is a high-impact glass-filled silicone molding compound.

**OTHER PLASTICS**—New formulations are being brought out almost daily in all classes of plastics, hence oftentimes a manufacturer can furnish material most suitable for a particular design problem even though it is not mentioned in existing literature.

One example of a new formulation is Cymac 400, just brought out by American Cyanamid as an injection molding compound for radio cabinets, based on methylstyrene.

Also new is Cymac 201, a methylstyrene-acrylonitrile copolymer for injection molding of radio cabinets and other electronic equipment housings where a light straw color is permissible.

In the alkyd classification, Barrett Division of Allied Chemical & Dye Corp. has brought out new Plaskon molding compounds in granular, putty and filled forms featuring high arc resistance, dimensional stability and high dielectric strength.

Of importance for their dielectric characteristics are the new diallyl phthalate molding compounds currently being produced by Acme Resin, Durez and Mesa Plastics. These have high dielectric strength (around 350 v/mil), along with dimensional stability and good arc resistance. Applications under consideration or already in use include terminal boards, printed circuit boards and connectors.

Evaluate new plastics with  
an open mind but put them  
through accelerated aging  
tests before sending old  
reliables out to pasture

# wires with new insulations have wider environmental range

*New insulating materials and extruding techniques widen working-temperature ranges, meet miniaturization demands and cut coil-winding costs for practically all types of wire used in electronic assemblies*

**CERAMIC INSULATION**—Power and r-f transformers operating continuously at temperatures well over 930 F (500 C) have just been demonstrated by GE Research Lab. The wire used, now being produced in diameters ranging from 5 to 70 mils, is clad copper coated with a high-temperature glass which provides protection from oxidation along with electrical insulation.

**FLUOROCARBON HOOKUP WIRE**—Ease of stripping, integral color striping for identification, lengths to 2,000 ft without splices and resistance to soldering-iron temperatures are among the features of fluorocarbon-insulated hookup wires recently brought on the market.

Examples include HiTemp Wires' Temprene and Temprex in sizes 14 to 32 using Teflon; Revere's Permacode (using Teflon) and Revcothene using monochlorotrifluoroethylene insulation; Surprenant's Surco using Teflon; Tensolite's four Teflon types—extruded, parallel-wrapped, spiral-wrapped and 5-mil-wall sub-miniature; Union Plastic's Teflon with integral color striping; Warren Wire's Glastite 1021 with Teflon-im-

pregnated Fiberglas over Teflon insulation on stranded copper; Warren Wire's similar WW500 having glass also in the primary Teflon insulation to meet requirements for high-temperature aircraft cable.

Teflon insulated magnet wire is now available in a full range of sizes from 14 to 50 AWG to meet class H insulation ratings. Sources of this new fine-gage magnet wire include Hitemp Wires (Temprite) and Warren Wire Co. The latter provides two coating thicknesses, one giving 600 v/mil and the other 1,000 v/mil.

**POLYVINYL CHLORIDE**—Rubber-like elasticity, high dielectric strength, high insulation resistance and resistance to weathering and aging are features of improved polyvinyl chloride insulations and jackets for wires. Temperature rating is around 215 F. Typical examples are Geon 8800, 8801 and 6373 (B. F. Goodrich Chemical Co.), Opalon 1406 (Monsanto) and Alpha 1851 (Alpha Wire Corp.). Geon 8720 is a polyblend that will not affect polyethylene.

**SILICONE INSULATION**—High dielectric strength of 1,200 v/mil and 300 F continuous rating are features of Hitemp Wires' new Thermalon silicone-enameled magnet wire, made in single and heavy coatings on wire sizes 14 to 42 AWG.

Brought out for miniaturized equipment where soldering must be done in close quarters, William Brand's Turbotemp 200 will withstand short-term immersion in molten solder.

## THREE TUBINGS FOR WIRES

CDF Petu (Continental-Diamond Fibre);  
Flexite (L. Frank Markel);  
Polypenco (Polymer Corp.);  
Temprene (Hitemp Wires);  
Tensolite (Tensolite Insulated Wire Co.)

**Fluorocarbon Tubing.** Teflon spaghetti, extruded to have thin walls, retains flexibility over temperature range of -95 F to beyond 500 F. Most manufacturers of this tubing now offer it in colors for wire identification, in wide range of diameters, for wire gages 8 through 30. Resists fungi, corrosive fumes, alkalis and solvents

Turbo 117 (William Brand)

**Silicone Tubing.** Retains electrical insulating qualities when pressed against hot, sharp terminals or components or when under severe mechanical stresses at extremes of temperature. Highly flexible

Flexite (L. Frank Markel);  
Hygrade (L. Frank Markel);  
Resinite (Resin Industries)

**Vinyl Tubing.** Polyvinyl chloride tubings such as Flexite give low-temperature flexibility and wet dielectric strength and resistance. Vinyl-coated Fiberglas tubings such as Hygrade VF retain flexibility after exposure to transformer oil for 60 days at 265 F; can be obtained with fungi-resistant coating. Vinyl compounds such as Resinite Super Heat 125 resist hot oil, varnish or pitch up to 220 F, have high cut-through resistance yet remain flexible to -40 F; Resinite EP-93 withstands -90 F to 250 F for military electronic equipment, and EP-69A is multipurpose tubing for high dielectric strength (750 v/mil) from -50 F to 195 F. A Resinite vinyl glass tubing having high abrasion and cut-through resistance will withstand such mechanical flexing as a 180° mandrel bend at -45 F

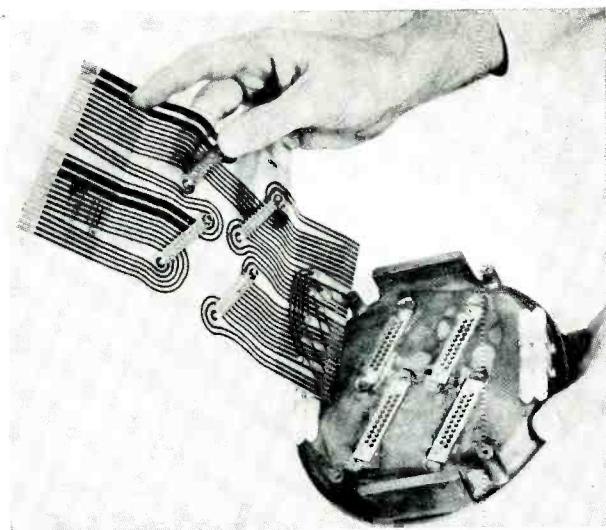

Examples of flexible printed-circuit cables and wiring harnesses produced by Sanders Associates

**SELF-STRIPPING MAGNET WIRE** — Among magnet wires that can be soldered without cleaning is a new type of Sodereze brought out by Phelps Dodge, based on isocyanate resins in sizes from 16 through 44. Electrical properties are good at high humidity. It is not affected by styrene and epoxy resins, hence should be suited for encapsulating applications. Soldering temperature is around 750 F.

Addition of a high-friction coating to Sodereze gives Grip-Eze, for winding universal coils without fabric coverings or adhesives.

Another example of a self-fluxing, self-soldering wire is Soderex (Essex Wire Corp.), using a modified polyurethane enamel on wire sizes of 28 and smaller. Stripping requires a tin bath at 660 F.

**ENAMELED WIRE**—Typical of recent improvements in enameled copper magnet wire are Isonel and Alkanvar (Acme Wire Co.), which give heat resistance to 300 F and a high cut-through temperature (thermoplastic flow at 465 F), along with high resistance to solvents and chemicals.

**PRINTED CABLES**—Complex wiring harnesses, cables and contoured circuits are being produced on flexible sheet Kel-F fluorocarbon material with printed circuit techniques developed by Sanders Associates. The method permits incorporating a tear-away feature as required for clean severing of the umbilical cable of a missile when it takes off.

**MULTICONDUCTOR CABLES**—Practically any desired combination of insulated wires can be obtained today in the form of flat-ribbon or conventional round cables, shielded or unshielded. All-Teflon insulation gives complete waterproofing and minimum size in the Tempbraid version by Hitemp Wires, useful for miniature cable assemblies. Goodline Corp. puts out two-

conductor line in a polyethylene sheath for all-weather low losses, using either a solid or perforated polyethylene web between the conductors.

**COAXIAL CABLES**—New cables continue appearing, to meet special requirements or do conventional jobs better. For physical strength as required for lowering radiation counters into uranium drill holes, Belden has brought out logging cable 8721 with breaking strength of 250 lb and outer diameter of 0.205 inches; nominal capacitance is 25  $\mu\text{mf}/\text{ft}$ .

For other minimum-diameter applications, Federal Telephone and Radio and others have miniature coaxial cables, those involving high temperatures often using Teflon solid dielectric.

Precision Tube Co. features a seamless outer conductor giving 100 percent shielding for its Coaxitube semirigid transmission lines, permitting preforming for fast assembly.

Also newsworthy are cables using foam polyethylene as the dielectric to give low attenuation along with light weight; examples include Federal's Foam-Poly, a JT coax by Times Wire and Cable Co., and United States Rubber Co.'s Airfil which extrudes the foam as a spiral fin between inner and outer tubes of polyethylene to get still more air as dielectric.

**RESISTANCE WIRE ALLOYS**—For resistor ribbon, Carpenter Steel's Stainless No. 1-JR achieves good scale-resisting properties through alloying with a small amount of aluminum, while providing a wide useful range of resistivities.

A high resistance (800 ohms per circular mil foot) and a low temperature coefficient of resistance (0.00002 per deg C) are features of a new Evanohm alloy by Wilbur B. Driver, available bare or enamel-insulated in ultrafine sizes down to 0.005 in. for miniature precision-wound resistors and precision potentiometers. Finest size gives 3,200 ohms per ft. It can be produced in premium grade with 0.000003 coefficient (resistance change of 3 parts per million per deg C) for use in resistance standards. A similar Driver-Harris alloy 531 has a specific resistance of 1,000 ohms per cmf, an analysis of 75 percent Ni and 20 percent chromium plus aluminum, and a size range from 0.010 in. (10 ohms per ft) down to 0.0008 in. (1,562 ohms per ft).

Ability to withstand high processing temperatures and high resistivity are characteristics of Kanthal Corp.'s DR resistance wire, made from a magnetic alloy. New also is this firm's Nikrothal L, which soft-solders easily and has low thermal emf to copper.

The right wire for your product's environment is the only one to use when long-term reliability is required

# solders and fluxes approach the goal: Perfect joints

*Despite engineering and production know-how today, bugaboos of rosin joints, horns, webs between printed wires, partly soldered joints and corrosion from flux residues still limit reliability of electronic equipment. Here are new answers to the problem*

**FLUX-CORE SOLDERS**—Many examples of new flux-core solders appeared recently. Nuax (National Lead Co.) has a mildly activated rosin-flux core for pretinned or readily soldered metals, leaving minimum residue. Hyax (National Lead Co.) has a strongly activated rosin-flux core for use on tarnished or oxidized parts. Anchor Metal Co.'s new purified metal solder with highly activated rosin flux serves for production-line soldering of copper, brass, nickel-plate, cadmium-plate and other metals.

Soft-solder alloys by Kester Solder Co., Alpha Metals and others use up to 5 percent antimony in the near-eutectic lead-tin formulation to give great hardness, tensile strength and creep strength. Ersin Multicore Savbit (Multicore Solders Ltd.) contains a small percentage of copper along with an extra-fast noncorrosive flux.

New paste solders include Lotemp (Micro Instrument Co.) with noncorrosive flux and Alcho-Re Fluxes (Electrovert Inc., U. S. agent for Fry's Metal Foundries Ltd.). The latter firm has also brought out F. E. F. silver solder paint which can be dropped at required points on a printed circuit and then fused by high-frequency induction heating or by electrical resistance soldering. Melting range of the paint is around 1,100 F. The paint can also be used for silver brazing where members must fit closely.

**FLUXES**—Protective-coating types of fluxes are available for dip-soldering problems. These are applied by dipping or spraying as soon as possible after a wiring board has been plated or etched, then dried for a few minutes in warm circulating air. The resulting coating is dry enough to permit handling of the boards, protects the wiring from corrosion during storage and serves as the flux for dip-soldering. Examples here include Kester flux formula No. 1571, Fluxcote No. 21XR (London Chemical Co.), Sealbrite 230-10 water-dip lacquer (London Chemical Co.), Flux-Coat 391F

(Alpha Metals, Inc.) and Photofinish No. 4 (Photocircuits Corp.).

Liquid rosin fluxes differing chiefly in the nature of their activating agents have been developed to minimize residue after dip-soldering. This is achieved by widening the temperature range for maximum activity as well as by control of flux purity. Alpha 346 is one example, giving good capillary action on two-sided boards. Rosin X by M. W. Dunton Co., Diamond flux by Accurate Specialties Co., Kester formulas 1547, 1545, 1544, 1015, 1045 and 1013, EHL Flux by Electro-Lab Processes, Inc., and Superior No. 30 by Superior Flux & Mfg. Co. are the other examples here.

A viscous flux brought out by Alpha Metals as Flux-Ink contains a dye for increased visibility. This is intended primarily for use at printed-circuit soldering inspection positions, where it is applied to indicate spots requiring resoldering and to provide new flux.

**FLUX REMOVERS**—Demand for complete elimination of rosin residues from soldered joints has resulted in development of fast and effective liquid solvents. Typical of these is Kester AP-20. This solvent has a mild fruity odor and is relatively nontoxic.

**SOLDER RESIST**—For area or spot selective soldering on printed wiring boards, London Chemical Co. has brought out Lonco PE33 solder resist coating. This has a low curing temperature and short cure time, after which it withstands solder pot temperatures with no breakdown, peeling or cracking. Prevention of bridging between conductors is one advantage.

The proper combination of  
solder, flux, temperature  
and time can give perfection  
in dip soldering only if the  
materials being soldered  
do not themselves  
contaminate the solder pot

# Transistorized Receiver for VEHICULAR RADIO

By SEYMOUR SCHWARTZ\*

*Lincoln Laboratory  
Massachusetts Institute of Technology  
Lexington, Massachusetts*

**SUMMARY** — Military communications receiver is redesigned from i-f on using transistors. Advantages include reduced battery power drain and increased audio output. Sensitivity, selectivity and voltage-regulation remain about the same. Grounded-base circuits assure interchangeability of transistors and eliminate need for i-f neutralization. Individual transistor-diode voltage-regulators provide voltage stability for bfo, i-f and audio sections

**T**RANSISTORS have been used successfully in all sections following the mixer of a 500-kc to 32-mc vehicular radio receiver originally designed to use electron tubes. The receiver handles radiotelegraph, radiotelephone and single-channel, frequency-shift radio teleprinter signals. Operation is from 28-v, d-c. This receiver is a multiple-conversion superheterodyne.

The hybrid receiver reduces battery power drain by one half with double its original audio power output. It has an agc system that controls both the electron-tube and transistor sections simultaneously. The i-f bandwidth is constant for variations in signal strength. Sensitivity is comparable with that of the electron-tube model as is the voltage-regulating action. Performance is shown in Fig. 1.

The sections transistorized are the i-f and audio amplifiers, the agc system, calibrator, squelch and beat-frequency oscillator. Twenty-five tubes were replaced with 21 transistors and 10 diodes. The transistorized subchassis is mechanically and electrically interchangeable with the corresponding electron-tube subchassis. The schematic diagram of the transistor-

ized sections is shown in Fig. 2.

The transistorized i-f section uses mechanical filters to provide a constant bandwidth over the complete range of input signals. Voltage stability is maintained over the range of supply variations by a transistor-Zener diode voltage regulator,  $Q_{17}$  and  $D_2$ . Need for i-f neutralization is eliminated and interchangeability of transistors assured by the grounded-base connection.

The gain of the transistorized i-f amplifier is 90 db. This is equal to the gain of the electron-tube i-f amplifier. The first four stages of the i-f amplifier are automatic-gain controlled. The bandwidths of 2, 4 and 8-kc are obtained by Collins

mechanical filters. Intermediate-frequency selectivity is shown in Fig. 3A.

## Audio and Agc

The audio amplifier consists of a grounded-emitter, medium-power driver  $Q_{12}$  and a grounded-base, class A push-pull power output stage,  $Q_{13}$  and  $Q_{14}$ . This section has a gain of 60 db and a maximum undistorted power output of 500 mw at 24 v. The audio-frequency response compares favorably with the audio-frequency response of the electron-tube model. See Fig. 3B.

The r-f agc system of the electron-tube circuit was incorporated in the overall agc system. The only

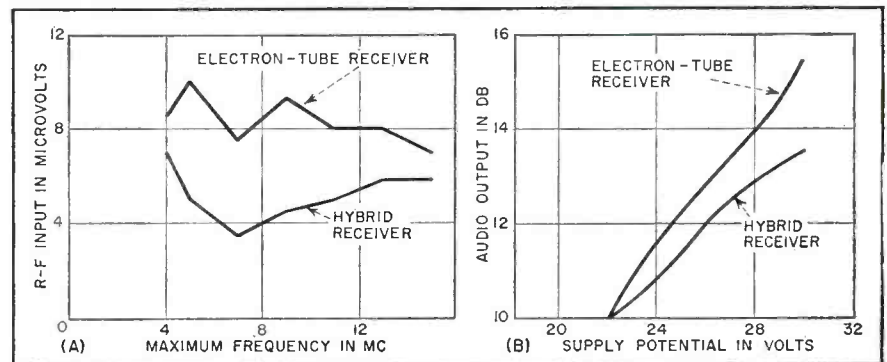

FIG. 1—Receiver sensitivity characteristics for 9-kc bandwidth and 10-db signal-to-noise ratio at 10-mw output (A). Also, effect of supply-voltage variation with 30-percent r-f signal input modulated at 1 kc. Receiver bandwidth equals 8 kc (B)

\* Now General Manager, Transistor Applications Co., Boston, Mass.

change in the r-f agc system is use of silicon diodes  $D_8$  and  $D_9$  instead of electron-tube diodes.

The i-f agc section consists of an agc diode  $D_6$  and a d-c agc amplifier  $Q_{10}$ . With agc disabled, the output of the d-c amplifier is held at a fixed reference level. This reference voltage is connected through the agc bus to the bases of the first four i-f stages  $Q_1$ ,  $Q_2$ ,  $Q_3$  and  $Q_4$ . The emitter current of each of the four stages is determined by the difference between the agc reference voltage at the base and the fixed voltage at the emitter divided by the value of the resistance. With agc on an increase in signal strength causes an increase in d-c voltage at the output of the agc amplifier, which results in an increase in the base voltages of the controlled i-f stages.

In turn, the difference voltage between the base and emitter decreases, lowering the emitter cur-

rent of each of the stages. Lowered emitter current results in increased emitter resistance, and, in turn, decreases the gain of the agc-controlled stage. The output signal variation is held to within 10 db for an input signal variation of 100 db. A comparison with the electron-tube agc system, Fig. 3C, shows the transistorized version to be within 3 db for these signal-level variations.

Diode  $D_6$  provides agc delay in addition to agc rectification. This delay is the result of the crystal end of  $D_6$  being set, with the absence of an input signal, at a more positive d-c voltage than the point-contact end. Therefore, until the input signal reaches a level sufficient to cause the a-c signal into the agc section to overcome this bias across the delay diode, no agc action will occur. The delay is controlled by the setting of the i-f agc delay. With agc operation the

amount of agc d-c voltage output at the emitter of  $Q_{10}$  is dependent on the amount of d-c voltage developed at the base. The d-c voltage is due to the rectification of the a-c input signal by  $D_6$ .

#### Bfo and Calibrator

To provide maximum beat-frequency-oscillator stability, the transistor bfo was built around Collins T602, temperature-compensated tank circuits. A separate voltage regulator is used for the beat-frequency oscillator.

The calibrator circuit consists of  $Q_{15}$  used in a blocking oscillator circuit and  $D_{10}$  used as a clipper to provide proper shaping. This circuit provides usable harmonics up to 30 mc in steps of 100 kc.

The squelch circuit consists of  $Q_{20}$  a grounded-collector, i-f isolating amplifier,  $D_7$  the squelch rectifier and  $Q_{21}$  a grounded-emitter d-c amplifier. With no signal input, the

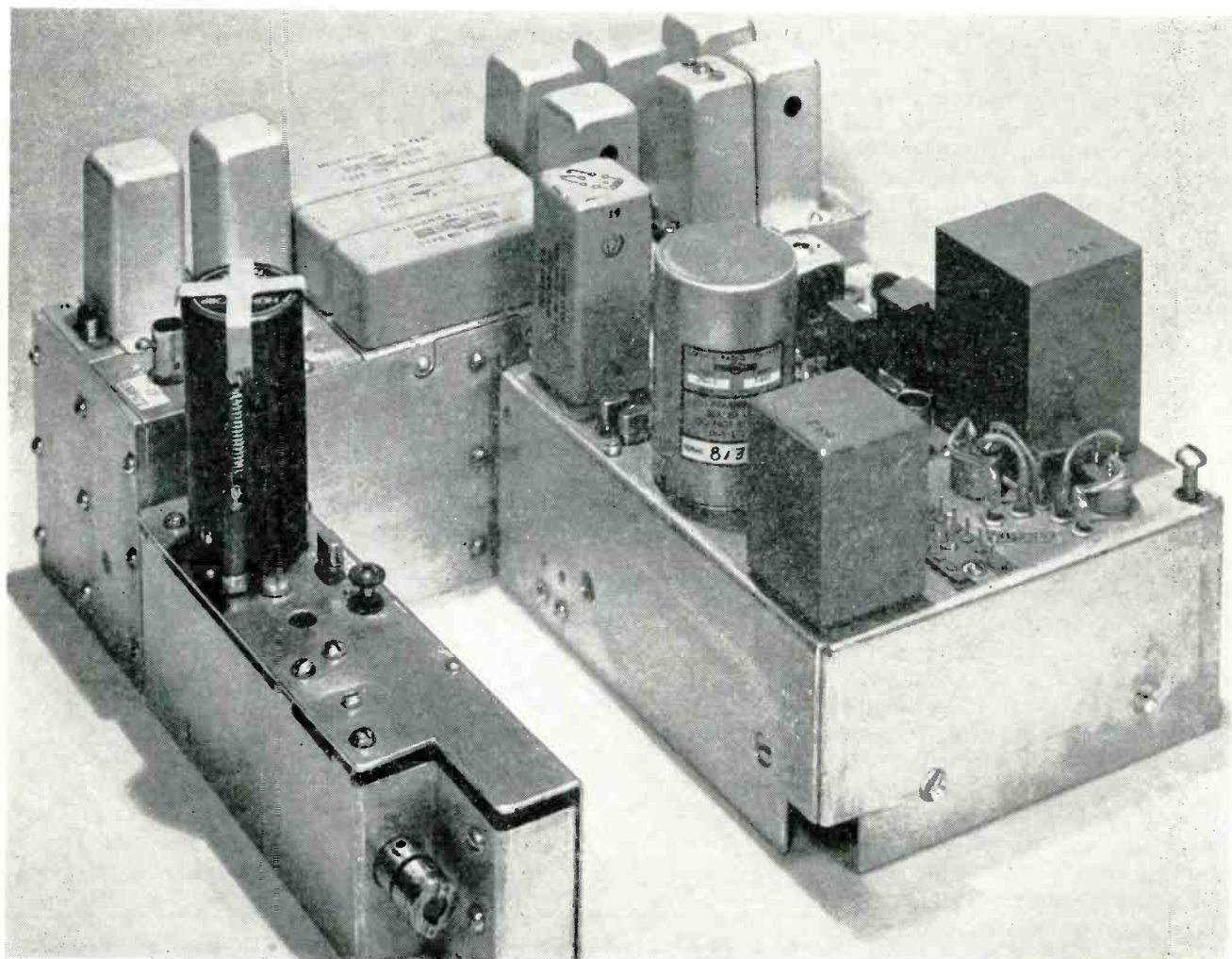

Transistorized portion of military vehicular radio receiver; space is left for plug-in electron-tube front end



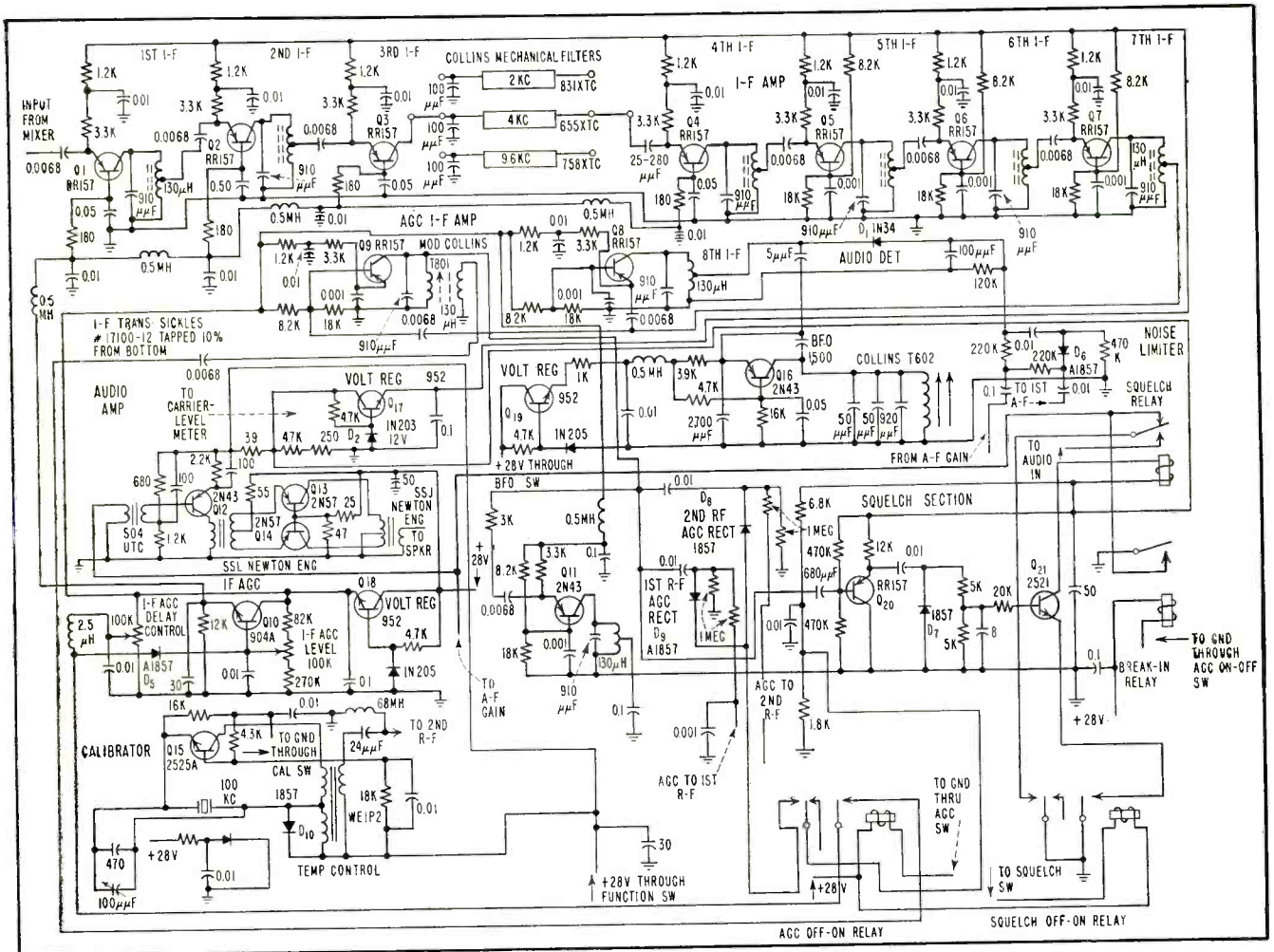

FIG. 2—Twenty-one transistors and ten diodes replace 25 electron tubes in i-f and audio amplifiers, agc system, calibrator, squelch and bfo of high-frequency communications receiver for military vehicles

d-c base current of  $Q_{21}$  is zero. The collector current is therefore the  $I_{c0}$  of a grounded-emitter stage and the relay is not energized. The relay contacts ground the input of the audio system, so there is no audio output.

With signal input the rectified d-c voltage at  $D_7$  causes base current to flow in  $Q_{21}$ , which, when amplified, results in a flow of collector current sufficient to energize the relay. The relay lifts the audio input from ground and audio output is available. The signal amplitude needed to operate the squelch circuit is determined by the r-f gain control.

### Output and Limits

The output isolation stage  $Q_{11}$  provides a low-impedance i-f signal output for teleprinters.

The noise limiter  $D_6$  and audio detector  $D_1$  are identical with the electron-tube receiver except that

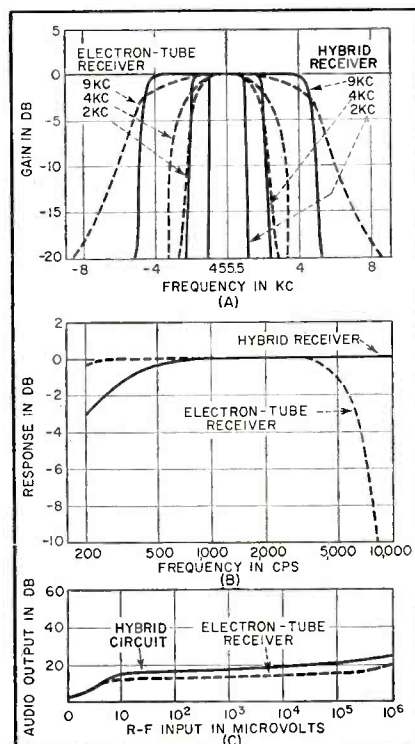

FIG. 3—Curves for i-f amplifier

silicon and germanium diodes are used rather than vacuum diodes.

Three transistor voltage-regulator circuits using Zener-voltage-breakdown diodes as references are used. Each regulator circuit is operated well within maximum power dissipation limits.

### Power Consumption

The total power drain of the hybrid receiver is 1.4 amperes. The total power drain of the corresponding electron-tube receiver is 2.7 amperes. The hybrid receiver is an experimental and not a pre-production model.

The author thanks W. E. Morrow for his guidance and D. W. Gosselein for construction and testing of the receiver, also S. Berger of SCEL. The work reported in this article was supported jointly by the Army, Navy and Air Force under contract with Massachusetts Institute of Technology.

# Phase Generator for

By R. W. HUBBARD and M. C. THOMPSON, JR.

National Bureau of Standards  
Boulder, Colorado

**SUMMARY** — Laboratory-standard instrument provides phase-displaced signals, either pulses or sinusoids, for checking and calibrating phase-shifting networks, oscilloscope sweeps, phase meters and other instruments where separation of periodic signals is important. Phase displacement may be selected in steps of two electrical degrees over range of 360 degrees

**R**ECENT RESEARCH in the field of tropospheric radio propagation, has included an investigation of phase-of-arrival variations in radio waves propagated over single and multiple paths.<sup>1</sup>

This program has made use of several commercial phase meters<sup>2, 3</sup>,

a microwave refractometer<sup>4</sup> (whose metering circuit is essentially a phase-meter) and other phase-sensitive devices in the instrumentation. It was found essential to have a stable and accurate source of phase-displaced signals available for use in testing, calibrating and

evaluating the performance of these instruments.

The laboratory-standard phase generator described in this article was based on an earlier technique<sup>5</sup> and has been applied with satisfactory results to the above problems. It provides a variety of useful signals with the desired accuracy and stability.

## Phase Generator

A functional block-diagram of the generator is shown in Fig. 1 and a complete schematic diagram is shown in Fig. 2.

There are five basic sections to the design, a crystal-controlled oscillator, a chain of fixed-ratio dividers, a second chain of dividers each with selective ratios, a series of flip-flops and the output stages.

Several of the divider stages and the flip-flop circuits are grouped into three functional channels. Two pulse-train output signals are derived, each with a pulse repetition frequency of 1 kc and with either polarity available. Sine-wave output signals are derived from the pulse train channels. The sine waves are available at the same frequency and phase-difference as the pulse-train outputs.

Any desired phase-displacement may be selected in discrete steps of 2 degrees throughout the entire

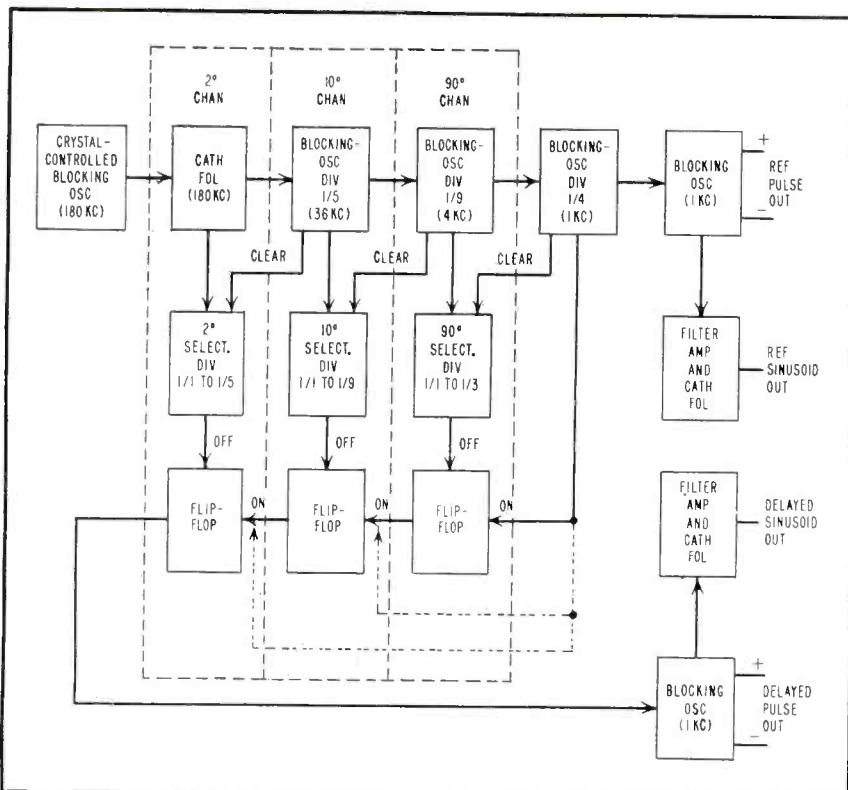

FIG. 1—Complete block diagram of laboratory standard phase generator

# Tropospheric Research

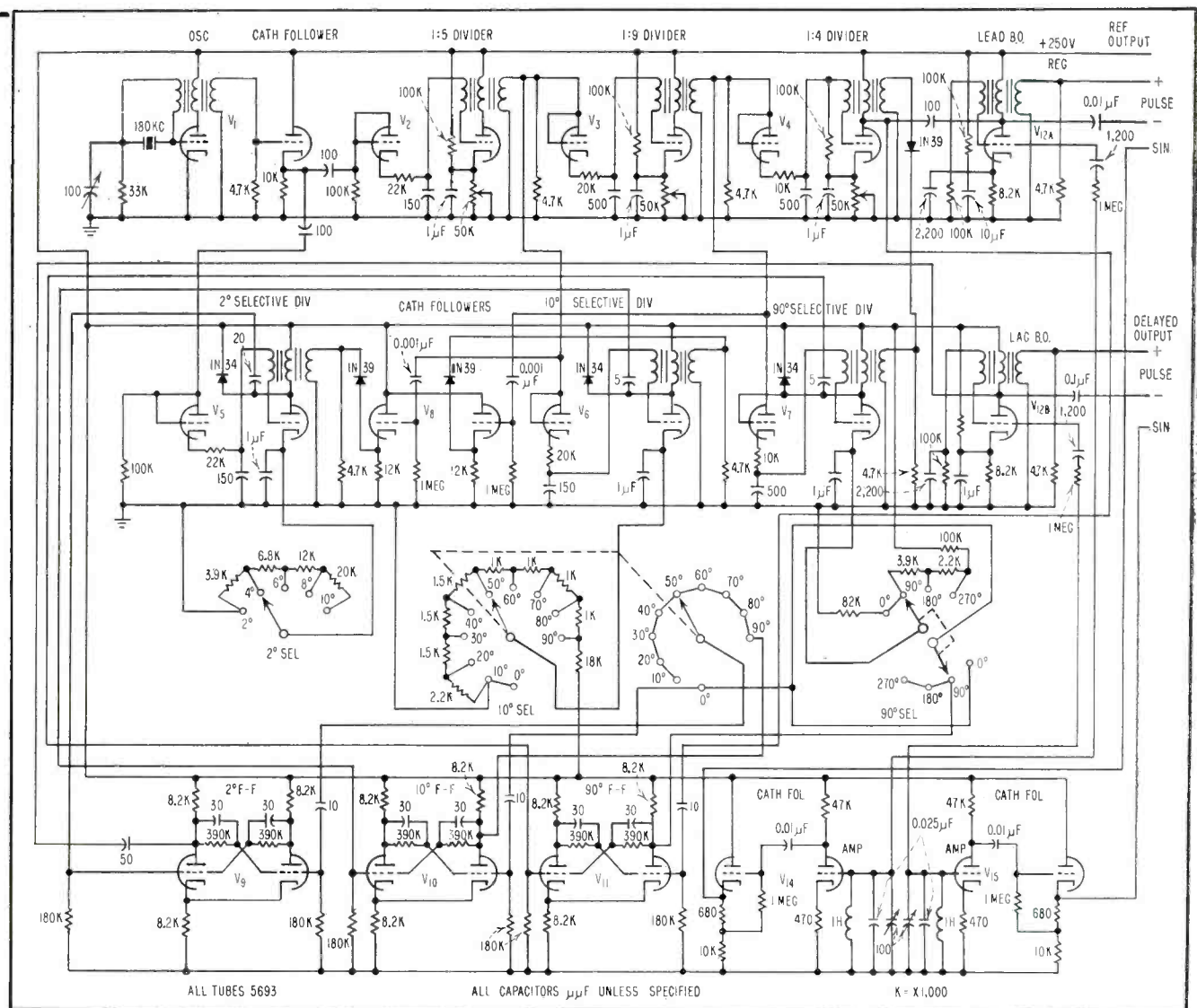

FIG. 2.—Subharmonic crystal oscillator  $V_1$  is used as basic generator to establish the repetition rate of output signals

range of 360 electrical degrees by setting three switches. The technique used in deriving the phase displaced signal is based upon a system of pulse selection from the oscillator pulse train. This particular technique is different from conventional methods and is considered to be simpler and less critical in design.

## Blocking Oscillator

A quartz crystal unit is inserted directly in the blocking oscillator circuit (Fig. 2) to synchronize the

prf. At each firing of the oscillator, the crystal is shock-excited by the negative swing of the plate voltage. The tube is rapidly cut off by the regenerative action of the stage and presents a high impedance to the crystal. The crystal continues to ring during the cut-off period and the ringing voltage is superimposed upon the grid-timing waveform. It thus synchronizes the firing point of the tube.

This circuit is a subharmonic oscillator\* and can be used to divide the crystal frequency down by

factors of several hundred. However, it is not employed here as a subharmonic generator, but is operated at the fundamental of a 180-kc quartz crystal unit.

## System Logic

The crystal-controlled prf of the basic oscillator is divided down by a total factor of 180 to an output repetition rate of 1 kc. This repetition rate is used as the phase-base of the instrument, its period represents 360 electrical degrees.

As indicated in Fig. 1, the basic

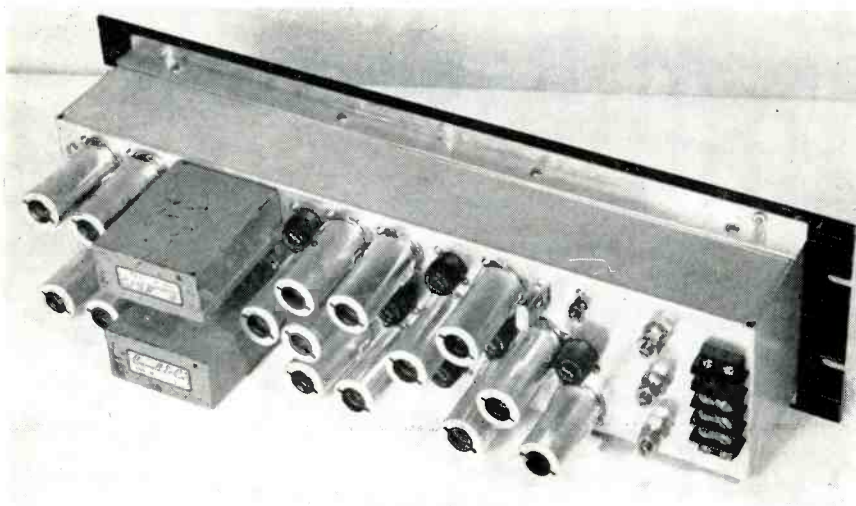

Complete phase generator mounts on standard relay rack

division takes place in the reference pulse channel, which consists of the crystal-controlled oscillator and cathode follower, three fixed ratio dividers of the blocking oscillator counting type and the output stages. The prf of each of these stages represent a particular division of the phase-base into angular increments of 2, 10, 90 and 360 degrees respectively. This relationship can be seen from the comparison of each prf to the base and can be expressed as

$$\Delta\theta = 360f_b/f_{\Delta\theta} = 360/f_{\Delta\theta} \quad (1)$$

where  $\Delta\theta$  = increment of angle in electrical degrees,  $f_b$  = base prf in kc and  $f_{\Delta\theta}$  = prf of particular stage in kc.

The cathode follower and the first two fixed ratio dividers are pulse-generators for the three functional channels of the instrument. The third divider in the reference chain is the base-generator and provides the phase-leading pulse-train output. The delayed or phase-lagging pulse train is derived by a coincident pulse selection technique.

From Eq. 1 it can be seen that each pulse separation in the 180-kc oscillator train represents an increment of 2 degrees. Thus, a particular pulse from this train is selected in the three selective channels as the phase-lagging signal.

#### Pulse Selection

Referring to Fig. 1, the output of the pulse-train generator heading each channel is fed to a selective divider stage. These circuits are also of the blocking-oscillator

counting type, with variable division ratios. The selective divider in the 2-degree channel may be set to count ratios of 1:1 to 1:5, thus deriving pulse-trains with pulse separations corresponding to 2 to 10 degrees respectively.

Similarly, the selective dividers in the 10 and 90-degree channels derive trains with pulse separations in discrete multiples of 10 and 90 degrees. Each selective divider count is cleared periodically by the pulse-train generator of the next higher channel to insure that the count in each of these stages begins in coincidence with a pulse from the following channel.

If the 90-degree selective divider is set for 270 degrees (counting by 3) and is not cleared in this manner, the stage will count 270 degrees in the first base period, but will generate a pulse corresponding to 180 degrees in the second base

period, 90 degrees in the third and so on. Therefore, a clearing pulse is applied from the base generator to clear the count at each 360-degree interval and thus insure an output pulse corresponding to 270 degrees in each base period. Similarly, the other selective dividers are cleared by their generators.

The clearing pulses are applied through crystal diodes and coupled to the selective dividers by the tertiary windings of the blocking oscillator transformers, as indicated in Fig. 2. Cathode followers are used in coupling the clearing pulse to the 2 and 10-degree channels to minimize loading effects.

#### Division Ratios

The division ratios in the selective dividers are established by the cathode bias of each stage. The ratios are changed in discrete steps by selecting the proper bias in a tapped resistive network.

The selective divider in each channel is followed by a flip-flop circuit and the divider pulse train returns the flip-flop to its off state. The flip-flop stages are triggered to their on state either by a pulse directly from the 1-kc base generator or by the trailing edge of the preceding flip-flop stage.

In this manner, only the first pulse occurring after the flip-flop has been turned on can return the stage to its off state. No subsequent pulses have any effect on the flip-flop. Consequently, each flip-flop operates at a prf of 1 kc established by the reference pulse-train.

The rectangular pulse-width generated in each flip-flop stage is equal in electrical degrees to the period of the prf selected in the divider stages, in accordance with Eq. 1. In this manner, the leading edge of the flip-flop pulse corresponds in angular position to 0 degrees or the angle selected in the next higher channel and the trailing edge corresponds to the angle selected in that particular channel, relative to the leading edge of the pulse. The flip-flops are cascaded so that the pulse widths are added together.

The trailing edge of the 2-degree flip-flop pulse corresponds to the total phase-displacement in degrees that is set into the instrument with

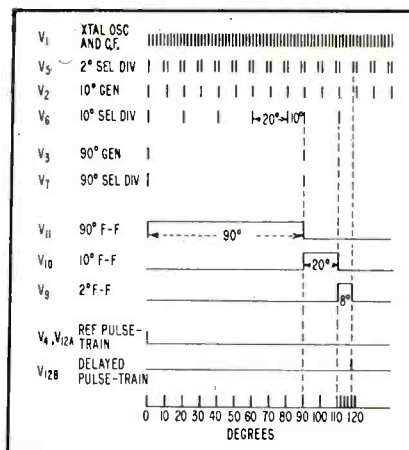

FIG. 3—Waveform sequence for circuit of Fig. 2

the selective switches. This trailing edge is then utilized, after differentiation of the pulse, to trigger a blocking oscillator identical to the reference output circuit. This blocking oscillator is the output stage for the phase-delayed pulse-train. Its output is at the same 1-kc base repetition rate, delayed in phase by the preset angle.

The delayed pulse has essentially been selected from the basic oscillator pulse-train using a complete coincident system. There are no gating circuits used in the normal sense of a gate.

### Operation

Suppose it is desired to have the delayed pulse-train lag the reference by an angle of 118 degrees. The selector switches are first set so that the total setting is equal to 118 degrees.

The waveform sequence in various stages of Fig. 2 for this particular setting are idealized in Fig. 3. The method of adding the flip-flop pulses along the phase-base is shown in this figure illustrating the relation between the trailing edge of the 2-degree flip-flop pulse and the selected pulse in the oscillator train.

The results of the clearing pulses are also evident in Fig. 3.

If the desired angle is within the first quadrant, the 90-degree selector switch is set to 0. In this case the reference pulse-train is fed directly to the 10-degree flip-flop and the leading edge of the flip-flop pulse then corresponds to 0. If the desired angle is less than 10 degrees, the switch in the 10-degree channel is set to 0, and the reference pulse is applied directly to the 2-degree flip-flop.

Two additional sinusoidal output waveforms, not shown in Fig. 3, are developed with the same phase-displacement as the pulse-train outputs. These are derived from the grid circuit waveforms of the blocking-oscillator output stages. Matched high-Q toroidal filter circuits are used.

### Accuracy and Stability

The prf is maintained with essentially the same stability as that of a crystal oscillator, a few parts per million. In this manner, the a-

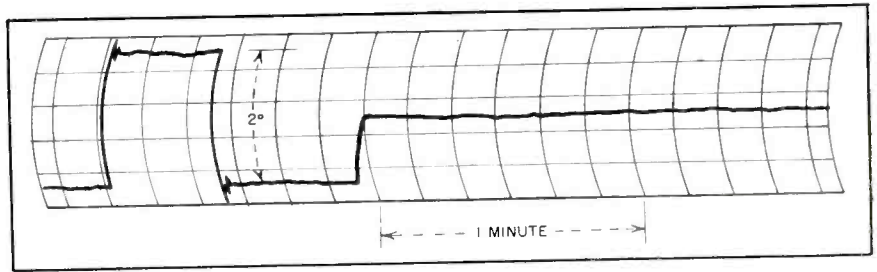

FIG. 4—Three-minute sample record of generator output obtained by using external amplifier, flip-flop and recording circuit of commercial phase meter

output is established with crystal accuracy and stability.

The phase separation of the output signals is also referred to the same quartz crystal unit. The stability of the phase separation has been evaluated to be considerably better than 1 part in  $10^4$ . This corresponds to a stability of better than 0.05 degree in 360 degrees, or 0.1  $\mu$ sec in 1,000  $\mu$ sec.

A typical recording of this measurement is shown in Fig. 4. This recording was obtained using one amplifier stage and the flip-flop and recording circuits of a commercial phase meter. Thus, the record includes the instabilities of these circuits as well as that of the phase generator. The record is for a period of three minutes, but is typical of longer periods.

There is one basic limitation to the instrument. This is a small error in the absolute phase angle, which is a result of the delay inherent in the reference pulse divider chain. The total delay was measured to be approximately 1.3  $\mu$ sec, equally distributed between the three basic divider circuits. This delay introduces an initial negative error of approximately 0.47 degree, in the absolute angle only and not present in the angular increments.

The accuracy of the increment was of primary concern in this design. However, if the absolute angle is to be more precise, this delay must either be reduced in the divider chain or compensated for in the delayed pulse channels.

Reducing the delay in the dividers is the desirable approach; the delay experienced can be reduced to the order of 0.3  $\mu$ sec or 0.1 degree.<sup>7</sup> The magnitude of this error, in any event, is a relatively fixed quantity and may be taken into account in application.

The technique presented may be employed on the basis of time separation rather than phase separation. The range of an instrument of this type is not limited to the audio and would have many applications in pulse work. In this case, Eq. 1 would become

$$\Delta\tau = 10^3/f_{\Delta\tau} \quad (2)$$

where  $\Delta\tau$  = increment of time in  $\mu$ sec and  $f_{\Delta\tau}$  = pulse repetition frequency in kc.

As an example of what can be done with this approach, each channel of the instrument in Fig. 1 may be made a decade stage. A second chain of decade dividers, identical to those used in establishing the pulse separation, may be used to establish the time base. A discrete number of output pulse repetition frequencies equal to  $(9n + 1)$ , where  $n$  is the number of channels, can be generated in this way.

If this instrument, for example, were designed to operate in the time domain, starting with an oscillator frequency of 200 kc the addition of only three stages would yield pulse separations from five to 5,000  $\mu$ sec over a range of prf from 200 kc to 200 cps. This range would be covered in 28 discrete frequencies.

### REFERENCES

- (1) J. W. Herbstreit and M. C. Thompson, Measurement of the Phase of Radio Waves Received Over Transmission Paths with Electrical Lengths Varying as a Result of Atmospheric Turbulence, *Proc IRE*, p 1,391, Oct. 1955.
- (2) E. F. Florman and A. Tait, An Electronic Phasemeter, *Proc IRE*, p 207, Feb. 1949.
- (3) Ernest R. Kretzmer, Measuring Phase at Audio and Ultrasonic Frequencies, *ELECTRONICS*, p 114, Oct. 1949.
- (4) G. Birnbaum, A Recording Microwave Refractometer, *Rev Sci Instr*, p 169, Feb. 1950.
- (5) M. C. Thompson, Crystal-Stabilized Pulse-Pair Generator, *Rev Sci Instr*, p 617, June 1955.
- (6) M. C. Thompson, C. E. Tschiegr and M. Greenspan, Subharmonic Crystal Oscillators, *Rev Sci Instr*, p 8, Jan. 1954.
- (7) Chance, "Waveforms," *MIT Rad Lab Series*, p 586 and 6 622, McGraw-Hill Book Co., Inc., New York, 1949.

# GAIN CHART for Transistor Amplifiers

**SUMMARY** — Graphical approach gives quick approximation of gain to be expected from grounded-emitter and grounded-collector amplifiers as frequency and transistor parameters are varied

By **GEORGE H. MYERS**

Rome Air Development Center  
Griffiss Air Force Base  
Rome, N. Y.

**D**ESIGNING transistor amplifiers involves calculating the gain as both the operating frequency and the transistor parameters vary. Use of a new

design chart that eliminates calculations in most cases is explained separately for grounded-emitter and grounded-collector amplifiers.

For a grounded-emitter amplifier, the chart shown in Fig. 1 uses the approximation that the current gain of such an amplifier

(the ratio of collector current to base current) is given by

$$G = i_c/i_b = \frac{\alpha}{1 - \alpha} \quad (1)$$

The frequency dependence of  $\alpha$  is customarily taken as

$$\alpha = \frac{\alpha_0}{1 + jf/f_0} \quad (2)$$

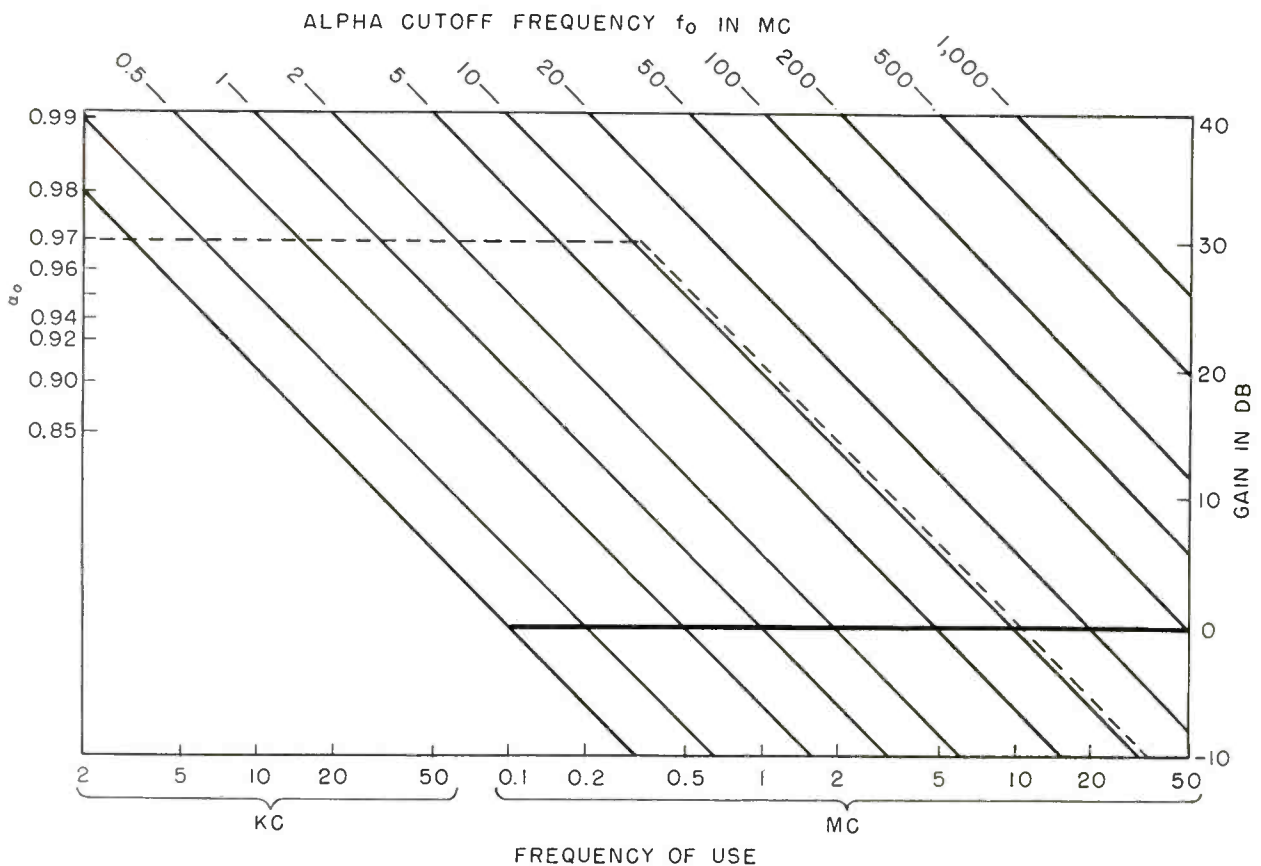

FIG. 1—Values of  $\alpha_0$  and alpha-cutoff frequency determine amplifier gain as a function of operating frequency

(Continued on page 226)

**Engineering - Development - Manufacturing -  
combined with Quality throughout make**

# **CINCH ★ SERVICE** **an important factor**

## **CINCH ELECTRONIC "STANDARDS":**

52 Contact Micro Connector can be supplied in 28, 32, 40, 48 and 52 Contact. Protective Hoods and Cable clamps available.



Sub-Miniature  
Hi-Temperature  
Sockets

25 Contact Edge  
Connector

JONES BARRIER  
TERMINAL STRIP

★ The addition of our Printed Circuit Plant at LaPuente makes "CINCH SERVICE" more complete than ever.

in the Supplying of Today's Electronic Requirements.

Many "firsts" have been developed by Cinch Engineers that have since become standards in the Industry. The experience of our engineers is wide and varied, and based on sound principles. They will design or redesign components to fit your specific requirements.

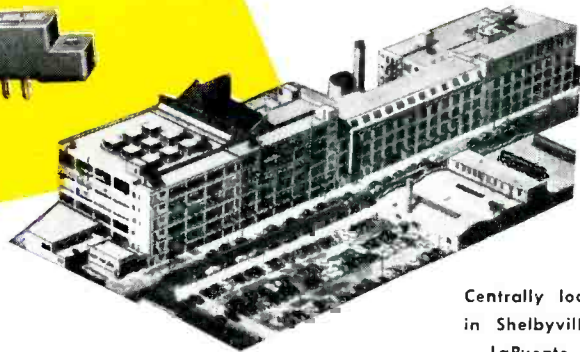

Centrally located plants  
in Shelbyville, Chicago,  
LaPuente, St. Louis

The Cinch Plant is modern in every respect—utilizing the latest manufacturing procedures with unlimited capacity so that you can be assured of a dependable source of supply regardless of quantities required.

All parts used in the manufacture of our products are carefully selected to make sure that they will best fulfill the requirements for which they are intended.

The consistent and constant performance of CINCH parts in the past quarter of a century have proved this quality of material and workmanship, as well as engineering design.

Whatever your Electronic Requirements might be — you can depend on CINCH.



**Cinch**  
ELECTRONIC  
COMPONENTS

## **CINCH MANUFACTURING CORPORATION**

1026 South Homan Ave., Chicago 24, Illinois

Subsidiary of United-Carr Fastener Corporation, Cambridge, Mass.

The low-frequency value of  $\alpha$  is  $\alpha_0$ ;  $f_0$  is the alpha-cutoff frequency. Figure 2A shows a typical grounded-emitter amplifier with the currents indicated.

If Eq. 2 is substituted in Eq. 1, the gain becomes

$$G = \frac{\alpha_0}{(1-\alpha_0) + jf/f_0} \quad (3)$$

For low frequencies, the gain is substantially independent of frequency and equal to  $\alpha_0/(1-\alpha_0)$ . For frequencies greater than  $(1-\alpha_0)f_0$ , the gain tends to fall off with frequency at the rate of 6 db per octave (or inversely proportional to frequency). This is the same frequency dependence as that of a low-pass R-C circuit followed by an amplifier, where the amplifier has a gain of  $\alpha_0/(1-\alpha_0)$  and the R-C circuit has a cutoff frequency of  $(1-\alpha_0)f_0$ .

### Gain-Frequency

The design chart gives the asymptotic gain-frequency curve—the gain is assumed to be constant at its low-frequency value up to a frequency of  $(1-\alpha_0)f_0$  and to decrease at the rate of 6 db per octave of frequency for all higher frequencies. This asymptotic characteristic is the one shown on reactance charts and is usually employed in servomechanism and feedback amplifier design. A simple correction is necessary to make the asymptotic characteristic exact.

For a transistor with an  $\alpha_0$  of 0.97 and an  $f_0$  of 10 mc, a horizontal line is drawn starting at 0.97 on the  $\alpha_0$  scale until the diagonal line corresponding to an alpha-cutoff frequency of 10 megacycles is reached. The diagonal line is then followed downward. On Fig. 1 this example is indicated by the dotted line, which shows the gain-frequency curve for this transistor.

Gain is read in decibels on the scale at the right and frequency is read on the bottom scale. Thus, this transistor has a gain of 30.1 db at 10 kc but at 1 mc

the gain is down to 19.6 db; at 20 mc, the gain is only -6 db. For values of  $\alpha_0$  and  $f_0$  not on the chart, it is necessary to interpolate.

Only a slight modification of this procedure is required to make the chart work for a grounded-collector amplifier (Fig. 2B). The current gain of the grounded-collector amplifier is approximately

$$G = i_c/i_b = \frac{1}{1-\alpha} \quad (4)$$

Using the Eq. 2 to determine how  $\alpha$  varies with frequency, the gain reduces to

$$G = \frac{1 + jf/f_0}{(1-\alpha_0) + jf/f_0} \quad (5)$$

The grounded-collector amplifier has a low-frequency gain of  $1/(1-\alpha_0)$ , which is nearly equal to that of the grounded-emitter amplifier. Between frequencies of  $(1-\alpha_0)f_0$  and  $f_0$  the gain decreases at 6 db per octave, like the gain of the grounded-emitter amplifier but after the alpha-cutoff frequency is reached the gain is constant at 0 db. The zero-decibel line of the chart has been made heavy and all diagonal lines intersect this line at a frequency equal to their alpha-cutoff frequency.

The gain for the transistor with  $\alpha_0$  equal to 0.97 and an  $f_0$  of 10 mc but connected in the grounded-collector circuit follows the dotted line in Fig. 1 until the dotted line intersects the heavy line and then follows the heavy line. This transistor as a grounded-collector amplifier still has a gain of 30.1 db at 10 kc and a gain of 19.6 db at 1 megacycle but at 20 mc the gain is about 0 db.

A slight error is made in using the chart for the grounded-collector amplifier, since the low-frequency grounded-collector gain is  $1/(1-\alpha_0)$  not  $\alpha_0/(1-\alpha_0)$ , but this introduces an error of only 1.4 db when  $\alpha_0$  equals 0.85

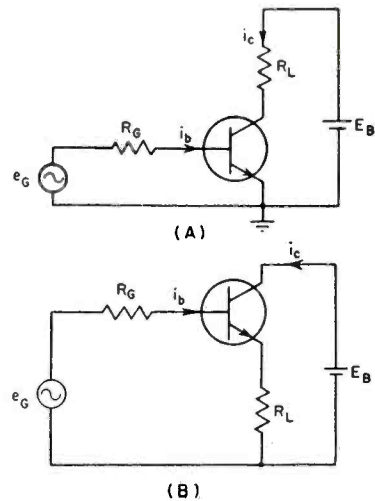

FIG. 2—Connections for transistor grounded-emitter (A) and grounded-collector (B) amplifiers

and is less for all higher values of  $\alpha_0$ .

The chart of Fig. 1 is only approximately correct, even for a grounded-emitter amplifier. A horizontal line corresponding to a value of  $\alpha_0$  should intersect a diagonal line corresponding to a particular value of  $f_0$  at a frequency equal to  $(1-\alpha_0)f_0$ . For a constant alpha-cutoff frequency, these intersections will not lie on a straight line having a slope of 6 db per octave. If the actual curve is approximated by a straight line that has this slope, however, the error in gain is about 1 db for an  $\alpha_0$  of 0.85 and is almost negligible for transistors with  $\alpha_0$  greater than 0.90.

### Accuracy

Such accuracy is adequate for a chart of this type, since the uncertainty in the values of the transistor parameters will probably introduce more error than the chart. For transistors with values of alpha above 0.95, where alpha may be known to three significant figures, the accuracy of the chart improves. For values of  $\alpha_0$  below 0.85 the error increases so fast that the chart loses its value in this region.



P. R. MALLORY & CO. INC.  
**MALLORY**

### MALLORY MERCURY BATTERIES



### TYPE TNT SUBMINIATURE CAPACITORS

*Mallory Mercury Batteries and Type TNT Subminiature Capacitors save space, provide superior performance in transistor circuits and other low-voltage miniature equipment.*

## Dependability in Miniature Size —to Work with Transistors

To power transistor circuits, Mallory Mercury Batteries are now manufactured by a unique "snap together" construction† that makes higher voltage ratings available at hourly operating costs even lower than conventional batteries. The new design comes in standard 15, 22½ and 45 voltages . . . can be produced in other ratings on order. A unique power source pioneered by Mallory, mercury batteries offer high energy content in small volume . . . far longer life in service and in storage. Service life up to three times that of usual dry batteries can be expected in transistor radios. Their constant discharge characteristic is ideally suited for transistor operation.

†Patent applied for

Parts distributors in all major cities stock Mallory standard components for your convenience.

#### Serving Industry with These Products:

**Electromechanical**—Resistors • Switches • Tuning Devices • Vibrators  
**Electrochemical**—Capacitors • Rectifiers • Mercury Batteries  
**Metallurgical**—Contacts • Special Metals and Ceramics • Welding Materials

**Subminiature Mallory Capacitors** offer ratings as high as 80 mfd. at 3 volts with *newly* developed type TNT tantalum capacitor. Only .145" in diameter by ⅜" long, it is especially useful in transistorized circuits. In this tiny case are offered a range of ratings never before possible in such small size. Five different values are available: 80 mfd., 3 volts; 50 mfd., 6 volts; 25 mfd., 15 volts; 15 mfd., 30 volts; and 8 mfd., 50 volts.

We'll be glad to consult on your specific circuit requirements, and to send full technical data. Just write or call Mallory today.

**Expect more . . . get more from**

P. R. MALLORY & CO. Inc.  
**MALLORY**

P. R. MALLORY & CO., Inc., INDIANAPOLIS 6, INDIANA

## Slow-Scan TV Described At Wescon

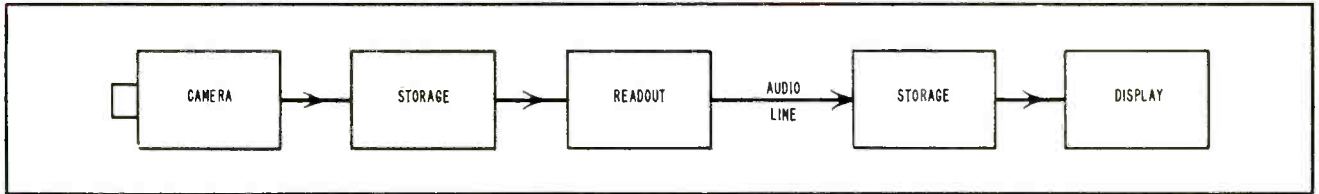

Elements of wire-line television system include storage means at transmitting and receiving ends so that picture elements can be sent slowly and displayed when complete picture has been assembled

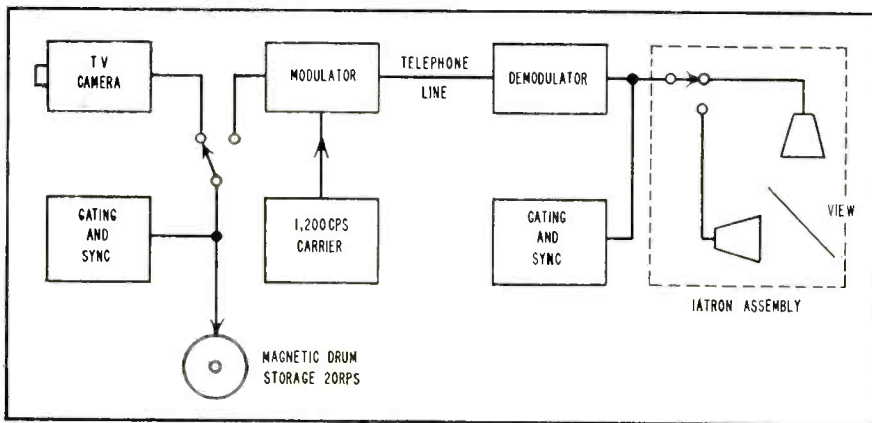

Block diagram shows basis of a typical working system of wire-line slow-scan television developed by Bell Labs

SOME recent developments in the field of slow-scan tv point up its future potential.

**Picture-phone**—As its name implies, this new system makes possible the transmission of a caller's picture along with the voice using ordinary telephone wires. Now under development at Bell Telephone Laboratories the system utilizes a slow rate of transmission of picture information.

The raster is made up of 60 lines, each of which may have a maximum of 40 dots. If a single frame were transmitted each second, an over-all bandwidth of 1,200 cps would be necessary. With the present system, one complete picture is transmitted every two second, an overall bandwidth of 600 cps.

This 600-cycle band contains very low frequency components, there-

fore, a scheme is employed where the signal amplitude-modulates a 1,200-cycle carrier. This signal lies within the range of optimum transmission of telephone lines and so can be treated like a voice signal.

► **Converter**—A compatible system that changes fast tv to slow-scan tv by an electronic converter



One of the possible ways a slow-scan picture-phone system may look when development work is completed.

has been developed by GE. The slow-scan tv system produces one picture every four or five seconds and is still in the laboratory development stage.

The Bell Labs papers describing picture-phone were presented at a Wescon session devoted to narrow-band television.

Here the Dage closed-circuit equipment suitable for use on class A telephone lines was also described.

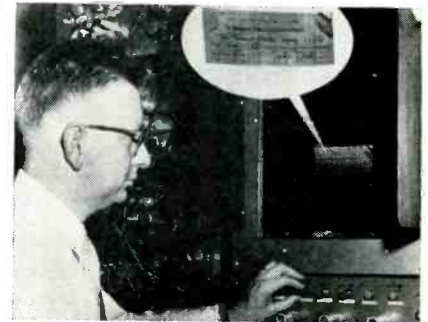

Slow-scan converter is adjusted to produce clear image of check

Direct-view storage tubes developed at Hughes Aircraft were the subject of one paper.

Melpar's visual communication system for air traffic signaling can be operated at any chosen bandwidth between 800 cps and 100 kc.

Greatest possibilities lie in uses not requiring transmission of motion. Future use of modified telephone lines may eliminate long hook-ups with coaxial cable. Slow-scan television can be sent many miles at reasonable cost.

continued on p. 230

# KEPCO

## VOLTAGE REGULATED POWER SUPPLIES

for powering electronic equipment

### SERIES

with **NEW-IMPROVED FEATURES**

- ★ **FAST** RECOVERY TIME
- ★ **GOOD** STABILITY
- ★ **LOW** OUTPUT IMPEDANCE

**KR** Voltage Regulated Power Supplies are conservatively rated and are designed for continuous duty at 50°C ambient.

**REGULATION:** Less than 0.2 volts for line fluctuation from 105-125 volts and less than 0.2 volts for load variation from 0 to maximum current.

**RIPPLE:** Less than 3 mv. rms.

**STABILITY:** The output voltage variation is less than the regulation specification for a period of 8 hours.

**RECOVERY TIME:** Less than 50 microseconds. The excursion in the output voltage during the recovery period is less than the regulation specification.

**OUTPUT IMPEDANCE:** Less than 0.1 ohms from 20 cycles to 100KC. Less than 0.5 ohms from DC to 20 cycles. Many units have very much lower output impedance.

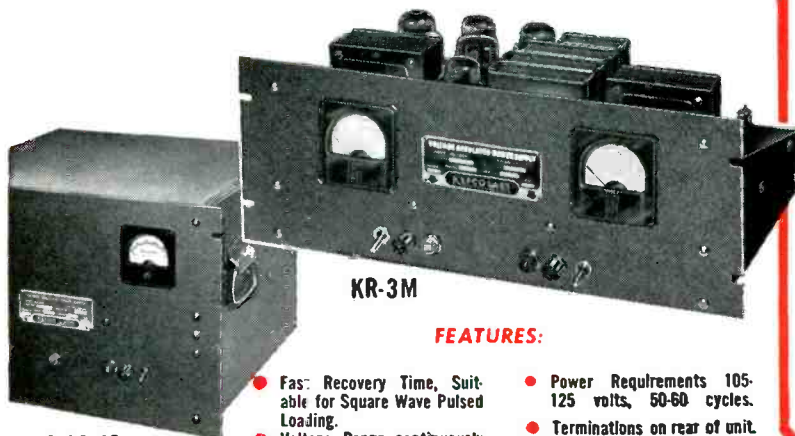

KR-18MC

KR-3M

**FEATURES:**

- Fast Recovery Time, Suitable for Square Wave Pulsed Loading.
- Voltage Range continuously variable without Switching.
- Either Positive or Negative may be Grounded.
- Oil Filled Condensers.
- Wire Harness and Resistor Board Construction.
- Power Requirements 105-125 volts, 50-60 cycles.
- Terminations on rear of unit.
- Locking type voltage control AC, DC Switches, Fuses, and Pilot Lights.
- Color Grey Hammettone.
- Guarantee One Year.

All models available for 400 cycle operation on special order.

### 1.5 Amp. **KR** SERIES

Model	Volts	6.3V AC	Rack Mount			Price
			W	H	D	
KR16	0-150	Each supply	19"	12¼"	17"	\$625
KR17	100-200	has two	19"	12¼"	17"	\$625
KR18	195-325	15 Amp.	19"	12¼"	17"	\$695
KR19	295-450	outputs	19"	12¼"	17"	\$695

### 600 ma. **KR** SERIES

Model	Volts	6.3V AC	Rack Mount			Price
			W	H	D	
KR 8	0-150	Each supply	19"	10½"	13"	\$330
KR 5	100-200	has two	19"	10½"	13"	\$240
KR 6	195-325	10 Amp.	19"	10½"	13"	\$240
KR 7	295-450	outputs	19"	10½"	13"	\$250

### 300 ma. **KR** SERIES

Model	Volts	6.3V AC	Rack Mount			Price
			W	H	D	
KR 12	0-150	Each supply	19"	7"	11"	\$270
KR 3	100-200	has two	19"	7"	11"	\$180
KR 4	195-325	5 Amp.	19"	7"	11"	\$180
KR 10	295-450	outputs	19"	7"	11"	\$190

### 125 ma. **KR** SERIES

Model	Volts	6.3V AC	Rack Mount			Price
			W	H	D	
KR 11	0-150	Each supply	19"	7"	11"	\$180
KR 1	100-200	has one	19"	7"	7½"	\$ 90
KR 2	195-325	3 Amp.	19"	7"	7½"	\$ 90
KR 9	295-450	output	19"	7"	7½"	\$ 97

To include 3" Current and Voltage Meters, Add M to Model number (e.g. KR 16-M) and Add \$30.00 to the Price.  
To include Dust Cover and Handles for Table Mounting, Add C to Model number (e.g. KR16-C) and Add \$10.00 to the Price.  
To include Meters, Dust Cover and Handles, Add MC to Model number (e.g. KR-16 MC) and Add \$40.00 to the Price.

PRICES F.O.B. Flushing.

### A LINE OF 50 MODELS

Available from Stock - Catalog on Request



# KEPCO LABORATORIES

131-38 SANFORD AVENUE • FLUSHING 55, N.Y. • INDEPENDENCE 1-7000

VISIT BOOTH #126-7 - NEC SHOW - CHICAGO - OCT. 1-3

## Three-Band Storm Detecting Radars



Severe storms and hurricanes can be tracked up to 250 miles away on new weather radars

NEARLY four million dollars is being invested in 39 radar equipments to be used, upon delivery in 1958, for storm detection. Navy Bureau of Aeronautics will employ eight

and the U. S. Weather Bureau the balance.

Manufactured by Raytheon, each unit is designed to operate 23 hours a day and will have an effective op-

erating radius of 250 miles. Three operating frequencies will be furnished: 9,300-9,500 mc (X band); 5,600-5,650 mc (C band) and 2,700-2,900 mc (S band).

► **Pulse Rate**—Three modes of operation are possible at each frequency. A short-pulse mode using 0.5 microsecond pulses at about 1,000 pps and a long pulse of 4  $\mu$ sec at 200 pps are available. There is also a 2  $\mu$ sec pulse width.

Range marks are provided at 1, 5, 25, 100 and 400 miles. A storm can be analyzed by using the off-center ppi and enlarging a selected area for detailed study. The antenna can be sector-scanned in either azimuth or elevation.

Peak power output is 250 kw at the two higher frequencies and 500 kw on S band. Receiver and duplexing system are mounted on the antenna pedestal, rather than being located at the console.

## High Temperature Transmitting Tetrode



Ceramic power tetrode is forced air-cooled and fits into special socket designed for new type construction

FABRICATED entirely of ceramic and metal, including ceramic support of internal electrodes, a new Eimac transmitting tube has been produced that will operate at 250 C under conditions of severe vibration.

Approximately 2½-in. long and 1½-in. in diameter, it will withstand repeated 11-millisecond 50-g shocks in any plane without either internal short circuits or mechanical damage. There are no major electrode resonances between 30 and 2,000

cycles per second of vibration.

Designated 4CX300A, the tube has an anode dissipation of 300 watts and can be operated at full ratings through 500 mc. As an oscillator or r-f power amplifier, it will operate at 500-w input or at 300-w input as a plate-modulated r-f amplifier.

## Transistors For UHF

A NEW TECHNIQUE for the mass production of high-speed and uhf transistors results in two new types, a micro-alloy transistor (mat) and a surface-barrier diffused transistor (sbd). Both are in engineering development at Philco.

Developed in cooperation with the Navy, Army Signal Corps and the Air Force, the new devices will be used in computers, guided mis-

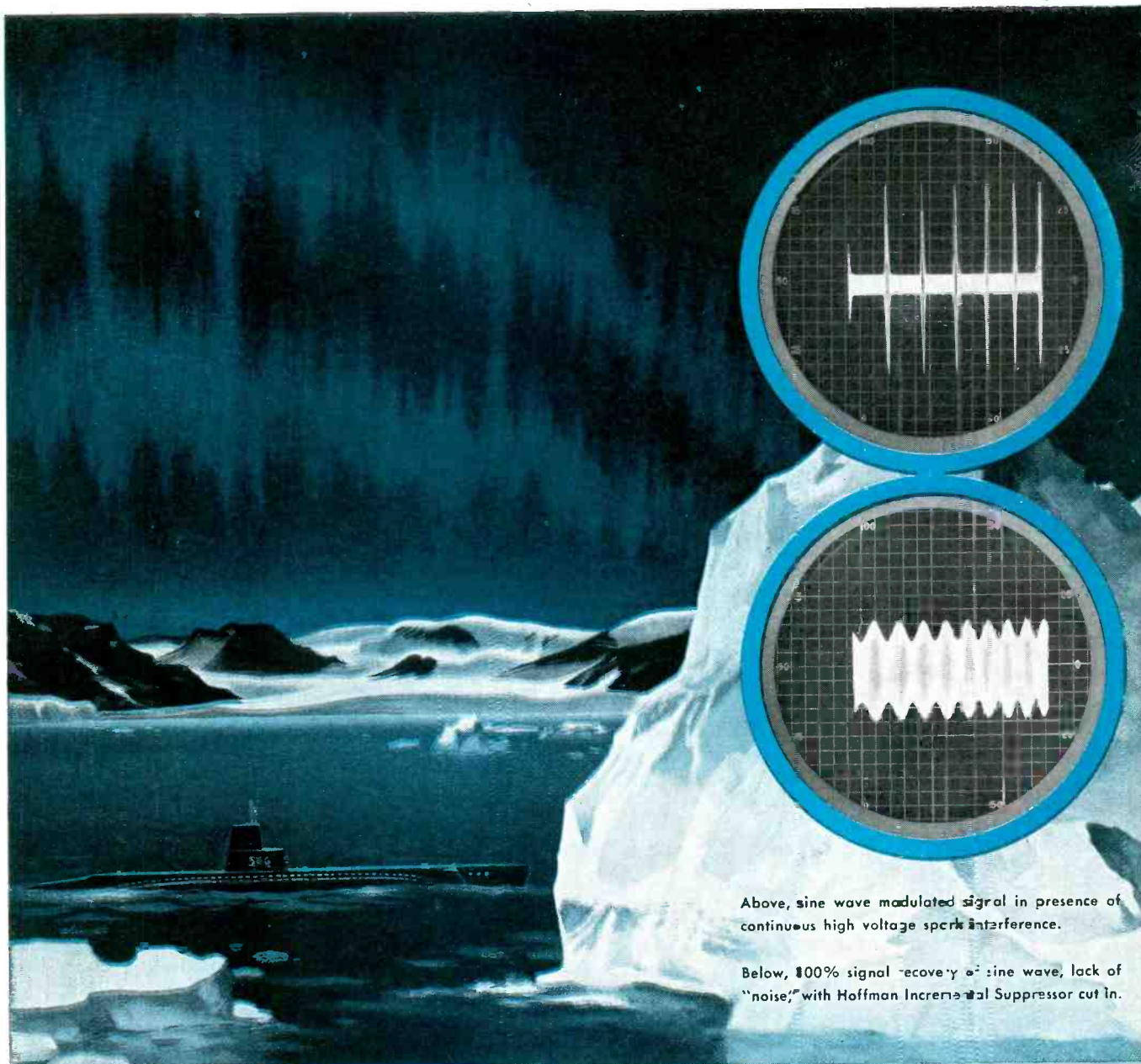

Above, sine wave modulated signal in presence of continuous high voltage sparks interference.

Below, 100% signal recovery of sine wave, lack of "noise," with Hoffman Incremental Suppressor cut in.

## HOW TO GIVE NOISE THE SILENT TREATMENT

**SITUATION:** A submarine surfaced somewhere in iceberg country, attempting to establish communications with distant base.

**PROBLEM:** Interference, or "noise," critically garbles message reception. Radio operator cannot hear message above interference.

**SOLUTION:** Operator switches on Hoffman Incremental Interference Suppressor, an exclusive feature of Hoffman Communications Receivers. Atmospheric noise is silenced—vital message comes through loud and clear.

This significant achievement in the science of communications has undergone extensive field tests under rugged service conditions. Tests demonstrate that in CW, FSK and AM communications, Hoffman-developed noise limiting techniques can give 100% message recovery from a signal containing atmospheric static 80 decibels greater than the carrier. Interference caused by static,

corona discharge, lightning and most man-made noise is reduced to a minimum. Result: clear, reliable radio-communications under extremely adverse operating conditions. The imaginative engineering teamwork and skill that pioneered in the reduction of noise in radio communications is ready to tackle your communications problems too—from basic research through final production.

*Hoffman Laboratories is engaged in these many other associated fields of electronics:* Airborne Radar and Navigational Equipment... Missile Guidance and Control Systems... Electronic Countermeasures... Advanced Communications Techniques in the VLF, HF, VHF and UHF regions... High Speed Search and Electronically Tuned Receivers.

This creates a constant need for engineers and physicists of highest calibre. Professional stature in mechanical engineering, electrical or electronics engineering or physics is required.

Write Vice President of Engineering:



A subsidiary of Hoffman Electronics Corporation  
3761 SOUTH HILL STREET, LOS ANGELES 7, CALIFORNIA



Engineer prepares germanium blanks for new surface-barrier diffused transistors. Tiny boats in the quartz tube carry bits of germanium while gas flowing through the tube, as it rests in the furnace, contains particles of metal which diffuse into the surfaces of the germanium blanks. The technique includes etching to give

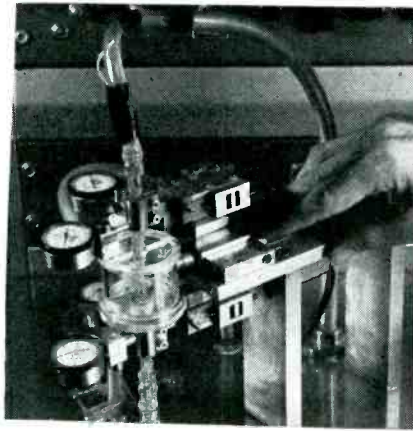

alpha cutoff frequencies above 600 mc. The surface-barrier diffused transistor in precision plate position. In this position, two indium dots are plated into the etch pits which were prepared in previous operations. The size of the jets, the voltage and solution determine the characteristics of the collector and emitter electrodes

siles, communications, radar and other military equipments.

Primarily designed for high-speed electronic computers, the mat employs microalloying process which uses doped semiconductor

layers only a few millionths of an inch thick. The new device is reported to be at least ten times faster than the fastest vacuum tube in electronic computers where the new devices can be employed.

## Wave-Modulated Oscilloscope For TV



Novel cathode-ray tube being examined by I. W. Fuller, Jr. of NRL was developed by Sylvania for the Navy. The screen diameter is 5 inches. Larger tube in experimental radar circuit is inspected by N. L. Davis

DEVELOPED several years ago, but only recently declassified by Naval Research Laboratory, the wamo-

scope (wave-modulated oscilloscope) combines in one envelope a broad-band traveling-wave tube and

an oscilloscope for normal display.

The tube was demonstrated by Sylvania engineers at Wescon in the form of a television receiver that did not require local oscillator, mixer, i-f amplifier, detector or video amplifier. Program from a local vhf channel was used to modulate the output of a 3 kmc transmitter beamed to a receiving dish in the same room. The receiving equipment is thus tremendously simplified.

Engineers indicated that it would be possible to build a similar type of receiver to operate directly in the uhf television band. It was predicted that a sensitivity of  $-40$  dbm and a noise figure of 4 or 5 db would not be impossible to achieve.

Military closed-circuit television and radar will be the initial uses of the new tube.

## Electronics Defends B-52



Tail section comprising optical sight (top) search radar and antenna (center) and tracking radar system (bottom) is being installed on B-52 intercontinental H-Bomb carrier

DESIGNED to defend its own aircraft against attack, the B-52 Defensive System is a self-contained AA fire-control system made up of three basic elements. They are: an optical sight for separate manual and override control of the system; a search radar; and a tracking radar. The system provides a track-while-scan feature.

► **Computation**—From the time the system sights a target and locks on to it, until the time the guns are aimed no more than three seconds elapse.

Range, range rate, angular posi-

**CLASS H PLUS**

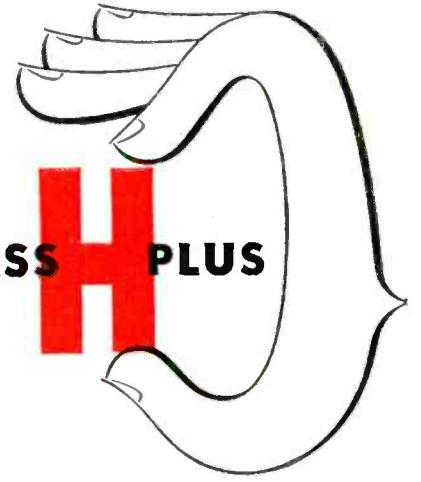

**THERE IS ONLY ONE MAGNET WIRE  
WITH AN EXTREMELY HIGH SPACE FACTOR  
CAPABLE OF SUCCESSFUL,  
CONTINUOUS OPERATION AT  
250°C**

CEROC is an extremely thin and flexible ceramic insulation deposited on copper wire. This ceramic base insulation is unaffected by extremely high temperatures. Thus, in combination with Silicone or Teflon overlays, Ceroc insulations permit much higher continuous operating temperatures than are possible with ordinary insulations.

There are three standard Ceroc Wires: Ceramic Single-Teflon and Ceramic Heavy-Teflon for operation at 250°C. feature unique characteristics of flexi-

bility, dielectric strength and resistance to moisture. They have been used successfully to 300°C in short time military applications. Ceramic Single-Silicone, for 200°C application, pairs the ceramic with a Silicone reinforcement to facilitate winding.

All three Ceroc Wires have far superior cross-over characteristics to all-plastic insulated wire—all provide an extraordinarily high space factor that facilitates miniaturization with high-reliability standards. ★ ★ ★ ★

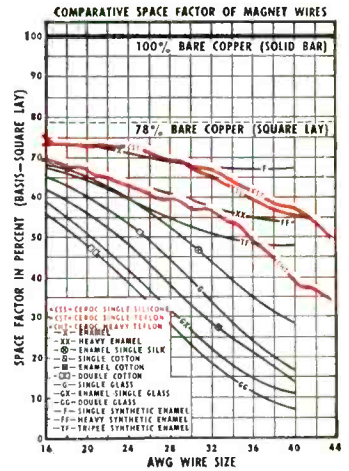

**IT IS SPRAGUE'S ...**

**Ceroc**<sup>®</sup>  
CERAMIC INSULATED MAGNET WIRE

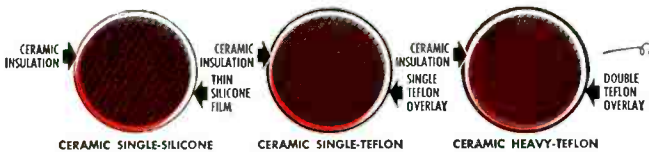

**ENLARGED CROSS-SECTIONS OF CEROC<sup>®</sup> COPPER MAGNET WIRE**



**FOR COMPLETE ENGINEERING  
DATA ON CEROC WIRES,  
WRITE FOR BULLETIN 400A.**

**SPRAGUE** ELECTRIC COMPANY • 35 MARSHALL ST. • NORTH ADAMS, MASS.

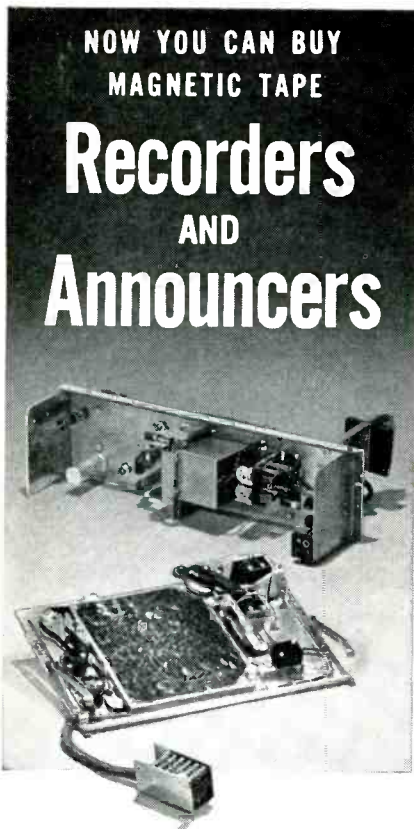

designed for industrial applications and made by **STROMBERG-CARLSON**

When you learn what telephone companies do with these products, a dozen applications to *your* problem will come to mind.

The XY Tape Recorder is used in connection with long-distance telephone calls for recording data on a sequential basis, and later reading out the information at very high speed. Mighty useful in data processing.

The Tape Announcer is used to substitute a pre-recorded message for interception by a telephone operator—in cases like wrong numbers dialed, discontinued numbers and the like. It can be used in conjunction with any communication system.

FREE catalog will be sent on request. Or write us regarding any specific problem you have right now.



**STROMBERG-CARLSON**

A DIVISION OF GENERAL DYNAMICS CORPORATION

TELEPHONE INDUSTRIAL SALES

114 CARLSON ROAD, ROCHESTER 3, N. Y.

Want more information? Use post card on last page.

tions, own speed, enemy's speed, air temperature, altitude, roll and pitch of own ship, trajectory characteristics, etc., are involved and are continuously varying at more than a thousand changes every second. Figure 1 shows the typical

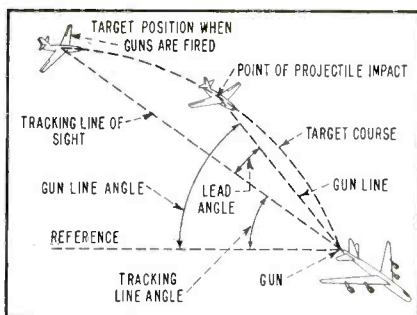

FIG. 1—Basic AA fire control problem

basic fire control problem, while Fig. 2 outlines the system in block form.

► **Safety**—The firing is not automatic. The system is kept under human control so that the gunner

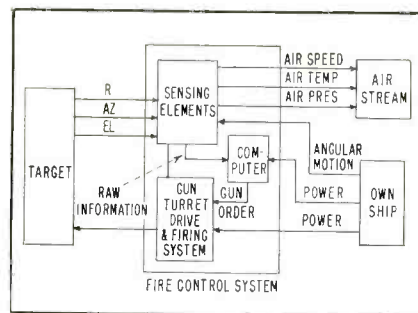
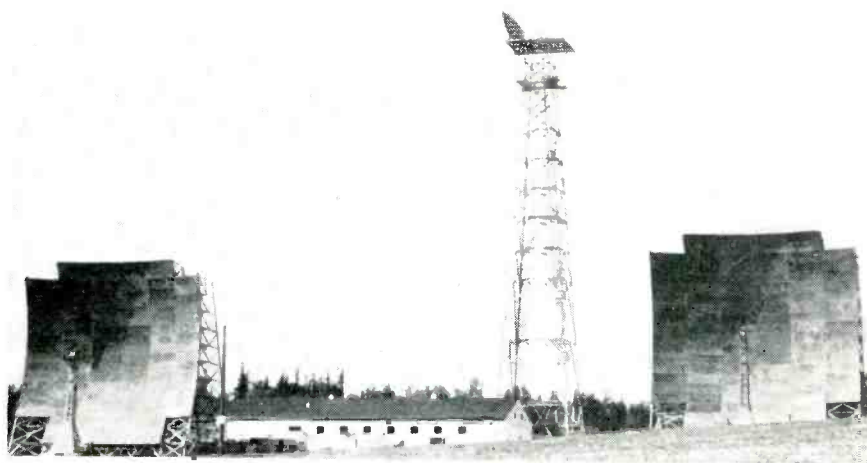

FIG. 2—Block diagram of B-52 defensive system

can instantly override the system at will since the system can not distinguish between friend and foe. This defensive equipment is being produced by Arma.

## White Alice Uses Scatter



First section of White Alice, Alaskan uhf system spanning about 3,300 miles with stations at some 33 sites, to improve communications between DEW line and Alaskan Air Command is scheduled to operate in October. Microwave relay, operating line-of-sight, with towers spaced about 30 miles apart and an over-the-horizon system will transmit the beam in longer jumps of 200 miles across uninhabited wastes. The forward scatter antennas can be seen at either side of the photo. The system will be integrated with government communications systems, CAA, Alaskan Air Command and Alaskan Communications Systems.

## SAGE Air Defense Computer

FIRST production model of IBM's AN/FSQ-7 computer is ready for installation at McGuire Air Force Base, New Jersey. Engineering

prototypes are installed at Kingston and at MIT's Lincoln Laboratory, Lexington, Massachusetts. It consists of 55 oversize cabinets and



# the majority use T/I transistors!

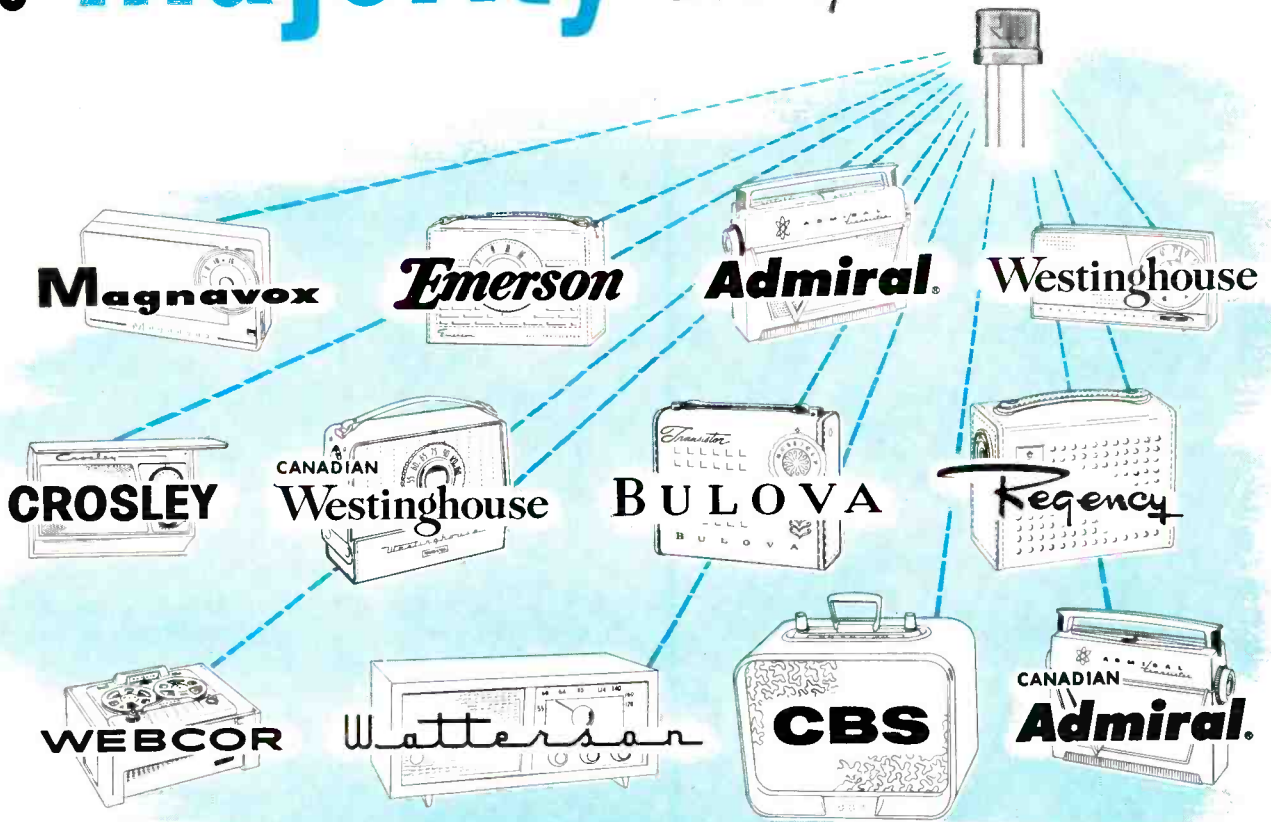

The overwhelming majority of transistORIZED radios — including these and other brands — use Texas Instruments transistors. This is simple proof of TI's leadership in research, development, and manufacture of transistors.

The constantly growing line of economical TI transistors — high in gain, frequency, power, and reliability — offers *your* transistORIZATION program increasing design freedom and flexibility.

**ALL THESE UNITS ARE IN PRODUCTION AND IMMEDIATELY AVAILABLE!**

**VHF GERMANIUM TETRODE** — Maximum oscillation frequency above 250 mc; typical amplifier gain, 12 db at 100 mc. A "grown-diffused" product!

**GERMANIUM POWER TRANSISTOR** — For Class A and B amplifiers; low distortion, linear beta, high current capacity.

**GERMANIUM HF TRANSISTOR** — Converter in 455 kc commercial receivers; conversion gain, 22 db minimum at 1800 kc input.

**GERMANIUM AUDIO OUTPUT TRANSISTOR** — Designed for driver and Class B audio applications; low distortion, linear beta.

**GERMANIUM IF AMPLIFIER TRANSISTORS** — High gain in common emitter applications. In 262 kc and 455 kc types; all with fixed value of neutralizing impedance.

**GENERAL PURPOSE GERMANIUM TRANSISTORS** — Three types for general application; featuring narrow beta spread.

**LOOK TO TI FOR: GERMANIUM VHF, POWER, RADIO, AND GENERAL PURPOSE TRANSISTORS  
SILICON HF, POWER, AND SMALL SIGNAL TRANSISTORS • SILICON DIODES AND RECTIFIERS**

**pioneer producer  
of  
radio transistors!**



**TEXAS INSTRUMENTS  
INCORPORATED**  
6000 LEMMON AVENUE DALLAS 9, TEXAS

# ELECTRONICS ENGINEERS PHYSICISTS

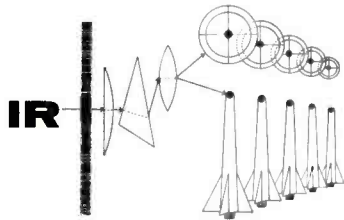

## Infra-Red Is Ultra-Modern

In the post-war years, the development of infra-red devices has attained the dimensions of a technological breakthrough. In this period, the Electronics and Guidance Division of Aerojet-General Corp. has become the national leader in the development and manufacture of infra-red equipment.



Aerojet-General is a vigorous company staffed with men who are enthusiastic about their work and confident of the future. Here are some of the things you might do at Aerojet:

### Electronics Engineers

Design and develop detection, tracking and guidance systems. Design and develop guidance, aircraft search, tracking, communication and gunsight systems.

### Physicists

Investigate special guidance techniques, systems and devices. Conduct studies and experimental work in the field of optics, and infra-red and other types of radiation.

**Aerojet-General**

CORPORATION  
A Subsidiary of THE GENERAL TIRE & RUBBER COMPANY  
AZUSA, CALIFORNIA  
SACRAMENTO, CALIFORNIA

Write: Director of Scientific and Engineering Personnel, Box 296UU, Azusa, Calif.

ELECTRONS AT WORK

(continued)

uses 58,000 electron tubes. The computer consumes one million watts.

► **Purpose**—The AN/FSQ-7 is a duplex computer that receives position and velocity information about intruding aircraft and issues commands to defense facilities. Arithmetic memory and output portions are duplicated to insure uninterrupted operation. However, only one set of input equipment is provided.



Twenty-four magnetic drums provide high speed buffer storage. Drums rotate at 3,000 cps and store 500,000 bits each

Other provisions for reliable operation include marginal checking and diagnostic programming checks. The computer has a basic clock frequency of 2 mc. Internally it operates in the binary mode using 32-bit words.

► **Input**—Radar information is fed to the computer from Navy picket ships, offshore Texas Towers, long-range search radar stations and radar-equipped aircraft on early-warning patrol. This information is transmitted over telephone lines and ultra high-frequency scatter circuits.

The computer likewise receives reports from Ground Observer Corps personnel and from short-range gap-filler radar. The GOC reports are inserted manually into the computer. Gap-filler radar data is received in quantized form over telephone lines and displayed on mapping consoles.

Input to the computer is from phototubes installed over the console screen. The mapping console

operator is thus enabled to mask out irrelevant data.

Other input data such as weather reports and filed flight plans of friendly aircraft are inserted in the computer by punched cards.

► **Memory**—Buffer storage is provided by magnetic drums. Some drum tracks also store information on availability status of defending forces. There are 24 magnetic drums in all—12 for each half of the duplex computer.

The drums rotate at 3,000 rpm and are 10 in. in diameter by 12 in. long. Each drum stores 500,000 bits. Program storage is provided by eight magnetic-tape-handling units—four for each half of the computer.

High-speed internal storage uses two ferrite-core magnetic memories. Each core memory stores more than 500,000 bits. The core memory operates in the parallel-broadside information transfer mode and provides 6-microsecond access time. Also used are more than 20,000 tape-wound cores that comprise the computer's magnetic shift registers.

► **Output**—The computer transmits target information to antiaircraft and guided-missile batteries. Course information is relayed to defending interceptor aircraft over radio data links.

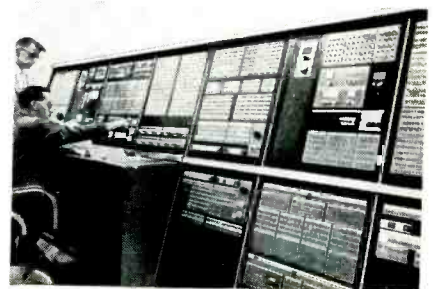

Lamps on operating console show operating status of equipment

In addition to these real-time control signals, the computer provides output data for evaluation or reuse on punched cards.

There is a visual display for personnel at the computer installation. Each display console has one 19-in. Charactron tube and one 3-in. Typotron tube. The Charactron is equipped to display both vectors

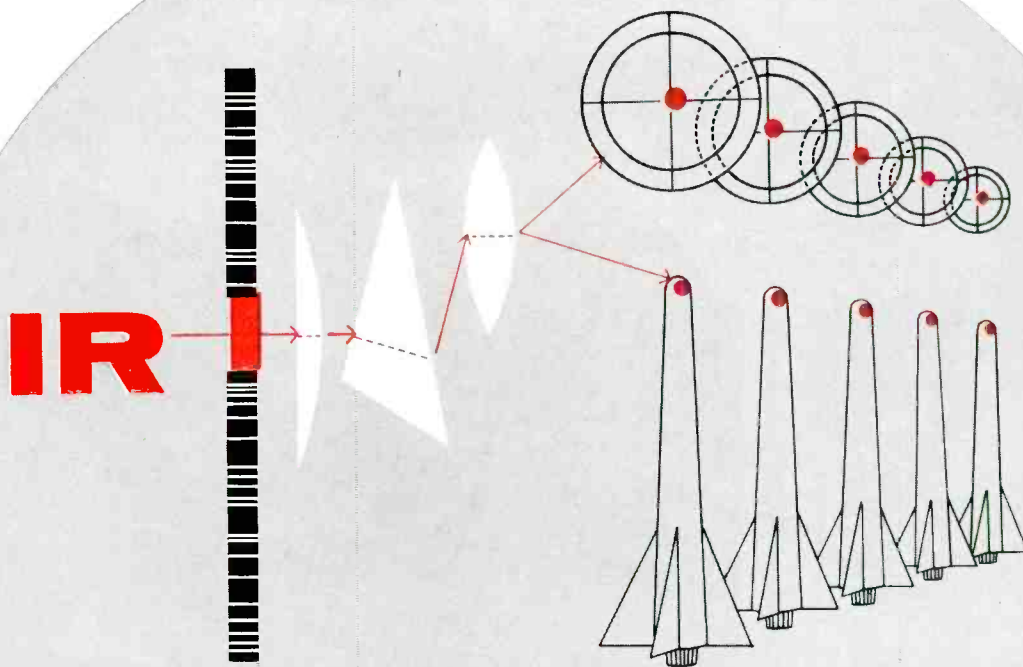

## INFRA-RED

**1944...RESEARCH • 1956...MASS PRODUCTION**

For 13 years Aerojet-General has pioneered the research and development of infra-red devices. Now, Aerojet and Aerojet alone has perfected the high-volume production of infra-red systems for:

GUIDANCE  
WIDE-ANGLE SEARCH  
AUTOMATIC TRACKING  
GUNFIRE CONTROL

*Aerojet-General* CORPORATION

A Subsidiary of  
The General Tire & Rubber Company



AZUSA, CALIFORNIA  
SACRAMENTO, CALIFORNIA

Electronics engineers...physicists... Aerojet invites you to pinpoint your own targets, "lock on" your own future... in the dynamic new field of infra-red.

## PROVEN PERFORMANCE

at elevated temperature ...

a steel ball ...

and a 1,000 gram weight ...

prove that ...

**TEMFLEX\* 105**  
gives you greater resistance to penetration

● In the testing ovens of Irvington's quality control laboratories, the superiority of tough Temflex 105 is proven repeatedly. Weighted, "pressured" with an inserted steel ball that would penetrate older type plastic tubings far sooner, Temflex shows 20% greater strength. Besides passing ASTM D-876 tests, Temflex far surpasses the other requirements of Mil-I-631 C specification. It is QPL approved and has UL approval as a 105° C. tubing. Self-extinguishable, fungus resistant Temflex comes in all standard colors and sizes. Send for samples and literature.

\* Reg. U. S. Pat. Off.

# IRVINGTON

DIVISION

Minnesota Mining and Manufacturing Co.



11 Argyle Terrace, Irvington 11, N. J.

Want more information? Use post card on last page.

and alphanumeric information while the Typotron displays alphanumeric information only.

Identification and weapons-director officers assigned to the visual

display consoles have the responsibility of assigning targets to defending forces. It is this feature of the SAGE system that makes it semiautomatic.—J. M. C.

## Transistors Cut Camera-Chain Size

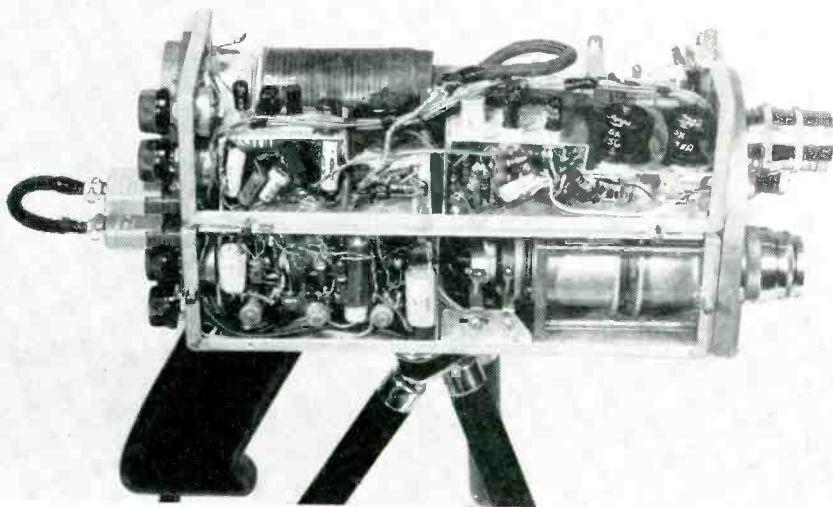

The camera shown above is part of a transistorized chain consisting of a four-pound hand-held camera with a detachable electronic viewfinder and a 15-pound back-pack containing a sync generator, transmitter and power supply. All the circuits, except the transmitter require a total of 70 transistors. The one-half-inch diameter vidicon camera tube provides a standard output signal and feeds a video line directly instead of modulating the built-in transmitter. A cavity-stabilized oscillator operating at 2,000 mc comprises the transmitter, whose power output to the antenna is approximately one-half watt. A highly directive antenna at the receiving station provides an operating range of up to one mile. The equipment operates for five hours on rechargeable silver-cell batteries incorporated in the back-pack. A transistor inverter circuit supplies the high voltage for the transmitting, pickup and monitor tubes.

## Nonmicrophonic Klystron

By R. A. LA PLANTE  
Philips Laboratories  
Irvington-on-Hudson, N. Y.

MICROWAVE tube designers have taken numerous steps to reduce microphonism in klystrons. Where tuning was essential, a compromise usually was made between the resistance of the klystron to microphonism and the ease with which it could be tuned.

This paper describes a high-power two-cavity klystron oscillator and gives the results of measurements that indicate the relation between tunability and microphonism.

Shortly after the development of

the L-cathode, a series of high-power two-cavity klystrons was designed. Power outputs of the klystrons range from 1,200 watts c-w at 10 cm to 100 watts c-w at 3-cm wavelength. The electron beams in these tubes are electrostatically focused. The 3-cm tube, shown in Fig. 1, tunes from 8.5 to 10.5 kmc.

A study was made of the frequency and amplitude fluctuations in the tube's output. From the spectra of the frequency and amplitude modulations, the power

# Los Alamos Secret Disclosed by Tr

# ATOMIC BOMBS DROP ON JA

**Deadliest Weapon in World's History In Santa Fe Vic**

Santa Fe learned officially today of in its own front yard.

The reverberating announcement of bomb, with 2,000 times the power of the Flamers dropped on Germany, also lifts the community on the Fajardo Plateau. Santa Fe has ignored, except in whispers...

**Bradbury Outlines**

...the power of the atomic...

**Peterson Hails Result Of Atomic**

...the power of the atomic...

**Hill Staffers Give Talks At General**

...the power of the atomic...

**Dr. R. C. Smith Names His First Nuclear Test**

...the power of the atomic...

**Strauss**

...the power of the atomic...

**'Dedicated' Hillster Praised By AEC Boss**

...the power of the atomic...

**Ultra-Fast Camera Developed On Hill**

...the power of the atomic...

**Tests Indicate U.S. 'Hell Bomb' Now A Successful Experiment**

...the power of the atomic...

**Now They Can Be Told Aloud, Those Stories of 'the Hill'**

...the power of the atomic...

**Tests Hint H-Bomb**

...the power of the atomic...

**Hill Expert At Test Scene**

...the power of the atomic...

**Smyth Has High Praise For Lab, Direction Of Dr. Bradbury**

...the power of the atomic...

# GRADUATE RESIDENCE CENTER ESTABLISHED AT LOS ALAMOS

Los Alamos Scientific Laboratory has completed arrangements with the University of New Mexico for the establishment of a Graduate Residence Center at Los Alamos. This program will provide the opportunity for employees and residents to meet all of the requirements for the master's degree in the physical sciences and engineering (including Nuclear Engineering) by attendance at evening classes. Some of these courses are taught by Laboratory personnel outstanding in their fields.

In addition, there are extensive course offerings in the undergraduate and technician training fields for those wishing to pursue academic training related to their jobs or for their own development.

Complete information about career opportunities and the academic training programs can be had by writing,

**Director of Scientific Personnel  
Division 1303**

**Los Alamos complete University establish**

...the power of the atomic...

**Personal Citation AEC's Chief**

...the power of the atomic...

**Los Alamos Holds U.S. Safety Key**

...the power of the atomic...

**Speculation Over H**

...the power of the atomic...

**H-Bomb Disclosure Hill During Panel**

...the power of the atomic...

**Third War Editor, Scientists Debate Preparation For New Chaos**

...the power of the atomic...

**Los Alamos Hunting Thing**

...the power of the atomic...

**Los Alamos Scientific Laboratory**  
OF THE UNIVERSITY OF CALIFORNIA  
LOS ALAMOS, NEW MEXICO

# HICKOK

stable  
wide band  
sensitive

## DC OSCILLOSCOPE



ILLUMINATED  
CALIBRATED  
SCREEN

MODEL  
**770**

This new oscilloscope provides wide range in sensitivity and band width with unusual stability.

The wide band width and high sensitivity features quickly identify this 'scope as an unusual value in the medium price class.

### SPECIFICATIONS

**WIDE BAND AMPLIFIER:** Frequency response DC, to 5mc (within 3db).

**VERTICAL DC AND AC AMPLIFIER:** 10 M. V. RMS per inch with band width switch in narrow position. 35 M. V. RMS per inch in wide position. No jitter, even with high gain amplifiers. Maximum Input Potential: 1000 volts peak. Input impedance: 2.2 megohms, 50 mmf.

**FREQUENCY RESPONSE:** 0 to 2,500,000 cycles, 3 db down in narrow position. 0 to 5,000,000 cycles, 3 db down, in wide position. (Better than standard I.R.E. Roll-Off characteristics.)

**HORIZONTAL A.M.P.LIFIER:** Deflection Factor—Full Gain Setting: 75 millivolts RMS per inch. Frequency Response: 0 to 500,000 cycles, 3 db down. Maximum Input Potential: 1000 volts peak. Input Impedance: 2.2 megohms, 50 mmf.

**BUILT-IN CALIBRATING VOLTAGES:** Peak-to-Peak; 100, 10, 1, .01 volts.

**TEST SIGNALS:** Line Frequency: 3 volts RMS per inch. Sawtooth: Available from front panel. Direct connection to both horizontal and vertical deflection plates.

**ILLUMINATED, CALIBRATED SCREEN:** Backed with a green filter, reduces reflections from incidental illumination.

**LINEAR TIME BASE:** Recurrent and Driven Sweep: 2 cycles to 30,000 cycles. Provision for external capacities for slower frequency sweeps of 10 seconds and slower. Sweep Speeds: Faster than 0.75 inch per micro-second. Fixed frequencies: 30 and 7,875.

**"Z" AXIS MODULATION:** Capacitively coupled to the grid of the cathode ray tube. 2 volts peak-to-peak will blank trace fully at normal intensity.

**INTENSITY:** Standard Model 770 includes 5AB1 cathode ray tube with medium persistence screen. High accelerating potentials give excellent intensity for viewing transient waves and high frequencies. Short persistence or long persistence tubes are available.

**New Flat-Face Tube** allows a more linear reading and facilitates photography of patterns. Other features include unusual stability; 6x expandable sweep; line frequency phasing; shielded and shock mounted construction.

spectrum of the klystron was calculated. It was expected that the power spectrum would be broadened by frequency and amplitude fluctuations associated with the interaction of the electron beam with the cavities. These fluctuations are called electronic noise.

Difficulties were encountered in trying to make measurements of the electronic noise of the klystrons because they were microphonic. When a klystron is microphonic, it exhibits a broad power spectrum even without deliberately vibrating the tube. The contribution to the broadness of the spectrum by electronic noise is very small. To reduce noise in the klystrons, it is then essential to reduce the microphonics.

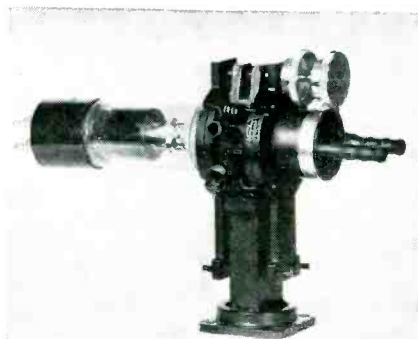

FIG. 1—Tunable klystron uses L-type cathode

An experiment was conducted to illustrate the relation between microphonism, the power spectrum and tunability. A klystron whose power spectrum had been measured was cast in plaster of Paris to simulate a stiffening of the tuner parts and a measurement of its power spectrum was made.

Later the plaster was removed and the tube was cast permanently in a plastic resin. In each case the cast tube was no longer tunable. Figure 2 shows the reduction in the width of the power spectrum with these two steps from 5.3 to 0.2 kc.

Another klystron was built that has no tuner. No mechanical adjustments are required to operate the tube and it is extremely non-microphonic. The power spectrum of this tube is so narrow that it cannot be measured reliably be-

THE HICKOK ELECTRICAL  
INSTRUMENT COMPANY

10527 Dupont Avenue  
Cleveland 8, Ohio

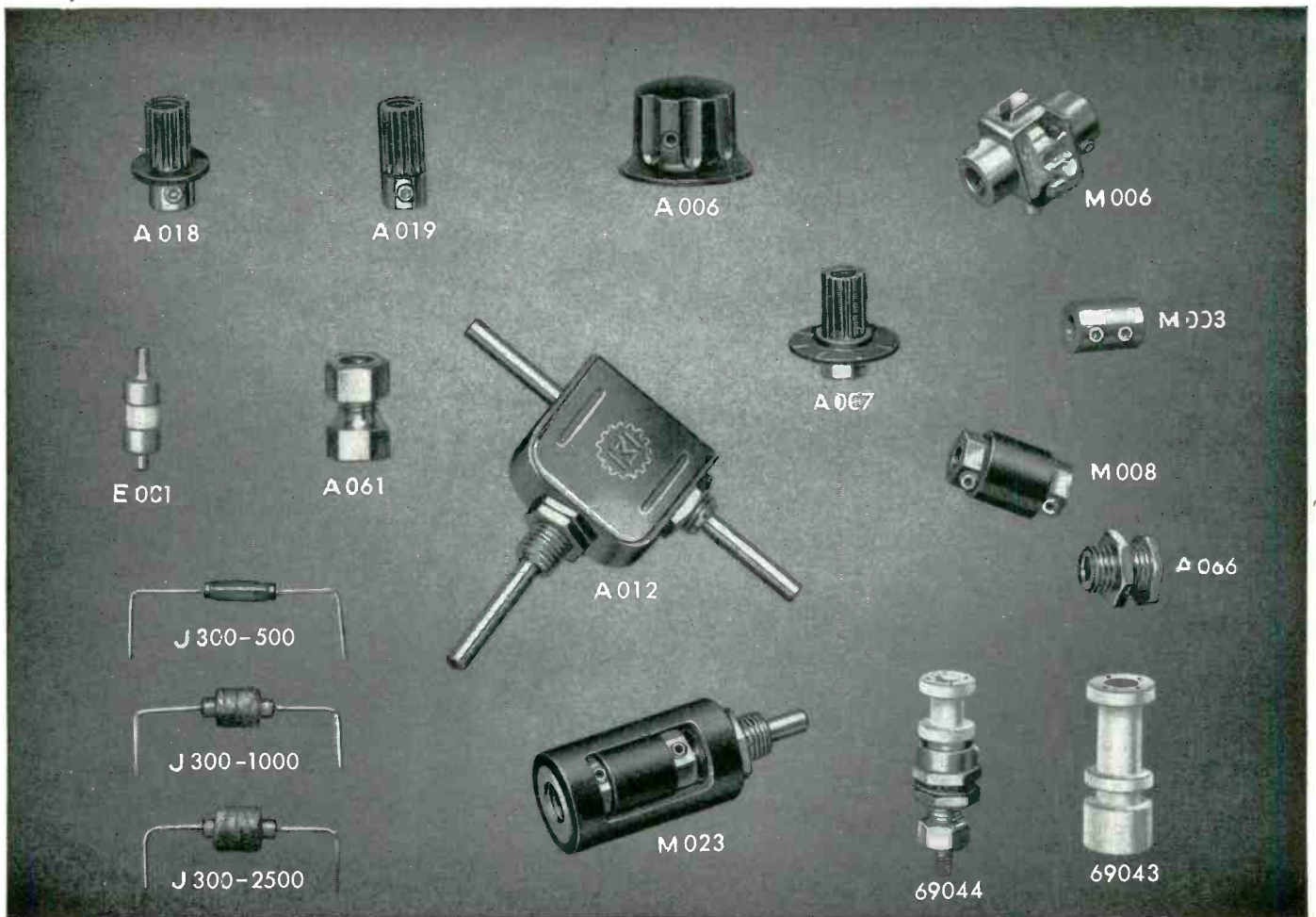

## MINIATURIZED COMPONENTS

DESIGNED for APPLICATION miniaturized components developed for use in our own equipment such as the 90901 Oscilloscope, are now available for separate sale. Many of these parts are similar in most details except size with their equivalents in our standard component parts group and in certain devices where complete miniaturization is not paramount, a combination of standard and miniature components may possibly be used to advantage. For convenience, we have also listed on this page the extremely small sized coil forms from our standard catalogue. Additional miniature and subminiature components are in process of design and will be announced shortly.

CODE	DESCRIPTION	NET PRICE
A006	Matches standard knobs in style. Black plastic with brass insert. For $\frac{1}{8}$ " shaft. Overall height $\frac{1}{2}$ ". Diameter $\frac{3}{4}$ ".	\$ .42
A007	Same as A018 except for $\frac{3}{8}$ " diameter plastic dial with 5 index lines.	.48
A012	Right angle drive. $\frac{1}{8}$ " diameter shafts. Single hole mounting bushing $\frac{1}{4}$ "-32 diameter.	3.90
A018	$\frac{1}{8}$ " diameter black plastic knob with brass insert for $\frac{1}{8}$ " shaft. Skirt diameter $\frac{3}{8}$ ". Overall height $\frac{5}{8}$ ". Unique design has screwdriver slot in top.	.39

CODE	DESCRIPTION	NET PRICE
A019	Similar to A018, but without flange.	\$.36
A061	Shaft lock for $\frac{1}{8}$ " diameter shaft. $\frac{1}{4}$ "-32 bushing. Nickel plated brass.	.39
A066	Shaft bearing for $\frac{1}{8}$ " diameter shafts. Nickel plated brass. Fits $\frac{1}{8}$ " diameter hole.	.36
E001	Steatite standoff or tie-point integral mounting eyelet. .205 overall diameter. Box of five.	.90
J300-500	Iron core RF choke 500 uh.	.42
J300-1000	Iron core RF choke 1000 uh.	.42
J300-2500	Iron core RF choke 2 $\frac{1}{2}$ mh.	.42
M003	Solid coupling for $\frac{1}{8}$ " diameter shaft. Nickel plated brass.	.30
M006	Universal joint style flexible coupling. Spring finger. Steatite insulation. Nickel plated brass for $\frac{1}{8}$ " diameter shafts.	.75
M008	Insulated coupling, with nickel plated brass inserts for $\frac{1}{8}$ " diameter shafts.	.48
M023	Insulated shaft extension for mounting sub miniature potentiometer with $\frac{1}{8}$ " diameter shafts and $\frac{1}{4}$ "-32 bushing.	1.35
69043	Steatite coil form. Adjustable core. Top tuned. Tapped 4-40 hole in case for mounting. Winding space $\frac{1}{4}$ " diameter $\pm$ $\frac{1}{32}$ " length.	.84
69044	Steatite coil form. Adjustable brass core. Bottom tuned. Mounting by No. 1D-32 brass base. Winding space .187 diameter by $\frac{3}{16}$ " length.	.84

JAMES MILLEN

MAIN OFFICE



MFG. CO., INC.

AND FACTORY

MALDEN, MASSACHUSETTS, U. S. A.

# tree chart

## 14 properties of 25 Dielectric Materials

**MECHANICAL & ELECTRICAL CHARACTERISTICS OF DIELECTRIC MATERIALS**

For numerical values in SI reference to dielectric materials in dielectrics.

Material	Specific Gravity	Tensile Strength (lb/in <sup>2</sup> )	Compressive Strength (lb/in <sup>2</sup> )	Flexural Strength (lb/in <sup>2</sup> )	Impact Strength (ft-lb/in <sup>2</sup> )	Max. Operating Temperature (°C)	Volume Resistance (ohm-cm)	Dielectric Strength (V/mil)	Dielectric Constant (at 100 cycles/sec)	Power Factor (at 100 cycles/sec)	Water Absorption (100% at 24 hrs)	Art. Resistor (1000 cycles)	Loss Factor (1000 cycles)	Shrinkage (1000 cycles)
1. Teflon	2.1	3,000	75,000	20,000	4.0	350° F	10 <sup>14</sup>	450	2.0	0.002	0.01%	500	0.001	—
2. Fibreglas, Molded	1.96	8,000	20,000	9,000	3.0	300° F	10 <sup>14</sup>	250	6.5	0.02	0.1%	60	0.12	302
3. Bakelite, General Purpose	1.35	8,500	20,000	8,700	3.4	325° F	10 <sup>14</sup>	300	5.0	0.05	0.6%	3.0	0.03	0.63
4. Mica, High Purity	1.85	4,500	20,000	9,000	3.5	325° F	10 <sup>14</sup>	10 <sup>14</sup>	300	0.005	0.01%	1.8	0.009	0.63
5. Resin, 3700	1.7	4,500	20,000	9,000	3.5	325° F	10 <sup>14</sup>	10 <sup>14</sup>	300	0.005	0.01%	1.8	0.009	0.63
6. Ethylene A	1.05	8,000	10,000	10,000	3.5	185° F	10 <sup>14</sup>	400	2.5	0.008	0.05%	60	0.01	—
7. Polyethylene 1-009	2.6	8,500	75,000	14,000	3.5	185° F	10 <sup>14</sup>	400	2.5	0.008	0.05%	75	0.1	—
8. Ceramic, Strainite 1-183	1.04	8,000	14,000	14,000	3.5	385° F	10 <sup>14</sup>	275	3.75	0.005	0.05%	100	0.01	—
9. Styramic, Resinite 1472	1.45	8,500	25,000	6,000	3.0	250° F	10 <sup>14</sup>	500	4.0	0.006	0.05%	500	0.02	—
10. Melamine, BDA	1.39	7,800	60,000	12,000	1.0	300° F	10 <sup>14</sup>	380	3.4	0.04	1.9%	140	0.14	—
11. High Temperature Polyethylene, Super Dylon	2.6	10,000	13,000	13,800	3.0	300° F	10 <sup>14</sup>	350	6.75	0.03	0.04%	130	0.03	—
12. Sintered Glass	1.14	11,000	—	—	3.0	395° F	10 <sup>14</sup>	350	6.0	0.05	0.05%	115	0.02	—
13. Nylon, Molded	1.0	2,000	20,000	9,000	1.2	385° F	10 <sup>14</sup>	300	4.15	0.08	0.2%	350	0.02	—
Waxes	1.95	1,000	25,000	8,500	3.5	300° F	10 <sup>14</sup>	400	—	—	—	126	0.02	—

YOU WILL WANT for your reference files this AMPHENOL listing of the Mechanical and Electrical Characteristics of Dielectric Materials, which compares in handy chart form many of the dielectric materials listed in this issue of *Electronics*.

Send the coupon below.



### ELECTRONIC COMPONENTS

THE LARGEST SELECTION of electronic components in the world can be obtained from AMPHENOL. Standard, miniature and subminiature electrical and radio frequency connectors and cable; plugs and sockets; hermetic seal connectors and headers; printed circuit receptacles; rack & panel connectors of every description; whatever the need, specify AMPHENOL!

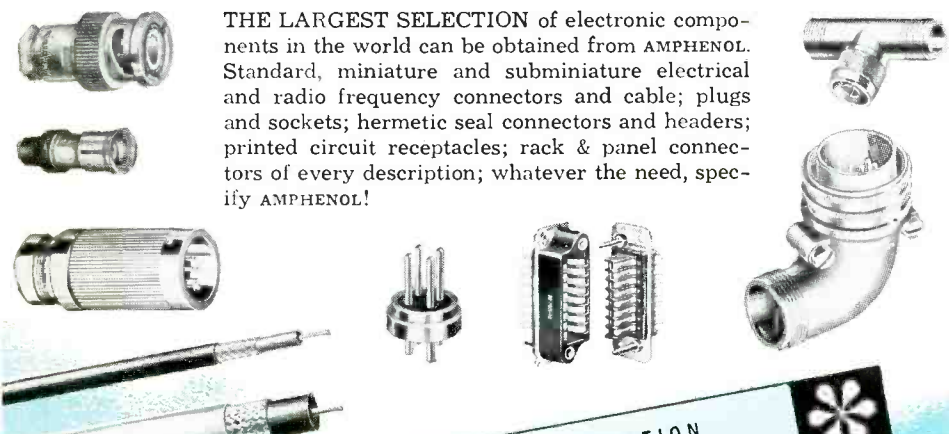

AMPHENOL ELECTRONICS CORPORATION  
1830 South 54th Avenue • Chicago 50, Illinois

Send me the Dielectric Chart

Send me information on these AMPHENOL components:

NAME \_\_\_\_\_ TITLE \_\_\_\_\_

DEPARTMENT \_\_\_\_\_

COMPANY \_\_\_\_\_ ZONE \_\_\_\_\_

ADDRESS \_\_\_\_\_ CITY \_\_\_\_\_ STATE \_\_\_\_\_

cause of the microphonism of the measuring system. The spectral line width is estimated at 0.02 kc or less.

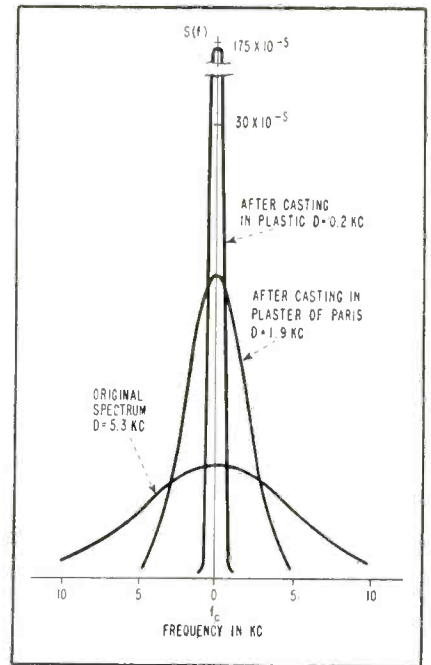

FIG. 2—Spectra of three types of tubes show how frequency width is reduced by eliminating mechanical vibration

Solution of the noise problem would seem to have created a tuning problem because the new tube is a single-frequency source. A number of the applications for high-power klystrons, however, do

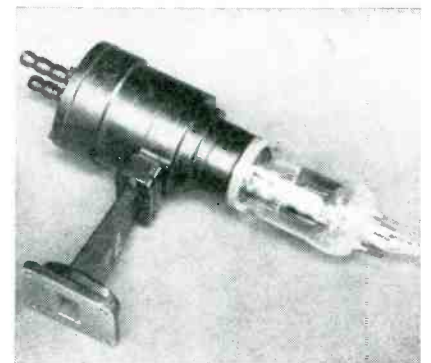

FIG. 3—Fixed-frequency klystron cast in plastic

not require any tuning. Many others require only a special kind of tuning by which the frequency of the transmitter can be changed abruptly from one particular frequency to another.

The compact structure of the



MEMO

TO *Engineering Dept.*

SUBJECT  
**MINIATURE SENSITIVE  
RELAY (TYPE MS)**

(IDEAL FOR PRINTED CIRCUITS)

*Note desired RBM  
features will cut our  
assembly costs*  
*M. S.*

*Self locking  
Terminal position  
Relay before  
Soldering*

*X-Bar Contacts  
insure ultimate  
in Circuit Switching  
Reliability*

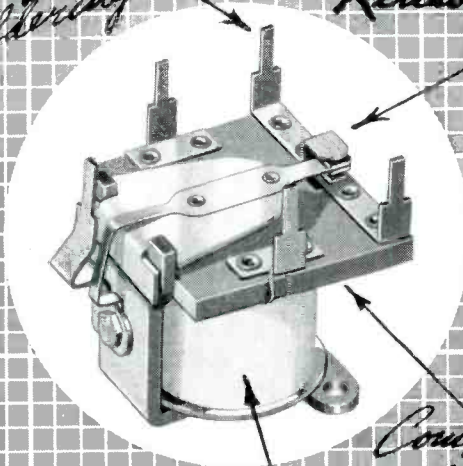

*Compact  
size*

*Coil Construction  
meets unusual  
climatic conditions*

**Construction**—Printed circuit terminals are designed with snap-in feature which holds relay in printed circuit board without lugging prior to solder dip.

Other versions of MS relay available with standard solder type terminals and insulating base, where required. Also with 4 N.O. isolated circuits having common make.

While not yet in production, extra-sensitive version has been developed. Maximum coil resistance 18,000 ohms, nominal sensitivity .030 watt, maximum sensitivity .020 watt, overall height 1-9/16". All other details same as standard MS relay.

**Application**—Type MS is an ideal relay for any application requiring a compact, highly reliable single pole D. C. device, where a low cost solution is required because of volume usage and competitive problems.

The fact that industry has already used over a million units of this design is your assurance that the R-B-M Type MS relay will meet your most exacting requirements.

Contacts used in Type MS are of the cross bar type, which offer the ultimate in reliability throughout the life of the relay. Molded bobbin design has eliminated coil failure on sensitive applications under severe climatic conditions.

**OTHER VERSIONS**

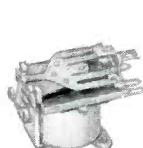

**SOLDER TERMINALS**  
4 isolated circuits with common make contact.

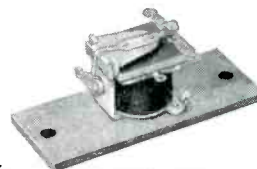

**INSULATED BASE**  
Solder terminals mounted on insulating base.



**EXTRA SENSITIVE VERSION**

**ENGINEERING DATA**

ENGINEERING DATA	
Specifications	Miniature Sensitive Relay Type MS
Contact Form	S. P. D. T.
Contact Rating	1 amp. 32 V.D.C. non-inductive
Coil Resistance	Up to 10,000 ohms
Nominal Sensitivity (Coil Input)	.060 Watt
Maximum Sensitivity	.040 Watt
Approx. Dimensions	1 1/8 x 1 1/8 x 1 1/2"

-  CORD SETS
  -  WIRE HARNESSSES
  -  MAGNET WIRE
- OTHER PRODUCTS



Send for Descriptive Bulletin MS-1

**RBM DIVISION**  
ESSEX WIRE CORPORATION, Logansport, Indiana



A design which uses air as major insulation, with leakage path lengthened by forming porcelain into a bowl, eliminates losses which occur in ordinary types of bushings at radio frequency.

Lapp moderate duty insulators, suitable for a variety of low or medium voltage applications, are the standard type bowls for carrying leads through shields, equipment cases, walls, etc., and practically any indoor use where duty is not too severe.

Outdoor units are designed with corrugated surfaces which provide extra leakage distance for use in contaminated atmosphere. Corrosion-resistant hardware.

A wide variety of types of these insulators is now available as catalog items . . . or where requirements necessitate, on special design—for which Lapp engineering and production facilities are excellently qualified. Write for complete descriptive data and specifications. Lapp Insulator Co., Inc., Radio Specialties Division, 905 Sumner Street, Le Roy, N. Y.



# Lapp

tube shown in Fig. 3 provides greater thermal stability because the cavities are kept more nearly at the same temperature. Cooled by water from a municipal supply, it has a frequency drift over 8 hours of less than 0.3 mc. With some control of coolant temperature this drift could be further reduced.

Such klystrons can be made at 5-watt levels or 200-watt levels with the same construction. Oscillating frequency can be preset to within  $\pm 5$  mc of any desired frequency in the X band, and when the tube is excited, it always goes into oscillation at its preset frequency.



FIG. 4—Coolant and waveguide connections allow fixed-frequency klystron to be quickly replaced for frequency shift

Frequency of operation can be altered by changing tubes as quickly as a tunable tube can be tuned to a desired frequency. This is particularly true when the tunable tube is nonmicrophonic because these types are generally more difficult to tune. Frequency

## Voltage Tunable Magnetron



Recently announced by GE engineers, the new magnetron shown both in cutaway and laboratory prototype versions can be used either as a tunable c-w or f-m source. A control electrode permits a-m or pulse modulation

Precision Instruments...

backed by the

RCA reputation

for engineering

excellence



Precision Impedance Bridge  
Type LB-52

\$585.00\*

# Precision Impedance Bridge

Now . . . From RCA . . . One of the Most Versatile  
Impedance Bridges In Its Price Class

Incorporates these important advances: A metered variable DC source of voltage and current. AC detection for all measurements including DC measurements via "magic eye" null indicator. Provisions for use of external standards. Measures resistance, capacity, inductance, dissipation factor and "Q".

Bridge may be excited: DC, 60 cps or 1000 cps internally; or from 50 to 10,000 cps externally. Such versa-

tility facilitates measurement of incremental inductance and electrolytic capacitors.

A utility impedance bridge available at a lower price.

*RCA Instruments of Laboratory Precision*

PULSE GENERATOR ★ RF POWER METERS ★ NULL VOLT-  
METERS ★ IMPEDANCE BRIDGES ★ SIGNAL GENERATORS ★  
VACUUM TUBE VOLTMETER ★ MULTIMETER ★ CRYSTAL  
MODULATOR AND OTHERS.

\*Price in U.S.A.,  
subject to change  
without notice.



**RADIO CORPORATION of AMERICA**

CAMDEN, N. J.

In Canada: RCA VICTOR Company Limited, Montreal

USE COUPON BELOW FOR COMPLETE INFORMATION

Radio Corporation of America  
Precision Electronic Instruments  
Dept. K-46, Building 15-1, Camden, N. J.

Please send me complete information on the following instruments:

\_\_\_\_\_  
\_\_\_\_\_  
\_\_\_\_\_

Send name of nearest representative

NAME \_\_\_\_\_ TITLE \_\_\_\_\_

COMPANY \_\_\_\_\_

ADDRESS \_\_\_\_\_

CITY \_\_\_\_\_ ZONE \_\_\_\_\_ STATE \_\_\_\_\_

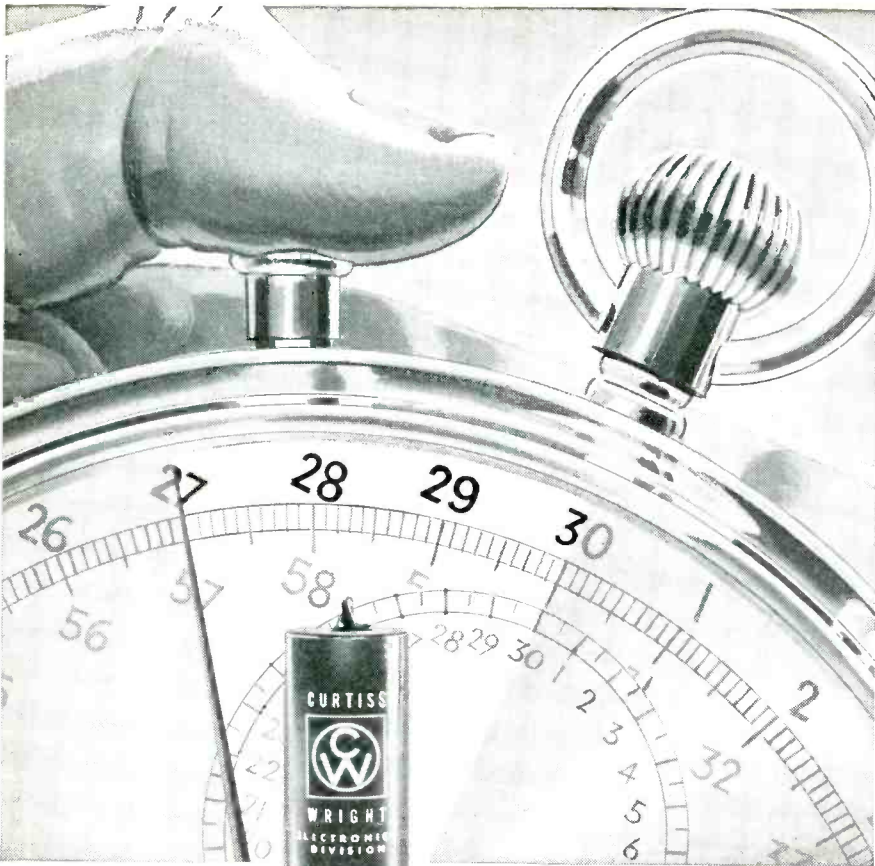

U. S. Pat. No. 2658975

## The Curtiss-Wright "SNAPPER"

NEW CONCEPT...ADVANCED DESIGN  
IN THERMAL TIME DELAY RELAYS

Designed for high performance and long life, the Curtiss-Wright "SNAPPER" Thermal Time Delay Relay is proving itself in countless applications involving time delay in electrical circuits. Such applications include circuits to provide definite on-off time intervals to delay the application of high voltage until after warm-up period and for over and under voltage protection with simultaneous fault indication.

These relays have single-pole double-throw contact action,

high ambient temperature range, freedom from chatter and arcing, and are small in size. The "SNAPPER" thermal time delay relays are factory pre-set from 3 to 120 seconds. They are available in metal envelope, miniature (7 and 9 pin) or octal (8 pin) and in a glass envelope in 9 pin only.

Curtiss-Wright manufactures the High-Low "SNAPPER" Differential Thermostat with high precision characteristics. Write to Thermal Devices for complete information.



and operating potentials can be stamped on the tubes and optimum power output can be assured without monitors.

Problems of coolant and waveguide connections can be overcome in many applications with suitable fittings. Figure 4 shows a klystron equipped with commercial quick-disconnect coolant fittings and a waveguide quick-disconnect.

## Velocity Meter Has Direct Readout

By HOWARD W. SNYDER

*Radiation Laboratory  
Johns Hopkins University  
Baltimore, Md.*

VELOCITY of a moving object of any shape or size can be measured from a low speed of 80 feet per second to over 40,000 feet per second. The range and accuracy is limited only by the spacing of two phototubes and the number of stages in the binary counter.

With a few changes in time constants and mechanical separation, speed can be measured as accurately as desired.

Start and stop multiplier phototubes trigger on and off a variable frequency blocking oscillator whose

## PBX Blind Eye

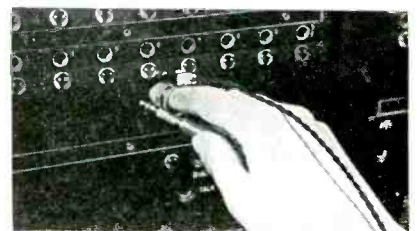

Developmental device built onto a thimble comprises a phototransistor connected through a pair of wires to energize audible signal. It can be used by sightless operators of private branch exchange switchboards to find which line desires service. As the operator moves her finger across a row of lights the photo device picks up the one that is illuminated

**NOW... custom designs  
available in volume!**



**ALSiMAG<sup>®</sup>**

**HIGH TEMPERATURE  
METAL-CERAMIC SEALS**

Outstanding results over wider temperature/frequency ranges. Available for silver solder brazing, hard or soft solder. Rapid, volume delivery of both custom and standard designs from greatly expanded production facilities.

Dependable, permanent bonding . . . close dimensional tolerances . . . strong Alumina

ceramics with extremely low dielectric loss . . . excellent insulation resistance . . . high softening temperature . . . outstanding mechanical and electrical characteristics over entire temperature range . . . improved glaze with superior surface resistivity . . . high tensile and impact strengths . . . greater resistance to chipping and spalling.

To assure optimum performance, American Lava engineers cooperate in establishing proper specifications and configurations on custom designs.

For complete information on ALSiMag Metal-Ceramic Seals for your application—in either high or low temperature fields—send blueprint with your planned installation and operating temperatures, electrical requirements or other pertinent data.

A Subsidiary of  
Minnesota Mining and  
Manufacturing Company



**AMERICAN LAVA  
CORPORATION**

**CHATTANOOGA 5, TENN.**  
55TH YEAR OF CERAMIC LEADERSHIP

For service, contact Minnesota Mining & Manufacturing Co. Offices in these cities (see your local telephone directory): Atlanta, Ga. • Boston: Newton Center, Mass. • Buffalo, N. Y. • Chicago, Ill. • Cincinnati, O. • Cleveland, O. • Dallas, Texas • Detroit, Mich. • High Point, N. C. • Los Angeles, Calif. • New York: Ridgefield, N. J. • Philadelphia, Pa. • Pittsburgh, Pa. • St. Louis, Mo. • St. Paul, Minn. • So. San Francisco, Calif. • Seattle, Wash. Canada: Minnesota Mining & Manufacturing of Canada, Ltd., P. O. Box 757, London, Ont. All other export: Minnesota Mining & Manufacturing Co., International Division, 99 Park Ave., New York, N. Y.



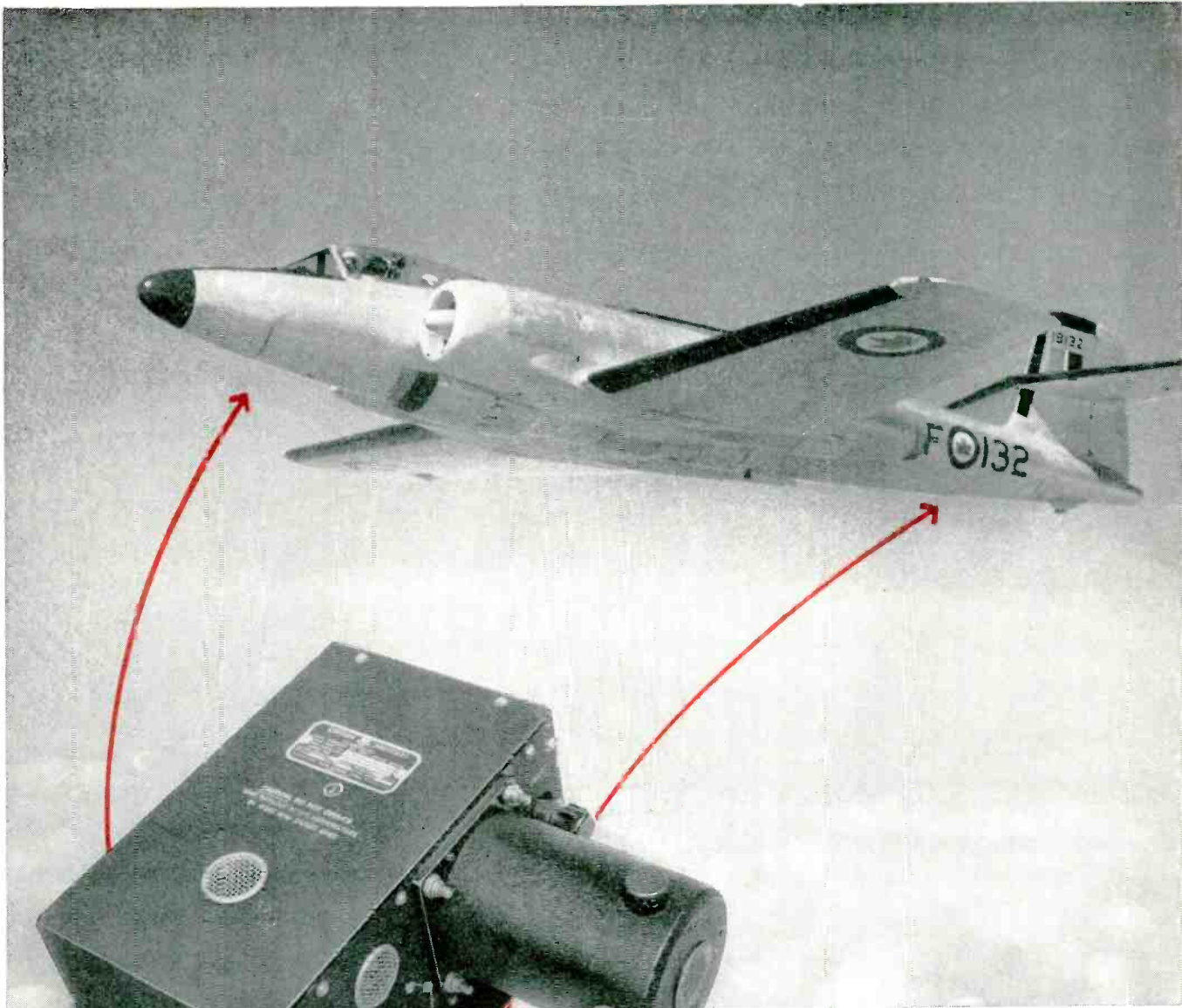

## RELIABLE PRESSURIZATION

for aircraft equipment

The custom job of supplying pressurization units for airborne electronic equipment is Eastern's specialty. Meeting all appropriate government specifications, units can be furnished within the limits shown at right. Dehydrators available. We invite inquiries and specific requests concerning your specifications.

### General Requirements:

*Altitude:* 0-70,000 ft.

*Delivery:* 0-3600 cu.in./min. free delivery

*Discharge Pressure:* 0-60 p.s.i.

*Temperature:* -65°F to +160°F

*Voltages:* any standard voltage.



# EASTERN



**INDUSTRIES, INC.**

100 SKIFF STREET  
HAMDEN 14, CONN.

*New Aviation Products Catalog covering Electronic Tube Cooling Units, Hydraulic Equipment, and Pressurization Units sent on request.*

versatile new

# PENTA PL-172

external anode

1-KW BEAM POWER PENTODE

by use of a calibrated oscilloscope or by checking against a sine or square-wave generator. The pulses are quite sharp, in the order of 0.5 microsecond. Their shape depends primarily on the transformer used and the loading.

The pulse from the phototube triggers a one shot multivibrator in turn triggering a flip-flop circuit. The grid of the gate tube is driven negative releasing the clamp across the blocking oscillator, allowing it to oscillate. The oscillator output is counted by the binary scalers.

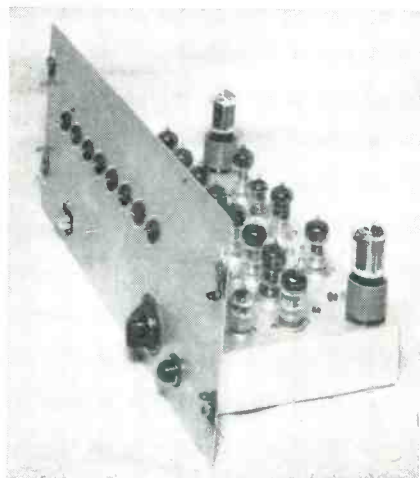

Phototubes are mounted exactly one-foot apart on velocity meter chassis

The sequence is reversed when the gate circuit cuts off the blocking oscillator allowing a count to remain on the indicating lamps. The one-shot multivibrator following the phototubes allows only the leading pulse to come through, eliminating, for example, the pulse created by a discontinuity in the projectile.

A reset switch is provided on the front panel to clear all circuits for the next chain of events. Circuit constants were chosen to minimize any delay in triggering the oscillator and to assure reliable operation. Vacuum-tube diodes are used for the same reason. Care must be taken in choosing parts, as unbalance can cause erratic operation and a variation in sensitivity among stages.

By triggering on the oscillator and viewing its output and that of each scaler, the counter can be checked for proper operation. Each stage doubles in time and can be

new design principle gives extra-high power at low plate voltages

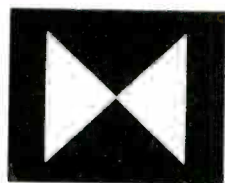
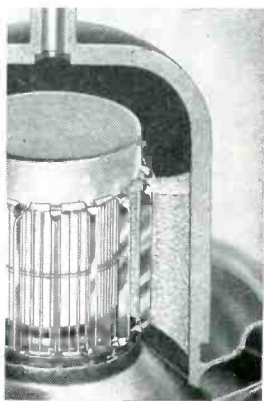

This new pace setter delivers high power at low plate voltage for a variety of r-f and a-f applications. The exceptional performance of the PL-172 is due to the exclusive new suppressor grid vanes which direct electrons to the plate in beams, giving true beam tube characteristics. For critical Class AB<sub>1</sub> linear amplifier applications, for high power audio service, or for high-efficiency, low-drive Class-C use, the PL-172 is a logical choice.

### USE IT AS A CLASS-AB<sub>1</sub> LINEAR R-F AMPLIFIER—

Delivers over 1000 watts useful output at only 2000 plate volts, over 1500 watts at maximum ratings.

### AS A CLASS-C AMPLIFIER—

Over 2000 watts useful output at high efficiency. Driving power less than 5 watts.

### OR AS A CLASS AB<sub>1</sub> AUDIO AMPLIFIER—

Over 1200 watts per pair at 1500 volts. Up to 3000 watts at maximum ratings. Low output impedance simplifies output transformer problems.

### RATINGS

Heater Voltage . . . . . 6.0 volts  
Heater Current . . . . . 7.5 amperes  
Plate voltage, max. . . . . 3000 volts

Plate current, max. . . . . 1.0 amperes  
Plate dissipation, max. . . . . 1000 watts  
Transconductance . . . . . 21,000  $\mu$ mhos

### A COMPLETE LINE OF HIGH-EFFICIENCY POWER TUBES

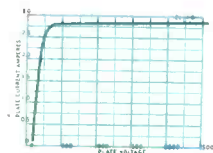

Plate current curve at zero grid voltage shows why the PL-172 gives high power gain and operates efficiently at low voltages.

Write for complete technical data and suggested operating conditions. Representatives in principal cities.



**PENTA** laboratories, inc.

316 N. Nopal St., Santa Barbara, Calif.



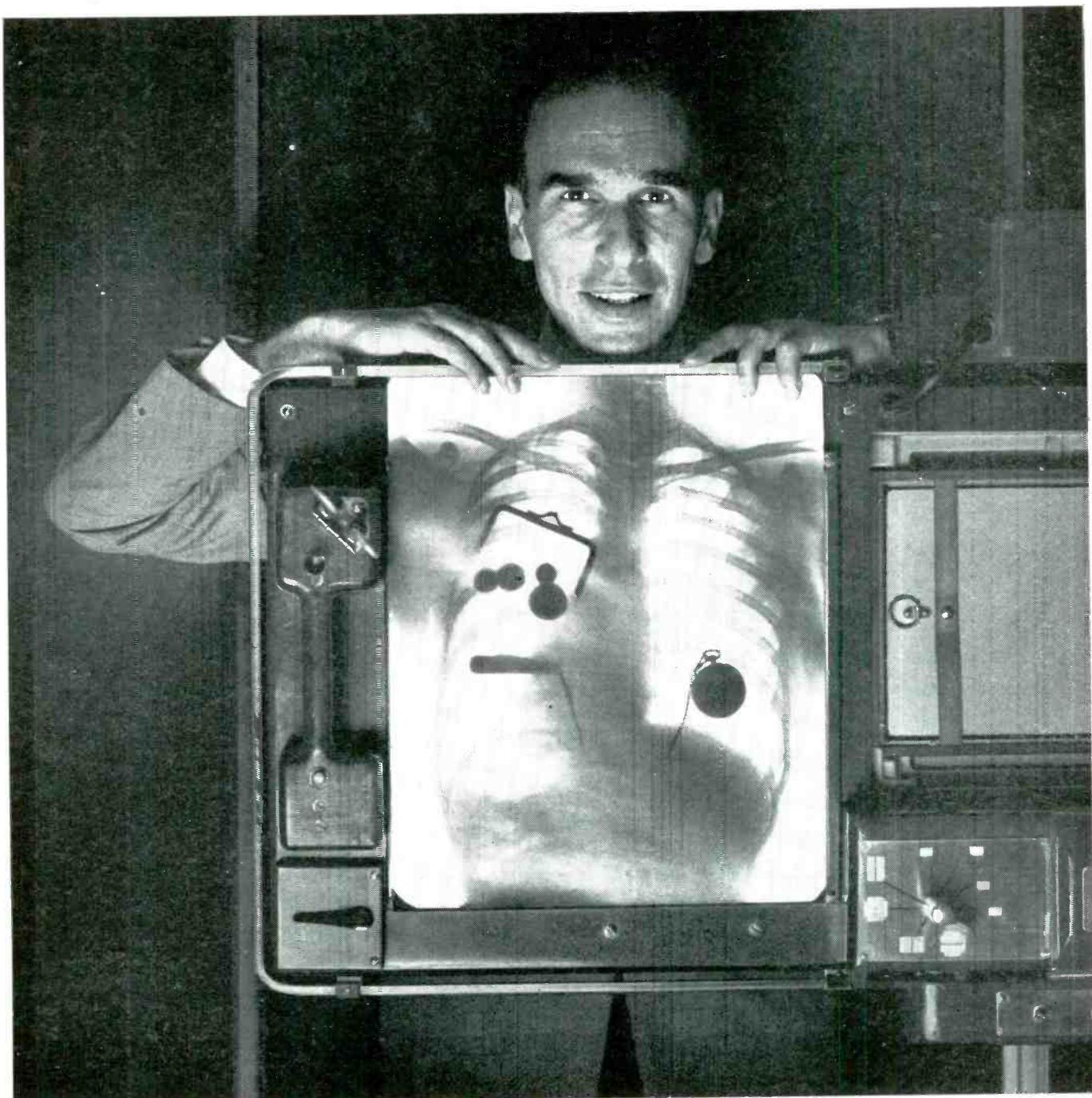

Harvey Picker, President of Picker X-Ray Corp., says:

## “Here’s an inside story on Picker X-Ray!”

“You’re looking into two important ingredients of Picker success — time and money.

“Time is essential when a hospital’s X-ray equipment needs a replacement part. There are thousands of parts which no one could afford to stock-pile everywhere in the country.

“What happens? They call the nearest Picker office and the order is relayed to Cleveland, our manufacturing center.

Whatever’s needed always gets there — and fast!

“How? By Air Express!

“But still, money is a consideration. With Air Express service — including delivery to the door — most of our shipments cost less than any other air service. 15 lbs., for instance, Cleveland to Milwaukee is \$3.23. It’s the lowest-priced complete air-shipping service by \$4.02!”



# Air Express



GETS THERE FIRST via U.S. Scheduled Airlines

CALL AIR EXPRESS . . . division of RAILWAY EXPRESS AGENCY

# BUDD • STANLEY

offers two outstanding services in microwave transmission components!

- ① Exclusive new casting process now produces waveguide assemblies without machining and brazing.
- ② RF heads complete with electron tubes and all accessories fully tested to your specifications and ready for installation in your system.

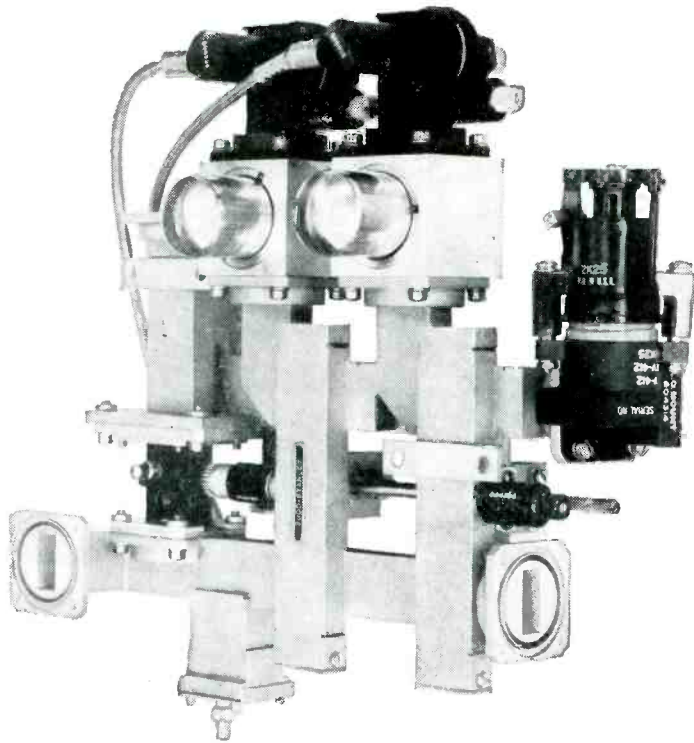

RF HEAD (cast section shown unpainted)

You can depend on Budd•Stanley engineering know-how, manufacturing methods and experience to produce microwave transmission equipment to your specific requirements.

Write for booklet "Additional Facts about the Budd•Stanley Casting Process".

**BUDD • STANLEY CO. INC.**

43-01 22nd St., Long Island City 1, N. Y.  
Phone STillwell 6-1706  
Cable Address "BUDDSTAN"



Quality • Economy • Dependability

easily seen. If a scaler locks on the previous scaler's frequency, or if it does not fire, tubes should be changed and components checked. If this fails, the coupling capacitors should be varied, since either too much or too little trigger pulse can cause improper operation of the counter. These same things are true for all the pulse circuits and should not be overlooked.

One requirement is that the two phototubes see nothing but well filtered light. If used indoors this means a d-c light source or better yet outdoors with natural daylight. The phototubes should have their horizontal view restricted to a narrow field and both treated alike. If a spacing of 12-in. is used the tubes can be mounted on each rear corner of the chassis and look through a slit in the rear of the cabinet. If a greater separation is desired the off tube could be mounted in a separate light-tight box connected by a cable to the chassis.

Sensitivity is high and a very small amount of light and interruption is needed.

## Helmholtz Coil Tests Magnetic Flow Meters

By G. E. WETMORE  
*Electronic Instruments Div.  
The Foxboro Company  
Foxboro, Mass.*

IN PRODUCTION of a new magnetic flow meter, calibration procedures and special production equipment of a type not commercially available had to be designed.

The magnetic meter is based on Faraday's law of electromagnetic induction, which states that the voltage generated in a moving conductor passing through a magnetic field is equivalent to the product of the magnetic field density, the effective length of the conductor and the velocity of its travel.

The magnetic flow meter design consists of a transmitter, which is inserted in the flow line and connected to a receiving instrument. The transmitter generates a voltage proportional to volume rate of

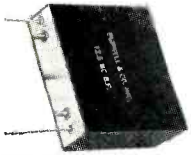

#### SUBMINIATURE FILTERS

- for I.F. amplifiers, printed circuit use
- temperature compensated to .15% from  $-55^{\circ}\text{C}$  to  $+85^{\circ}\text{C}$
- for operations above 1 mc
- dimensions:  $13/16'' \times 2-1/2'' \times 2''$  high



#### ENCAPSULATED TOROIDS

- hermetically sealed
- high Q
- center-mounting permits stacking
- complete range of sizes and types
- dimensions:  $21/32'' \times 3/8''$



#### TOM THUMB TELEMETERING FILTERS

- miniaturized for guided missiles
- high temperature stability
- designed to withstand shock and vibration
- hermetically sealed —wt. 1.5 oz.
- dimensions:  $45/64'' \times 45/64'' \times 2''$  high



#### SUBMINIATURE ADJUSTOROIDS

- precise continuous adjustment of inductance over a 10% range
- no external control current needed
- hermetically sealed
- low cost—wt. .83 oz.
- dimensions:  $45/64'' \times 45/64'' \times 3/4''$  high

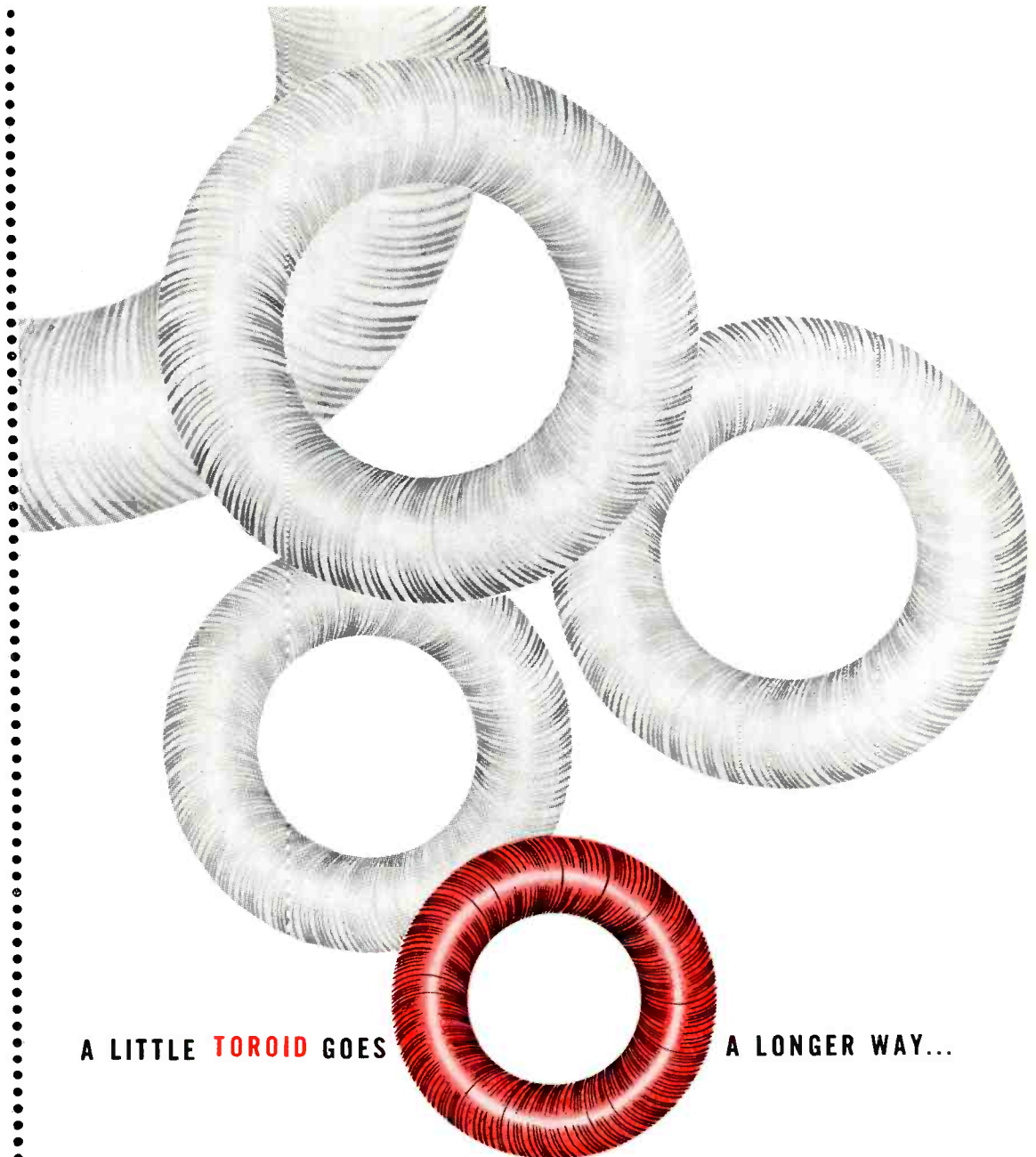

A LITTLE TOROID GOES

A LONGER WAY...

As the toroid shrinks — it expands.

The smaller and more accurate Burnell succeeds in making toroids the wider the applications they continue to find . . . In subminiature filters for aircraft and guided missiles. In communications filters for receivers. In side-band filters for carriers. In filters for telemetering systems. And in an array of other new and remarkably specialized equipment.

Burnell files contain thousands of special designs in subminiature components. If the one you need is not already among them—we will make it for you. Consult us on any network problem. Write today to:—

*Burnell & Co., Inc.*



first in toroids, filters and related networks

45 WARBURTON AVENUE, YONKERS 2, N. Y. TELEPHONE: YONKERS 5-6800 TELETYPE: NEW YORK 3633  
PACIFIC DIVISION: 720 MISSION STREET, SOUTH PASADENA, CALIFORNIA TELETYPE: PASADENA 7578

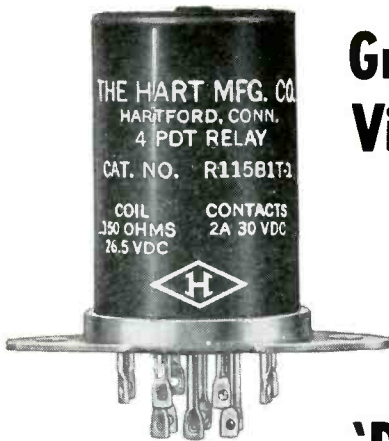

Shown Actual Size

## Greater Sensitivity, Vibration Resistance Engineered in



## 'Diamond H' Relays

Continuing development of "Diamond H" miniature, hermetically sealed, aircraft type relays is constantly widening their performance range. Now, for example, in a 4 PDT relay: sensitivity to 85 mw with vibration resistance of 500 cycles at 10 "G" and 30 "G" shock resistance; vibration resistance of 55 to 2,000 cycles at 20 "G" with 50 "G" shock resistance and maximum sensitivity of 1½ watts.

Excellent contact reliability makes "Diamond H" relays preferred choice for critical jobs in vital applications ranging from guided missiles to high speed camera equipment.

### TYPICAL PERFORMANCE CHARACTERISTICS

<b>Vibration Resistance:</b>	10-55 cycles at 1/16" double amplitude 55-500 cycles at 15 "G" 55-1,000 cycles at 15 "G" 55-2,000 cycles at 20 "G"
<b>Temperature Range:</b>	-55° to + 85°C. -65° to + 125°C. -65° to + 200°C.
<b>Coils:</b>	Resistances—1 ohm to 50,000 ohms Arrangements—single coil; two independent coils, either or both of which will operate unit
<b>Insulation Resistance:</b>	1,000 megohms at room temperature 100 megohms at 200°C.
<b>Dielectric Strength:</b>	450 to 1,250 V., RMS
<b>Operating Time:</b>	24 V. models 10 ms. or less; dropout less than 3ms.
<b>Contacts:</b>	30V., D.C.; 115V., A.C.; 2, 5, 7½ and 10A., resistive; 2 and 5A. inductive. Minimum 100,000 cycles life. Low interelectrode capacitance — less than 5 mmf. contacts to case; less than 2½ mmf. between contacts. Special Ratings: to 350 V., D.C., 400 MA., or other combinations including very low volt- ages and amperages or amperages to 20.
<b>Operational Shock Resistance:</b>	30, 40 and 50 "G" plus
<b>Mechanical Shock Resistance:</b>	up to 1,000 "G"
<b>Mounting:</b>	9 standard arrangements to meet all needs — plus ceramic plug-in socket.
<b>Size:</b>	1.6 cu. in.
<b>Weight:</b>	4 oz. or less

Call on "Diamond H" engineers to work with you in developing a variation to meet your specific requirements.

**THE HART MANUFACTURING COMPANY**  
202 Bartholomew Avenue, Hartford, Connecticut

flow. This voltage is received by an electronic null-balance recorder.

The transmitter, shown in Fig. 1, consists of a pipe with an electrically insulating lining. Around the pipe is a pair of coils and a magnetic core, arranged to provide a uniform magnetic field through the pipe. Two electrodes are mounted

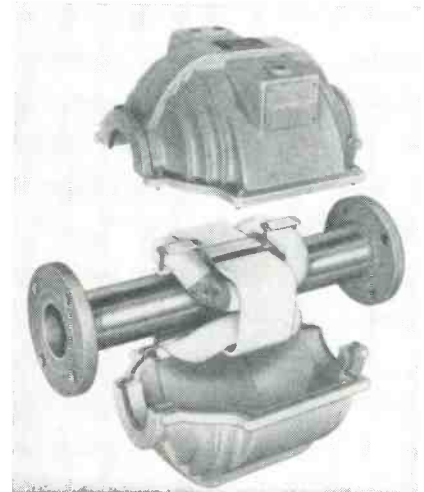
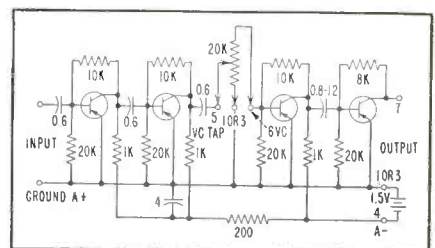

FIG. 1—Transmitter section of magnetic flow meter

opposite each other on the inside wall of the pipe to sense the voltage generated by the flowing liquid.

Once the design was established, problems of calibration had to be solved. Three factors made this step difficult. The allowable error of transmitter and receiver together must not exceed ±1 percent. Calibration should be done at the

### Miniaturized Amplifier



Subminiature four-transistor audio amplifier as shown on cover constructed of special transistors, disk and wafer ceramic capacitors, and printed resistors has a nominal gain of 75 db at 1,000 cps and a signal-to-noise ratio of approximately 38 db. It operates from a supply of 1.5 v at 4 ma, producing 1-mw maximum at 10-percent distortion from 250 to 7,000 cps according to Centralab, its manufacturer

# NEW 10 STAGE $\frac{3}{4}$ " multiplier phototube

*Actual Size*

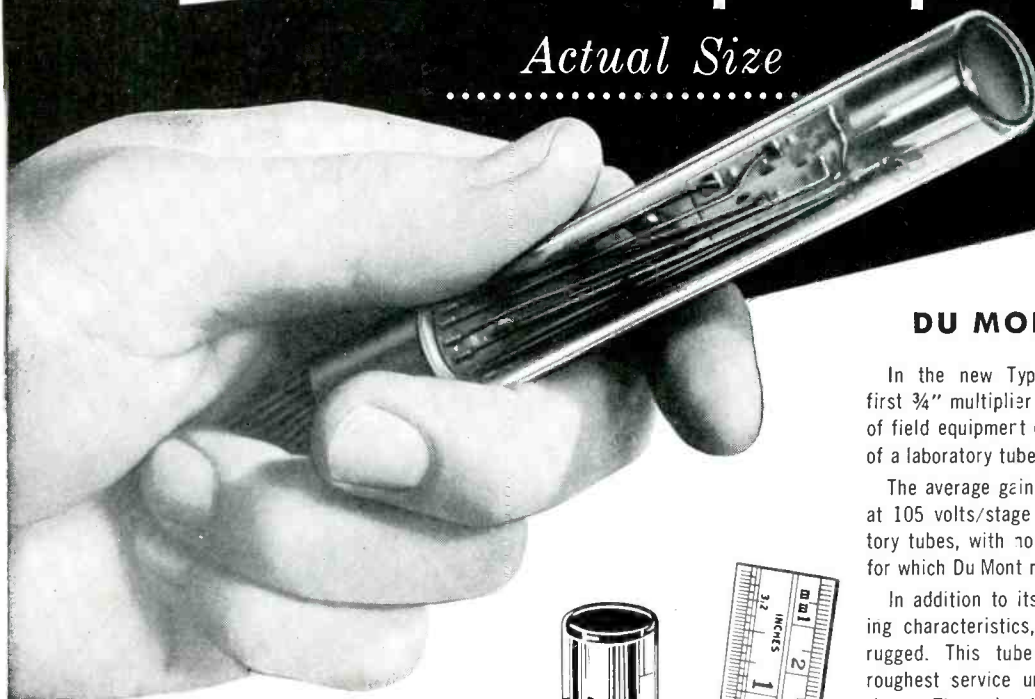

## DU MONT Type K1382

In the new Type K1382, Du Mont offers the first  $\frac{3}{4}$ " multiplier phototube with the ruggedness of field equipment combined with the performance of a laboratory tube.

The average gain of the Type K1382 of 300,000 at 105 volts/stage exceeds that of many laboratory tubes, with no sacrifice in long-term stability for which Du Mont multiplier phototubes are noted.

In addition to its small size and superb operating characteristics, the Type K1382 is unusually rugged. This tube has been designed for the roughest service under the worst climatic conditions. The tube base is potted and all leads jacketed to permit operation under severest humidity without leakage between leads. Laboratory performance can be obtained from this tube even when it is being dropped as a probe into a drill hole far underground.

As in other Du Mont multiplier phototubes, the linear box-type dynode structure is used. This means optimum electron collection greatly improving signal-to-noise ratio. Also, long leakage paths minimize noise and dark current. Dark current is only 0.1 ua at 105 v/stage and 25°C.

The small size and excellent performance of the new Type 1382 mean an extra bonus to users in the geological surveying field where, for example, its extra gain permits much longer signal transmission from underground locations before signal level becomes too low to be useful. It should be exceptionally useful in medical physiological probing. Batteries of these tubes may be used for speedier diagnostic procedure. In addition, the small size will help greatly in the miniature and portable designs that can function at least as well as laboratory equipment.

### CONDENSED SPECIFICATIONS

Average gain:	300,000 at 105 v/stage
Maximum dark current:	0.1 ua max. at 105 v/stage and 25°C
Photocathode sensitivity:	40 ua/lumen
Average anode sensitivity:	12 a/lumen
Maximum outside diameter:	no greater than $\frac{3}{4}$ "
Physical Characteristics:	potted base, jacketed leads

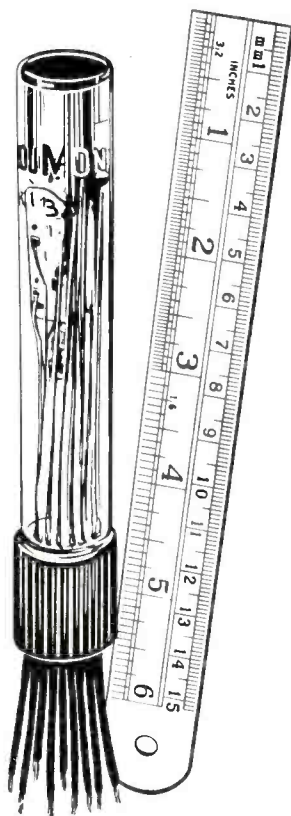

# DU MONT®

For complete information write to:

**Industrial Tube Sales Dept.**

**ALLEN B. DU MONT LABORATORIES, INC.**

**2 Main Ave., Clifton, New Jersey**

# RADIO INTERFERENCE AND FIELD INTENSITY *measuring equipment*

Stoddart equipments are suitable for making interference measurements to one or more of the following specifications:

### AIR FORCE—MIL-I-6181B

150 kc to 1000 mc

### BuAer—MIL-I-6181B

150 kc to 1000 mc

### BuShips—MIL-I-16910A (Ships)

14 kc to 1000 mc

### SIGNAL CORPS—MIL-I-11683A

150 kc to 1000 mc

### SIGNAL CORPS—MIL-S-10379A

150 kc to 1000 mc

The equipments shown cover the frequency range of 14 kilocycles to 1000 megacycles.

Measurements may be made with peak, quasi-peak and average (field intensity) detector functions.

**F.C.C. PART 15**—Now in effect, the revised F.C.C. Part 15 places stringent requirements upon radiation from incidental and restricted radiation devices. Stoddart equipment is suitable for measuring the radiation from any device capable of generating interference or c-w signal within the frequency range of 14 kc to 1000 mc.

Write Stoddart Aircraft Radio Co., Inc., for your free copy of the new revised F.C.C. Part 15.

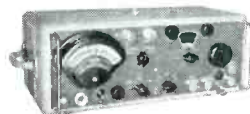

NM-10A (AN/URM-6B)  
14 kcs to 250 kcs

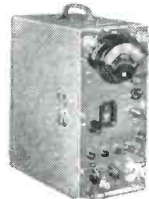

NM-20B (AN/PRM-1A)  
150 kcs to 25 mcs



NM-30A (AN/URM-47)  
20 mcs to 400 mcs



NM-50A (AN/URM-17)  
375 mcs to 1000 mcs

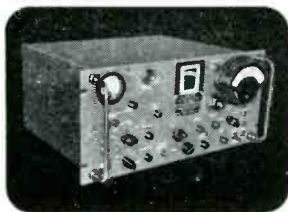

The Stoddart NM-40A is an entirely new radio interference-field intensity measuring equipment. It is the commercial equivalent of the Navy type AN/URM-41 and is tunable over the audio and radio frequency range of 30 CPS to 15 kc. It performs vital functions never before available in a tunable equipment covering this frequency range. Electric and magnetic fields may be measured independently over this range using newly developed pick-up devices. Measurements can be made with a 3 db bandwidth variable from 10 CPS to 60 CPS and with a 15 kc wide broadband characteristic.

## STODDART Aircraft Radio Co., Inc.

6644-A SANTA MONICA BLVD., HOLLYWOOD 38, CALIFORNIA - Hollywood 4-9294

brated in terms of a specific volume flow rate, velocity being directly proportional to volume flow rate through a given size transmitter. The remaining factor, magnetic field density  $h$ , is not easy to measure accurately, especially since the field alternates at 60 cps. No standard commercial devices were available to measure it within  $\pm 1/4$  percent accuracy.

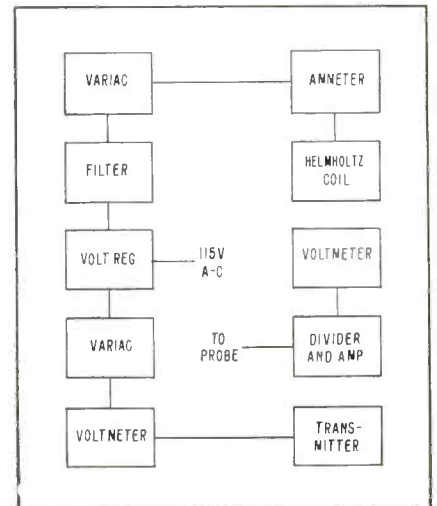

FIG. 3—Block of test equipment for measuring magnetic field

Research into the problem showed the advisability of a comparison method whereby the field density of the transmitter could be compared with a known field density. There are many ways of obtaining a known magnetic field but the most common ones involve the use of an infinite solenoid or a Helmholtz coil. It was decided that the latter would be more convenient to use and would have the additional advantage of providing a known field over a large area within the coils.

The calibration setup consists of a Helmholtz coil shown in Fig. 2, in which two coils are mounted coaxially, the total spacing from the plane of one coil to the plane of the other being equal to the radius of each coil. The several turns on each act as a single-turn coil.

To know the flux density of the field in the center of the Helmholtz coil, it is only necessary to know the physical dimensions of the coils and the current through them. So that these measurements could be



*How optical gaging  
helps get Giannini  
air-borne instrument  
production off the ground faster.*

In the fight for flight that's higher, farther, faster—plane and missile makers want everything smaller, lighter, tighter. Tighter means tolerances today of 0.0002" to 0.0003" compared to 0.003" to 0.004" a few years ago. That's why more and more manufacturers like aircraft and missile instrument and control maker G. M. Giannini & Co., Inc., Pasadena, Calif., are using Kodak Contour Projectors.

A pulley in one Giannini instrument is less than pencil eraser size, has groove dimension tolerance falling between 0.010" and 0.011", four separate angles to check out within 0.30°, a shaft diameter of plus or minus 0.0001" or 0.0002". Perpendicularity must be within 0.0003". Like many aircraft parts, it's made of aluminum alloy.

Before Giannini put a Kodak Contour Projector to work on receiving inspection, getting prototypes of instruments filled with parts like this—and even tighter—used to be a mammoth problem. An undetected off-tolerance part in the master could hold up production or even throw production models out of kilter.

At Giannini, inspectors check incoming parts quickly and accurately with optical gaging, make sure they're

right for the prototype. They optically check angles, shoulders, radii, positions, and all critical surfaces on a single projector. Now there's less chance than ever that production parts will be off tolerance once the master has been approved.

If inspecting small parts to tiny tolerances is a large problem with you, you should investigate optical gaging with a Kodak Contour Projector. A Kodak Contour Projector can work production and quality control miracles where control of measurements makes a better product.

Write for your copy of "Projection Gaging with Kodak Contour Projectors." Even better, ask for the name of your nearest representative, so he can personally explain projection gaging's scope and capabilities.

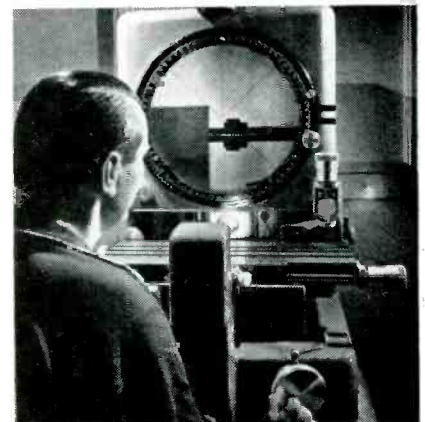

Inspectors quickly learn optical gaging, because it's simply a matter of looking and comparing. Perhaps you can greatly improve Tool-room, Receiving, Production, and Final inspection with a single unit. There are six models to choose from.

**EASTMAN KODAK COMPANY, Rochester 4, N. Y.**

**the KODAK CONTOUR PROJECTOR**

**Kodak**  
TRADE MARK

# Only Precision OFFERS YOU HIGHEST QUALITY, LOW COST PAPER TUBING



in  
any shape  
every size  
any length  
plus  
any ID  
every OD  
any quantity

**DIELECTRIC KRAFT • FISH PAPER • CELLULOSE ACETATE  
COMBINATIONS • PHENOL IMPREGNATED**

Round, square, rectangular, triangular, any shape, any size — Precision Paper Tube Co. can provide *all* your paper tubing needs. Your specifications are met to the most exacting tolerances. Precision Paper Tubes are sturdy, crush resistant, have high tensile strength and excellent dimensional stability.

Send in your specifications for samples. Request Arbor List of over 2000 sizes.



## HIGH DIELECTRIC BOBBINS FOR BETTER COILS

Precision-made on specially designed equipment, using the finest materials, to provide maximum tensile strength, light weight, more winding space and other essential electrical and mechanical characteristics.

Furnished in any size or shape. Supplied plain or fitted with leads, slots or holes. Flanges cut to specification, plain or embossed. Tube ends swaged to lock flanges.

Send Specifications for samples. Ask for illustrated folder.

### Sales Representatives in:

New England: Framingham, Massachusetts, Trinity 3-7091  
Metropolitan New York, New Jersey:  
Jersey City, New Jersey, Journal Square 4-3574  
Upstate New York: Syracuse, New York, Syracuse 4-2141  
Northern Ohio, Western Penn.: Cleveland, Ohio, Atlantic 1-1060  
Indiana, Southern Ohio: Logansport, Indiana, Logansport 2555  
California: Pasadena, California, Sycamore 8-3919  
Canada: Montreal, Quebec, Canada, Walnut 0337



## PRECISION PAPER TUBE CO.

2041 W. CHARLESTON ST.

CHICAGO 47, ILL.

precise, the coil was made large and mounted in an air-conditioned room. Dimensional changes are at a minimum. To guard against effects of any accidental change in ambient temperature, the coil was mounted on an aluminum frame which aids in the radiation of heat and provides further stability.

For convenience, the Helmholtz coil is operated with one ampere of current. Since this current has to be measured with a great deal of accuracy, a calibrated ammeter was provided. Magnifying lenses are used to give maximum readability in setting the one-ampere value of current.

At the dimensions used on the Helmholtz coil and with one ampere of current, the field density is of the order of 4 gauss, which is measured to a precision of  $\pm 0.2$  percent.

A block diagram of the calibrating system is shown in Fig. 3. The 115-volt, 60-cps line is brought into the factory separately to avoid line voltage fluctuations caused by plant machinery. This makes the job of the voltage regulator easier—a desirable feature in that the regulator does not have the speed of response to keep up with fast changes in line voltage. Precise voltages are required only at the

## High Gain Microphone



A reluctance microphone that can be used interchangeably with carbon microphones in two-way communications equipment is possible by use of a built-in transistor preamplifier. The RCA device has an output impedance of 450 ohms and frequency response between 170 and 4,800 cycles



# POLARAD

## TV EQUIPMENT FOR STUDIO and LABORATORY

### WIDE BAND VIDEO AMPLIFIER

10 cps to 20 mc

An oscilloscope deflection amplifier for measuring and analyzing pulses! Extremely wide band with extended low frequency response down to 10 cps. Will accurately analyze television signals. Excellent to increase the amplitude range of your vacuum tube voltmeters and signal generators.



MODEL VT

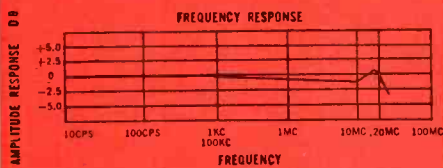

The Polarad Wide Band Video Amplifier offers an extremely wide band coverage: flat within  $\pm 1\frac{1}{2}$  db from 10 cycles to 20 megacycles per second. It has a time delay of 0.02 microseconds and assures extreme stability because of its associated electronically regulated unit. A low capacity input probe is provided.

AVAILABLE ON EQUIPMENT LEASE PLAN

FIELD MAINTENANCE SERVICE AVAILABLE THROUGHOUT THE COUNTRY

### TV STUDIO MONITOR MODEL M-105



MODEL M-105

The Polarad Model M-105 is portable — comes in sturdy aluminum case, can be rack mounted as well! And it is one of the finest instruments available to check the picture quality of video signals. Equipped with 12½" aluminized kinescope, capable of presenting highest definition transmitted pictures with exceptionally good "sync" stability over a wide range of operating conditions.

### PORTABLE TV WAVE FORM MONITOR

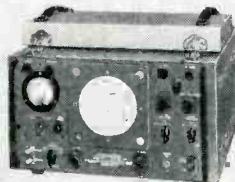

MODEL TO-1

EXCELLENT FOR SUBCARRIER MEASUREMENTS  
LOOK AT THESE FEATURES:

1. Can be rack mounted.
2. Can be used for both color and black and white TV.
3. Vertical Amplifier Bandwidth Switch for 2MC, 4MC, 6MC.
4. Special TV Sync. Circuits.
5. Horizontal Sweep Magnification 20 Tube Diameters.
6. Compact and Rugged.

### VERTICAL MOUNT REGULATED POWER UNITS

Here are electronically regulated power units completely accessible from the front and back because of their vertical mount design. They have extremely fine regulation, low ripple content and appreciable quantities of D. C. power.

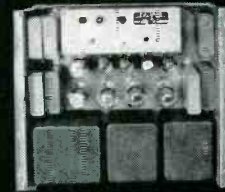

MODEL  
PT-110

	SPECIFICATIONS	
	Model PT-110	Model PT-111
Output Voltage DC	400-450 Volts	250-300 Volts
Output Current	150-235 ma	100-400 ma
Output Impedance	Less than 1.5 ohms	Less than 1.5 ohms
Regulation	Better than 0.2%	Better than 0.2%
Ripple	Less than 12 mv rms	Less than 8 mv rms
Negative Supply	-150 V DC; 20 ma	-150V DC; 10 ma
Filament Supply	a. 6.3V @ 12 a b. 6.3V @ 12 a	a. 6.3V @ 12 a b. 6.3V @ 12 a
Power Input	105-125V 50/400 cps	105-125V 50/400 cps



MODEL  
PT-112

	SPECIFICATIONS	
	Model PT-111D	Model PT-112
	Dual power unit, each side provides:	
Output Voltage	250-300 V DC	250-300 V DC
Output Current	100-400 ma	150-800 ma
Output Impedance	Less than 1.5 ohms	Less than 1.5 ohms
Regulation	Better than 0.2%	Better than 0.2%
Ripple	Less than 8 mv rms	Less than 8 mv rms
Line Voltage	105-125V, 50/400 cps	105-125V 50/400 cps
Series Operation	500-600 Volts	
Output Power	100-400 m	
Parallel Operation	250-300 Volts	
Output Power	200-400 m	

These features assure dependable, highest quality performance:

- Precise electronic voltage regulation
- Low ripple content
- Does not utilize electrolytic condensers
- Sturdy construction
- Provisions for rack mounting.

Polarad manufactures a complete line of color TV equipment including a Color Slide Scanner, Sync Generator, Bar Generator and Color Monitors.



ELECTRONICS CORPORATION 43-20 34th STREET, LONG ISLAND CITY 1, N. Y.

REPRESENTATIVES: Albuquerque, Atlanta, Baltimore, Boston, Buffalo, Chicago, Cleveland, Dayton, Denver, Fort Worth, Kansas City, Los Angeles, New York, Philadelphia, Portland, St. Louis, San Francisco, Schenectady, Syracuse, Washington, D. C., Winston-Salem, Canada; Arnprior, Ontario. Resident Representatives in Principal Foreign Cities

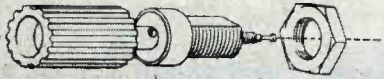

## NEW *Pre-Assembled* NYLON BINDING POST

(PATENT PENDING)

Compact and completely pre-assembled, these rugged "6-way" binding posts are insulated for 8,000 volts breakdown . . . designed for fast, easy mounting. Body is molded of tough, durable, low-loss nylon—shank is silver-plated brass for better contact—easier soldering. (Shank may also be used with solder lug, if desired.) Thumb nut is self-captivated and cannot work loose. Available in 11 bright colors for coded applications. Single  $\frac{5}{16}$ "-32 nut furnished for mounting—no auxiliary mounting hardware required.

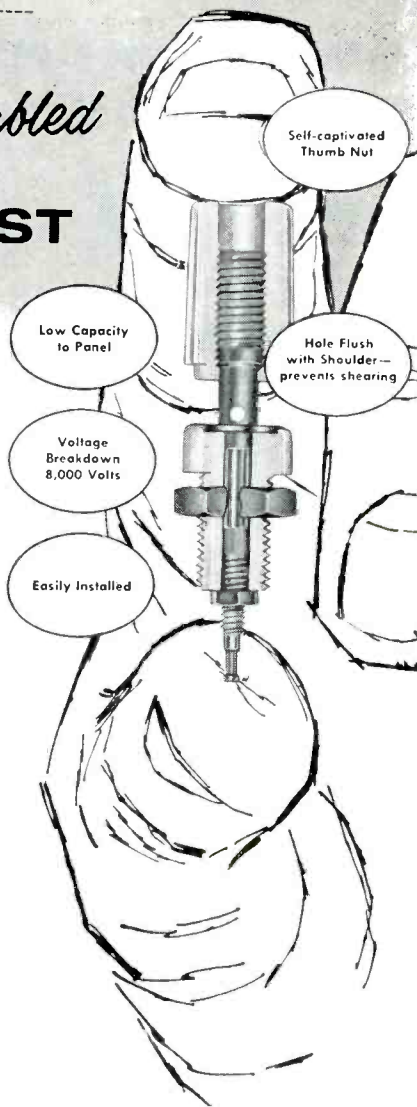
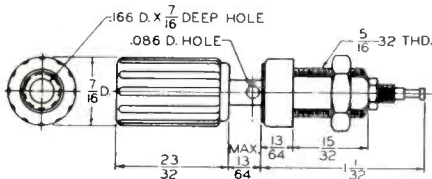

### SPECIFICATIONS

**Insulation Resistance:** Greater than 200 meg. after MIL-T-5422B humidity test.

**Voltage Breakdown:** 8,000 volts.

**Capacity to  $\frac{1}{8}$ " Panel:** 3.3 mmf.

**Current Rating:** 15 amperes.

**Body:** Molded of low-loss nylon.

**Shank:** Silver-plated brass.

**Mounting:** Single  $\frac{5}{16}$ "-32 nut furnished for mounting—no auxiliary mounting hardware required. Mounts in  $2\frac{1}{4}$ " hole, "D" hole or double flat hole.

**Accepts:** .175" Banana Plug, .081" Tip Plug.

### NYLON CONNECTORS

Johnson also manufactures a complete line of nylon insulated connectors. For detailed information, write for your free copy of Components Catalog 977.

**NYLON TIP JACK AND INSULATING SLEEVE**—Complete assembly includes standard nylon tip jack with threaded nylon insulating sleeve. Ideal for patch cords, or panel mounting where an insulated rear connection is desired.

**NYLON INSULATED TIP PLUG**—Recessed metal head is fully insulated. Metal parts are nickel-plated brass—fits all standard tip jacks.

**NYLON INSULATED BANANA PLUG**—Nickel-plated brass with nickel silver springs—fits all standard banana jacks.

**NYLON INSULATED BANANA JACK**—Voltage breakdown: 11,000 volts. Cadmium-plated insert—accommodates standard banana plugs.



**E. F. Johnson Company** *Engineers Wanted*

2310 Second Ave. S.W. • Waseca, Minnesota

For unusual engineering and technical employment opportunities... write to our engineering department.

Capacitors • Inductors • Knobs • Dials • Sockets • Insulators • Plugs • Jacks • Pilot Lights

time of calibration. When installed as a system, the transmitter and receiver will function on line voltages of 115 volts  $\pm 10$  percent with no inaccuracy.

The output of the voltage regulator is fed to a filter designed to remove harmonics from the 60-cycle voltage. The extra filter is needed because the impedance of the Helmholtz coil renders it vulnerable to harmonics. The output of the filter is fed through a variable autotransformer so that the current can be set at exactly one ampere.

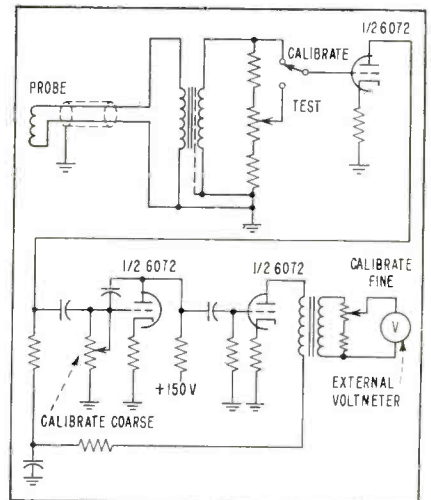

FIG. 4—Probe and amplifier circuit used in field measurements

A separate output from the voltage regulator is fed to another variable autotransformer to furnish exactly 115 volts to the magnetic flow meter transmitter. This voltage does not need filtering because the transmitter acts almost as a pure inductance and is therefore unaffected by harmonics.

To perform the actual comparison between known density and that of the transmitter field, a probe was designed for insertion in the Helmholtz coil and the transmitter pipe. It consists simply of a coil of wire, which is oriented to obtain maximum induced voltage from the known magnetic field. The output of this exploring coil is fed into a precision voltage divider and amplifier, shown in Fig. 4, whose output is indicated on a voltmeter. With the probe inserted and the switch in the calibrate position, the amplifier gain controls are set

# COMPACT 5 IN 1 INSTRUMENTS



OR  
SINGLE UNIT  
MIDGETS

*... Instrument headquarters  
can meet your design requirements, exactly!*

Why compromise on your instrument needs? Whether your design calls for miniature size, or an instrument with several mechanisms within a compact case ... instruments with high torque, high sensitivity, internal shielding, special ballistics, or with pointers of special size or shape ... Weston's wide variety of designs no doubt includes an instrument which will fit your needs exactly. But for new or

unusual needs, engineering cooperation is freely offered to assist you at the drawing board stage. In either case, Weston's long leadership in instrument design is your best assurance of obtaining instruments *tailored to your specific requirements*. Acquaint your local Weston representative with your problem, or write *Weston Electrical Instrument Corporation, 614 Frel-inghuysen Avenue, Newark 5, New Jersey*.

# WESTON

*Instruments*



## What holds this heavyweight battler up...?

Obviously, the North American F-100 Super Sabre flies because it fulfills the aerodynamic laws relating to lift and weight, thrust and drag.

But before an F-100 leaves the ground, its probable conformity to these laws is measured with great care and compared to the data acquired during 50-plus years of aeronautical experience to insure peak performance under the stresses of high altitude, supersonic combat.

Edin Electronic Instrumentation is a key element in flight simulation and pre-flight testing during design and production stages at North American Aviation. In the case of the F-100, custom-adapted 8-channel Edin Recording Oscillographs serve as direct-writing indicators to record aircraft responses as simulated by analog computers.

### ● NEW OSCILLOGRAPH FLEXIBILITY

You, too, can benefit from the amazing flexibility Edin Oscillograph Recorders can provide. For Edin now offers a completely redesigned recording instrument in two models: with modular interchangeable preamps and basic amplifiers; and with standard rack-and-panel single-chassis amplifiers. Modular unit takes up to 8 preamps in the control panel, with amplifier chassis mounted in the lower section of the housing. Records up to 8 channels of transient data simultaneously. User may begin with two channels and add preamps and galvanometers as required.

A wide choice of amplifiers is available including:

Type	Model	Gain*	Response	Noise Level RMS**
High Gain DC	8238	5,000	DC-5K	10uv
Low Gain DC	8231	125	DC-5K	50uv
Condenser Coupled	8234	10,000	1-3K	10uv
High Gain CC	8235	500,000	1-3K	5uv
Modulator	8236	20,000	DC-60	20uv
Pressure	8241	20,000	DC-60	20uv
Stabilized DC	8239	10,000	DC-3K	20uv
Carrier	8237	500,000	DC-500	5uv

\*Preamp and amplifier

\*\*In microvolts referred to input

Write for informative, illustrated literature on oscillograph recording instruments and accessories.



**EDIN COMPANY, INC.**

207 Main St., Worcester, Mass., U.S.A.

so that exactly four volts are indicated on the voltmeter.

The probe is then withdrawn from the Helmholtz coil and inserted in the transmitter pipe. Spacers placed along the axis of the pipe accurately position the probe in the region of the electrodes. With the switch thrown to the test position, the coil is again oriented to give maximum output on the voltmeter and the calibrated dial is manipulated so that, again, four volts appear on the meter. By means of a prepared table, the technician converts the dial reading directly to magnetic-field density in gauss.

Since this part of the calibration involves a relatively short time, long-term stability is not required of the amplifier. Approximately a 100-to-1 voltage division is obtained initially by switching from the calibrate to the test position. This is done because the actual value of field density in the magnetic flow meter transmitter ranges upward to approximately 400 gauss.

The probe tests are repeated a number of times so that an average value of magnetic-field density can be obtained. This value is then used

## Dial Controls Drill

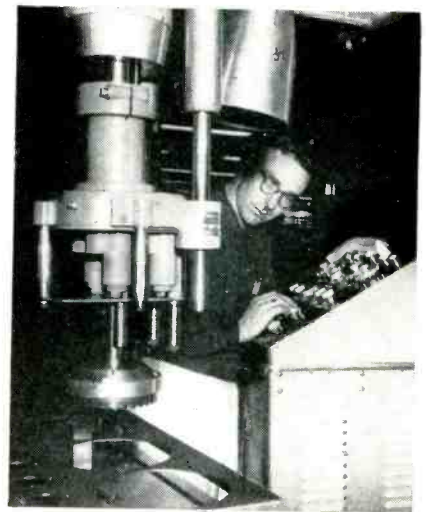

Operator is cutting holes in steel sheet destined to be a master control panel. Dial settings of Minneapolis-Honeywell machine determine the coordinates of hole locations to an accuracy of 0.005 inch. Drill spindle is driven by a variable-speed motor that provides proper rotation for drills as small as 1/32 inch

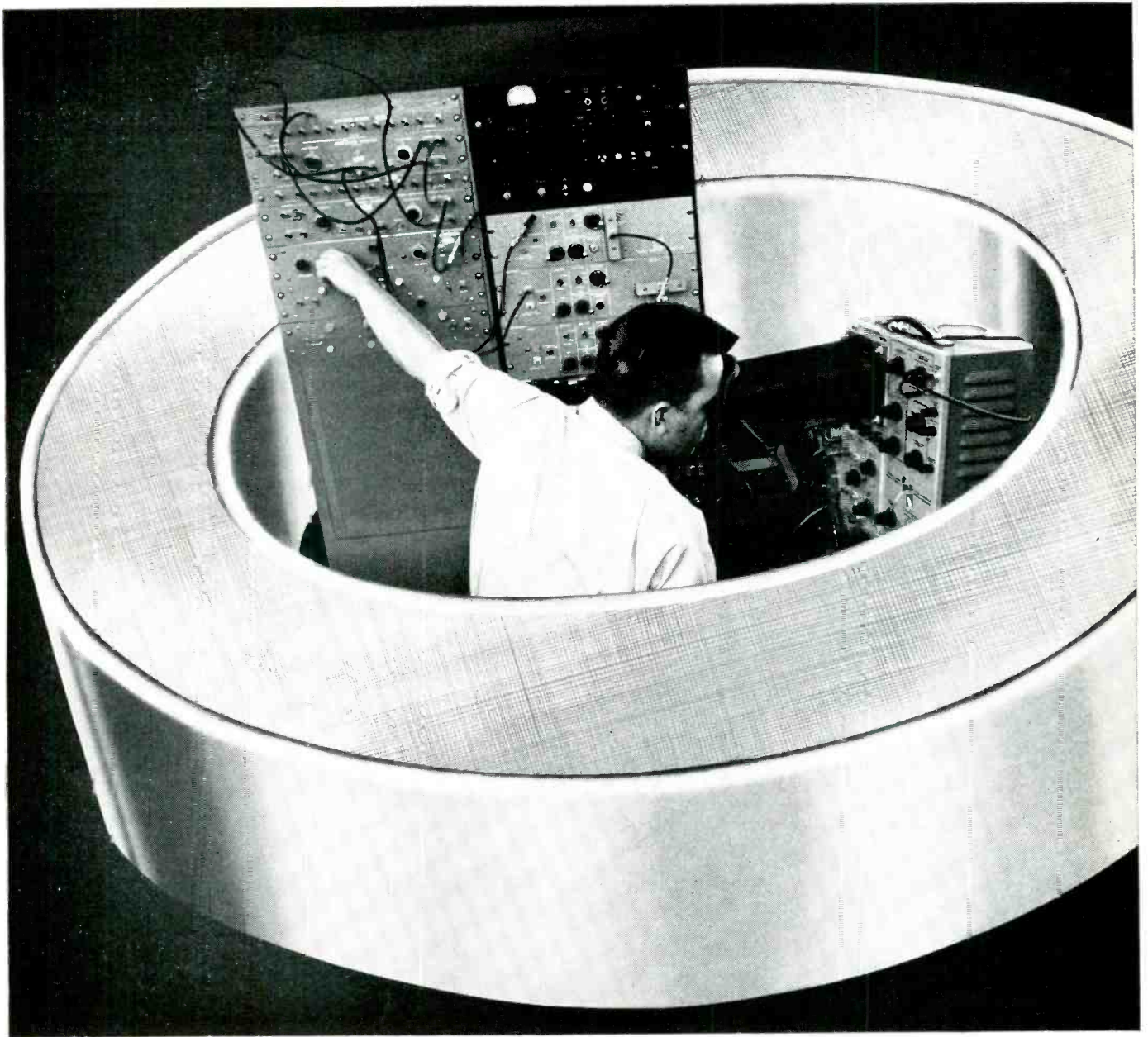

## what makes tape wound cores reliable?

*Reliability demands physical protection.* Magnetic alloys which provide square hysteresis loop characteristics are strain sensitive. Distortion caused by coil winding will disturb precise magnetic characteristics, alter performance. So Magnetics, Inc. has devised a rigid, extra-strong aluminum core box to protect the magnetic core within from winding stresses, thus eliminating distortion.

*Reliability demands electrical stability through the years.* Suppose guided missiles failed to function in a future emergency because the magnetic properties of tape wound cores had changed. Cores must operate just as effectively years from now as they do today, whether or not they have been in use. Vibration, shock, and temperature changes can endanger such performance. That's why Magnetics, Inc. cushions tape windings with a special inert material in the extra-strong aluminum core box. And that's why it is especially important that our tape wound cores enclosed in aluminum boxes will withstand temperatures up to -150°F.

*Reliability demands exacting standards on the part of the manufacturer.* Judge a product by the company that makes it. Take a company that has pioneered a core box so advanced that it even permits vacuum impregnation. Take a company whose attention to design detail permits the offer of the *only* Performance-Guarantee in the industry. That's a real definition of reliability. Why not ask us how it will work for you? *Magnetics, Inc., Dept. E-32, Butler, Pennsylvania.*

For Full Details, Write For  
Catalog TWC-100A

**MAGNETICS inc.**

CABLE: MAGNETICS

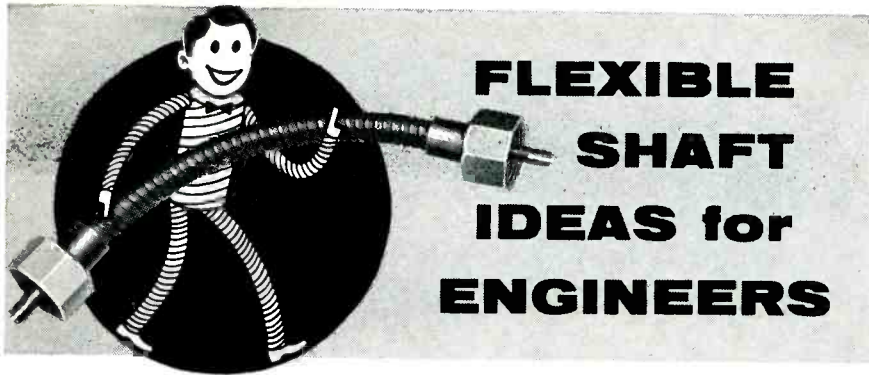

## 4 Ways to profit from a flexible shaft's adaptability

Ideas that may help you design better drives and controls for electronic equipment

S.S.White flexible shafts easily solve these design problems

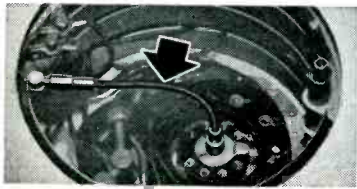

Control of inaccessible parts is easily accomplished by running a single remote control flexible shaft between the controlled element and its control knob.

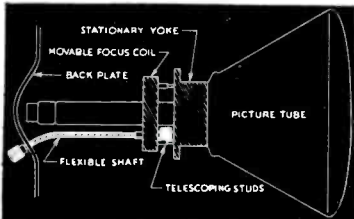

Mounting controls in convenient operating positions is easier when a flexible shaft is used as the coupling. The shaft allows the control to be mounted wherever desired.



Alignment problems are never a factor when you use flexible shafts to couple two parts. Its flexible construction automatically compensates for misalignment.

## FLEXIBLE SHAFT IDEAS for ENGINEERS

### 1. Eliminating Alignment Problems

Where misalignment exists, or where accurate alignment of drive and control elements is likely to be costly and time-consuming, an S.S.White flexible shaft is a "must." The flexible shaft automatically compensates for misalignment, thereby simplifying assembly and eliminating possible operating troubles.

### 2. Providing Adjustable Drives

Where there is relative movement between driving and driven parts, or where the driven part must be moved or adjusted in operation, an S.S.White power drive flexible shaft is an economical, dependable way to transmit power between the two. The shaft readily adapts itself to any operating position and is capable of giving long trouble-free service.

### 3. Gaining Extra Design Freedom

Consider the use of S.S.White flexible shafts if you want to gain greater freedom in positioning drive and control elements in their most desirable locations. It will simplify the job of meeting specific operating and service requirements.

### 4. Satisfying Space Limitations

Flexible shafts are more adaptable, less complicated, less expensive and considerably more compact than systems of bevel gears, straight shafts, belts, pulleys, etc. Their use allows you to develop more efficient, more compact equipment.

### FLEXIBLE SHAFT INFORMATION

Bulletin 5601, a helpful informative guide on flexible shaft construction, selection and application, will be sent on request. Write for your copy.



to calculate the value of the range resistor which will be used in the accompanying recording instrument.

In the primary stages of calibration equipment design, actual flow rate tests were conducted to confirm the validity and accuracy of the calibration method. The basic tests were done by putting through the meter a flow of liquid whose volume rate had been determined by the laboratory standard. This known rate was then compared with the flow rate recorded by the Helmholtz coil instrument.

The same procedure was repeated for metering systems of various sizes, each being tested on a number of different rates of flow. Additional tests were conducted that proved the meter to be unaffected by widely varying liquid conductivities and turbulent flow conditions.

## Receiver Calibrates TV Modulation Monitors

By ROBERT D. LAMBERT, JR.  
Engineering Consultant  
Columbia, S. C.

THE method of f-m modulation monitor calibration based on the fact that with single frequency sinusoidal modulation certain values of modulation index give zero carrier amplitude is widely used.

This principle can be applied using a receiver which covers the appropriate frequency range and has sufficient selectivity to separate the carrier from the sideband frequencies. However, receivers meeting these requirements are not commonly found, particularly if it is desired to check the modulation of the aural transmitter of a uhf tv station.

It is possible to apply this method by tuning the receiver to the exciter output or the output of one of the frequency multipliers usually found in such transmitters. However, the frequency deviation at such points is proportionately reduced and inconveniently low modulation frequencies may be re-

S.S.White

FIRST NAME

IN FLEXIBLE SHAFTS

S. S. WHITE INDUSTRIAL DIVISION, DEPT. E, 10 EAST 40th ST., NEW YORK 16, N. Y.

Western Office: 1839 West Pico Blvd., Los Angeles 6, Calif.

F6-6A

# New Design

## CLAROSTAT VARI/PHASE<sup>T.M.</sup>

### ELIMINATES CLAMPING RINGS



variable-phase  
single-turn  
precision  
potentiometer

Simplified phasing — external independent phasing of each cup does not affect relationship of others. To phase, simply loosen clamping nut, move terminal board in desired direction, tighten clamping nut — and that's it! Micrometer tension adjustment assures equal torque and tracking at all times. Meets specifications set forth by A.I.A. (Aircraft Industries Associated). Others available. Five sizes:  $\frac{7}{8}$ "",  $1\frac{1}{4}$ "",  $1\frac{5}{8}$ "", 2" and 3" dia. Write for complete electrical and mechanical details.

ENVISIONED, ENGINEERED AND PERFECTED BY...



**CLAROSTAT MFG. CO., INC.**

Dover, New Hampshire

In Canada: CANADIAN MARCONI CO., LTD.,

Toronto 4, Ont.

*translate flow*  
*... into pounds per hour*  
**at a glance!**

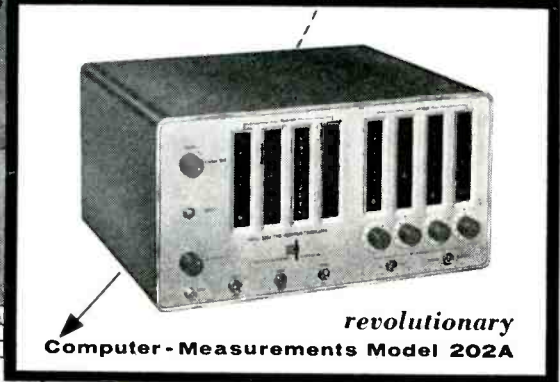
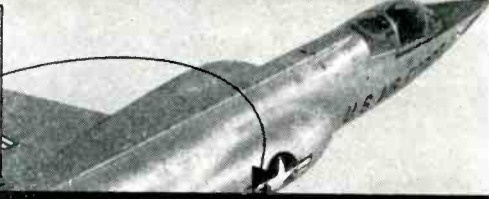

*revolutionary*  
**Computer - Measurements Model 202A**

## TIME-FUNCTION TRANSLATOR

### Applications:

- ✓ Gallons per minute . . . into Gallons per hour
- ✓ Gallons per minute . . . into Pounds per hour
- ✓ Pulses per second . . . into Gallons per minute
- ✓ Total Count of Gallons or Pounds
- ✓ Tachometer Applications
- ✓ Direct Frequency Measurement
- ✓ Many Others

Translating flow into weight as required for jet engine analysis is just *one* of the *many* uses for the *all-new* Model 202A TIME-FUNCTION TRANSLATOR. The 202A permits *instant* direct read-out of unknown quantities by translating one function of time into another function of time. It eliminates the need for conversion tables, graphs, charts, etc. The variable time base display may be illuminated or blanked at operator option. The versatile 202A fills a long recognized need in electronic measurement.

*Write for complete information and detailed specifications on the Model 202A Time-Function Translator TODAY...*

### SPECIFICATIONS:

Frequency Range:	1-100,000 cycles per second 0-100,000 positive pulses per second
Input Sensitivity:	0.05 volt rms: 10-100,000 cps (5 millivolts optional) 0.07 volt rms: 1-10 cps Positive pulse rise time: 1/2 volt or more per sec.
Input Impedance:	0.5 megohm and 50 mmf.
Accuracy:	± 1 count ± stability
Stability:	Short Term: 1 part in 1,000,000 Long Term: 5 parts per million per week
Time Bases:	0.001 to 10 seconds in 1 millisecond steps 0.0001 to 1 second in 0.1 millisecond steps (0.0001 to 10 sec. in 0.1 millisecc. steps, 0.001 to 100 sec. in 1 millisecc. steps optional)
Read-Out:	Direct. Four digits. (Five digits optional)
Display Time:	Automatic: Continuously variable, 0.1 to 10 sec. Manual: Until reset
Power Requirements:	117 volts ± 10%, 50-60 cycles, 250 watts (50-400 cycles optional)
Dimensions:	17" W x 8 3/4" H x 13 1/2" D
Weight:	35 lbs. net.
Finish:	Panel: Light grey baked enamel Case: Dark grey baked enamel
	<i>Data Subject to Change Without Notice</i>

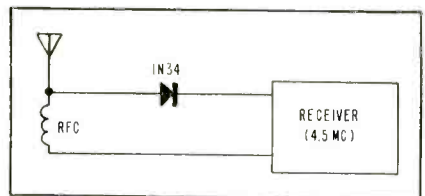

FIG. 1—Simple circuit for calibrating tv aural percentage modulation monitors. The r-f choke should have a high impedance at carrier frequencies involved

quired for the first carrier null (modulation index = 2.40).

As an example suppose the aural carrier frequency is 540 mc and the aural exciter output one-eighteenth of this. Thus 100 percent modulation (25 kc deviation) is obtained with only 25/18 or about 1.39 kc deviation at the exciter output. Hence, the first carrier null requires a modulating signal of 1.39/2.40 or about 580 cps. This may result in difficulty in detecting the carrier null owing to the small spacing between the carrier and sideband frequencies.

This is overcome by using the circuit shown in Fig. 1. A small amount of signal from both visual and aural transmitters is fed to the diode. The resulting 4.5-mc difference frequency is detected by a communication receiver.

The full frequency deviation of the aural output will be transferred to the 4.5-mc difference frequency and carrier nulls corresponding to the several values of modulation index can be detected owing to the convenient modulating frequencies that can be used. An incidental advantage is that the 4.5-mc carrier separation between aural and visual transmitters can be readily and accurately checked

## Airborne Video



Video coder developed by Philco for the Air Force feeds information into transmitter (left)



\*Model FL Flow Pickup: Courtesy—Wagh Engineering Co., Van Nuys, Calif.

**Computer-Measurements Corporation**

5528 Vineland Avenue, North Hollywood, Calif. Dept. 78-K



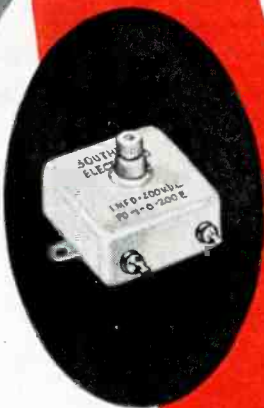
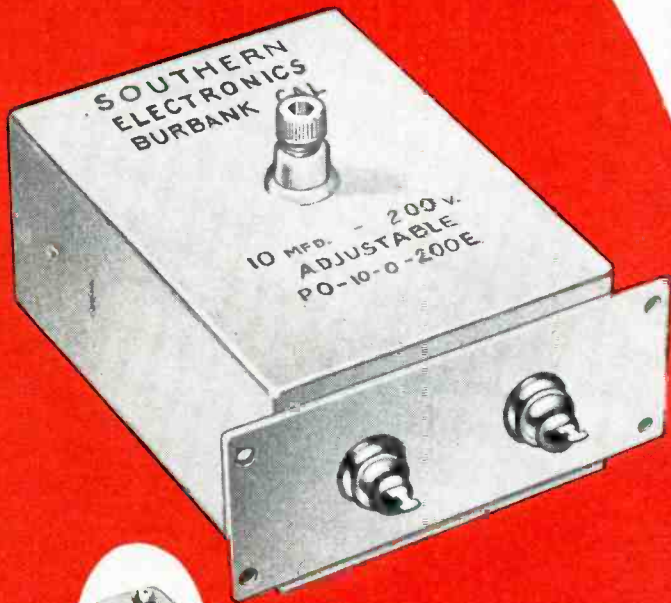

**NOW AVAILABLE FROM  
0.1 M.F.D. to 10 M.F.D.**

Check these outstanding features:

- Accuracy in the order of 0.1% or better!
- Long Time stability in the order of 0.03%!
- I.R. — @ 25° C —  $10^{12}$  OHMS
- Dielectric Absorption — .015%
- Dissipation Factor — .0002
- Temp. Coeff. (—20° to 140° F.) 100 P.P.M. per °C

Excellent for Computer Integration, Test Equipment or Secondary Standards.

America's electronic leaders specify Southern Electronics' polystyrene capacitors for their most exacting requirements. Goodyear Aircraft, Beckman Instruments, Reeves Instrument Corp., Electronic Associates, Inc., Convair, M.I.T., Calif. Inst. of Tech., and many others. Make sure you're getting the finest — always specify S.E.C.!

Wire, write or phone for complete catalog today!

**ADJUSTABLE**  
precision  
polystyrene  
capacitors

... WITH PERFECT  
HERMETIC SEAL TO  
INSURE EXTREMELY  
LOW LEAKAGE!



**SOUTHERN ELECTRONICS**  
*Corporation*

239 West Orange Grove Ave., Burbank, California

# Here's how Pacific Automation Products makes special Electronic Cable easy to procure...

## CABLE PROCUREMENT INFORMATION

By completing the following form you will give us sufficient information for designing a cable for which we will gladly submit price, delivery, and technical data (size, weight, bend radius, etc.).

CABLE NAME OR NUMBER \_\_\_\_\_

TOTAL FOOTAGE \_\_\_\_\_

MINIMUM ALLOWABLE LENGTHS \_\_\_\_\_

UPPER OPERATING TEMPERATURE LIMIT \_\_\_\_\_

LOWER OPERATING TEMPERATURE LIMIT \_\_\_\_\_

APPLICATION (Underwater, buried, severe abrasion, flame, etc.) \_\_\_\_\_

MAXIMUM OPERATING VOLTAGE \_\_\_\_\_ TEST VOLTAGE \_\_\_\_\_

### CABLE CIRCUITRY

Wire Size

Type Wire

No. of Conductors

### CONNECTORS

POTTING

SPECIAL HARDWARE

BREAKOUTS (Describe)

ADDITIONAL INFORMATION (color coding, numbering, shielding, etc.) \_\_\_\_\_

YOUR NAME AND TITLE \_\_\_\_\_

COMPANY \_\_\_\_\_

STREET ADDRESS \_\_\_\_\_

CITY AND ZONE \_\_\_\_\_

Fill out this form — clip the advertisement — and mail it to us and we will supply the information indicated. No obligation, of course.



**Pacific Automation Products, Inc.**

1000 AIR WAY, GLENDALE 1, CALIF.

CHapman 5-6871 • TWX GLN-7371

Engineers and technicians will find a challenging and fascinating career with us. Your qualifications are welcomed.

Write for Bulletin 158 — "Electronic Cable as a Systems Component"

using a conventional heterodyne frequency meter.

If the equipment is set up near the transmitter, a short piece of wire used as an antenna will usually give adequate pickup from both transmitters. Null detection can be made somewhat easier if all modulation of the visual transmitter is temporarily removed; however, this is not necessary.

It is necessary that the input circuit of the receiver be continuous to d-c otherwise a suitable 4.5-mc r-f choke may be placed across the receiver terminals. The r-f choke on the antenna side of the diode is not critical, however it would be advisable to use one having reasonably high impedance at the carrier frequencies involved.

Modulation monitor calibration may be checked using Table I. This table is worked out for three different modulation percentages based on a 2,890 cps a-f. This frequency results in sideband spacing that allows easy carrier null detection on a communications receiver.

Table I—Calibration of Modulation Percentages

Car Null	Mod Index	Freq Dev	Percent Mod
1	2.40	6.94 kcs	27.7
2	5.52	15.93	63.8
3	8.65	25.00	100.0

Modulation frequency = 2890 cps

## Controlled Diode Breakdown



Diffused junction silicon diodes can be made with predictable sharp impedance variation as indicated by the oscilloscope trace. Junction impurity gradient controls breakdown voltage over a range from 5 to 500 volts. Bell Labs unit shown breaks down at 20 volts and can dissipate 6 watts



# Could you contribute new ideas to these new fields?

- Nuclear Weapons*
- Nuclear Rocket Propulsion*
- Controlled thermo-nuclear energy*
- Particle accelerators*
- High-speed digital computers*
- Critical assembly and reactor research*

These are six of the challenging projects now underway at the University of California Radiation Laboratory—managed and directed by some of America's foremost scientists and engineers.

You are invited to join them... share their pioneering knowledge in nuclear research... use their expansive facilities... and help to do what has never been done before.

**I**F YOU are a **MECHANICAL** or **ELECTRONICS ENGINEER**, you may be involved in a project in any one of these fields, as a basic member of the task force assigned each research problem. Your major contribution will be to design and test the necessary equipment, which calls for skill at improvising and the requisite imaginativeness to solve a broad scope of consistently unfamiliar and novel problems.

If you are a **PHYSICIST** or **MATHEMATICIAN** you may be involved in such fields of theoretical and experimental physics as weapons design, nuclear rockets, nuclear emulsions, scientific photography (including work in the new field of shock hydro-dynamics), reaction history, nuclear physics, critical assembly, high current linear accelerator research, and the controlled release of thermo-nuclear energy.

If you are a **CHEMIST** or **CHEMICAL**

**ENGINEER**, you will work on investigations in radiochemistry, physical and inorganic chemistry and analytical chemistry. The chemical engineer is particularly concerned with the problems of nuclear rocket propulsion, weapons and reactors.

In addition, you will be encouraged

to explore fundamental problems of your own choosing and to publish your findings in the open literature.

And for your family—there's pleasant living to be had in Northern California's sunny, smog-free Livermore Valley, near excellent shopping centers, schools and the many cultural attractions of the San Francisco Bay Area.

### *You can help develop tomorrow—today at UCRL*

Send for complete information on the facilities, work, personnel plans and benefits and the good living your family can enjoy.



DIRECTOR OF PROFESSIONAL PERSONNEL  
UNIVERSITY OF CALIFORNIA RADIATION LABORATORY  
LIVERMORE, CALIFORNIA

Please send me complete information describing UCRL facilities, projects and opportunities.

My fields of interest are \_\_\_\_\_

Name \_\_\_\_\_

Address \_\_\_\_\_

City \_\_\_\_\_ Zone \_\_\_\_\_ State \_\_\_\_\_

63-1-1

## THE COVER: Transistor Amplifier Packaged in Steatite



Setup for screen-printing silver conductors and carbon resistors on steatite blocks that serve as amplifier chassis



Air-operated soldering iron hermetically seals transistors in cavities of blocks under accurately controlled atmosphere of dry air

CERAMIC SLABS smaller than a U. S. commemorative postage stamp serve as the chassis for a four-transistor amplifier now in production at Centralab's Milwaukee plant.

A unique new Centralab germanium transistor encased in a molded plastic wafer by mass-production methods is the heart of this amplifier. Improved ceramic materials combined with new production techniques for applying silver conductors and printed resistors are factors contributing to the practicality of this subminiature design. An epoxy resin coating gives electrical and mechanical protection to the finished amplifiers.

► **Wiring**—Conductive silver wiring is applied to fired steatite blocks by silk screening, using a combination of air cylinders to perform the required operations after the operator drops the block into the hold-

ing jig. A foot pedal initiates the screening cycle, which involves moving the slab under the silk screen, bringing it up to the screen in the correct position, moving the squeegee across the top of the screen to apply the silver, then bringing the slab back out for unloading. The entire operation takes just a few seconds, permitting a high production rate.

After the silver-bearing ink has dried enough to prevent smearing, the slabs are put through the process again to apply wiring to the opposite side. After this has dried, the silver is fired to convert the wiring pattern to approximately 99 percent pure silver.

Printed resistors are applied over the silver wiring in similar silk-screening setups, making one pass for each resistance value required. After all resistors have been applied, another firing removes the volatile solvents from the inks.

► **Assembly**—After external leads have been soldered to the silver wiring, four transistors are dropped into molded recesses of each block. A solder ring and metal cover plate are then dropped over each transistor, after which the transistor cavities are hermetically sealed with an air-operated soldering bit in an atmosphere of dry air. This is done in a soldering fixture that automatically steps the row of steatite blocks to the next position.

► **Capacitors**—Ceramic capacitor disks are soldered into position over the four transistor cover plates. These disks are screened with a silver pattern in quantities of 64 at a time in a production setup that combines a vacuum frame with automatic air-operated positioners so that only the squeegee is manually moved.

Loading of the vacuum frames is achieved in much the same man-

# *Tunes* UP TIRED ASSEMBLY LINES



"44" RESIN, "RESIN-FIVE" and PLASTIC ROSIN—  
Kester Flux Core Solders belong at the very top  
of the solder hit parade when it comes to quality,  
speed, uniformity and economy. An unbroken rec-  
ord of dependability is what makes Kester a sure-  
fire "cure" for lagging production. Better switch  
now to Kester . . . a real production record maker!

WRITE TODAY for Kester's New 78-  
Page Informative Textbook, "SOLDER...  
Its Fundamentals and Usage."

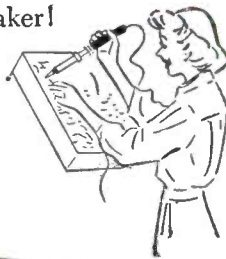

# KESTER SOLDER

COMPANY 4204 Wrightwood Avenue, Chicago 39, Illinois; Newark 5, N. J.; Brantford, Canada,

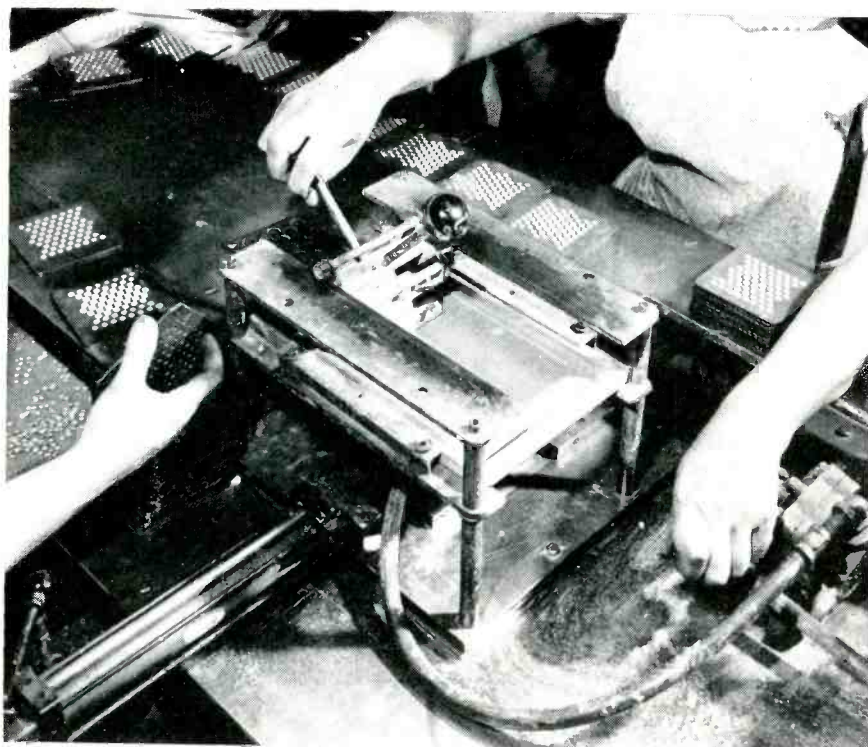

Unfired ceramic capacitor disks on vacuum frames are screened with silver pattern 64 at a time on air-operated production fixture



Final test station for finished transistor amplifiers. Operator pushes seven leads down between plastic wedges into contact blades to make all connections simultaneously for gain, frequency response and noise tests



Applying epoxy resin coating to finished amplifiers with wood paddle, using 24-unit turnover holding fixture

ner that ferrite doughnuts for computer memory planes are loaded into position for wiring. This involves placing a 64-hole guide plate over the vacuum frame, dumping a handful of ceramic disks over this, then shaking or vibrating them into position. With vacuum holding the disks in position, the guide plate is removed and the vacuum frame is transferred to the vacuum-equipped bed of the silk-screening mechanism. A flip of an air valve lever then brings the disks into position under the silk screen. Closing of the air valve gives retraction without smearing after the operator has moved the squeegee across.

Screened disks are then transferred from the vacuum frames to large ceramic slabs for oven firing.

► **Testing**—After silvered capacitor disks have been soldered into position to complete the amplifier assembly, the units go to a final performance test station. Here a row of plastic wedges serves to guide the seven bare wire leads of the amplifier down to the spring contact terminals of the test set.

► **Encapsulating**—Final step in the production of the transistor amplifier involves mounting 24 units at a time in a holding frame that grips the leads while leaving the units suspended in air. An operator then uses a small wood paddle to transfer freshly mixed epoxy resin from a paper cup to each in turn. The stick serves efficiently for pushing the resin around.

After all 24 units have been coated on one side and allowed to harden, the holding fixture is turned over and more epoxy is applied to the other sides to complete the production operation.

## Precision Screw Drives Germanium Crystal Grower

SMOOTH RETRACTION of single-crystal germanium ingots during growing is achieved in Philco's Lansdale, Pa. plant through use of a motor-driven pulling mechanism. Two motor drives are used, with magnetic clutching, to provide either rapid advance or slow, smooth pulling at adjustable speeds.

An induction heater energizes a work coil surrounding the crucible that contains the molten germanium, to keep it in a molten state.

► **Temperature Control** — In the control system a sapphire rod (a single pure crystal of aluminum oxide  $\frac{1}{8}$  inch in diameter and gen-

erally about 12 inches long) acts as a transmission line for the infrared rays from the quartz-lined carbon crucible. The rod is focused on the bottom of the crucible holding the molten germanium or silicon and transmits radiant energy back through the rod to a thermopile. This acts through a special

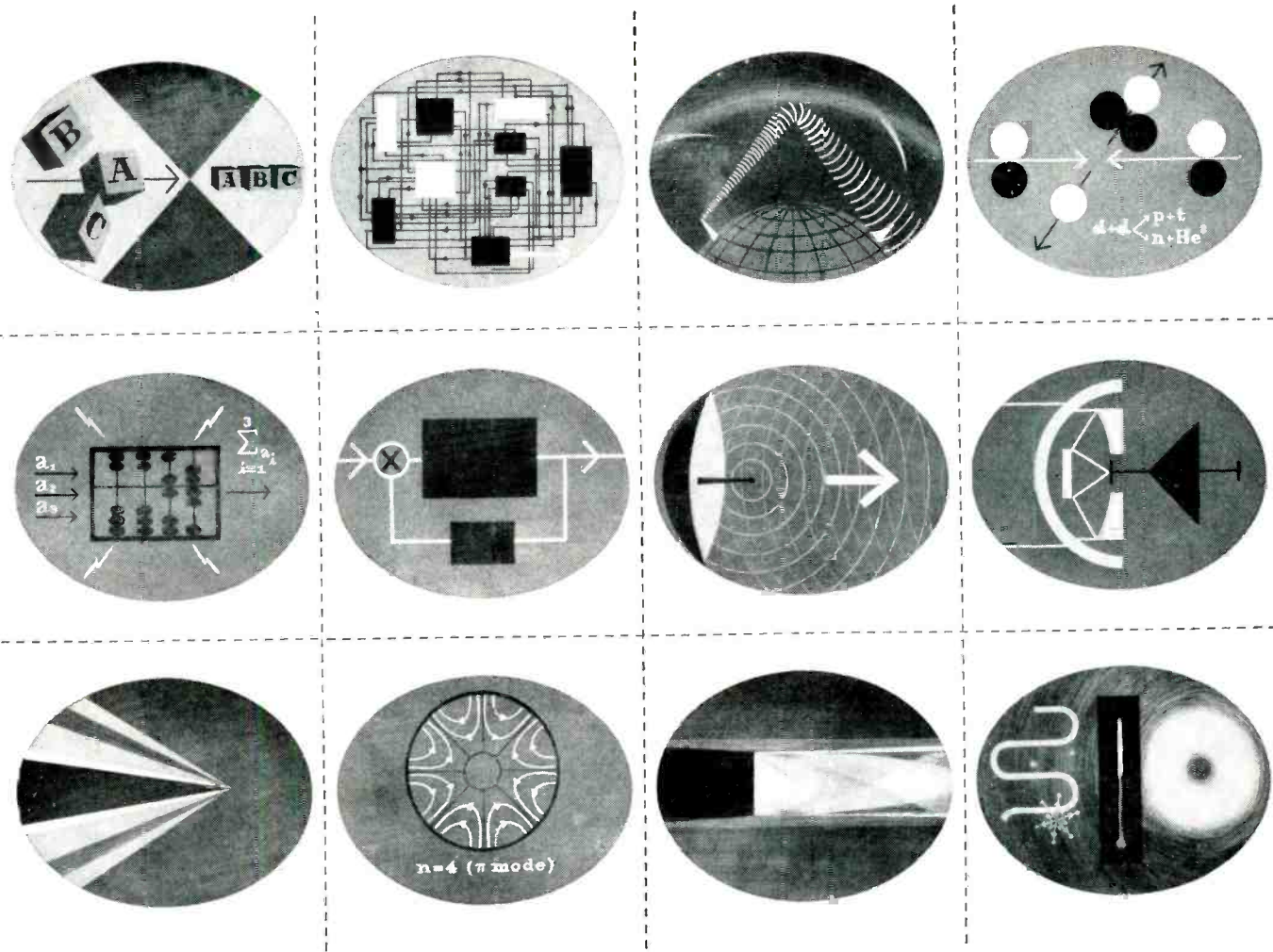

## Variety of Technical Fields

These illustrations are symbolic of some of the scientific and engineering fields of endeavor which are essential ingredients in the broad range of technical programs that are in progress at The Ramo-Wooldridge Corporation. Illustrated are: Information Theory, Systems Analysis, Communications, Nuclear Physics, Electronic Computers, Servomechanisms, Electromagnetic Propagation, Infrared, Aerodynamics, Microwaves, Propulsion, and Thermodynamics.

The requirement for technical competence in a wide variety of fields is a significant characteristic of systems engineering work. At R-W this requirement is particularly important because of our emphasis on the development of systems having a high content of scientific and engineering newness.

Our current military contracts support a number of advanced programs in the fields of modern communications, digital computing and data processing, fire control and navigation systems, instrumentation and test equipment. In the guided missile field, Ramo-Wooldridge has technical direction and systems engineering responsibility for the Air Force Intercontinental and Intermediate Range Ballistic Missiles. Our commercial contracts are in the fields of operations research, automation, and data processing. All of this work is strengthened by a supporting program of basic electronic and aeronautical research.

*Scientists and engineers whose training and experience are in these or related fields are invited to explore the openings at The Ramo-Wooldridge Corporation.*

## The Ramo-Wooldridge Corporation

5730 ARBOR VITAE STREET · LOS ANGELES 45, CALIFORNIA





Minneapolis-Honeywell or Leeds & Northrup electronic temperature control system to adjust crucible temperature by regulating the power feed to the induction generator.

The radiation control system eliminates the measuring lag characteristic of thermocouple systems. It also provides an average measurement of the molten silicon temperature as contrasted to measurement of a single point. The sapphire rod is especially suited for accurate measurements at temperatures around 1,500 C, and has an appreciably longer life than the thermocouple-type sensing units.

**Furnace setup for growing single crystals of germanium and silicon. Heat is furnished by r-f coils surrounding crucible**

## Stick Holder for Multiple Coil Winder

A SIMPLE MODIFICATION of a standard bench-type multiple coil winder helps operators in the transformer department of Lenkurt Electric Co., San Carlos, Calif., to change sticks of coils.

Two metal hooks bolted to the framework of the machine below the carriage assembly are the only parts added. The hooks are placed vertically, with the points forward and the open sides down, since uncut coil wires pull the mandrel up.

► **Method of Use**—When the mandrel containing the completed stick of coils is removed from the driving head and tail stock, it is placed in the inverted hooks. A pin on the left end of the mandrel fits into a hole in the tip of the left-hand hook, preventing the mandrel from turning. Tension of the wires coming down from the overhead dereelers through the wire guides holds the mandrel in place while the operator clamps the new mandrel and stick

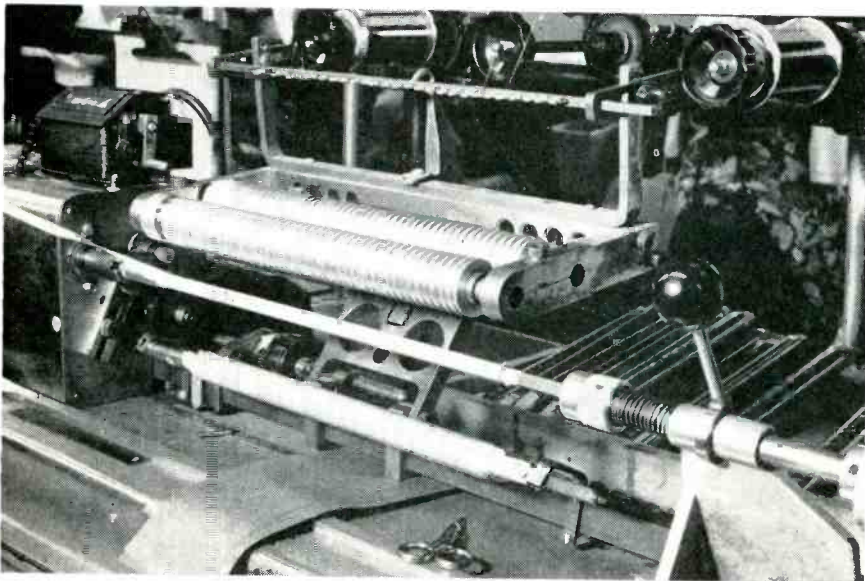

Completed stick, still on mandrel, is held by inverted hooks while operator loads and prepares new mandrel for transfer of wires

## To the ENGINEER of high ability

Through the efforts of engineers The Garrett Corporation has become a leader in many outstanding aircraft component and system fields.

Among them are:

- air-conditioning
- pressurization
- heat transfer
- pneumatic valves and controls
- electronic computers and controls
- turbomachinery

The Garrett Corporation is also applying this engineering skill to the vitally important missile system fields, and has made important advances in prime engine development and in design of turbochargers and other industrial products.

Our engineers work on the very frontiers of present day scientific knowledge. We need your creative talents and offer you the opportunity to progress by making full use of your scientific ability. Positions are now open for aerodynamicists . . . mechanical engineers . . . mathematicians . . . specialists in engineering mechanics . . . electrical engineers . . . electronics engineers.

For further information regarding opportunities in the Los Angeles, Phoenix and New York areas, write today, including a resume of your education and experience. Address Mr. G. D. Bradley

### THE GARRETT CORPORATION

9851 So. Sepulveda Blvd.  
Los Angeles 45, Calif.

**DIVISIONS**

AiResearch Manufacturing,  
Los Angeles

AiResearch Manufacturing,  
Phoenix

AiResearch Industrial  
Rex — Aero Engineering  
Airsupply — Air Cruisers  
AiResearch Aviation  
Service



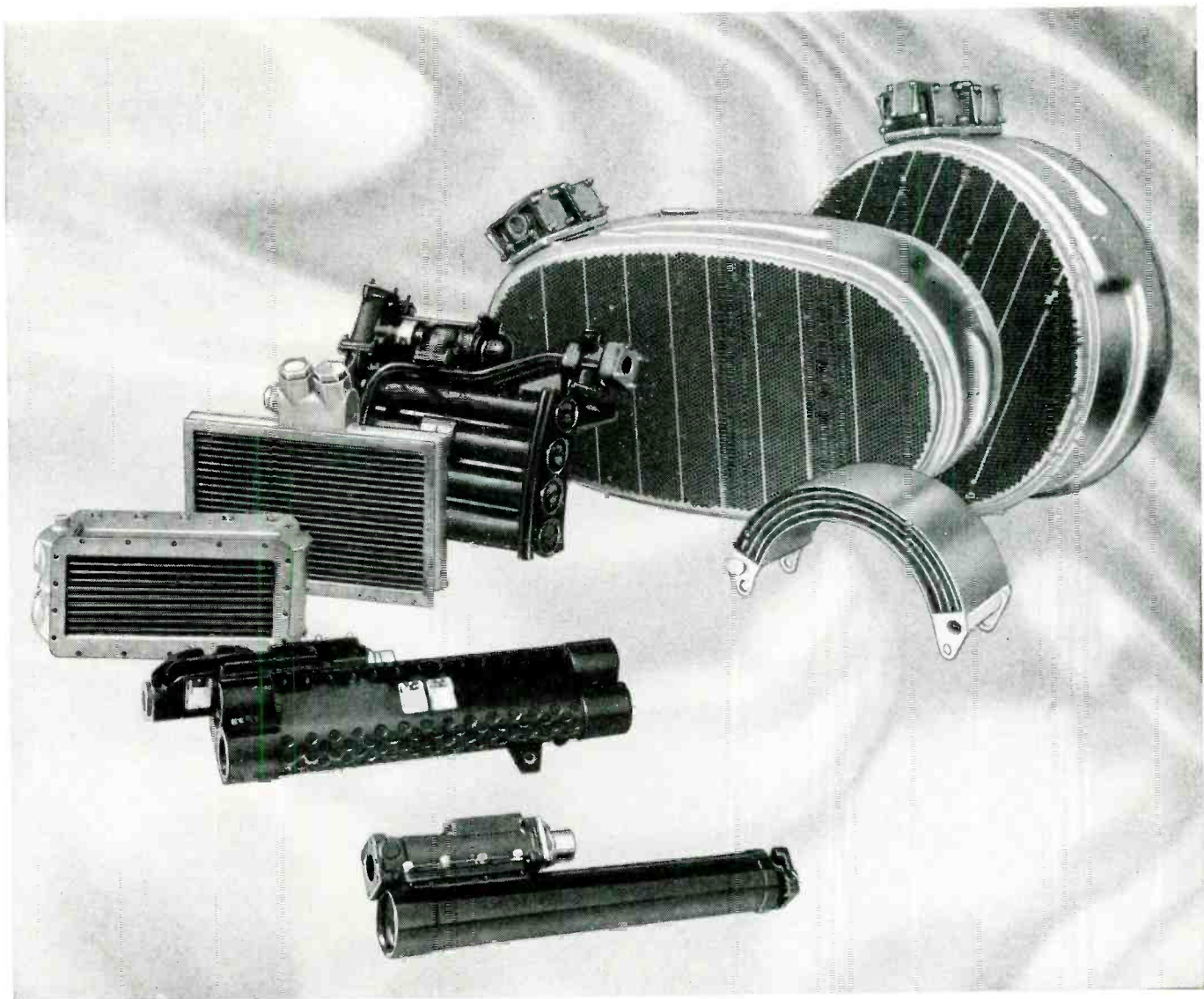

## FOR EVERY AIRCRAFT APPLICATION

# AiResearch oil temperature regulators

*Exclusive design featuring mechanically-bonded, replaceable tubes allows for easy repair in the field*

AiResearch is the largest manufacturer of aircraft oil temperature regulators in America. High efficiency, easy repair, long life and normal operation under extreme

sub-zero temperatures has established industry-wide preference for AiResearch units. They are manufactured to rigid specifications, and their appearance and reliability reflect the most careful craftsmanship.

AiResearch has been building oil temperature regulators of the highest quality since 1940. Many have had more than 20,000 hours of

operating service and are still performing with complete efficiency.

Let us discuss your oil cooling problems with you. After analysis, our engineers will suggest a solution which will stand up on the basis of both present need and future dependability.

*Qualified engineers are needed now. Write for information.*

**THE GARRETT CORPORATION**  
**AiResearch Manufacturing Divisions**

Los Angeles 43, California . . . Phoenix, Arizona

Designers and manufacturers of aircraft systems and components: REFRIGERATION SYSTEMS • PNEUMATIC VALVES AND CONTROLS • TEMPERATURE CONTROLS  
 CABIN AIR COMPRESSORS • TURBINE MOTORS • GAS TURBINE ENGINES • CABIN PRESSURE CONTROLS • HEAT TRANSFER EQUIPMENT • ELECTRO-MECHANICAL EQUIPMENT • ELECTRONIC COMPUTERS AND CONTROLS

# DURANT

MFG. CO.

## Specials

For RADAR, ELECTRONIC  
and INSTRUMENT APPLICATIONS

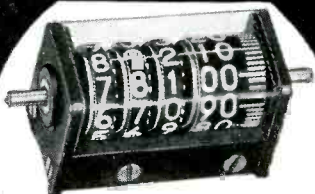

High speed, non-reset, direct reading counter to indicate increment of measurement in radar navigation instruments.



High-speed dual bank counter for use in navigating instruments. Shutter operates to close off either bank when in the minus side.

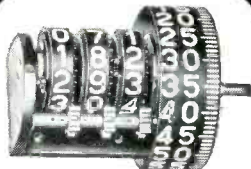

Counter assembly component of navigating instrument to indicate increments of measurement for fast, legible, direct "read-out".

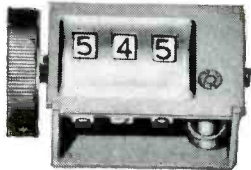

Special counter for use on Tape Recorder to indicate the position of tape passing through the recorder.

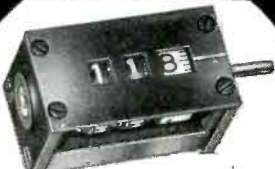

Direct reading counter for navigating and directional instruments. Unit wheel graduations permit reading of 150,000 increments per minute.

Representatives in Principal Cities

WRITE FOR LITERATURE

**DURANT MANUFACTURING CO.**

1912 N. Buffum St. Milwaukee 1, Wis.  
12 Thurbers Ave. Providence 5, R. I.

**PRODUCTIMETERS**  
SINCE 1879 *Count Everything*

Want more information? Use post card on last page.

PRODUCTION TECHNIQUES

(continued)

in the winding machine (model AM, made by Coil Winding Equipment Co., Oyster Bay, N. Y.).

When the new stick is in place, the operator removes the old mandrel and stick from beneath the hooks, brings it forward and up around the new stick and rests it

on top of the wire guides. Preserving tension in the wires, the operator runs a strip of tape along the new stick securing the wires. A single motion along the edge of the new stick with scissors, a knife or a fingernail severs all the wires from the finished coils.

## Metal Guard Improves Toroid Winder

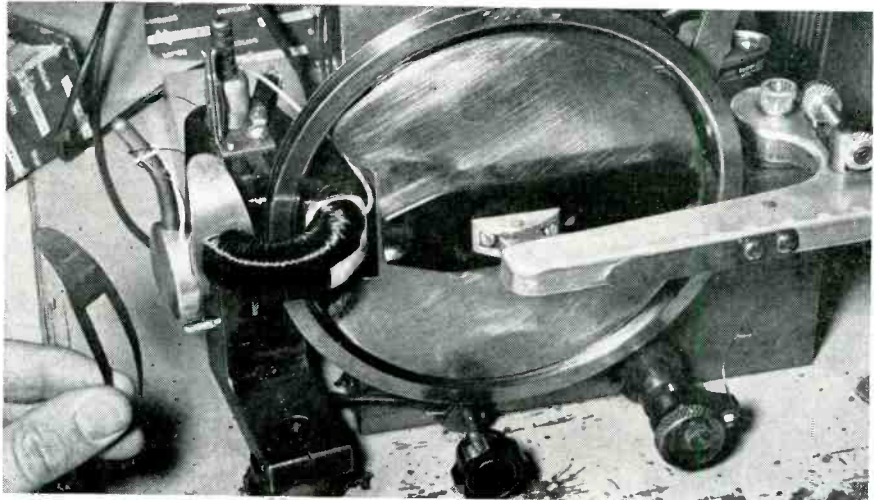

Guard in position on toroid to prevent turns from jumping over spacer onto wrong half of core. Operator is holding extra guard at lower left to show construction

WINDING OF TOROIDAL COILS at the San Carlos, Calif., plant of Lenkurt Electric Co. is facilitated by the use of slender metal guards to confine wire to the desired portions of the coils, as required for use in carrier and microwave equipment. A phase-shift winding technique, used for measuring the inductance of coils as they are wound, permits production runs that are within 1 percent tolerance.

The toroid being wound is half-covered by the jaws clamping it in place in the machine, while a shuttle ring feeds wire. At the end of

a wind, occasional trouble was experienced when the wire would jump over the small spacer. This meant that the operator would have to stop and peel off these few turns.

An oval-shaped guard of 0.018-inch phosphor bronze, slipped over the toroid in front of the spacer, provided the answer. Previously, 80 to 100 coils a month were rejected for wire over the spacer. These rejections have been eliminated in all cases where the guard was applied, even though the production of toroidal coils has been increased four times since use of the guard.

## Testing Transistors in Mass Production

AN ENDLESS-BELT burning-in test set developed in Philco's Lansdale, Pa. plant handles several hundred surface-barrier transistors at a time. Sockets for the transistors are mounted on the moving belt and connected through wiping contacts to the power supply. As each

row of sockets in turn moves through a window in the console, the operator removes burned-in transistors and loads in new ones.

Meters on panels indicate transistor condition and permit setting up for initial operating values. Each socket is associated with two



# Textolite® COLD PUNCH 11570

a laminate  
for today's  
automation  
trends...

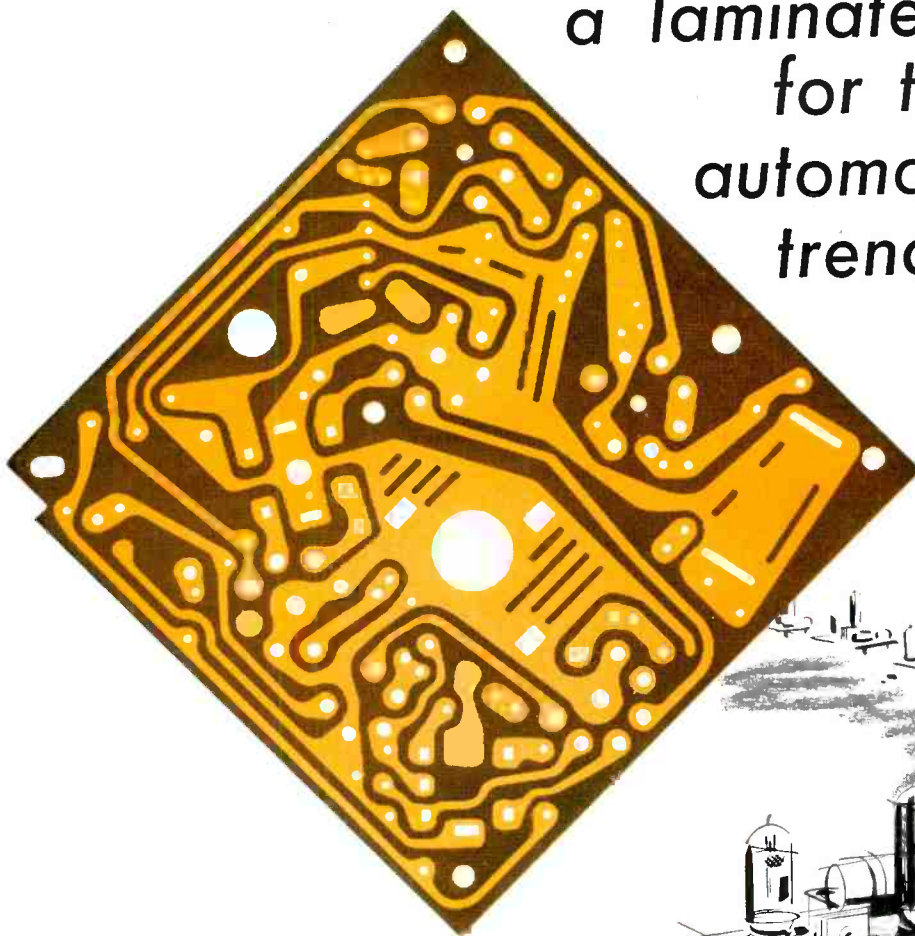

## new precision registry for printed circuits

G-E TEXTOLITE Cold Punch 11570, a phenolic paper-base laminate, adds new concepts to mechanized printed circuitry. This high insulation resistance XXXP laminate can be punched at normal room temperatures—eliminating dimensional changes in the material, as is the case of grades that are heated prior to punching.

The cold fabricating quality of G-E TEXTOLITE 11570 makes possible precision registration of printed circuits, and affords manufacturers the opportunity to use automatic assembly equipment in mounting components.

Other outstanding features of G-E TEXTOLITE 11570 include high flexural strength, very low power factor, high heat resistance, and optimum uniformity. The translucency of TEXTOLITE 11570 permits a visual check for accuracy of circuit registration.

This new G-E TEXTOLITE Cold Punch 11570, with superior electrical and mechanical properties, now offers new opportunities to electrical and electronic manufacturers.

*Progress Is Our Most Important Product*

**GENERAL  ELECTRIC**

G-E Textolite® Laminated Sheets, Rods & Tubes •  
Irrathene® Irradiated Polyethylene • Silicone Insulation •  
Mica and Mica Mat Insulation • Insulating Varnishes •  
Varnished Cloth and Tapes • Sealing and Filling Compounds •



*when the properties have to be right  
specify G-E Textolite*

SEE THE DISPLAY OF G-E TEXTOLITE COLD PUNCH 11570  
AT THE IRE SHOW BOOTH 526-530—KINGSBRIDGE ARMORY

General Electric Company  
Laminated and Insulation Products Department  
Section EL-106, P. O. Box 5911, Cleveland Ohio

- ( ) Please send me your new booklet,  
"A Laminate for Automation."  
( ) Please have your representative call.

Name \_\_\_\_\_

Firm \_\_\_\_\_

Street \_\_\_\_\_

City \_\_\_\_\_ Zone \_\_\_\_\_ State \_\_\_\_\_

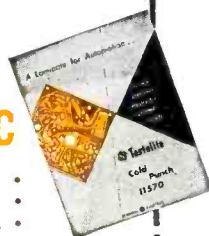

# NOW!

## Flexible Kel-F PRINTED CIRCUIT CABLES

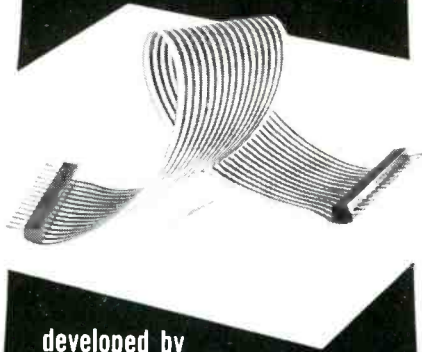

developed by  
Sanders Associates, Inc.

By means of an exclusive Sanders process, the versatile plastic Kel-F can now be laminated with copper in thin sheets to provide a flexible printed circuit cable. This unique development introduces an entirely new concept in the fabrication of multi-conductor cables or wiring harnesses. Excellent electrical and mechanical properties are supplied for operation over a wide range of environmental conditions. The complete encapsulation of the conductors in Kel-F ensures maximum protection against moisture. Glass cloth can also be included in the laminations for increased strength and high temperature stability.

### FEATURES

- Excellent dielectric strength
- High degree of flexibility
- Lighter, thinner than many cables
- Maximum environmental protection
- Adaptable to many connectors
- Multi-layer construction available
- Suitable for chassis harnesses
- Wiring errors are eliminated
- Easily mounted

Write for engineering bulletin to Dept. E-10



Want more information? Use post card on last page.



Conveyorized burning-in test set, with operator inserting transistor leads in socket on endlessly moving belt

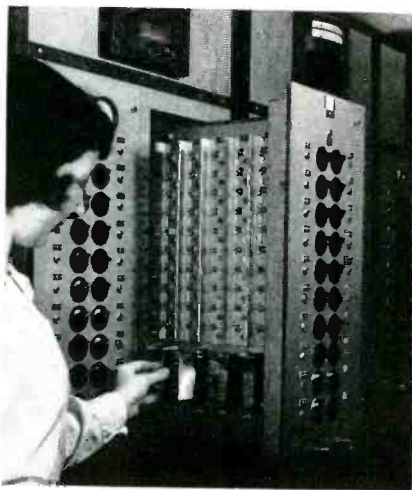

Life test rack, with operator inserting plug in socket holding ten transistors

control knobs on the conveyor, for bringing initial current conditions within tolerance limits where necessary. Units receive 2 hours of aging

## Checking Thickness of Stator Plates

ASSEMBLED SILVER-PLATED stators for military electronic equipment are checked for thickness of individual plates at Radio Condenser Co., Camden, N. J. with the aid of a special pivoted fixture mounted on a Shadowgraph master gage made by Sheffield Corp., Dayton.



Characteristics test set for finished transistors

under load. On typical SBT units the load is adjusted for an emitter current of 3 ma.

Transistors are life-tested on a sampling basis with a rack setup having facilities for handling 9,600 units at a time. The transistor leads are welded to the terminals of an Amphenol socket that holds ten transistors at a time and the socket is then plugged into position on a pull-out drawer of the life test rack. A potentiometer is provided on the drawer for each transistor to permit individual setting of emitter current.

The compartments in which the transistors are life-tested have automatic temperature controls which can provide steady-state ambients at any specified temperature up to approximately 110C or cycle through various ambient temperatures.

Final characteristics of surface-barrier transistors are checked on a universal test set design that measures both input and output leakage, output impedance and alpha at several different operating voltages. Results serve as the criterion for final sorting of resistors as to type.

To check the thickness of a plate, the operator brings it between the projecting anvil of the gage and the pivoted moving member. The sensing rod of the gage rests on the opposite end of the moving member and actuates a vane moving through a beam of light, to give an



**Type ML-6A.** This unit is identical to Type ML-6 except that it is provided with pins of large diameter. See drawing.  
Pin diameter:  $.093 \pm .002$   
Pin length:  $.400 \pm .030$



**Type ML-10.** Range: 15.0–50.0 mc. Supplied per mil type CR-24 when specified.  
Pin diameter:  $.062 \pm .002$   
Pin length:  $.188 \pm .005$



**Type ML-14.** Range: 3.0 mc–75.0 mc. Identical in performance to Type ML-6 except for height of the metal can.  
Pin diameter:  $.050 \pm .002$   
Pin length:  $.238 + .010 - .015$



**Type ML-6.** Range: 1.0 mc–125.0 mc. Supplied per mil Type CR-18, CR-19, CR-23, CR-27, CR-28, CR-32, CR-52, CR-54, CR-33, CR-35, CR-36, CR-48 when specified. Hermetically sealed metal holder with glass and metal base.  
Pin diameter:  $.050 \pm .002$   
Pin length:  $.238 + .010 - .015$

## Midland CRYSTALS pay off in plus performance

Accuracy...uniformity...stability under toughest working conditions. Everything you want in a crystal is guaranteed you by Midland's Critical Quality Control. It's the system of checks and tests that guards the quality of every Midland crystal from selection of the raw quartz to final sealing of the unit.

Midland makes more frequency control crystals than anybody else. Only a product of the highest quality rates that kind of demand. That's why with Midland crystals you can be sure of the finest in frequency control.

Our engineering staff is ready to help you with any crystal problem, including development and production of specials for individual requirements.

**Type ML-6W.** Range: 2.0 mc–75.0 mc. Same as Type ML-6 except wire leads are provided, eliminating the need for a crystal socket.  
Pin diameter:  $.030 \pm .002$   
Pin length:  $2.000 \pm .250$



**Type ML-4.** Range: 2.0 mc–10.0 mc. Supplied per mil Type CR-5, CR-6, CR-8, CR-10 when specified. Holder is phenolic, gasket sealed.  
Pin diameter:  $.093 \pm .002$   
Pin length:  $.400 \pm .030$



**Type ML-5.** Range: 80–200 Kc. Black phenolic holder—gasket sealed. Wire-mounted, silver-plated. The three pin base fits standard 3-pin mounting socket.  
Pin diameter:  $.156 \pm .003$   
Pin length:  $.594 \pm .032$



**Type ML-1A.** Range: 2.0 mc–15.0 mc. Supplied per mil Type CR-1A when specified. Holder is phenolic, gasket-sealed.  
Pin diameter:  $.125 \pm .005$   
Pin length:  $.625 \pm .030$



**Type ML-13.** Range: 90 Kc to 300 Kc. Hermetically sealed. Can is taller to accommodate the low frequency crystal blank.  
Pin diameter:  $.050 \pm .002$   
Pin length:  $.238 + .010 - .015$



**Type ML-171.** Range: 1.5 mc–10.0 mc. Black phenolic holder. Pressure mounted, stainless steel electrodes. Banana plug pins.  
Pin diameter: Not Applicable  
Pin length:  $.850$

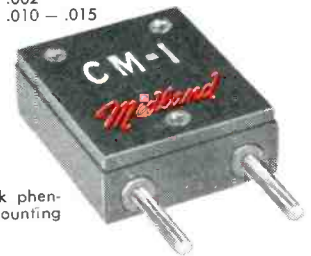

**Type CM-1.** Range: 1.0–15.0 mc. Black phenolic holder. Fixed airgap or pressure mounting with stainless steel electrodes.  
Pin diameter:  $.125 \pm .005$   
Pin length:  $.656 \pm .030$



**Type ML-1G.** Range: 10.0–150.0 mc. Especially adapted to limited-space assemblies. Provided with two wire leads, eliminating need for a crystal socket. All glass, hermetic seal. No grounding problems.  
Pin diameter:  $.018 \pm .002$   
Pin length:  $1.625 \pm .125$



**Type ML-2G.** Range: 200 Kc–150.0 mc. An all glass 7-pin miniature of the same dimensional proportions as the 2AK5 miniature receiving tube.  
Pin diameter:  $.040 \pm .002$   
Pin length:  $.250 \pm .030$



**Type ML-18.** Range: 5.0 mc–150.0 mc. This unit is a metal counterpart of the ML-1G. Hermetically sealed holder with glass and metal base. Available with fixed pins if desired instead of the wire leads illustrated here.  
Pin diameter:  $.040 \pm .002$  Pin length:  $.234 \pm .030$   
Wire:  $.017 \pm .001$  Dia. by  $1.500 \pm .062$  long



**ML-300 Series**  
For color television. All-glass. 7-pin base ideal for printed circuits.

## THE Midland MINIATURE SERIES

... for every crystal application

Developed to serve the growing trend to miniaturization, Midland miniatures are now available for every crystal need, including color television. They'll do an outstanding job for you.

Whatever your crystal need—conventional or highly specialized—when it has to be exactly right, contact Midland.

FAST SERVICE on many regular stock types, available from inventory or on short order.



WORLD'S LARGEST PRODUCER OF QUARTZ CRYSTALS  
...every one produced to the industry's highest standards.

# Are you getting FULL VALUE from your Silver and Gold waste?

**IF YOU USE SILVER OR GOLD ALLOYS**, there's a simple way to find out if you are recovering the full precious metal value in the scrap, sweeps, solutions or other forms of waste from operations in which the alloys are used... *send your next accumulation of waste to Handy & Harman for refining.*



Handy & Harman's time-proven metallurgical processes, super-accurate equipment and fool-proof controls, put refining on the same basis of precision and certainty as a regular manufacturing operation.



Method of using gage to check average thickness of individual silver-plated plates in assembled stator

indication on a ground glass screen. The tolerance required in oscillator plate thickness is 0.0001 inch and for other plates it is 0.0005 inch. Tolerance is measured in increments of 0.0001 inch on all plate thicknesses, to permit matching plates for nominal capacitance. The gage is checked at regular intervals for accuracy with precision honed standard gages.

## Building Wire Harnesses on Mass-Production Line

By **GEORGE SCHUPLIN**  
AC Spark Plug Division  
General Motors Corp.  
Flint, Michigan

MASS production techniques have been applied to the manufacture and checking of wire harnesses used in complicated electronic fire control and navigational equipment.

► **No Hand Carrying**—A standard monorail conveyor eliminates the need for hand carrying of stock from work station to work station and provides a means for storing wires that are in process. Hooks are provided on each hanger to hold individual groups of conductors as they are carried from the

**AT HANDY & HARMAN** there's no guesswork about the silver and gold content of the waste. Refining is done on the same scientific basis as our fabrication of silver brazing alloys and other silver and gold compositions. Each form of waste is processed by a metallurgical method specially developed for that form. These methods, supplemented by over half a century of refining experience, assure the recovery of *every fraction of precious metal value* each lot contains.

**SHIP YOUR NEXT LOT TO US** and see the difference *scientific refining* can make in your returns.



## HANDY & HARMAN

GENERAL OFFICES: 82 FULTON STREET • NEW YORK 38, N. Y.  
Bridgeport, Conn. • Providence, R. I. • Chicago, Ill. • Los Angeles, Calif. • Toronto, Canada

SHIP REFININGS TO THE NEAREST OF THESE PLANTS

WEST COAST  
3825 Medford St.  
Los Angeles 63, Calif.

CENTRAL U. S.  
1900 West Kinzie St.  
Chicago 22, Illinois

82 Fulton St.  
New York 38, N. Y.

EAST COAST  
Bridgeport 1,  
Connecticut

425 Richmond St.  
Providence 3, R. I.

# ★ Control Components Digest ★

News and notes on resistors, rheostats, relays, motor controls, dimmers and other control components

## NEW! MINIATURE RESISTOR for MINIATURE EQUIPMENT

**New Ward Leonard 3-watt wirewound fills need for high-stability, space-saving power resistor**

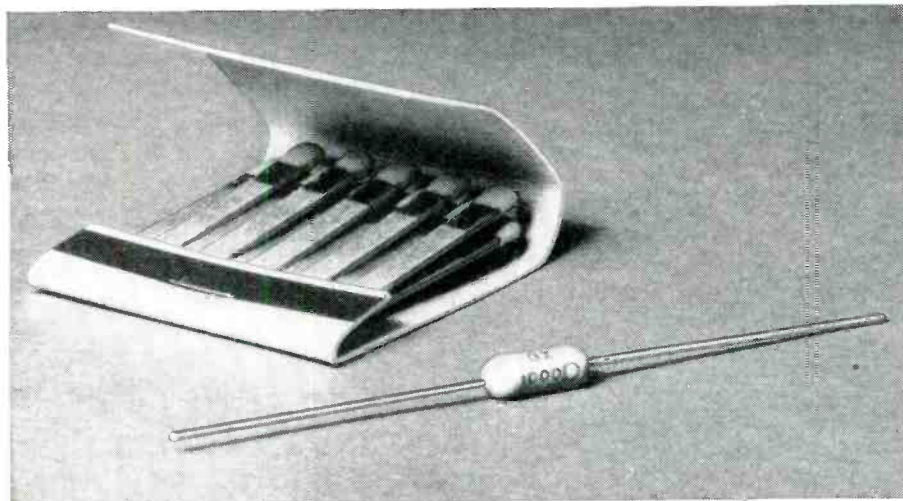

NEW WARD LEONARD TYPE 3X Resistor

A 3-watt wirewound with the compactness of an ordinary 1/2-watt composition resistor—that's what Ward Leonard's new Type 3X Axiohm resistor gives you!

This new resistor now makes it practical to specify a wirewound resistor for your transistorized, printed-circuit, or other miniaturized designs. You get the wirewound resistor's drift-free stability, low voltage coefficient, and high overload capacity in a tiny package.

Type 3X Axiohms, like larger Ward Leonard Axiohm resistors, are wound with special alloy resistance wire on tough miniature ceramic cores. Temperature coefficient of resistance is exceptionally low.

Resistance wire and axial leads are spot-welded to end caps, insuring a strong, permanent, low-resistance bond.

The entire resistor assembly is encased in Vitrohm enamel forming a hard, crazeless, heat-conducting hermetic seal. Leads are tin-dipped for fast soldering. No mounting hardware is required. Conservative 3-watt rating is based on 300°C rise, 40°C ambient.

Order these resistors by type number (3X) and resistance value (see table at right).

### STOCK VALUES, TYPE 3X

Value* (Ohms)	Current (ma)	Value* (Ohms)	Current (ma)
1	1732	400	87
1.5	1413	450	82
2	1226	500	78
3	1000	600	71
4	866	700	66
5	776	750	63
7.5	632	800	61
10	548	900	58
12	500	1000	55
15	447	1100	52
20	387	1200	50
25	346	1250	49
30	316	1500	45
35	293	1750	42
40	274	2000	39
50	245	2250	36
75	200	2500	35
100	173	3000	32
125	155	3500	29
150	141	4000	27
200	123	4500	26
225	116	5000	25
250	110	6000	22
300	100	6500	21
350	93	...	..

\*Resistance tolerance  $\pm 5$  percent

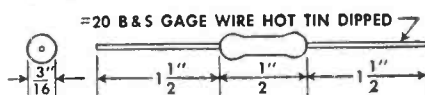

DIMENSIONS, Type 3X Resistor

### You can still get 5- and 10-watt Ward Leonard miniatures

Ward Leonard 5- and 10-watt Axiohms have proved themselves in business machines, guided missiles, computers, communications equipment, and many other electronic and electrical devices. They have the same wirewound construction as the new miniature 3X resistor—differing only in size and wattage rating.

You'll find complete specification data on these larger miniature resistors in Ward Leonard's information-packed Catalog 15. (Complete data on the 3-watt unit will be found in Catalog 15, Supplement B.)

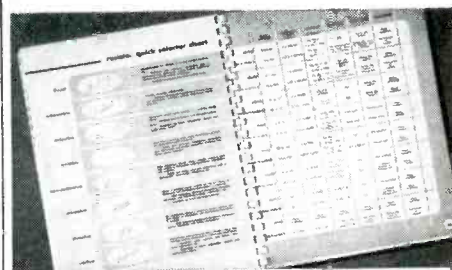

WARD LEONARD CATALOG 15. Sixty-five pages of data help you select the right resistor for any job.

### And big ones, too!

Ward Leonard Vitrohm resistors are available in stock sizes up to 200 watts. Similar resistors up to 550 watts are made on special order. You'll find these power resistors in a wide variety of mounting styles and types, tapped, untapped and regular or non-inductive wound, described in our big Catalog 15. Write for your copy today. 6.9

**WARD LEONARD ELECTRIC COMPANY**  
31 SOUTH ST., MOUNT VERNON, N. Y.



Result-Engineered Controls Since 1892

RESISTORS • RHEOSTATS • RELAYS • CONTROLS • DIMMERS

# **NEW** **CONICAL BRUSHES** **STRIP CLOSER**

- Effective — strips within 1/8" of coils, components
- Convenient — hand type unit for production-line work
  - Compact — light weight, easy to handle
- Efficient — strips all kinds of film type insulation

## **IDEAL** TWIN-CONE *strippers*

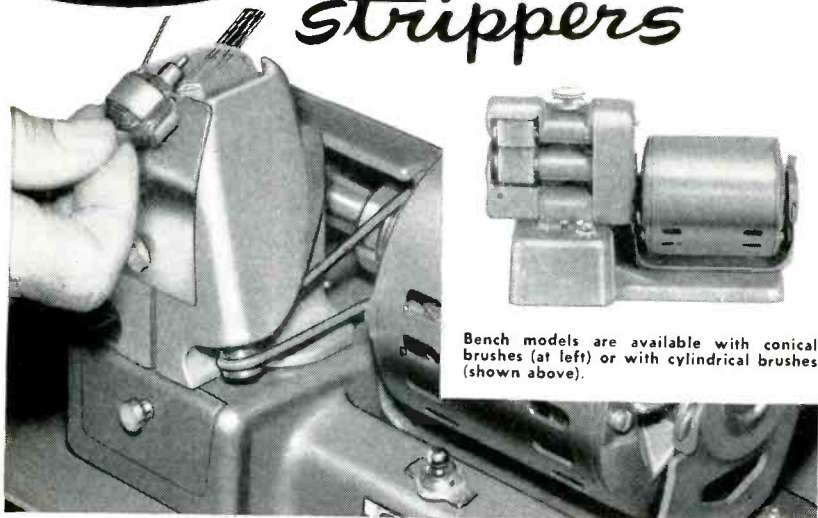

Bench models are available with conical brushes (at left) or with cylindrical brushes (shown above).

IDEAL's new TWIN-CONE wire strippers are compact, sturdy—truly precision-built production tools. They were designed to do a clean, efficient job of stripping fine wires on the highest speed production-line basis. The flexible shaft hand type unit is particularly adapted to all types of wire stripping at coil winding stations. All models are electrically powered — motors operate on 115-V. AC or DC current.

### LONG LIFE BRUSHES

Ideal strippers have long life, easily dressed, fibre glass brushes in conical or cylindrical shapes.

### FAST, SURE, POSITIVE

Quickly removes all types of film insulation from AWG #25 to AWG #50 wires. Eliminates rejects due to broken leads.

### NEW EFFICIENCY

Ideal Twin-Cone strippers provide brighter, oxide-free wire surfaces for better, more positive contacts.

### TWO STYLES AVAILABLE

Take your choice between portable flexible shaft hand-type units or bench-mounted models to suit the needs of your exact requirements.

**MAKE A FREE TRIAL TEST**

Send us a sample of your particular wire stripping problem. We'll make tests and send you our recommendations. No obligations, of course!

IDEAL INDUSTRIES, INC.  
1055 Park Avenue, Sycamore, Illinois  
Gentlemen:

Kindly send us complete catalog data on Twin-Cone and Twin-Wheel production strippers.

Herewith a sample of our wire stripping needs, kindly send us your recommendations and data.

Name \_\_\_\_\_

Company \_\_\_\_\_

Address \_\_\_\_\_

City \_\_\_\_\_

Zone \_\_\_\_\_ State \_\_\_\_\_



# IDEAL



Loading all wires for a particular harness in kit box having numbered bins

cutting machine to each work station.

Each harness has its own individual color, so an operator can look up and tell immediately where the next wires are. The conveyor is so arranged that every six minutes a complete cycle is made by each harness board and work station.

The work stations are laid out on a progressive basis. One operation falls in line behind the other. That way once the wire starts in on the line it is complete when it arrives at the sorting station.

► **Cards Tell All**—Conductor cards have been developed showing all pertinent data for each wire. This includes size of wire, length, color and termination numbers. The cards are kept in groups by harness numbers and are sent to the cutting station in that manner. An Artos cutting machine is used for cutting wire to length and also for stripping insulation in one operation. Nylon-jacketed wire requires a hand



Bench fixture holds three Amphenol plug assemblies at a time for prefabrication to eliminate need for soldering during harness assembly





*It's New...!*

# A MYLAR\* dielectric capacitor MOLDED IN EPOXY

The superior moisture resistance of EPOXY gives far better humidity protection than commonly used molding materials. High dielectric strength is also an attractive property of this tough, dense plastic.

Exclusive Good-All molding technique eliminates all possibility of deforming or otherwise damaging windings during the molding process. Uniform wall thickness is carefully maintained.

**600-UE**

Leads are securely bonded in the EPOXY molding compound. This extremely tight bond prevents moisture from entering the capacitor at this point.

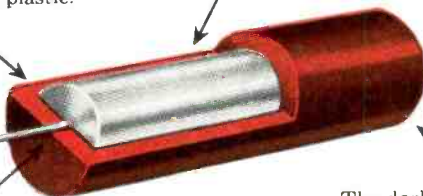

The dark maroon capacitor body is exceptionally durable as well as attractive.

Since overall dimensions are held within close tolerances, this capacitor type is ideal for automatic machine insertion.



**600-UPE**

The same quality features illustrated in the cut-away drawing are available in *Pin Types* for use in upright mounting.

## GOOD-ALL TYPE 600

The outstanding combination of a space-saving Mylar winding sealed in moisture resistant EPOXY provides you with premium performance in a rugged compact design. This new capacitor incorporates these valuable properties of Mylar dielectric . . . HIGH IR, STABILITY WITH LIFE and LOW POWER FACTOR. Good-All Types 600-UE and 600-UPE (for upright mounting) are priced to encourage widespread use in both consumer products and industrial equipment.

\*DU PONT'S TRADEMARK FOR POLYESTER FILM.

### SPECIFICATIONS

- Insulation Resistance** . . . Greater than 75,000 Megohm-Mfd. at 25°C (See curve below for higher temperatures)
- Power Factor** . . . Less than 0.5% from +25°C to +85°C
- Temperature Range** . . . May be operated at rated voltage from -65°C to +85°C and to +125°C with derating
- Humidity Resistance** . . . Far surpasses requirements of RETMA Spec. REC-118-A
- Voltage Range** . . . 100, 200, 400 and 600 Volts D.C.

INSULATION RESISTANCE vs. TEMPERATURE

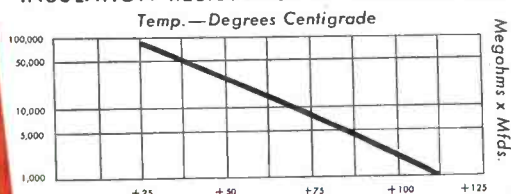

DIMENSIONS OF TYPE 600-UE, 100 VOLTS D.C.

CAP.	SIZE	CAP.	SIZE
.015	.312 x 15/16	.15	.500 x 1 3/16
.047	.375 x 1 1/16	.22	.500 x 1 9/16
.1	.438 x 1 3/16	.47	.562 x 1 15/16

**Paper Dielectric capacitors are also available in molded Epoxy Types**

*Our engineers are ready to work with you on special applications. Write or wire for specifications and quotations.*



**GOOD-ALL ELECTRIC MFG. CO. • OGALLALA, NEBRASKA**

*A leading manufacturer of Tubular and Ceramic Disc Capacitors*

# UNION

## "Selenium Slim" Rectifiers 10,000 hours of service— but no service calls!

UNION Selenium Rectifiers are used in the Series 3000 Portable DC Overpotential Tester produced by the Beta Electric Corporation, New York. Here's what Dr. Victor Wouk, Director of Engineering, says about them:

"The UNION selenium rectifiers are virtually indestructible mechanically, and have an operating life well in excess of 10,000 hours. They have proved themselves repeatedly *since we have*

*yet to receive a single service call for a rectifier failure!*

"The Beta Overpotential Testers were designed to check generators, motors, power cables, etc. in preventive maintenance programs. It was necessary to provide a compact, lightweight, reliable, high-voltage DC insulation testing unit for operation under difficult conditions in the field. 'Selenium Slim' Rectifiers made it possible to meet these requirements."

Standard UNION selenium rectifier cells, pencil type, range in size from  $\frac{1}{8}$ " to  $\frac{1}{2}$ " diameter, rated from 2.5 to 40.0 milliamperes per cell; and stack-type, 1" x 1" to 5" x 6", rated from .180 to 10.0 amperes per cell in a single-phase full-wave bridge basis. Special combinations can be made to fit practically any current and voltage conversion requirements in various housings and special shapes. Write for complete information.

Beta Electric Corp.  
Model 3060-1R  
High Voltage Section

SELENIUM RECTIFIERS

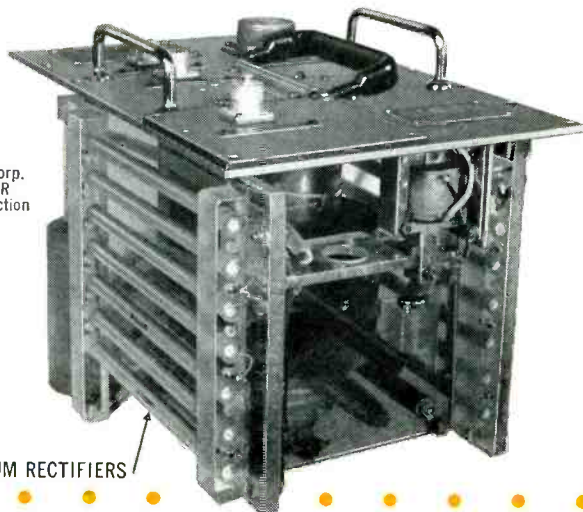

Quality First... TO LAST

Note UNION "Selenium Slim" Rectifiers in the Beta Overpotential Tester. Output voltages 0-60 KV.

75 Years

1881



1956

OF EQUIPMENT AND SYSTEMS ENGINEERING . . . . .

UNION SWITCH & SIGNAL

DIVISION OF WESTINGHOUSE AIR BRAKE COMPANY  
PITTSBURGH 10, PENNSYLVANIA

PRODUCTION TECHNIQUES

(continued)

stripping operation to remove the nylon from the insulation.

► **Wire Preparation Line** — Cut wires are placed on the conveyor along with the conductor card and are carried around to the wire preparation line. Here the wires move in sequence from a ferruling station to termination marking, tinning, lugging and sorting stations.

When the wire reaches the sorting station, the wires are placed

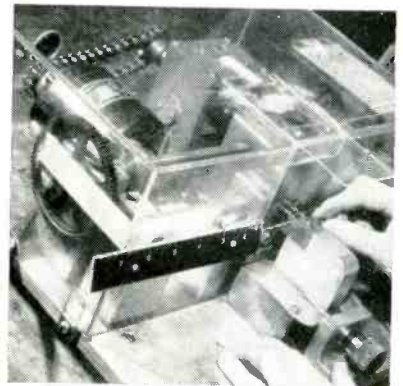

Motorized stripper has rotary blades that cut woven shield without damaging insulation, when wire is rotated in anvil as shown

in slanted storage racks preparatory to distribution to kit boxes made up for each harness assembly number. Wires are then split. Those for plug assemblies go into separate boxes and those for harnesses into others. The boxes are then placed back on the conveyor and are sent around to the operators who make up the plug assemblies.

All Winchester and Amphenol plug assemblies are prefabricated so intricate soldering jobs do not have to be done on the harness boards. Upon completion, plug assemblies are inspected and then placed back on the conveyor ready for assembly into harnesses.

A special stripper for removing the woven shield from wire also has been devised. By use of rotary blades, the shielding is cut through at the proper place and then removed from the wire.

► **Fast-Check Board Design** — Unique harness boards were developed to be used in conjunction with an automatic hi-pot and continuity

## Silastic Impregnated Sleeving Insulates Lead Wire In Strip Heater

Braided glass sleeving impregnated with Silastic, Dow Corning's silicone rubber, retains excellent flexibility and insulating effectiveness at temperatures that cause rapid failure of organic electrical insulating materials. The advantages of such sleeving are demonstrated in the small strip heaters manufactured by Watlow Electric Co., of St. Louis.



Not much larger than elbow spaghetti, these efficient 175 watt heating units are used by aircraft builders and other metal working companies

to heat aluminum during dimpling or countersinking to provide flush mounting of rivets. Most aluminum alloys cannot be formed cold without setting up stresses.

Slipped over the dimpling die-tips, the heaters produce temperatures of 500 F and higher. The lead wires flex continually with movements of the die. To protect the lead wire with a high dielectric strength material that retains good flexibility at high temperatures, Watlow uses Turbo 117, a Silastic impregnated sleeving fabricated by The William Brand Co. Watlow reports silicone insulated sleeving has substantially reduced lead wire failures. **No. 27**

## CLASS H MOTOR STILL ON TEST AFTER 58,090 HOURS AT 240 C

At 10 A.M., June 6, 1946, a Class H insulated 10 hp motor was generator loaded to operate at its test temperature of 240 C in Dow Corning's motor test labs. Every 500 hours since it has been shut down and exposed to 100% relative humidity for 24 hours. As of 11 A. M. July 1, 1956, this motor was still on test after 58,090 hours at an average copper temperature of 240 C! That's equivalent to 353 years operation at the Class H temperature of 180 C.

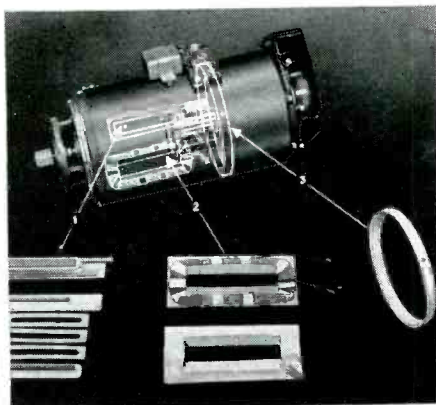

Silicone-glass components: 1. interpole insulator; 2. shunt field coil insulator; 3. insulator ring.

## SILICONE-GLASS LAMINATES CUT SIZE OF TURBOJET GENERATOR

By utilizing the superior thermal stability and dielectric strength of silicone-glass laminates, Red Bank Division of Bendix Aviation Corporation has designed new compactness and efficiency into a generator that meets the rugged requirements of turbojet operation.

This Type 30E10-1 Generator, a 30-volt 400 amp unit, is 6½ inches in diameter and weighs only 67 pounds. Developed to operate at speeds as high as 8000 rpm and for air-blast cooling at altitudes up to 65,000 feet, it features light weight insulating components formed of 2-ply silicone-glass cloth fabricated by Stevens Products, East Orange, N. J.

The extremely thin-walled construction of these parts provides more space for circulation of cooling air than possible with the several layers of tape conventionally used. In addition, the silicone-glass laminates are lighter in weight than the tape insulation. Quickly "snapped" into place, they effect substantial savings in assembly time and costs. **No. 28**

"Potting Gives Maximum Reliability", an article from ELECTRONIC EQUIPMENT, describes the method of encapsulating a new series of electronic devices developed by the Naval Ordnance laboratory. Using silicones helps to provide the utmost protection against mechanical and thermal shock, vibration, and humidity. **No. 29**

Documentary film "What's a Silicone?" available free of charge for showing to technical audiences. For more information circle **No. 30**

## Waterproof Wire Splice With Silicone Compound

The sales success of "Super-Splice", designed by Superior Cable Corporation, Hickory, N. C., testifies to the superior dielectric properties of Dow Corning silicone compound. Over 2,000,000 of the splices have been sold in the last two years.

Originally developed for telephone cable work, the "Super-Splice" is a simple polyethylene sleeve sealed at one end and filled with grease-like Dow Corning silicone compound. It is quickly and easily slipped over twisted pigtails to form a splice that retains optimum electrical insulating properties despite prolonged exposure to moisture.

Extensive laboratory tests have proved that "Super-Splice" retains its full insulating effectiveness even after a full year under water. During these tests, splices featuring polyethylene-insulated wire protected with silicone-filled "Super-Splice" withstood

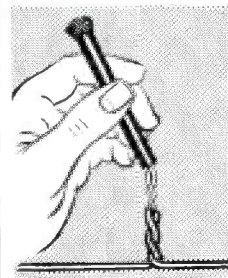

45,000 volts dc and measured 200,000 megohms insulation resistance while immersed in water.

Since the silicone compound does not harden with aging, the insulator may be removed at any time to facilitate maintenance. "Super-Splices" now available are 2½" long and are suitable for straight, butt or bridge splices of 19, 22 or 24 gauge wire. **No. 31**

**Send Coupon for More Information**

**DOW CORNING CORPORATION - Dept. 4810**  
Midland, Michigan

Please send me **27 28 29 30 31**

NAME \_\_\_\_\_

TITLE \_\_\_\_\_

COMPANY \_\_\_\_\_

STREET \_\_\_\_\_

CITY \_\_\_\_\_ ZONE \_\_\_\_\_ STATE \_\_\_\_\_

# electronic counter

CAT. NO. — NE — 14-20 FM

**ACCURATE • DIRECT READING  
INSTANTANEOUS • SIMPLE  
RELIABLE**

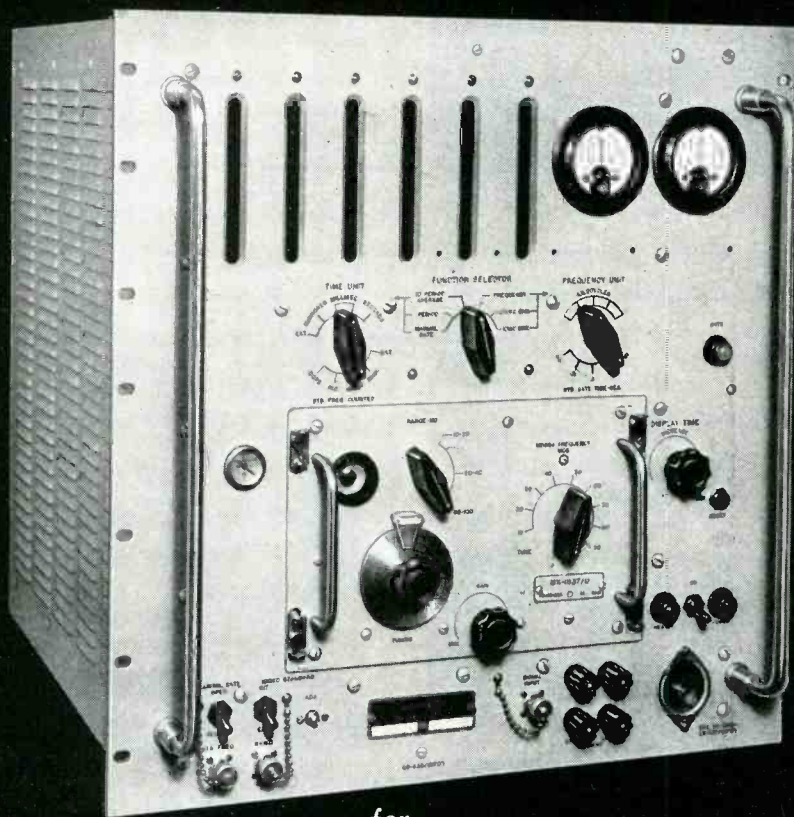

for

**FREQUENCY MEASUREMENTS  
10 CPS TO 220 MC;  
TIME INTERVAL 1 MS TO  
100 DAYS; PULSE LENGTH,  
REP, RATES, FREQUENCY DRIFT**

**northeastern**



**engineering**

Manchester

New Hampshire

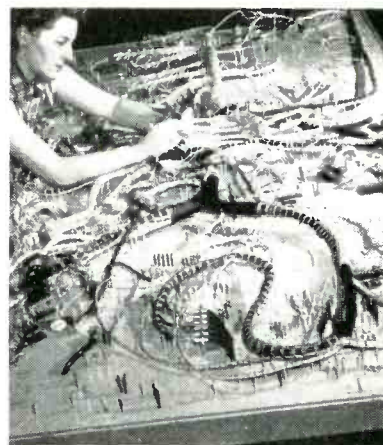

Harness board containing over 1/4 mile of wire, designed for use with automatic hi-pot checker

checker. These boards are made by cementing a blueprint of the harness to a sheet of plywood, then covering it with 3/8-inch Lucite. Terminal boards and mating plugs are fastened into their proper places. Zinc-plated cotter keys are pounded into drilled holes and the ends cut off from underneath.

On the side of the board, Winchester type 75 terminal blocks are installed. Wires are then run from each terminal to each termination point on the underside of the board. Each circuit then is in a position to be checked automatically.

Wires are laid out in sequence on the harness boards. Use of this system allows use of the prefabricated wire lengths as each harness is uniform in regard to shape and placement of wire. On larger boards, up to 7 feet long, teams of operators are used to build these harnesses. Wires are laid out in position, then checked for continuity by use of a separate fast-check continuity checker. This fixture contains a 75-position stepping

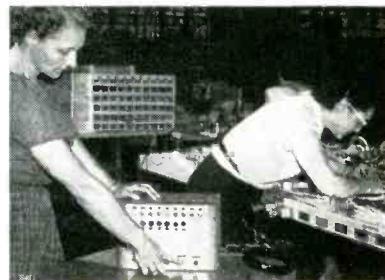









Fast-check continuity checker being used to make sure wires are in proper positions on board before lacing

# You can get **ALL** your **MIL-C-25A** Capacitors from **AEROVOX**

*Now* ... all your requirements for MIL-C-25A capacitors can be obtained from **ONE** source ... **AEROVOX**. No need to waste valuable time shopping around for approved sources when you can get quality and service automatically from **AEROVOX**.

Keep this handy reference chart for use in selecting your MIL-C-25A capacitor requirements. Remember ... always order by MIL-C number.

MIL-C-25A NO.	CASE STYLE	REMARKS	MIL-C-25A NO.	CASE STYLE	REMARKS
CP04 - CP05 - CP08 - CP09 - CP10 - CP11 -		Ratings 100-600 VDCW, available with insulated bodies, tangential brackets and threaded terminal mountings.	CP67 - CP69 -		Ratings 600-1000 VDCW. Available with top or bottom channel mounting brackets.
CP25 - CP26 - CP27 - CP28 - CP29 -		Ratings 200-1500 VDCW, insulated bodies, radial and tangential mounting brackets available.	CP70 -		Available in ratings from 600-12,500 VDCW. Type CP07 mounting brackets available.
CP40 - CP41 -		Ratings 600-1500 VDCW, grounded or insulated case construction.	CP75 - CP76 - CP77 - CP78 -		Available in ratings from 250-600 VDCW. All units supplied with machine screw stud mounting.
CP53 - CP54 - CP55 -		Ratings 100-1000 VDCW. Available with terminals on top, bottom or side.	CP80 - CP81 - CP82 -		Available in ratings from 400-1500 VDCW. All units supplied with machine screw stud mounting.
CP61 - CP63 - CP65 -		Ratings 400-1500 VDCW. Available with removable mounting brackets or with soldered mounting brackets for top or bottom terminal mounting.			

For special Aerovox types meeting specifications above and beyond MIL-C units listed here write for detailed information.



## AEROVOX CORPORATION

New Bedford, Mass. In Canada: AEROVOX CANADA LTD., Hamilton, Ont.

# Shaker system for complex motion tests

**N**EWEST TECHNIQUE in environmental testing is complex motion testing. It comes closest to reproducing actual vibrational environments encountered in operation of missiles, aircraft, vehicles.

An MB Vibration Exciter System designed for such service is one of optimum versatility. It fulfills not only the special needs of *random motion testing*, but virtually any other test specification as well . . . such as sinusoidal motion testing, fatigue testing, automatic cycling, and provisions of MIL-E-5272A.

## HEART OF THE SYSTEM—THE EXCITER

The MB Model C-25HB (shown) is rated at 5000 pounds peak force. Its table assembly is unusually stiff to reduce resonances yet weighs only 75 pounds. Axial resonance lies well over 2000 cps operating range.

This and other MB Exciters for 200, 1200, 1700, 3500, 7000 and 15,000 pound force ratings faithfully reproduce complex wave input signals because their *frequency response is flat*.

## MATCHED PERFORMANCE

Other elements of the system are integrated with the exciter's high performance. An electronic *amplifier* fulfills the power demands. A control cabinet houses all necessary *instrumentation* plus frequency and amplitude controls. Circuits in a *compensation console* give automatic adjustment so that table acceleration remains proportional to input voltages. A top quality tape recorder for playback of the complex wave patterns may be used.

If you have any questions on vibration testing at all, come to a leading authority on the subject . . . the MB engineering staff.



*manufacturing company*

A DIVISION OF TEXTRON INC.

1060 State Street, New Haven 11, Conn.

HEADQUARTERS FOR PRODUCTS TO ISOLATE . . . EXCITE . . . AND MEASURE VIBRATION

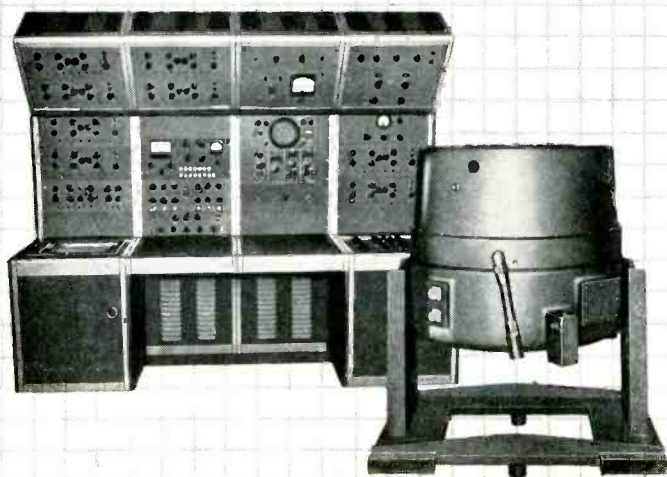

Automatic hi-pot and continuity checker being used for final test of finished harness on special board, to reduce testing time from 40 hours to about 40 minutes for average harness. Unit stops when defective wire is reached

switch wired through a bank of numbered lights. After each wire is determined to be in proper position, the harness is laced. It is then ready to be checked for hi-pot and continuity.

► **Automatic Inspection**—An automatic hi-pot and continuity checker was designed to eliminate hand checking of harnesses. The unit contains master control deck (relays, motor timer and stepping switch) and five decks of 100 relays each, a 1,500-volt power supply and a group of indicator lights. Cables are run from this unit to a table that the harness boards plug into. The design of this unit allows 500 circuits to be checked in approximately 2 hours. Charts are made up for each harness showing termination point to termination point in respect to each light. In this manner, any discrepancies may be located immediately. A smaller unit is also in operation to check harnesses having up to 75 circuits.

## Aluminum Straps Catch Fluorescent Tubes

STRAPS made of scrap aluminum are used by Lenkurt Electric Co., San Carlos, Calif., to insure that fluorescent lighting tubes loosened by vibration will not fall out of fixtures and possibly endanger factory personnel with shattering glass.

The firm uses fluorescent fix-

# Off the Shelf

## AT GUARDIAN FRANCHISED DISTRIBUTORS



a complete line of  
**GUARDIAN** INDUSTRIAL CONTROLS  
now available for immediate delivery!

• WHEN MINUTES COUNT . . . design and production men are gratified to know that quantities of Guardian's complete line of Industrial Relays, Steppers and Solenoids are obtainable *from stock* at Guardian's nearby franchised industrial distributor. In effect, this means that substantial amounts of Guardian Industrial Controls are as close to you as a phone call. Price-wise, they cost no more than production orders shipped direct from the Guardian plant. In-stock products include:

**A.C.-D.C. Relays**—All Purpose Economy, Power, Medium Power, Telephone Type, Powerloid, 32 Pole, Time Delay, Overload, Plate Circuit, H.F., Antenna, Ratchet, Interlock; **Steppers**—Continuous Rotation, Electrical Reset, Add and Subtract, Cycling Ratchet; **A.C.-D.C. Solenoids**—a complete line of Intermittent and Continuous Duty.

*"Everything Under Control"*

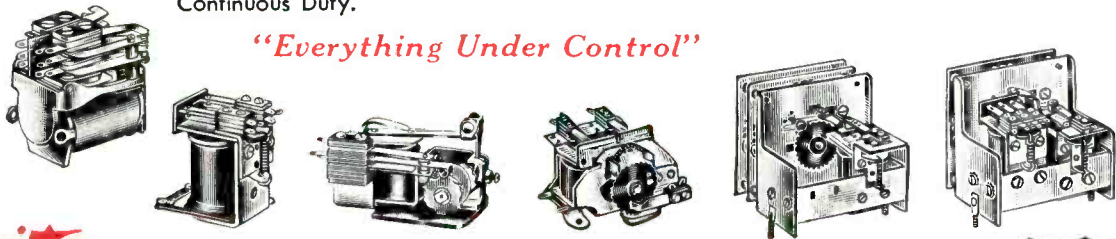
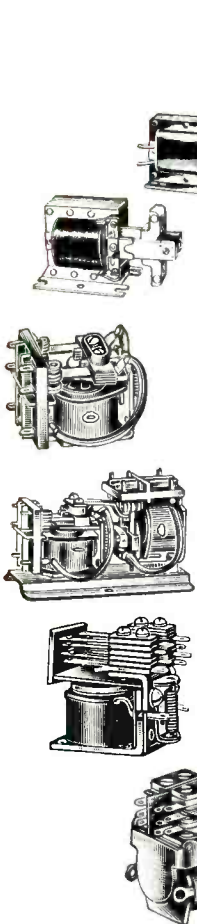

*write* for free bulletin SD-11 and name of nearest Franchised Distributor

# GUARDIAN ELECTRIC

1625-L W. WALNUT STREET

CHICAGO 12, ILLINOIS

A COMPLETE LINE OF CONTROLS SERVING AMERICAN INDUSTRY



# NEW PHAOSTRON EXPANDED SCALE AC Voltmeter

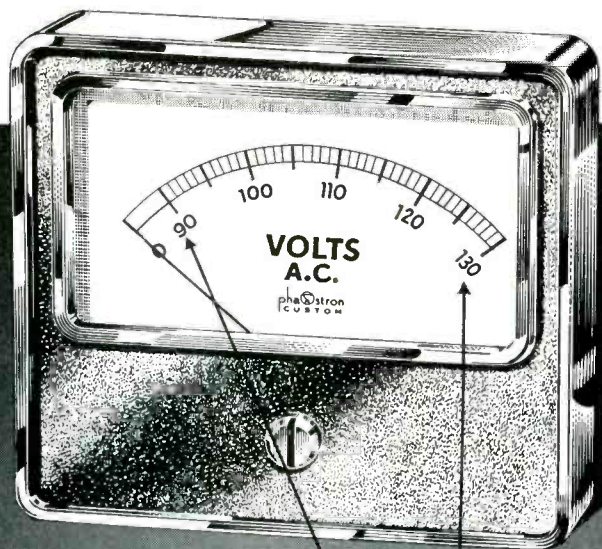

Available now from distributors in 90V to 130V Range, AC Rectifier Type in all custom styles and sizes.

3½" and 4½" rectangular meter

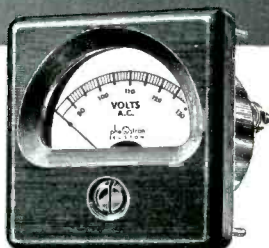
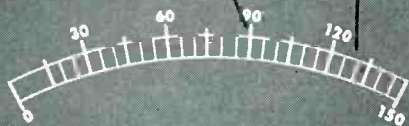

2½" or 3½" square meter

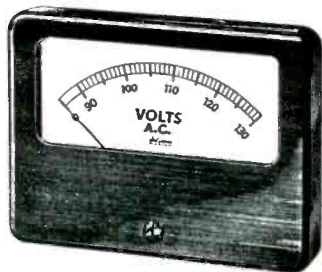

6" rectangular meter

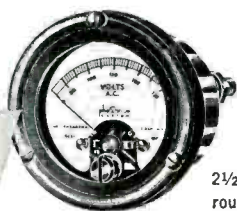

2½" or 3½" round meter

NOW!... all the time-tested proven Phaostron features... PLUS UP TO TEN TIMES GREATER READABILITY for greatly increased accuracy!

Phaostron has squeezed down that under 90V portion of the scale, where you don't need it, and expanded the section where you need it most—between 90 and 130V. Precisely calibrated 1 volt scale increments provide greater reading accuracy. Wide frequency range—linearity—true rms reading and Phaostron craftsman construction.

*Phaostron Custom Panel Meters, with expanded scale, 90V to 130V AC rms, are available in nine types at your Parts Distributor. For special requirements, write to the Product Development Department for practical recommendations.*

## PHAOSTRON

PHAOSTRON INSTRUMENT & ELECTRONIC CO., 151 PASADENA AVE., SOUTH PASADENA, CALIF.



Aluminum straps keep tubes from falling out of fluorescent lighting fixtures. The straps are formed at each end to clamp over the flanged bottom edges of the reflecting hoods.

tures suspended over work benches throughout its factory. At the suggestion of the safety engineer, the maintenance department devised the safety straps from scraps obtained from the sheet metal department, which makes aluminum parts for carrier and microwave radio equipment.

The straps are formed at each end to clamp over the bottoms of the fixtures. If a tube falls out of its sockets, it rests on the straps.

## Tuning Capacitor Soldering Techniques

BOTH TORCH and soldering iron are used for soldering operations required during assembly of rotors and stators for precision gang tuning capacitors made in Radio Condenser Co.'s Camden, N. J. plant for use in military electronic equipment.

A 550-watt soldering iron is used for the purpose whenever possible, because it permits faster soldering than with a gas torch. Because of its size, there are many locations where the tip of an iron of this size cannot be inserted far enough to give adequate heat transfer. Here the gas torch is used.

Regardless of the heating source,



## Rigged for towering performance...

Hailed as exemplifying a revolutionary concept in maritime transportation, the "Clipper" ship developed largely from the design and construction activities of William Webb, noted American shipbuilder and a foremost naval architect of the nineteenth century. Racing close hauled to the wind, their towering masts crowded with sail, these speedy, super-crafted carriers often weighed several thousand tons.

*Wm Webb*

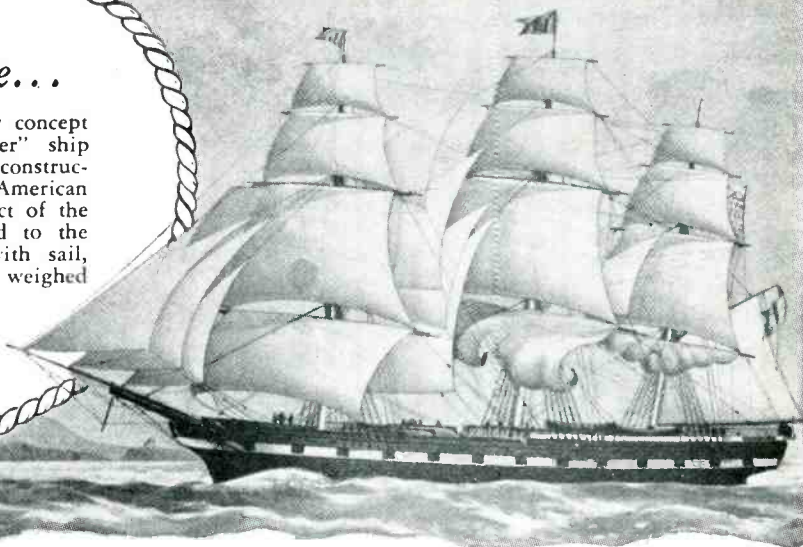

Information and signature courtesy of Webb Institute of Naval Architecture

# MORE PRECISION PER POUND...

## in L BAND Equipment by FXR

(6.660" x 3.410" WG)

FREQUENCY RANGE: 1120 to 1700Mc/s

Containing some of the largest waveguide components to be found in the Microwave testing field, the L Band line is representative of the constant standards of craftsmanship reflected in all FXR products, regardless of size. As a pioneer in waveguide design and fabrication, FXR is maintaining its recognized position of leadership with full production of all items illustrated and listed in this advertisement.

L101A	SLOTTED SECTION	L620A	SERIES TEE
L150B	FLAP ATTENUATOR	L621A	SHUNT TEE
L160B	PRECISION VARIABLE ATTENUATOR	L622A	E/H TEE
L168A	FIXED PRECISION ATTENUATOR	L623A	90° E-BEND
L310A	SLIDE SCREW TUNER	L624A	90° H-BEND
L501A	TERMINATION	L630A	SLIDING SHORT
L502A	SLIDING TERMINATION	L701A	SPECTRUM ANALYZER
L600B	WG-TO-COAX ADAPTERS	L771A	SIGNAL SOURCE

#### ACCESSORIES

B200A	PROBE
N410A	FREQ. METER
Z911A	STAND

NOW AVAILABLE... the new FXR catalog for 1956-57; showing a complete line of precision microwave testing equipment.



**L101A SLOTTED SECTION**  
Slope: less than 1.01 (VSWR)  
Resolution of Vernier Scale: ± 0.1 mm  
Length: 24"

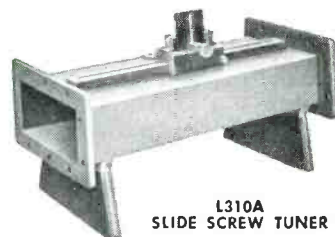

**L310A SLIDE SCREW TUNER**  
Tuning Range: Will match a VSWR of 20 to a VSWR of 1.02 over the freq. range  
Length: 20"



**L160B PRECISION VARIABLE ATTENUATOR**  
Element: Metallized Glass  
Attenuation: 40 db max. over Freq. Range  
VSWR: 1.2 max.  
Dial: Direct reading at one freq.  
Accuracy: ± 0.2 db  
Freq. Sensitivity: Approx. ± 1 db at 30 db  
Length: 30"

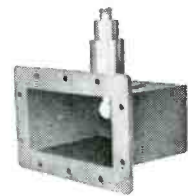

**L600B WAVEGUIDE-TO-COAXIAL ADAPTERS**  
Maximum VSWR: 1.30  
Length: 5-1/4"



FIRST BY FAR

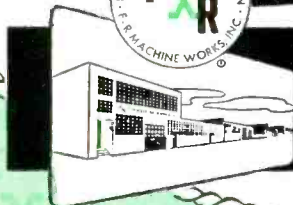

### Electronics & X-Ray Division

F-R MACHINE WORKS, Inc.

26-12 BOROUGH PLACE, WOODSIDE 77, N. Y. • ASTORIA 8-2800

# Twenty-Shilling Munitions Plant

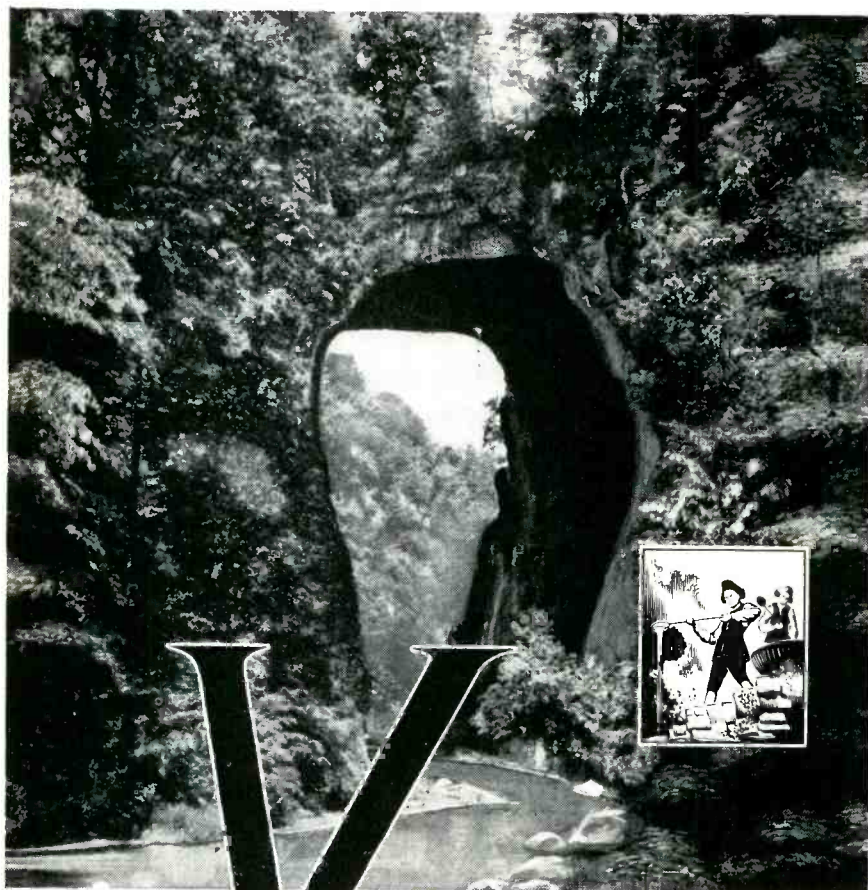

in **VIRGINIA**

Soon after Thomas Jefferson bought Natural Bridge—for 20 shillings—the Colonial troops turned it into a munitions plant. They poured molten lead from the top. As the metal stream fell 215 feet, it broke into bullet-size balls that chilled solid in Cedar Creek below . . . ready to be fired at the Red Coats!

Virginia industrial sites now run a bit more than 20 shillings. But they're still a top bargain. For they hold many a profit advantage for your new plant.

Resources within short haul include coal plus forty other important minerals . . . reserves of both hard and soft

wood . . . and industrial farm products.

Abundant, southern manpower lives and works in a climate that is easy on people as well as on industrial plants. You have ample low-cost electricity, natural gas, fine industrial water. Top rail, highway and air transportation link your plant with the markets of the Northeast, South and Mid-West. And the Hampton Roads harbors put the world at your door.

For confidential facts about available sites in this land of friendly, conservative people and government—write or phone:

## DIVISION OF PLANNING AND ECONOMIC DEVELOPMENT

Virginia Department of Conservation and Development  
State Finance Bldg., Richmond, Va. • Telephone 3-3449

*"Facts Favor Virginia"*



Soldering stators with 550-watt iron after swaging, to make rigid bond between stator plates and stator spacers



Soldering coin silver disks and rotor plates with gas torch after swaging

a Ruby flux is first brushed on. This is nonacidic when cold, but becomes acid, as required for proper cleaning of the silver plating on the tuning capacitor structure, when it boils during soldering.

## Contour Projector Speeds Beam-Tube Inspection

UTILIZATION OF the translucency of mica permits economical 100-percent optical inspection of assembled magnetron beam switching tubes, according to Victor LeGendre, chief engineer of Haydu Brothers,

**FUNCTIONALLY  
VIBRATION-FREE!**

**NEW *Kinney*® MODEL KD-30  
HIGH VACUUM PUMP... IS  
DYNAMICALLY BALANCED!**

If you need *vacuum* in an experimental, pilot plant, or production application, this "dynamically balanced" feature is of vital importance to you and your pocketbook. It means . . .

- A pump ideally suited for portable installations or systems requiring a minimum vibration tolerance factor.
- Increased wear-life of pump components . . . making it a long-term investment.
- A "vibration-free" pump augmented by other Kinney design features, including the Kinney Swirl Separator Tank, Gas Ballasting, etc.
- Further proof of design superiority is shown in the specification data and pumping speed curve. Check these, compare them, and act today to improve your vacuum process.

For superior vacuum equipment, contact the Vacuum Equipment Division of The New York Air Brake Company at address below.

Our engineers will gladly send recommendations on your particular vacuum equipment needs. Request additional data today or contact one of our competently staffed district offices . . . in Baltimore, Charleston, W. Va., Charlotte, N. C., Chicago (La Grange), Cleveland, Detroit, Houston, Los Angeles, New Orleans, New York, Philadelphia, Pittsburgh, San Francisco, St. Louis . . . or The International Sales Office, 90 West St., New York 6, N. Y.

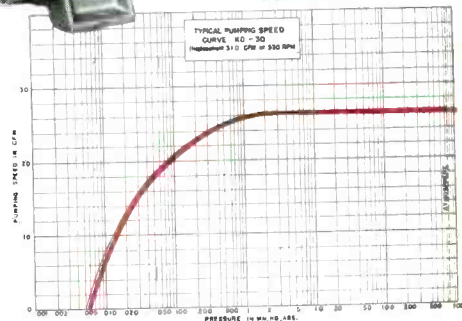
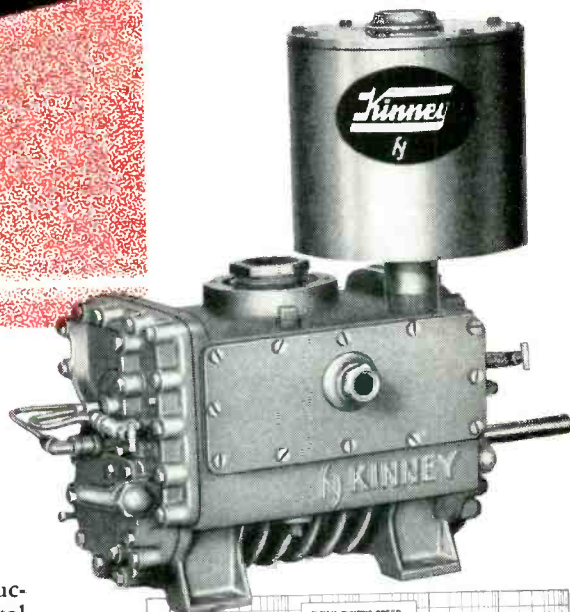

**SPECIFICATION DATA**  
Model KD-30 Single Stage-Duplex  
Design High Vacuum Pump

Ultimate Pressure (McLeod Gauge)	10 Microns
Free Air Displacement	30.4 CFM
Free Air Displacement	14.4 Liters/sec.
RPM	525
Motor H.P.	1 1/2
Motor RPM	1800
Oil Capacity	2 1/2 qts.
Cooling	Air
Shaft Diameter	3/4"
Inlet Connection	1 1/2" screwed
Outlet Connection	1 1/4" screwed
Valve Type	Poppet
Separator Tank	Kinney Swirl
Net Weight, Complete Unit	370 lbs.
Overall Dimensions, Complete Unit with Motor: Length — 28 3/4"; Width — 20 1/8"; Height — 19 7/8"	

**write  
today**

**KINNEY** MFG. DIVISION  
THE NEW YORK AIR BRAKE COMPANY   
3565 WASHINGTON STREET • BOSTON 30 • MASS.  
INTERNATIONAL SALES OFFICE, 90 WEST ST., NEW YORK 6, N. Y.

Name  Title   
 Company   
 Street   
 City  State

● Please send complete data describing the new Model KD-30 high vacuum pump.



## Money eases growing pains!

Many rapidly growing businesses come up against financial problems due to rapid expansion—a form of growing pains that hurts but doesn't have to be endured.

Money will cure them, provided the money is made available without surrendering a voice in management, diluting profits, or incurring new debt and carrying charges.

Our Working Money Plan completely meets the situation for manufacturers and wholesalers in certain fields of industry, if they are currently doing a business of \$1,000,000 or more a year.

We are presently helping hundreds of such companies. We supply the money that puts their sales on a cash basis . . . strengthens their cash position . . . permits the accumulation of big inventories in the slack season, so that production can be kept on an even keel . . . and eliminates clerical overhead and credit losses.

If your company has real growth and earning possibilities, our money could help you realize them profitably. Surely, the possibilities are worth talking over with one of our officers. No obligation, of course. Just drop us a note.

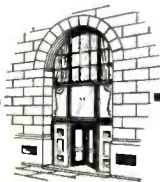

## Textile Banking Co., Inc.

*Providing operational financing for manufacturers and distributors of furniture, apparel, electronics, plastics and textiles.*

55 Madison Avenue, New York 10, N. Y.



Operator using contour projector can inspect tube element assemblies at rate of 150 per hour for precise positioning of electrodes in magnetron beam switching tubes for computers

Plainfield, N. J., a subsidiary of Burroughs Corp.

► **Technique**—A Kodak contour projector was selected as best suited for this job. Working at a pace which is more than able to keep up with top assembly speeds of 150 per hour, the operator merely lays the electrode assemblies in a predetermined position on the projector's work stage. The image produced by a beam of light passing over the elements is magnified and reflected onto the projector's screen in an exact tenfold magnification. With the metal parts shown in clear outline against the translucent mica, measurements down to 0.001 inch can be read quickly on the scribed chart of the contour projector.

For parts which are costly to make and are going into computers or control devices, 100-percent inspection is a paying proposition and is virtually a requisite to dependable production. In the beam switching tube, for example, the potting of the tubes in a permanent magnet is an extremely costly operation. Eliminating faulty units before they go through this expensive procedure more than pays

# AUTOMATIC

## silicon power rectifiers

MAXIMUM PERFORMANCE IN *Midget* SIZE

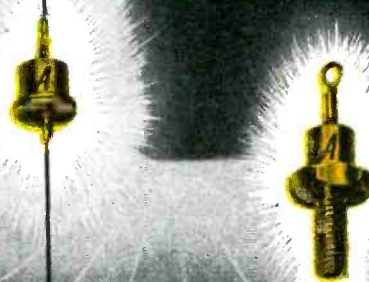

### TYPICAL VALUES AT 100°C

Type No.	P. I. V. (volts)	Average DC Output Current (MA)	Reverse Leakage At Rated P. I. V. ( $\mu$ A)	Mounting
1N440	100	300	0.03	Pigtail Leads
1N441	200	300	0.075	"
1N442	300	300	0.10	"
1N443	400	300	0.15	"
1N444	500	300	0.16	"
1N445	600	300	0.20	"
1N530	100	300	0.30	"
1N531	200	300	0.75	"
1N532	300	300	1.00	"
1N533	400	300	1.50	"
1N534	500	300	1.80	"

### TYPICAL VALUES AT 100°C

Type No.	P. I. V. (volts)	Average DC Output Current (MA)	Reverse Leakage At Rated P. I. V. ( $\mu$ A)	Mounting
1N535	600	300	2.00	Pigtail Leads
1N560	800	300	1.50	"
1N581	1,000	300	2.00	"
1N550	100	500	.45	Stud-Mount
1N551	200	500	.10	"
1N552	300	500	.15	"
1N553	400	500	.20	"
1N554	500	500	.25	"
1N555	600	500	.30	"
1N562	800	500	1.50	"
1N563	1,000	500	2.00	"

● Now, improve all your equipment designs . . . here from one complete source, both stud mount and pigtail rectifiers . . . designed for dependable operation at ambient temperatures in the range of  $-55^{\circ}\text{C}$  to  $+150^{\circ}\text{C}$ .

Twenty-two types are now available in quantity.

- These All-Welded units perform efficiently at all frequencies encountered in power applications — have negligible reverse currents — withstand severe atmospheric conditions — have excellent resistance to shock and vibration — display no aging characteristics over extended periods of time.
- Quality Automatic Silicon Rectifiers are particularly suited for magnetic amplifier and power supply applications which require superior forward conductance, low reverse leakage currents and exceptionally high efficiencies and rectification ratios. Their small size and light weight make them ideal for use in all types of miniaturized equipment.
- Write today for performance data sheets giving complete technical details.



MASS PRODUCERS OF  
ELECTRONIC COMPONENTS

DIVISION OF GENERAL INSTRUMENT CORPORATION  
65 GOUVERNEUR STREET NEWARK 4, N. J.

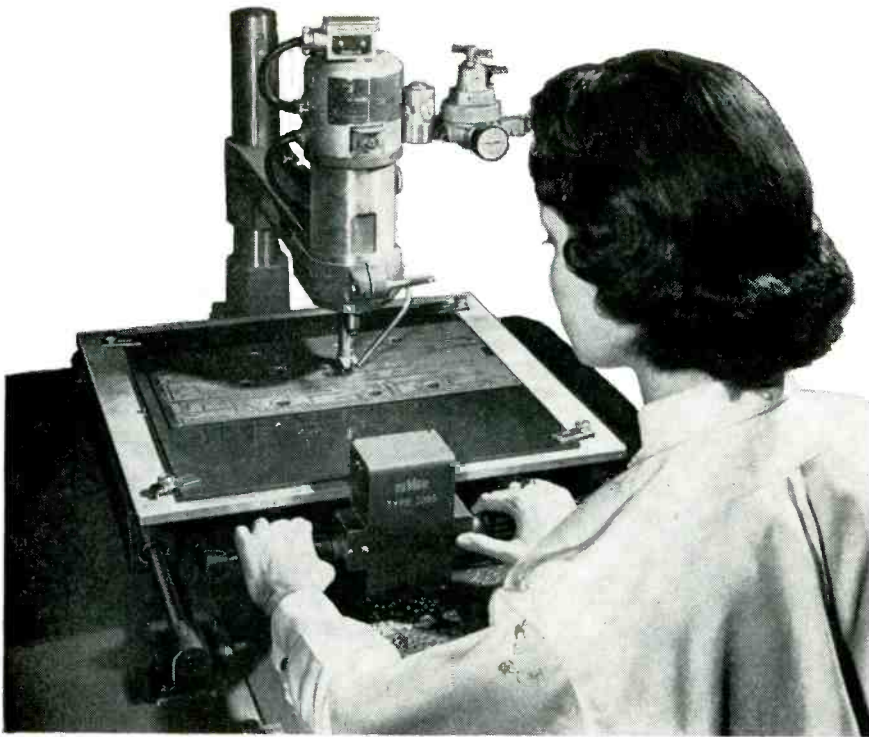

## PANTODRILL CUTS COSTS

*T*he answer to semi-high-speed production board drilling—at lowest possible cost . . .

The Du Mont Pantodrill requires no expensive tool or jig making. A simple template, made on a drill press, or the Pantodrill itself, serves as a guide to accurate drilling of up to thousands of production pieces.

The Pantodrill may be operated by unskilled personnel at a speed of up to 150 holes per minute with an accuracy of 0.010" center-to-center. The Pantodrill operates on a simple, foolproof principle which completely eliminates rejects due to misdrilling.

A pressure sensitive feed on the drill head automatically adjusts feed rate for all types of materials. Boards may be stacked up to 1" thickness so that a quantity may be drilled simultaneously.

The Pantodrill is the answer to economical pilot runs, or limited production runs.

*Send for complete details on the  
Pantodrill. It costs only*

# DU MONT®

## \$1995<sup>00</sup>

INDUSTRIAL ELECTRONICS—DEPT. EL  
760 BLOOMFIELD AVE.

ALLEN B. DU MONT LABORATORIES, INC., CLIFTON, NEW JERSEY

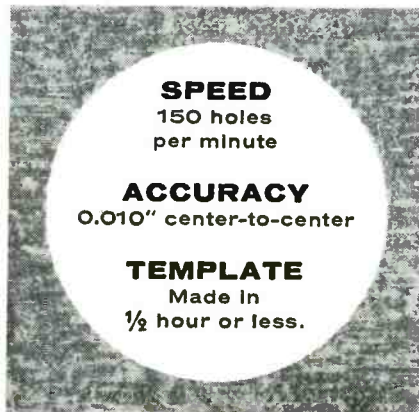

for the preliminary inspection costs.

► **Product**—Basically, the beam switching tube is a small high-vacuum unit with ten discrete positions, each of which is able to form, clear or switch an electron beam. Beams drawn from the cathode in the center of the tube are formed by the permanent magnet in which the tube is potted and can be located or switched to any of ten target positions. The end result is a device which can count up to 10 at any driven rate—in excess of 5 million times a second, if desired.

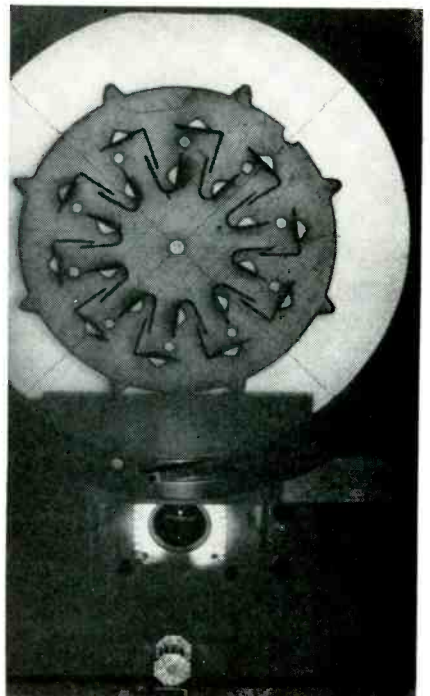

Electrode assembly is placed on anvil at lower center, in path of light beam that projects and magnifies to image size appearing on screen. Accuracy of electrode placement can then be easily checked

► **Vacuum Fixture**—Assembly devices had to be devised especially for mass production of the new tube. A vacuum-operated holding fixture aids in fitting 31 separate elements into mica holding wafers at top and bottom. The operator merely drops the various metal elements into a jig between the mica wafers, where they are held in position by vacuum, then completes the assembly by applying leverage. This lines up the 31 elements to within  $\pm 0.002$  inch of

# MODERN

testing methods  
insure reliability

## RMC DISCAPS

The proved reliability of RMC DISCAPS is a primary reason why their use is specified by leading manufacturers of electrical and electronic products. RMC insures this reliability with modern testing methods that provide a thorough check on power factor, capacity, leakage, and breakdown.

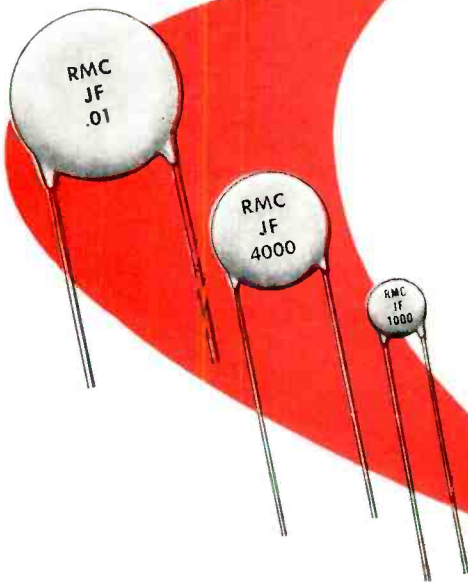
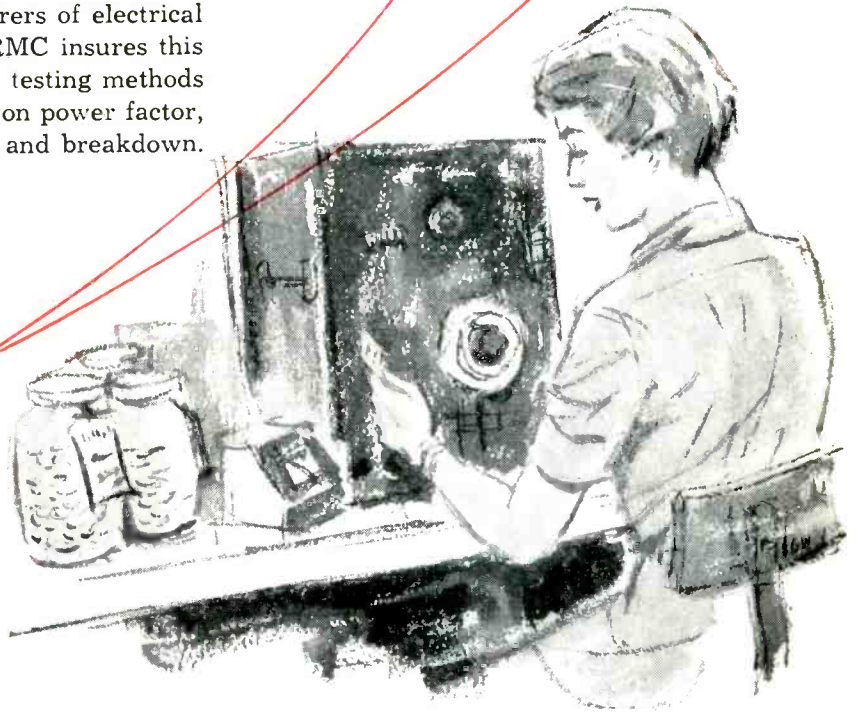

For a ceramic capacitor with superior frequency stability specify RMC's Type JF DISCAPS. They extend the capacity range of the RETMA Z5F type between  $+10^{\circ}$  and  $+85^{\circ}$  C and meet Y5S specs between  $-30^{\circ}$  and  $+85^{\circ}$  C.

If you use conventional or specialized capacitors investigate all the advantages offered by RMC. Write today on your company letterhead for complete information.

DISCAP  
CERAMIC  
CAPACITORS



**RADIO MATERIALS CORPORATION**  
GENERAL OFFICE: 3325 N. California Ave., Chicago 18, Ill.  
Two RMC Plants Devoted Exclusively to Ceramic Capacitors  
FACTORIES AT CHICAGO, ILL. AND ATTICA, IND.

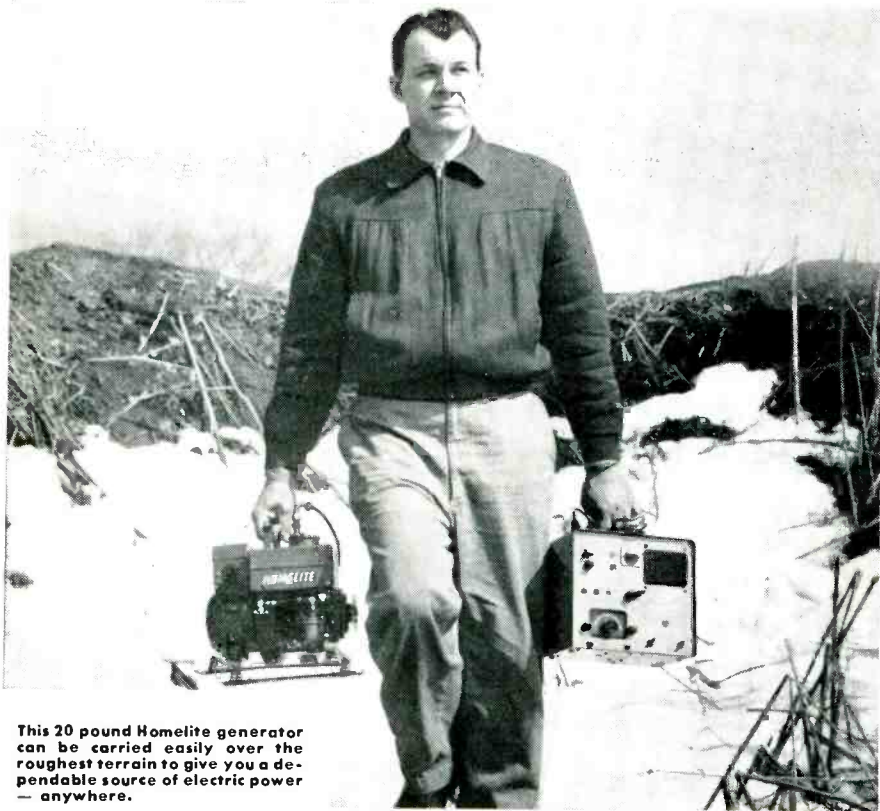

This 20 pound Homelite generator can be carried easily over the roughest terrain to give you a dependable source of electric power — anywhere.

## New 20 Pound Homelite Generator

Homelite's new 20 pound, 150 watt, gasoline-engine-driven generator can be carried — easily — anywhere to provide dependable electric power for your highly portable communications, surveying or prospecting equipment.

This unit is a commercial version of Homelite's highly successful "Midget" military model. It has a continuous-duty rating of 150 watts, 115 volt, 60 cycle, single phase alternating current. And, there's no need to carry a heavy fuel supply for this generator. One gallon of gasoline will operate this unit at full rated load for eleven hours.

Initial production is scheduled for January 1957. Write today for complete details.

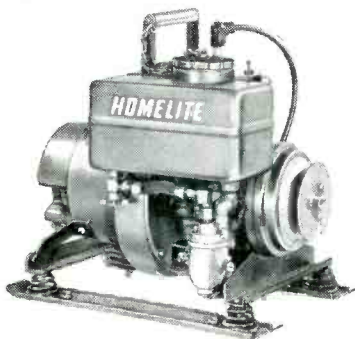

### MODEL 15A115

150 watts  
115 volt, 60 cycle  
single phase A.C.  
20 pounds

Manufacturers of  
Carryable Pumps,  
Generators, Blowers,  
Chain Saws

PERFORMANCE • DEPENDABILITY  
**HOMELITE**  
SERVICE

a division of Textron Inc.

6810 RIVERDALE AVENUE, PORT CHESTER, NEW YORK

Canadian Distributors:

Terry Machinery Co. • Toronto • Montreal • Vancouver • Ottawa • Edmonton • Moncton

quality control specifications.

Following assembly, imperfect units can be rejected with relatively small expense. If imperfect units were permitted to get into production, it would become increasingly difficult to find them and highly wasteful in that the cost of future production steps is much greater than that of the simple, high-speed optical inspection.

## Gelatin Mats Clean Shoes In Transistor Lab

TO REMOVE DUST particles from shoes of personnel entering the transistor research laboratory in Philco's Lansdale, Pa. laboratory, a large gelatin mat is placed on the floor in front of the door to this pressurized room. A second mat is inside the first airlock. The mats are cleaned at intervals of several hours by wiping with an alcohol-saturated cloth.

In combination with lint-free clothing for workers in the room, air conditioning and room pressurizing to keep airborne dust out, the gelatin mats insure the con-



Gelatin mat at entrance to White Room used for transistor research shows relative amounts of dust removed from men's and women's shoes



## A-MP's NEW PULSE PACKETTE

Cat. No. 855007 Specifically designed to trigger  
modulator thyratrons, type VC-1257 or equivalent.



This and similar designs now in production represent the culmination of A-MP years of experience in high reliability pulse components.

Cuts procurement, stocking, testing and assembly problems by  $\frac{2}{3}$ . Saves time, design work, size and weight. Offers better performance, greater reliability.

Special designs available to meet individual requirements. Similar standard designs available on the shelf for other thyatron trigger applications.

### Characteristics

1. Input: 2.8 KV DC MAX.  
at 100 ma DC MAX.
2. Output +1.7 KV pulse amplitude at 68 a peak into 25 ohm resistive load.
  - (a) Pulse width at 70% amplitude 2.2 microsec. MIN.
  - (b) Rise time between 20% and 85% amplitude .30 microsec. MAX.
  - (c) Allowable ripple on top wave +5%.
3. Pulses per second 0 min. 1000 max.
4. Operating ambient temperature range  $-55^{\circ}\text{C}$  to  $+71^{\circ}\text{C}$ .
5. Maximum operating altitude—10,000 ft.
6. Life expectancy 10,000 HRS.
7. Vibration and shock MIL-E-5400.

3-in-1 unit contains.

1. Resonant charging choke
2. Pulse Forming Network
3. Pulse Transformer

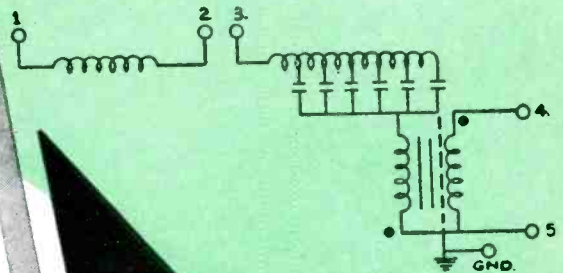

As a supplementary service A-MP can supply grid filter networks to match these Pulse Packettes.

**A-MP**

Aircraft-Marine  
Products, Inc.

Chemicals and Dielectric Division  
155 Park Street, Elizabethtown, Penna.

A-MP of Canada, Ltd  
1764 Avenue Road  
Toronto 12, Ontario, Canada

# new!... Continental Connectors

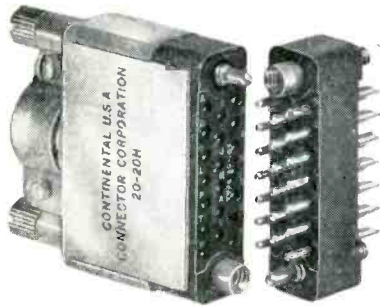

## Series '18' connectors with polarizing screwlocks\*

The new Series '18' provides a large, rugged contact with the same efficient spacing used on our Series '20'. The .053" diameter solder cups can accommodate two #20 AWG wires, if necessary. 20, 27 and 50 contact units are available.

Our reverse type guide pin and guide socket arrangement provides positive polarization. To insure against accidental disconnection you can order the Series '18' with the exclusive Continental Polarizing Screwlock.

Anodized aluminum hoods with top or side openings are available for positive cable support and strain relief.



### GUIDE PIN and GUIDE SOCKETS



### SERIES '18' SPECIFICATIONS

**CONTACTS:** 20, 27 and 50—plus other contacts and arrangements (9, 14, 34 will be available soon).

Contact pins (brass) and sockets (spring temper phosphor bronze) are silver and gold plated for low contact resistance.

**TERMINALS:** Solder cup or turret.

### ELECTRICAL RATINGS:

Voltage Breakdown	
At Sea Level	2100 Volts RMS
At 60,000 Ft.	750 Volts RMS
Current Rating	5 Amps

Additional information on these connectors, and special designs requiring the use of subminiature, printed circuit, hermetic seal, pressurized, high voltage, or power connectors are available on request. Write today for free catalog.

you're sure with



ELECTRONIC SALES DIVISION  
DeJUR-Amsco Corporation  
45-01 Northern Blvd.  
Long Island City 1, N. Y.

trolled environment needed for research on materials such as germanium and silicon that require precise control of impurities.

## Dip-Soldering VHF Television Tuner Wafers

USE OF A CONTOURED solder pot, having a curved indentation corresponding to the radius of the terminal line on a switch-type tuner wafer, gives greatly improved reliability of soldered joints at Radio Condenser Co.'s Camden, N. J., plant. The wafer itself is



Work setup for inserting coils in tuner wafer

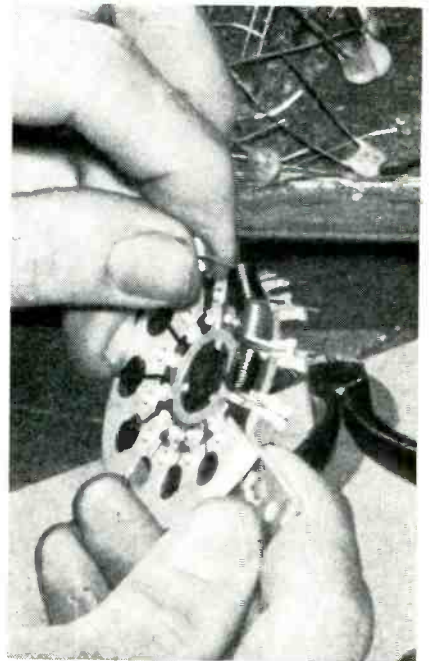

Closeup of coil-inserting operation. Six additional coils are produced in one operation of punch press, converting silver-plated copper sector of switch into six single-turn coils of different diameters

HUGHES PRODUCTS

presents 3 unusual new

# STORAGE TUBES

## MEMOTRON

The MEMOTRON, a direct-display cathode ray storage tube, retains traces and transients until intentionally erased. Analysis and comparison are possible without photography because MEMOTRON visually displays successive transient writings. All displays occur at uniform brightness, regardless of writing speeds, so are easily photographed for file records. Applications: viewing transients in shock testing, read-out of solutions from analog computers, curve plotting at high and low speeds, electrocardiography, vectorcardiography and heart sounds.

### General Specifications:

RESOLUTION... 50 to 60 written lines per inch.  
WRITING SPEED... 0 to at least 100,000 inches/second.  
BRIGHTNESS... 50 foot-lamberts.  
USABLE SCREEN DIAMETER... 4 inches.  
DIMENSIONS...  
Over-all length: 18 1/2 inches ± 1/2 inch.  
Bulb diameter: 5 5/8 inches maximum.  
Neck diameter: 2 1/4 inches ± 3/32 inch.



Photos show single transient pulses, 20 microseconds wide with a one microsecond rise time, showing writing capabilities of one million inches per second. These photos were taken in full daylight without a hood.

## TONOTRON

The TONOTRON, another exclusive Hughes direct-display cathode ray storage tube with a 5-inch screen, presents a complete spectrum of grey shades. The high light output makes a hood unnecessary, even when viewing in full daylight. TONOTRON's length of persistence and rate of decay are controllable. Superior presentation of the grey scale assures "high fidelity" picture reproduction. Applications: radar, Narrow Band Television, instrumentation, etc.



Photos: Left, weather radar with brilliant halftone picture on TONOTRON. Right, TONOTRON freezes action picture until intentionally erased.

## TYPOTRON

The TYPOTRON is the first commercially available storage tube for displaying printed data rapidly. A choice of 63 characters is available for the presentation of data in words, numbers or symbols. As a high-speed digital read-out device, the TYPOTRON writes characters 1/8 inch in size at speeds of at least 25,000 characters per second. The written information remains visible indefinitely without fading or blooming, until intentionally erased. This feature makes TYPOTRON an ideal read-out device in many digital computer applications.



Photo: Presentation of all available characters.

**HUGHES PRODUCT**

A DIVISION OF THE HUGHES AIRCRAFT COMPANY

ELECTRON TUBES 

Our applications engineers invite your inquiries regarding specific uses of these tubes. For further information and descriptive literature please write to:

HUGHES PRODUCTS • ELECTRON TUBES  
International Airport Station  
Los Angeles 45, California

# HOLD IT!

## You can etch Soldered Circuits FASTER in HUNT S.C.E.

(Solder Circuit Etch)

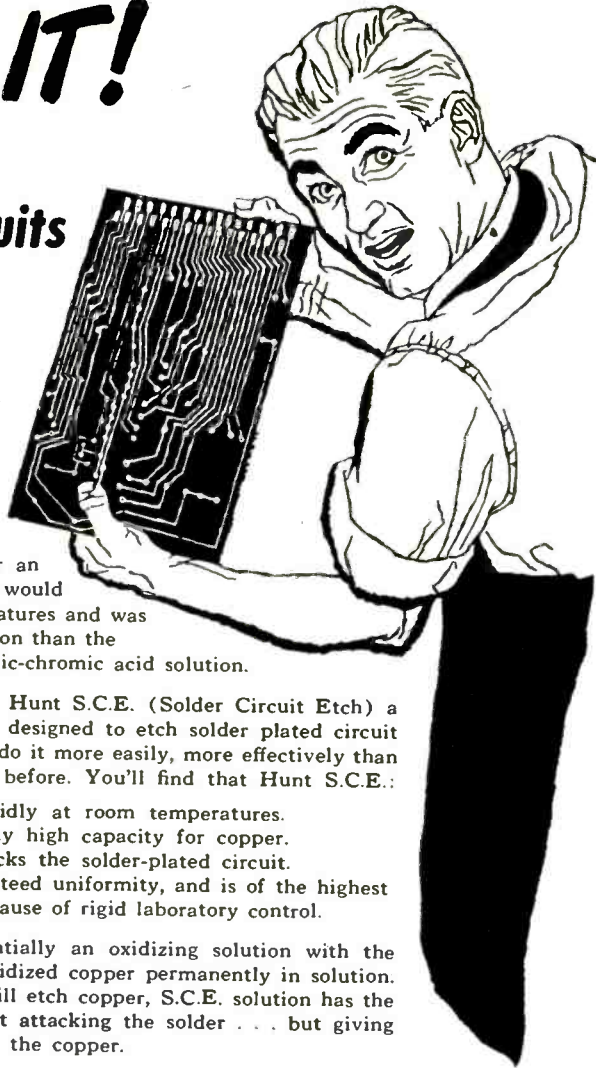

Hunt saw the need for an etchant that was faster, would work at normal temperatures and was more reliable in its action than the commonly used sulphuric-chromic acid solution.

Hunt now offers you Hunt S.C.E. (Solder Circuit Etch) a ready-prepared product designed to etch solder plated circuit boards . . . designed to do it more easily, more effectively than it has ever been done before. You'll find that Hunt S.C.E.:

1. Etches rapidly at room temperatures.
2. Has a fairly high capacity for copper.
3. Never attacks the solder-plated circuit.
4. Has guaranteed uniformity, and is of the highest quality because of rigid laboratory control.

Hunt S.C.E. is essentially an oxidizing solution with the capacity to keep the oxidized copper permanently in solution. Although many acids will etch copper, S.C.E. solution has the peculiar property of not attacking the solder . . . but giving fast, odorless etching of the copper.

### HUNT R.C.E. (RAPID CIRCUIT ETCH) FOR PRINTED CIRCUITS

Hunt R.C.E. is a proprietary etchant, formulated to etch printed circuits fast and to speed up production.

It offers these 6 big advantages:

1. 15% increase in etching speed.
2. Immediate action over entire circuit.
3. Uniformly smooth etching.
4. Easily removed by washing.
5. Substantial increase in capacity.
6. Freedom from fumes.

A temperature between 100°F and 120°F is recommended as optimum etching temperature. With splash etching and 110°F temperature, a printed circuit board should etch in 2½ minutes in fresh R.C.E. solution.

Both etchants are described in Technical Bulletins No's 1 & 3 available from your nearest Hunt branch or Palisades Park, N. J.



Hunt S.C.E.  
solution is  
supplied  
in 125 lb.  
carboys;  
Hunt  
R.C.E.  
solution  
in 145 lb.  
rubber drums.

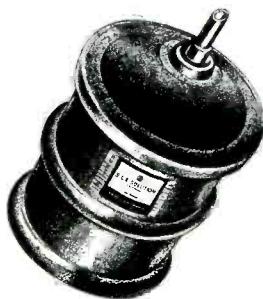

**PHILIP A. HUNT COMPANY**  
PALISADES PARK, N. J.

Chicago • Cleveland • Cambridge • Brooklyn • Atlanta • Dallas • Los Angeles • San Francisco



Holding wafer assembly over curved indentation in rim of special solder pot, in readiness for dip-soldering of terminals

stamped in such a way that only the five terminals are immersed in the solder.

In preparation for soldering, an operator inserts five coils in the holes of the terminal lugs, with two leads going in each lug so that the coils are in series. Each coil is insulated with a different color of self-stripping insulation, so that the operator can select coils by color rather than by counting or measuring turns. Immersion in solder volatilizes the insulation, eliminating need for stripping the coil leads and giving freshly exposed copper for optimum soldering.

The operator carefully lowers the terminals into the solder pot at the location of the indent. An asbestos collar around the pot provides a finger or hand rest.

### Thickness Gage for Blind

AN ULTRASENSITIVE electronic sound gage, developed by manufacturing engineers at the Detroit plant of Burroughs Corp., enables blind employees to quickly and ac-

# Transitron

## SILICON DIODES

### HIGH CONDUCTANCE

### HIGH FREQUENCY

RATINGS AT 150° C			
Type	Maximum Average Forward Current ma	Continuous Inverse Operating Voltage Volts D.C.	Minimum Saturation Voltage Volts
IN484B	50	130	150
IN486A	50	225	250
IN488A	50	380	420
IN457	25	60	70
IN458	25	120	135
IN459	25	180	180

SPECIFICATIONS AT 125° C			
Type	Forward Current At + 1 V ma	Inverse Current At Specified Voltage ua at Volts	Maximum Operating Voltage Volts D.C.
IN252	10	10 @ - 5	20
IN251	5	10 @ - 10	30
S9G	2	10 @ - 20	40

Typical Shunt Capacitance: 0.8 uufd  
 Typical Pulse Recovery time: 0.15 usec  
 Operating Frequency Range: 0-1000 mc

Write for Bulletin TE-1350

THE PROVEN PERFORMANCE of Transitron's

silicon rectifiers and diodes has led to their widespread use in critical high temperature applications. The large number of types available allows optimum design for any given circuit.

For low level power supply or magnetic amplifier service, the subminiature diodes or miniature rectifiers are recommended. For higher power requirements, the stud-mounted rectifiers provide up to 30 KW.

## SILICON RECTIFIERS

### UP TO 35 AMPS AT 150° C

RATINGS AT 150° C			
	Maximum Average Forward Current Amps	Peak Recurrent Inverse Voltage Volts	RMS Inverse Voltage Volts
Miniature (Pig Tail Leads)			
TJ10A	0.2	100	70
TJ20A	0.2	200	140
TJ40A	0.2	400	280
Military Types			
IN253*	1.0	100	70
IN254*	0.4	200	140
IN255*	0.4	400	280
IN256*	0.2	600	420
Medium Power Types			
IN249A	20	100	70
IN250A	20	200	140
TR352	20	350	250
High Power Types			
IN412A	35	100	70
IN413A	35	200	140
TH352	35	350	250

\* JAN types Rated at 135° C

Write for Bulletin TE-1351

# Transitron

electronic corporation • melrose 76, massachusetts



Germanium Diodes

Transistors

Silicon Diodes

Silicon Rectifiers

# Parabolic MICROWAVE ANTENNAS

for all bands 2000 mc - 4000 mc

7000 mc  
X and K

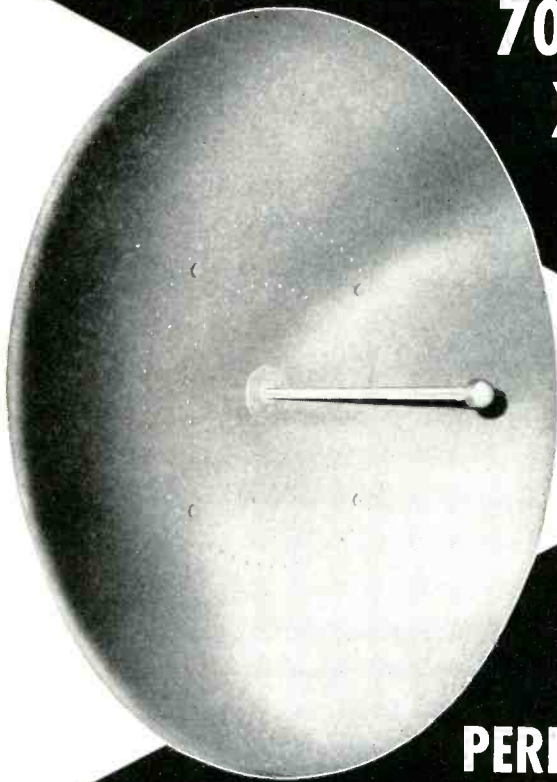

4000 mc antenna  
with Gabriel  
waveguide feed.

with these  
**PERFORMANCE  
ADVANTAGES**

- Low VSWR
- High gain
- Low side and back lobes
- Pressurized feeds
- All-weather dependability
- Ready adaptability to special service requirements

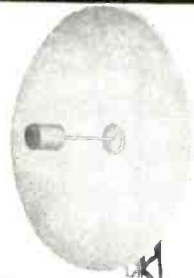

2000 mc antenna with dipole feed.

For every microwave application, Gabriel can furnish antenna equipment of proved efficiency and reliability. The experience and facilities of Gabriel Laboratories offer prompt, dependable solution of your antenna problems. And the manufacturing plant of Gabriel Electronics Division assures volume production to the Laboratories' performance specifications.

For analysis of your antenna or microwave problems, write us or telephone NEedham 3-0005 (through Boston).



**GABRIEL ELECTRONICS DIVISION**

THE GABRIEL COMPANY, Needham Heights 94, Massachusetts

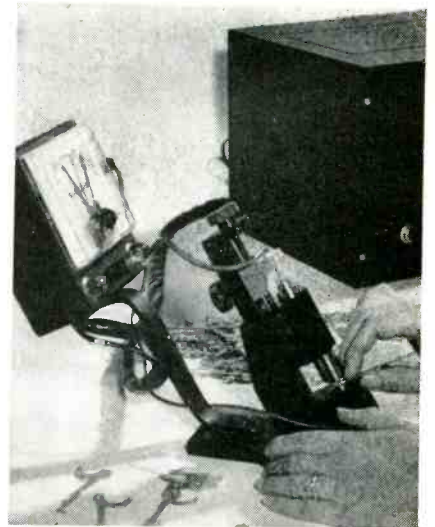

Gaging setup used by blind workers

curately check dimensions of precision parts for complex electronic components and equipment. Workers learn to operate the gage with approximately 5 minutes instruction.

Production parts are inserted into a measuring anvil that is connected by cable to an amplifier. A thickness reading is taken electronically. The reading is indicated on a meter dial to an accuracy of 0.0002 inch and at the same time is transformed into a sound tone as well as a visual light signal.

The blind operator, wearing a headphone similar to that of a hearing aid, hears a low-pitched tone for parts that are under the proper dimension and other readily recognized tones for parts that are within or above tolerance limits.

## Building Capacitors to Pass Pitch and Roll Test

GANG TUNING capacitors used in shipboard telemetering, Teletype and Telefax receivers are uniquely machined and assembled at Radio Condenser Co., Camden, N. J. to pass rigid pitch and roll tests without changing capacitance.

The chief requirement is an absolute minimum of play in the rotor bearings. The first of the final steps is eccentric precision honing of the bearing holes in the assembled frame. This is done on a honing machine made by Sunnen Products



# THE INSIDE STORY

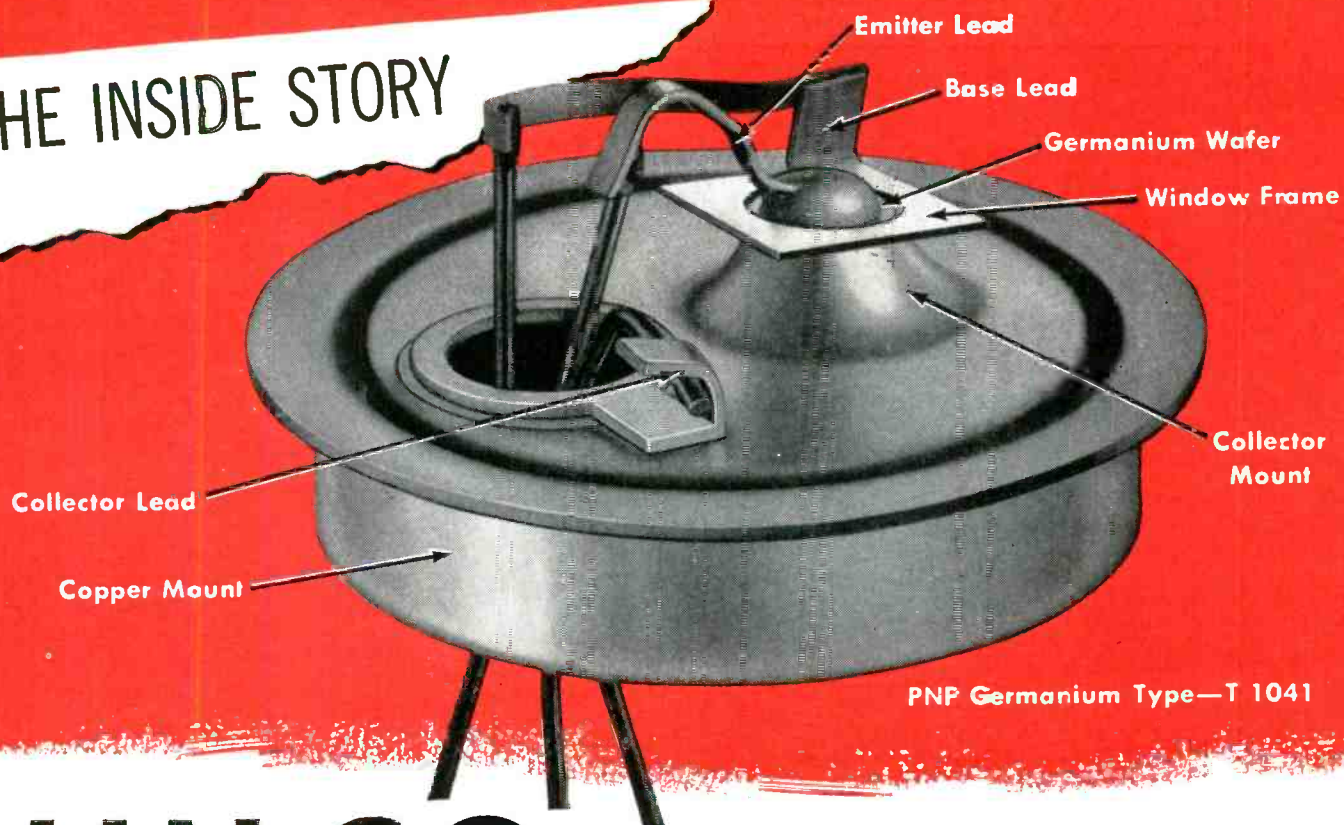

PNP Germanium Type—T 1041

# PHILCO® POWER TRANSISTOR

## THERMAL DROP $1\frac{1}{2}^{\circ}\text{C}$ PER WATT TYPICAL\*

The advanced design of Philco Power Transistors gives a new high in reliability. Superior thermal drop is achieved by placing the collector junction in intimate contact with the copper base—and the copper mount is assured maximum dissipator contact by "knee action" of the aluminum mounting clamp. The Philco exclusive cold weld gives freedom from contamination—for long

life! Long, flexible, insulated leads assure optimum electrical connection in printed circuitry—without disturbing the hermetic seal. Available in production quantities and specifically built for the audio output stage of auto radios, Philco Power Transistors are ideally suited to high power amplifiers, servo-amplifiers, power converters and low-speed switches.

### FEATURES

High beta at high currents •  $100^{\circ}\text{C}$  storage temperature\* Improved alpha cut-off • Absolute hermetic seal  
 Low surface leakage currents • Superior thermal drop • Low distortion • Low saturation resistance

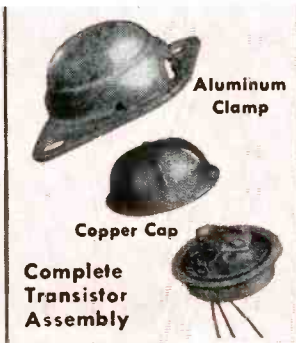
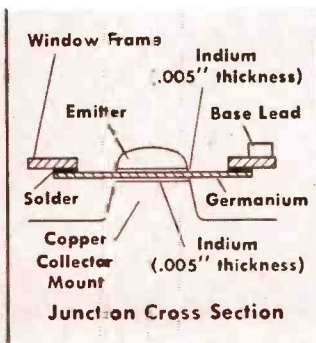

### Specifications

Power Gain (5W—Class A)	35 db (typical)
D. C. Current Gain ( $I_c = -1a, V_c = -1.5V$ )	40—120
Sat. Voltage ( $I_c = 1a$ )	0.8V Max.
<b>Maximum Ratings</b>	
Collector Dissip. @ $75^{\circ}\text{C}$ Ambient	10W.
Collector Voltage	40V.

Make Philco your prime source of information for Power Transistor applications.  
 Write to Dept. E, Lansdale Tube Company, Lansdale, Pa.

**PHILCO CORPORATION**  
 LANSDALE TUBE COMPANY DIVISION  
 LANSDALE, PENNSYLVANIA

**Signals can get crossed-up here**



**...but your relays have to be right every time in this league!**



Elgin's New NEOMITE . . . the world's smallest, weighs only .09 ounces . . . yet resists vibration up to 500 cps. at 10 G over a  $-55^{\circ}\text{C}$  to  $+85^{\circ}\text{C}$  temperature range and has a contact rating of 28 v DC at 250 ma. Resistive Load. Write today for complete specifications.



Extreme reliability and highest quality—these are two necessary requirements in today's relays, whether they are used in air traffic control systems or in guided missiles. Even the smallest percentage of failure among the hundreds of relays employed in such highly complex automatic devices renders costly equipment unusable. Backed by Elgin's universally recognized reputation for extreme precision in craftsmanship and manufacture, Elgin Relays give you the dependability your product must have. That's why they're specified by major manufacturers everywhere. Shouldn't you contact Elgin . . . now?

**ELECTRONICS DIVISION**  
**ELGIN NATIONAL WATCH COMPANY**  
 Elgin, Illinois

Sales Representatives in Principal Cities of U. S. and Canada



Honing two bearing holes simultaneously in capacitor frame. Angular alignment of holes must be maintained within 15 seconds and diameter within 0.0002 inch

Co., St. Louis, Mo., which has two oil stones spline-loaded on an eccentric shaft. The operator holds the capacitor frame in his hands and pushes it slowly onto the honing shaft while a spray of oil is directed on the work. This step gives a hole

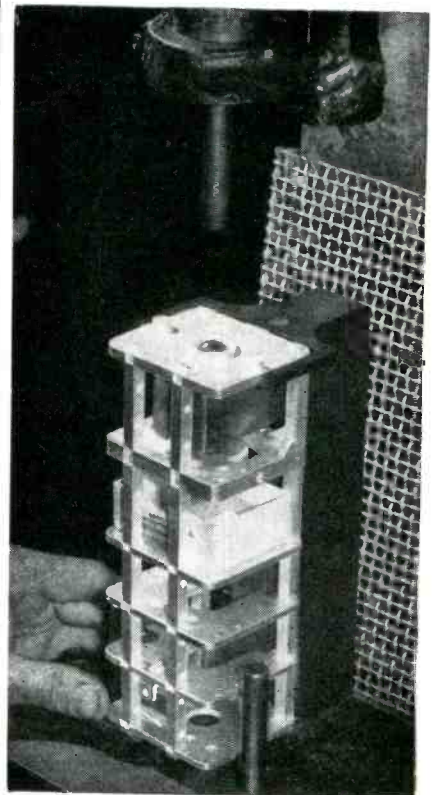

Using arbor press to push precision steel sizing ball through upper bearing hole and then through next lower bearing hole. Rubber blocks prevent ball from dropping



# ENGINEERS...

## LOOK



## TEN YEARS AHEAD!

Will your income  
and location allow  
you to live in a  
home like this...  
spend your leisure  
time like this?



*A Douglas engineer lives here*

*They can...if you start your career  
now at Douglas!*

Take that ten year ahead look. There's a fine career opportunity in the engineering field you like best waiting for you at Douglas.

And what about the Douglas Aircraft Company? It's the biggest, most successful, most stable unit in one of the fastest growing industries in the world. It has giant military contracts involving some of the most exciting projects ever conceived... yet its commercial business is greater than that of any other aviation company.

The Douglas Company's size and variety mean that you'll be in the work you like best — side by side with the men who have engineered the finest aircraft and missiles on the American scene today. And you'll have every prospect that ten years from now you'll be where you want to be career-wise, money-wise and location-wise.

For further information about opportunities with Douglas in Santa Monica, El Segundo and Long Beach, California divisions and Tulsa, Oklahoma, write today to:

**DOUGLAS AIRCRAFT COMPANY, INC.**  
C. C. LaVene, 3000 Ocean Park Blvd., Santa Monica, California



### ANALOG COMPUTING

Those with degrees in mathematics, physics and engineering are needed to solve interesting problems on direct analog computers and differential analyzers.

Knowledge of or experience in dynamics, stress analysis, servo-mechanisms, heat flow and circuit analysis or non-linear mechanics is helpful.

When network discharge service needs

**HIGH**

**RESISTANCE**

**to SHOCK and VIBRATION—**

Specify  
THE NEW  
**Kuthe**  
**3C45W**



Product of  
the world's  
largest  
manufacturer of  
**HYDROGEN  
THYRATRON**

**Ruggedized, smaller size—for more dependable performance in missiles, aircraft, vehicles and other heavy-duty applications . . .**

Kuthe's new 3C45W is a unipotential cathode, 3-element hydrogen-filled thyratron designed for network discharge service . . . producing pulse outputs of 50 KW at an average power level of approximately 65 watts.

Smaller in size and featuring ruggedized construction to a remark-

able degree, the 3C45W is outstandingly reliable under the most severe conditions of shock and vibration. It is equipped with a reservoir for longer, more stable life.

Kuthe's new 3C45W incorporates the broadest engineering experience, highest quality and finest craftsmanship in the industry.

**Principal Electrical-Mechanical Data and Ratings:**

Heater voltage	6.3 ± 5.0%	Average anode current	45 ma.
Heater current	2.6 amps.	Grid drive voltage	175 v. (min.)
Minimum heating time	3 min.	rad	0.6 us.
Mounting position	Any	Δ rad	0.15 us.
Overall length	3.75" (max.)	tj	0.02 us.
Greatest diameter	1.56" (max.)	Pb	0.3 x 10 <sup>9</sup>
Base	Med., 4-pin, A4-9		* 25 us. after end of pulse.
Anode connector	Small metal, C1-1	<b>Typical operation as Pulse Modulator, DC Resonance Charging</b>	
Reservoir	Connected internally across cathode heater	Anode supply voltage	1.5 KV DC
Anode supply voltage	800 v. (min.)	Pulse repetition rate	2500 PPS
Peak anode voltage, forward	3000 v. (max.)	Pulse duration	0.5 microseconds
Peak anode voltage, inverse	3000 v. (max.)*	Pulse forming network impedance	50 ohms
Peak anode current	35 amps. (max.)	Trigger voltage	200 volts
Anode current rate of rise	750 amps./usec. (max.)	Peak power output	45 KW
		Average power output	56 watts
		Anode current	40 ma. DC

**For complete information, write to Dept. W-213**

***Kuthe Laboratories, Inc.***

An Associate of

INTERNATIONAL TELEPHONE AND TELEGRAPH CORPORATION  
730 South 13th Street • Newark, N. J. • Blgelow 2-6000



Matching bearings to bearing holes within 0.0002 inch with comparison air gage operating at 34 lb air pressure

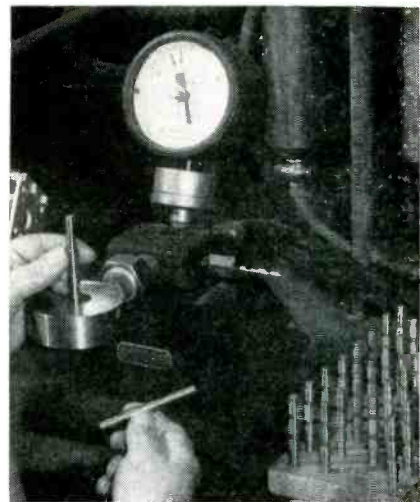

Matching inside diameter of rear bearing, on shaft projecting to right from gage, to within plus 0.0001 inch and minus 0.0000 inch with extension of rotor shaft that operator is lowering into other gage head with left hand

diameter within 0.0002 inch of the specified 0.2500-inch hole.

After honing, the capacitor frame is placed in a holding fixture mounted on an air-actuated arbor press and a precision steel ball is pushed through each bearing hole in turn. Rubber blocks are placed under each of the two bearings to catch the ball as it comes through when the hydraulic ram of the press is operated. The ball is driven through an undersize hole in the first rubber block and is caught by the second block. The press used for this purpose is made by Green-erd Arbor Press Co., Nashua, N. H.

The capacitor frame goes to the

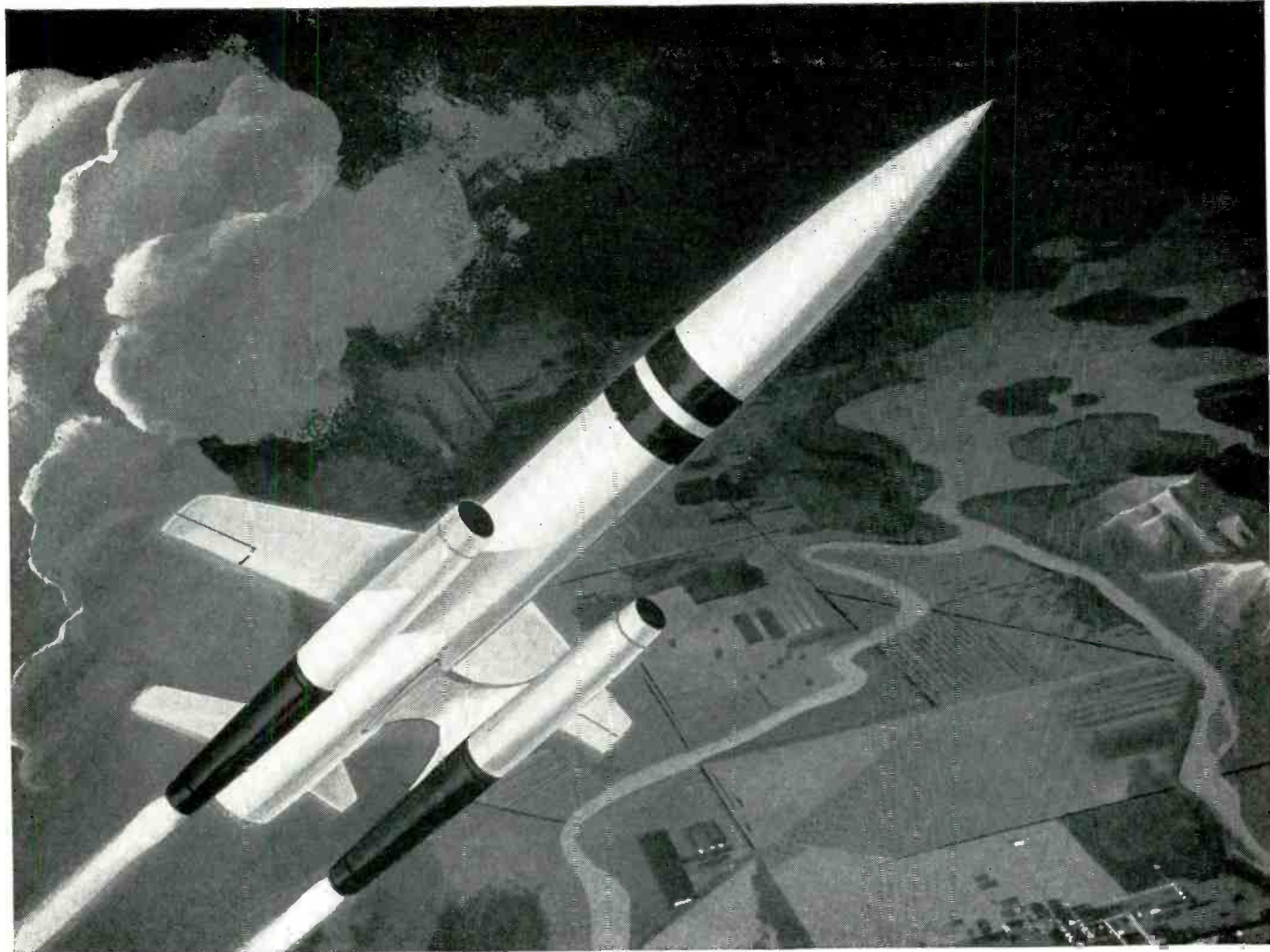

## Dow high temperature magnesium alloys have excellent fabrication characteristics

Lightweight structural metals with high strength, stiffness and elasticity at elevated temperatures! A new group of Dow magnesium alloys offers a great combination of these properties without the fabricating difficulties normally experienced with other high temperature materials.

Specially developed for use in airframes, missile and engine structures, the new alloys are already making weight reductions possible for several manufacturers. These alloys show advantages at temperatures up to 700°F. Limited test data on properties up to 800°F. are available for some of them.

**FABRICATION:** Fabrication characteristics are equal to those of standard magnesium alloys.

**WELDABILITY:** 95 to 100% weld efficiency at elevated temperatures.

**FORMABILITY:** Single deep draws can be easily accomplished.

**MACHINABILITY:** Best machining characteristics of any structural metal.

One of the new alloys is magnesium-thorium composition HK31A. It is now available in rolled form from stock. Castings and sheet in mill quantities are also readily available. A companion alloy for extruded shapes and forgings will soon be in production.

For more information about the new high temperature magnesium alloys, contact your nearest Dow Sales Office or write

to THE DOW CHEMICAL COMPANY, Magnesium Sales Department MA 362KK, Midland, Michigan.

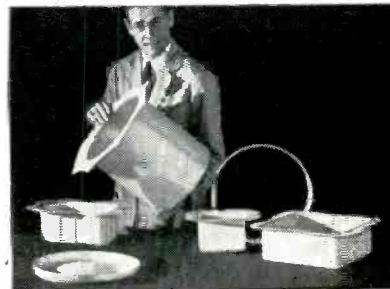

**EASILY FORMED.** These HK31A parts were drawn using production dies and processes for standard magnesium alloys. The parts retained a higher percentage of original properties than standard alloys.

*you can depend on DOW MAGNESIUM*



# LAB PULSESCOPE

by

# Waterman



MODEL S-5-C

Size:  
13" x 16 1/2" x 14 1/8"

National Electronics Conference . . . Booth #70

## ANOTHER EXAMPLE OF *Waterman* PIONEERING . . .

The LAB PULSESCOPE, model S-5-C, is a JANized (Gov't Model No. USM/24C) compact, wide band laboratory oscilloscope for the study of all attributes of complex waveforms. The video amplifier response is up to 11 MC and provides an equivalent pulse rise time of 0.035 microseconds. Its 0.1 volt p to p/inch sensitivity and 0.55 microsecond fixed delay assure portrayal of the leading edge when the sweep is triggered by the displayed signal. An adjustable precision calibration voltage is incorporated. The sweep may be operated in either triggered or repetitive modes from 1.2 to 120,000 microseconds. Optional sweep expansion of 10 to 1 and built-in markers of 0.2, 1, 10, 100, and 500 microseconds, which are automatically synchronized with the sweep, extend time interpretations to a new dimension. Either polarity of the internally generated trigger voltage is available for synchronizing any associated test apparatus. Operation from 50 to 400 cps at 115 volts widens the field application of the unit. These and countless additional features of the LAB PULSESCOPE make it a MUST for every electronic laboratory.

## WATERMAN PRODUCTS CO., INC.

PHILADELPHIA 25, PA.  
CABLE ADDRESS: POKESCOPE

### MANUFACTURERS OF

- PANELSCOPE\*
- S-4-C FAR PULSESCOPE\*
- S-5-C LAB PULSESCOPE\*
- S-11-A INDUSTRIAL POKESCOPE\*
- S-12-B JANIZED RAKSCOPE\*
- S-12-C SYSTEMS RAKSCOPE\*
- S-14-A HIGH GAIN POKESCOPE\*
- S-14-B WIDE BAND POKESCOPE\*
- S-14-C COMPUTER POKESCOPE\*
- S-15-A TWIN TUBE POKESCOPE\*
- RAYONIC® Cathode Ray Tubes and Other Associated Equipment

\*T. M. REG.

MEMO...  
Write for details today!



WATERMAN PRODUCTS

assembly position, where it is placed over one shaft of an air-operated comparison gage made by Moore Products Co., Philadelphia. The diameter of the first bearing hole in the frame is gaged and compared with the diameter of a bearing that the operator places over the other sensing head. Up to a dozen or more different bearings



Tilting finished capacitor unit parallel to rotor shaft at 45 degrees on pitch and roll test set, to check oscillator section for radial and axial play in bearings.

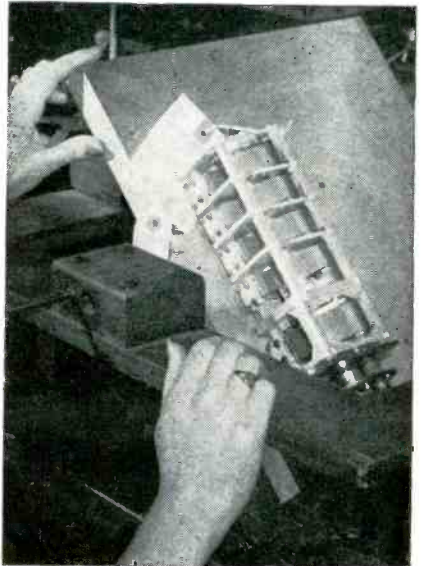

Tilting capacitor at 45 degrees in other plane to check for radial and end play in bearings within 0.00035 inch. Operator listens to beat note to detect changes in capacitance during test

may be tried until one is found that matches the hole in the frame within the specified tolerance limits. For an exact match the gage reads zero.

The same process is repeated for the other bearing hole. If no bearing provides the required match, the nearest oversize bearing is

# NO MORE SEARCHING FOR GLASS-SEALING ALLOYS

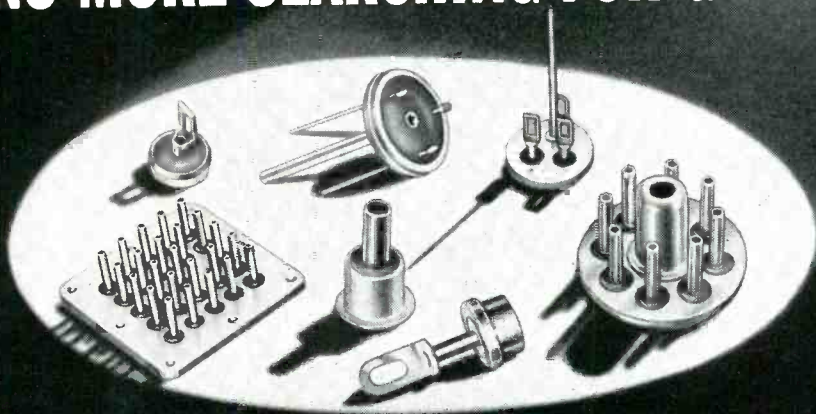

Photos of parts using glass-sealing alloys, courtesy Electrical Industries, Newark, N.J.

## Superior Tube offers widest selection

EASY-TO-USE SELECTION CHART FOR GLASS-SEALING ALLOYS				
Kind of glass used	Superior Tube alloys to be specified	Condensed Physical Properties		
		Thermal Exp. Coeff.	Density	Temper
Corning Glass Nos. 704, 706, 708, 708AJ	# 42	5.3	0.29	All alloys available in Tempers 1, 2 and 3
Corning Glass Nos. 001, 012, G12	# 52	9.5	0.298	
Corning Glass Nos. 001, 012, 8160	# 4 (Sylvania)	8.5	0.292	
Corning Glass Nos., External 008, 001, 012, 024, 8160	445	10.5	0.273	
Theoretically any glass. Use with feathered edge seal.	OFHC Copper	16.5	0.323	
Corning Glass Nos., Internal 1990, 1991; External, any soft glass	MT-1010	12.5	0.283	

Best place to look first for the glass sealing alloys you need is Superior Tube Company. Wide selection available for virtually all application requirements. Quantities as small as 50 ft. in any size and analysis. Superior Tube Glass Sealing alloys are cold drawn to close tolerances in Seamless or Weldrawn\* form. Sizes from .012 in. to 5/8 in. OD, with walls ranging from .0015 in. to .083 in. maximum. Supplied in random and coiled lengths—8 in. diameter coils up to .075 in. OD, 18 in. diameter coils for larger sizes. 90% of coils are 30 ft. minimum, 10% are 10 ft. minimum. In addition to the standard alloys listed in table, many special alloys are available on special order.

\*T.M. Reg. U.S. Pat. Off., Superior Tube Co.



SUPERIOR TUBE CO.  
2500 GERMANTOWN AVE., NORRISTOWN, PA.

Please send detailed information on Glass Sealing Alloys.

Name .....

Company .....

Street .....

City ..... Zone ..... State .....

# Superior Tube

The big name in small tubing  
NORRISTOWN, PA.

Johnson & Hoffman Mfg. Corp., Mineola, N.Y.—  
an affiliated company making precision metal stampings and deep-drawn parts

# WHY SPARK GAP TUBES ARE IMPORTANT—

and how Bendix Red Bank can help  
you with spark gap problems!



Bendix Red Bank "Spark Gap" Tubes are specially designed to do two big jobs in electronic circuits.

First, to act as a "triggering" switch—as on jet ignition systems. Here, Bendix\* Spark Gaps pass high currents with relatively low voltage drop and have the advantage of being able to handle high voltages in small space. Further, these tubes can be made insensitive to ambient temperature variations and are not normally affected by pressure, altitude, or humidity changes.

The second function of Bendix Spark Gaps is as a *protective element*—guarding radar equipment against voltage overload, to name one example. Here, Bendix Spark Gaps keep high voltage surges from getting through to damage circuit components.

Our design and manufacturing experience with spark gap tubes is extremely broad. If our extensive line of these tubes . . . ranging from 750V to 50KV in DC breakdown voltages . . . does not already contain a type to fit your needs, we are in a position to design one to handle the job with the exact degree of efficiency that you require.

To find out more about what we can do to help you with your spark gap problems, get in touch with RED BANK DIVISION, BENDIX AVIATION CORPORATION, EATONTOWN, NEW JERSEY.

\* TRADEMARK

West Coast Sales and Service:  
117 E. Providencia Ave., Burbank, Calif.  
Export Sales and Service:  
Bendix International Division,  
205 East 42nd St., New York 17, N. Y.  
Canadian Affiliate:  
Aviation Electric, Ltd., P. O. Box 6102,  
Montreal, Quebec.



sanded down with 600-grit abrasive cloth until a match is obtained.

On another Moore comparison gage, the two selected bearings are placed on one of the gaging heads and rotor shafts are tried one after another in the other head until a shaft is found that matches the bearings within tolerance limits.

After completing assembly of the tuning capacitor, it is mounted on the table of a pitch and roll test set and the oscillator section is connected to a frequency meter. The operator then tilts the capacitor in two different planes to simulate pitching and rolling of a ship, while listening with earphones connected to give a beat frequency that changes in tone when the capacitance changes.

## In-Line Exhaust for Power Magnetrons

A MOVABLE-TROLLEY in-line exhaust system makes it possible to exhaust and seal 180 large magnetrons per week in Raytheon's Waltham, Mass. plant. The processing is achieved with greater speed and efficiency than was possible on stationary exhaust stands or even rotary units.

The 200-foot-long exhaust line

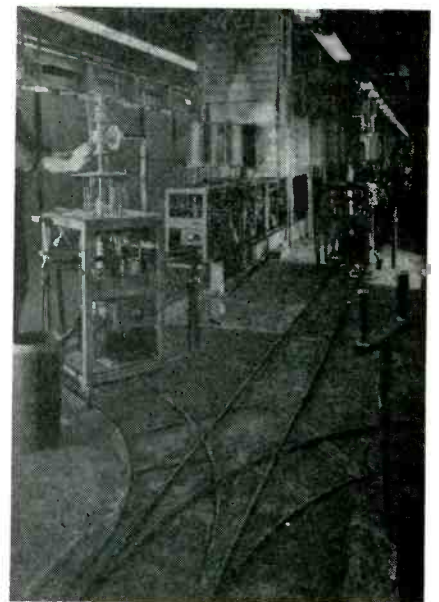

Mounting magnetron on car at start of in-line exhaust system, for trip through bake-out oven in background. Empty cars return to starting point on center track

**AMPLIFY with STABILITY**  
**MICROVOLTS**

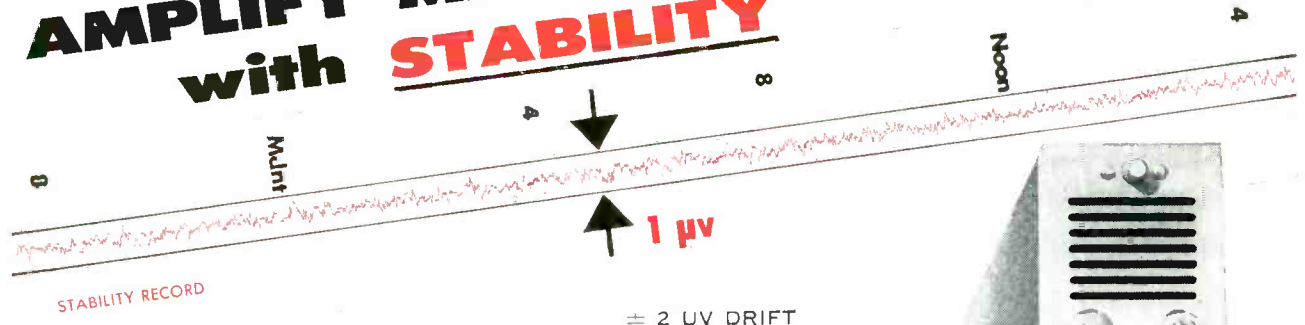

- INTEGRAL POWER SUPPLY
- HIGH OUTPUT LEVEL
- EXTREMELY LOW NOISE
- BROAD BANDWIDTH
- 10 ACCURATE GAIN RANGES
- HIGH INPUT IMPEDANCE

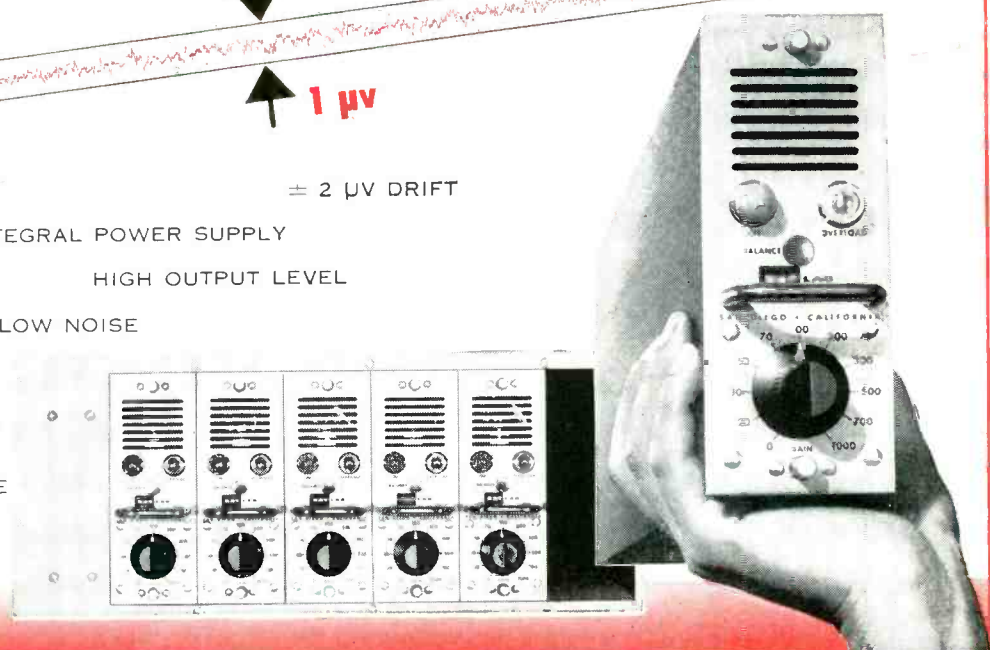

The KAY LAB Model 111 amplifier provides maximum stability and the lowest drift of any commercially available broadband d-c amplifier. It is the end result of years of research in the field of chopper stabilized broadband d-c amplifiers. Thousands of KAY LAB amplifiers are in daily use. The Model 111 incorporates KAY LAB's proven chopper amplifier circuitry and provides ten extremely precise, feedback controlled gain ranges. Several feedback loops assure high accuracy, stability and uniform frequency response. The completely new and unique circuit provides rapid recovery from severe overloading and unsurpassed dynamic performance — unaffected by load or gain changes. The Model 111 is available in a single-unit cabinet or in a six-unit rack-mountable module. The amplifiers are extremely compact, the six-unit module occupies only a 19-inch rack width. APPLICATIONS: The Model 111 is ideal for permanent low level d-c instrumentation, telemetering, or as a strain gage amplifier, transducer amplifier, scope preamplifier, recorder driver amplifier, or general purpose laboratory amplifier.

**SPECIFICATIONS**

Gain . . . . .	0, 20, 30, 50, 70, 100, 200, 300, 500, 700, 1000	Power Requirements:	
Gain Accuracy . . . . .	± 1% DC to 2 KC	Amplifier . . . . .	117 V — 60 cycles — 70 VA
Input Impedance . . . . .	100,000 Ω	Cabinet . . . . .	117 V — 60 cycles — 15 VA
Output Capability at DC . . . . .	0 to ± 35 V where $R_L > 1000 \Omega$	6 Unit Rack Adaptor . . . . .	117 V — 60 cycles — 45 VA
Output Impedance . . . . .	0 to ± 40 MA where $R_L$ is 10 to 400 Ω	Dimensions: Amplifier Unit . . . . .	2 7/8" wide, 7 7/8" high, 14 3/4" deep
Equivalent Input Drift . . . . .	± 2 μv with regulated line	Rack Adaptor for 6 Units . . . . .	19" wide, 8 3/4" high, 18 1/4" deep
Equivalent Input Noise . . . . .	0 to 3 cps, less than 5 μv peak to peak	Net Weight — Amplifier . . . . .	11 pounds
Chopper Intermodulation . . . . .	Less than 0.1%	PRICE: Amplifier Unit . . . . .	\$550.00
Linearity . . . . .	Better than 0.1% to 2 KC	19-inch Rack Adaptor for 6 amplifier (with fans and connectors)	200.00
Frequency Response . . . . .	± 3% (0.3 db) DC to 10 KC, less than 3 db down at 40 KC	Cabinet for single amplifier (with fan and connector)	is available.

*... the Standard in chopper-stabilized instruments*



# the sky is our world

From advanced research into the fundamental forces of the universe—gravity, nucleonics, astrophysics—to the launching of man's first stepping stones into space itself, Martin engineering activities are among the most exciting in the aircraft industry today.

The sky is our world, and outer space is the next frontier!

*If you are interested in learning the story of a great engineering adventure, which includes some of the most advanced projects now in the research and development stage, contact J. M. Hollyday, Dept. E-10, The Martin Company, Baltimore 3, Maryland.*

**MARTIN**  
BALTIMORE

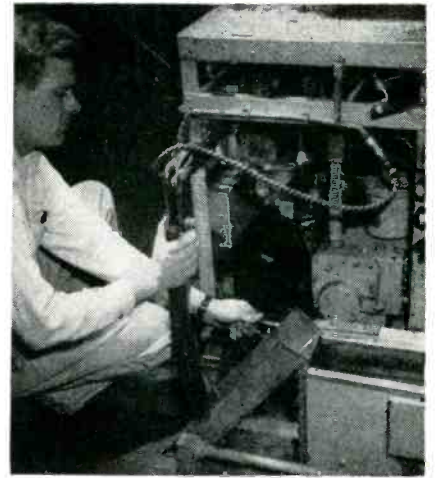

Guiding power take-off shoe into energized track which parallels entire length of line. Cooling water for pumps is drawn from trough on far side of line and discharged into trough in foreground here. Spring contacts at upper right corner of car pick up power for cathode out-gassing

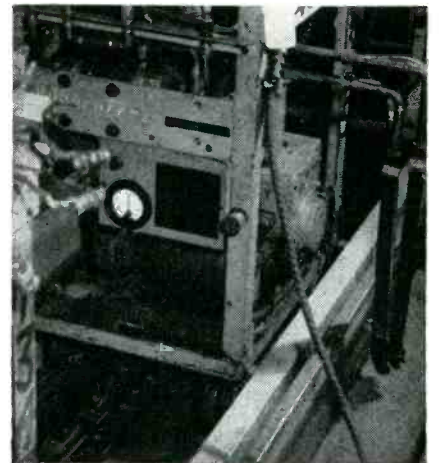

Cooling water for pumps is picked up by hoses dipping into water trough. Chain conveyor that moves trolley cars can be seen here between wheels

has reduced labor requirements from 528 to 192 man-hours per 24-hour day and has reduced tube rejects by 20 percent.

► **Steps in Processing**—Each tube is mounted on its own car, which is moved through the successive steps of processing by a motor-driven conveyor chain that is indexed to move the cars one step ahead at predetermined time intervals. Each car contains a mechanical pump for rough exhaust and an oil-diffusion pump for achieving the final vacuum. Each car is also fitted with connections to supply all the electric power, water, air





When you specify Cornell-Dubilier capacitors, you can be sure that nothing is left to chance. Production procedures, test and inspection operations and quality control are in full compliance with Cornell-Dubilier high-quality standards and *your* specifications. Quality and Reliability are talents we have cultivated since 1910. That's why you can count on the consistently dependable facilities of C-D's 16 plants!

**Typical C-D paper tubulars:**

**TIGER CUB\***: Cardboard-cased paper tubular with Polykane<sup>(1)</sup> end-fill. Vikane-impregnated for excellent capacitance stability. High moisture resistance. Operating temperature range: -55°C to +100°C.

**TINY CHIEF\***: Small, all-purpose paper tubular, molded in extra-hard thermosetting plastic for long-lasting all-around satisfaction. Available with high temperature wax impreg-

nant for operating temperature range -40°C to +90°C and Vikane or Polykane\* impregnant for -55°C to +100°C operation.

**ROYAL CUB\***: Cardboard-cased paper tubular with Polykane\* end-fill. Tough, durable, withstands rough handling, vibration, shock, soldering iron heat. Operating temperature range: -55°C to +100°C.

**BUDROC\***: Steatite-cased paper tubular. Polykane\* end-fill for extra protection against heat and humidity. High temperature wax impregnant for operating temp. range -40°C to +90°C and Vikane impregnant for -55°C to +100°C.

<sup>(1)</sup> Polykane: A development of the C-D laboratories. A solid thermosetting compound will not crack, soften or flow.

*Write for catalog to Cornell-Dubilier Electric Corporation, South Plainfield, New Jersey.*



CONSISTENT HI-DEPENDABILITY  
**CORNELL-DUBILIER CAPACITORS**

\* ®



SOUTH PLAINFIELD, N. J.; NEW BEDFORD, WORCESTER & CAMBRIDGE, MASS.; PROVIDENCE & HOPE VALLEY, R. I.; INDIANAPOLIS, IND.; SANFORD, FUQUAY SPRINGS & VARINA, N. C.; VENICE, CALIF.; & SUB.: THE RADIART CORP., CLEVELAND, OHIO; CORNELL-DUBILIER ELECTRIC INTERNATIONAL, N. Y.

# Lightweight! SERVO Magnetic Amplifiers

The servo amplifiers illustrated are typical standard types. Other models, including higher power types, are available for systems engineering. The complete MA line offers the designer a choice of compact, low cost types, amplifiers featuring fast response at high gain and all-magnetic models providing highest performance.

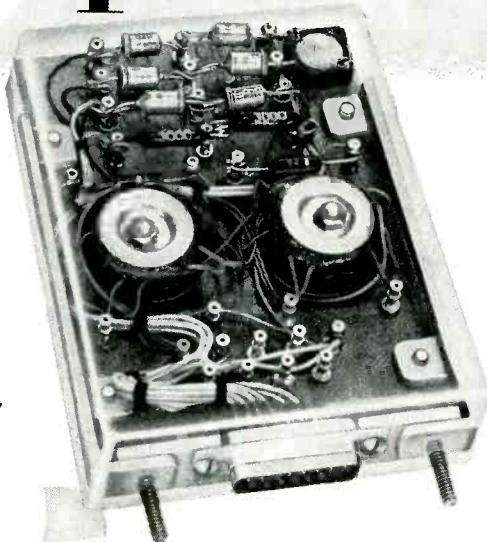

In addition to standard types, custom designs can be produced for special applications, or complete servo and automatic control systems can be engineered to your requirements.

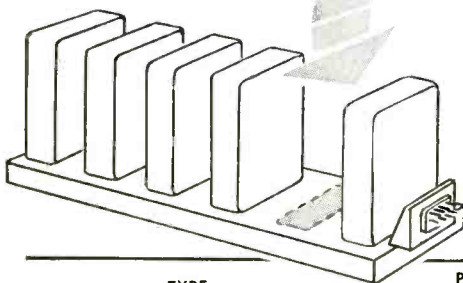

TYPE	SUPPLY	POWER OUTPUT	SENSI-TIVITY	RESPONSE TIME-SEC.
LIGHTWEIGHT SUB-MINIATURE MAGNETIC AMPLIFIER	115 volts 400 cps.	½, 3, 5, 10 watts	.02 volts	.003
MAGNETIC PRE-AMP + SATURABLE TRANSFORMERS	115 volts 400 cps.	3, 5, 6, 10, 18 watts	1 volt AC	.03
MAGNETIC PRE-AMP + HIGH GAIN MAGNETIC AMPLIFIER	115 volts 400 cps.	5, 10, 15, 20 watts	0.1 volt AC	.008 to .1
TRANSI-MAG*: TRANSISTOR + HIGH GAIN MAGNETIC AMPLIFIER	115 volts 400 or 60 cps.	2, 5, 10, 15, 20 watts	.08 volt AC into 10,000 ohms	.01

Call or write for new illustrated bulletins.

**Magnetic Amplifiers • Inc**  
632 TINTON AVE., NEW YORK 55, N. Y. — CYPRESS 2-6610  
West Coast Division  
136 WASHINGTON ST., EL SEGUNDO, CALIF. — EASTGATE 2-2056



and gas required during processing.

The processing steps, in order, are bake-out, cathode out-gassing, high-power pulsed operation and seal-off. Vacuum is achieved before the tube enters the bake-out oven and is maintained throughout the run. After seal-off, the tube is removed from the car for addition of permanent magnets and final test. The car is returned by conveyor to the starting point.

Cylindrical hoods are placed over

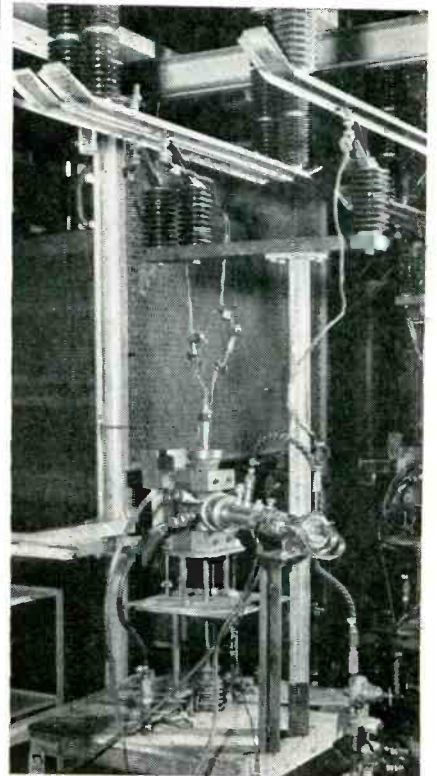

After cathode out-gassing, three leads are attached to magnetron as shown, in preparation for high-power operation

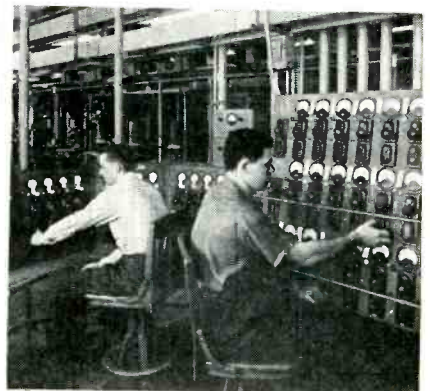

High-voltage console. Operator at left adjusts voltage on each tube as it comes into position, while operator at right adjusts current, to give individual and continuous monitoring of power on all tubes from central point

# Reliability



Isolated microwave relay installations must be reliable and require the extra performance factors of mechanical and electrical design found only in ANDREW Parabolic Antennas. Thousands of installations serving over a million channel miles of microwave have proven their superiority.

ANDREW offers a complete range of sizes and frequencies. Specify ANDREW Antennas for your microwave system. Here is a representative selection of stock antennas.

#### TYPE NUMBERS OF STOCK PARABOLIC ANTENNAS

Frequency Range (MC)	ANDREW Type Number			
	4 ft. dia.	6 ft. dia.	8 ft. dia.	10 ft. dia.
890 - 920	1004A-1	1006A-1		1010A-1
920 - 960	1004A-2	1006A-2		1010A-2
1700 - 1850	2004A-1	2006A-1	2008A-1	2010A-1
1850 - 1990	2004A-2	2006A-2	2008A-3	2010A-3
1990 - 2110	2004A-3	2006A-3	2008A-3	2010A-3
2450 - 2700		P6-24		P10-24
3750 - 4200			PS8-37	
5925 - 6425	P4-59	P6-59	P8-59	P10-59
6575 - 7125	P4-65	P6-65	P8-65	P10-65
7125 - 7425	P4-71	P6-71	P8-71	P10-71

#### TYPE P4-71

Freq. Range	7125-7425 MC
Max. VSWR	1.10
Min. Gain Over Isotropic	36.8 db
Side Lobe Level	-24.0 db
Input Connection	UG-345A/U Pressurized (Max. 15 PSI)

Specifications of these and other stock antennas and special design antennas are available by consulting the ANDREW Sales Engineer in your area or by writing to:

**Andrew**  
CORPORATION  
363 EAST 75th STREET • CHICAGO 19

Offices: New York • Boston • Los Angeles • Toronto

ANTENNAS • ANTENNA SYSTEMS • TRANSMISSION LINES

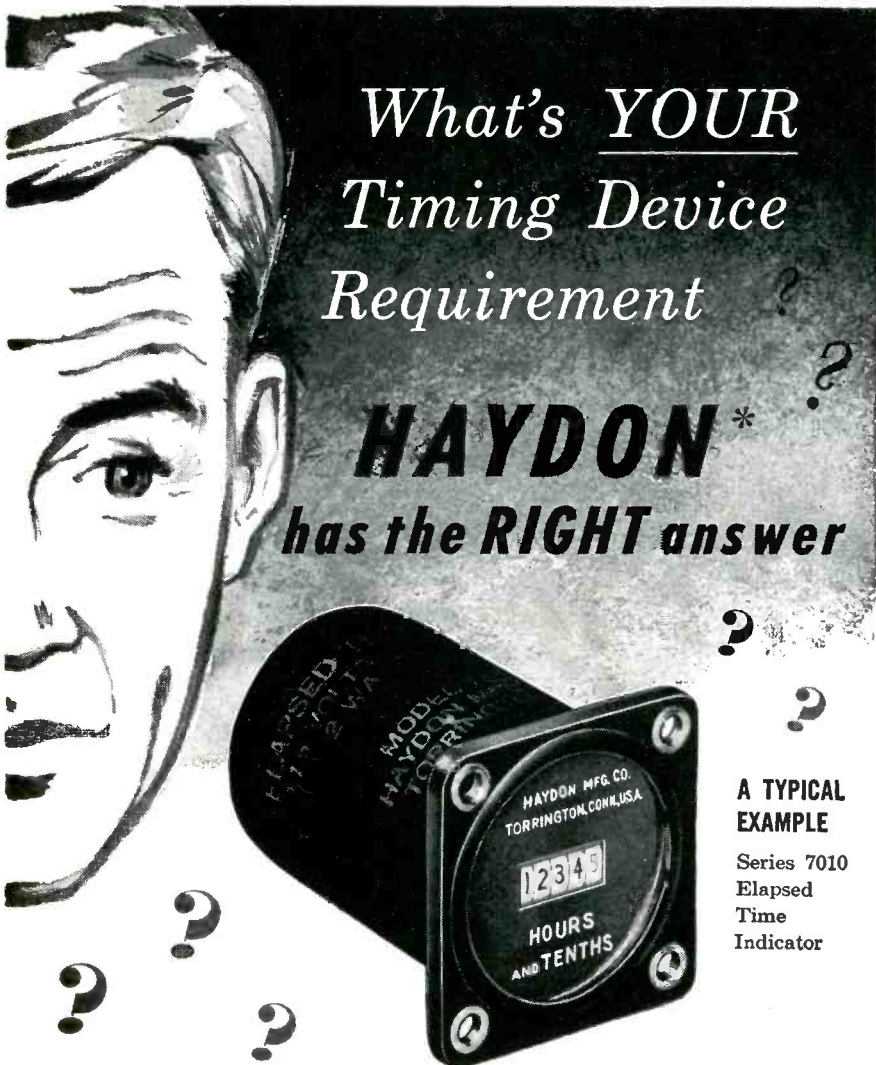

What's YOUR  
Timing Device  
Requirement ?

**HAYDON\*** ?  
has the **RIGHT** answer ?

**A TYPICAL  
EXAMPLE**

Series 7010  
Elapsed  
Time  
Indicator

**THE RIGHT MOTOR . . .** *unusually compact, fully enclosed mechanism, controlled lubrication, simple, accurate and dependable, operates in any position.*

**THE RIGHT DESIGN . . .** *for any application because you can select from the full line of HAYDON STANDARD interval timers, time delay relays, cycle timers, and elapsed time indicators.*

**THE RIGHT FACILITIES . . .** *because HAYDON has the fully integrated engineering and manufacturing facilities to produce and deliver quality on time . . . economically . . . in large or small lots.*

**THE RIGHT SALES SERVICE . . .** *because the HAYDON Field Engineer in your area is a Timing Specialist fully qualified to counsel you. He's listed in your Yellow Pages. Have him come in to discuss your requirements . . . or, if you prefer, write to us direct.*

\*Trademark Reg. U.S. Patent Office

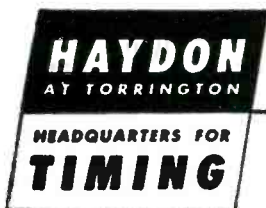

A Subsidiary of General Time Corp.

**HAYDON Manufacturing Company, Inc.**  
2434 ELM STREET, TORRINGTON, CONN.

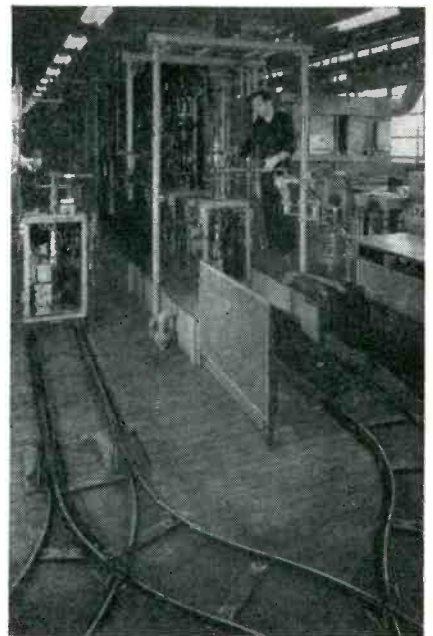

End of line. Completed magnetron is here sealed off, removed from car and prepared for final testing and packaging. Empty cars are switched to other track and returned to starting point

the tubes during their passage through the bakeout oven and a flow of reducing gas is maintained inside the hoods to prevent oxidation.

After cathode out-gassing, the temporary cathode leads are removed and the tube is prepared for high-power operation by attaching cathode, heater and neutral leads that come down from overhead high-voltage terminals. Pole pieces and a water load are also attached at this time.

The water load is water-cooled in the same manner as the vacuum pumps and is also air-cooled by a hose connected to a single compressor that serves all cars in the high-power section. As each new car enters this section, the supply hose is shifted to it from the car ahead and the two cars are linked together with a short hose.

Some high-power magnetrons required 24 hours at bake-out and exhaust time on the former single stationary exhaust unit that required the full attention of one operator. When it became necessary to expand production facilities, it was decided that even the largest rotary exhaust unit for these tubes would not produce the high-power magnetrons at a rate high enough to meet service requirements.

# SUPRAMICA® ceramoplastics

... THE WORLD'S MOST NEARLY PERFECT INSULATION

The research and production skill of MYCALEX CORPORATION OF AMERICA has for many years given design engineers the ultimate in versatile electrical insulation materials... MYCALEX®, the original glass-bonded mica... SYNTHAMICA,

the first commercially produced synthetic mica... and a completely new ceramoplastic — SUPRAMICA\* — for applications that demand the ideal combination of physical, thermal and electrical characteristics.

## SUPRAMICA® 555 is moldable!

This superior ceramoplastic insulation features... operation at temperatures up to 950°F... complete dimensional stability... moldable to precision tolerances... positive bonding to metal inserts... low electrical loss... very high

arc resistance... carbonization... resistance to moisture, oil and organic solvents... permanent radiation resistance... high dielectric strength... thermal expansion coefficient same as steel.

### TYPICAL APPLICATIONS

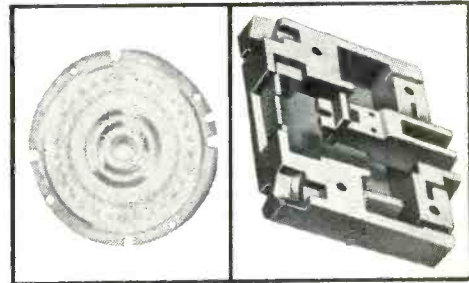

## SUPRAMICA® 500 is machineable!

This superior ceramoplastic insulation features... operation at temperatures as high as 1000°F... machineable to precision tolerances... absolute dimensional stability... high dielectric strength... low electrical loss... very

high arc resistance... no carbonization... thermal expansion matching steel... water-, organic solvent-, and oil-proof performance... permanent radiation resistance... good mechanical strength.

### TYPICAL APPLICATIONS

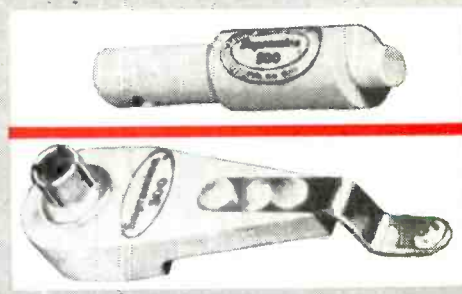

## Other Famous MYCALEX Products... for Special applications

### MYCALEX 410®

Standard quality moldable glass-bonded mica insulation.

### MYCALEX 410X®

Lightweight moldable glass-bonded mica insulation.

### MYCALEX 400®

Standard quality machineable glass-bonded mica insulation.

### MYCALEX® K and KM

Capacitor dielectrics.

### TELEMETERING EQUIPMENT and COMPONENTS

Mycalex TM55 series commutation switches and SUPRAMICA 555 ceramoplastic commutator plates... perfect for low-voltage, low-noise-level switching... write to Department 111 for full technical information.

**MYCALEX  
CUSTOM-  
MOLDING  
AND  
CUSTOM-  
MACHINING  
SERVICES**

... unexcelled facilities are ready to fill all your insulation requirements... short runs or mass production to meet the most stringent tolerances and delivery schedules... write to Department 112 for full details.

# MYCALEX CORPORATION OF AMERICA

General Offices and Plant: Clifton Boulevard, Clifton, New Jersey

Executive Offices: 30 Rockefeller Plaza, New York 20, New York

Sales Offices: Chicago, Los Angeles, Dayton, Washington



\*MYCALEX and SUPRAMICA are registered trade-marks of MYCALEX CORPORATION OF AMERICA for glass-bonded mica and ceramoplastics respectively.

World's largest manufacturer of glass-bonded mica and ceramoplastic products

# New Products

Edited by WILLIAM P. O'BRIEN

67 New Products and 66 Manufacturers' Bulletins Are Reviewed  
... Control, Testing and Measuring Equipment Described and  
Illustrated ... Recent Tubes and Components Are Covered

## CONTROL

is smaller than a dime

CLAROSTAT MFG. Co., INC., Dover, N. H. Series 44 miniaturized control is meeting the space limitations of transistorized assemblies such as hearing aids, pocket radios, portable radios, tv sets, portable test equipment and printed circuits.

► Specifications — The control

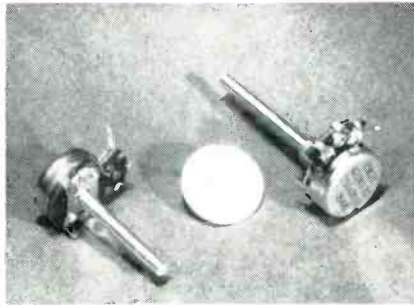

measures only  $\frac{3}{16}$  in. in diameter by  $\frac{1}{8}$  in. deep. It is rated at 0.2 w at 40 C. It is available in resistance ranges of: linear, 200 ohms to 5 megohms; tapered, 1,500 ohms to 2.5 megohms. Resistance tolerances are:  $\pm 20$  percent; above 100,000 ohms,  $\pm 30$  percent. Both bushing and tab mounting designs are available. The spst or dpst switches are available with 0.5 ampere, 25 v d-c rating. Circle P1 inside back cover.

## DIGITAL RECORDER

automatically-sequenced

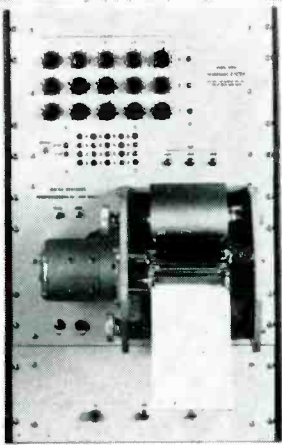

POTTER INSTRUMENT Co., INC., 155 Cutter Mill Road, Great Neck, N. Y., has announced an automatically-sequenced high-speed digital recorder. Model 3151 provides a simple and economical means for simultaneous recording "on" or "off" voltage phenomena appearing on as many as 45 channels at sampling rates as high as 2,500 per sec. Typical applications include monitoring of operations and data in large-scale digital computers and other data-processing systems.

Records are made in the form of black marks for on channels and no marks for off channels on electrosensitive Teledeltos recording paper. Recording paper speed is in excess of 150 ips, providing approximately  $\frac{1}{8}$  in. spacing for the 2.5-kc sampling rate. Standard 4-in. wide paper rolls contain 400 ft of recording paper, providing more than 3,500,000 record locations on a single roll.

Because of the extremely high speed paper drive mechanism, a 3-sequence digital interval generator is used to program paper drive functions. Circle P2 inside back cover.

## SPECIAL PURPOSE RECEIVER

for f-m and a-m reception

NEMS-CLARKE, INC., 919 Jesup-Blair Drive, Silver Spring, Md., has added to its line of special purpose and telemetry receivers, the type 1502. It operates in the frequency range of 55 to 260 mc.

Use of a type 416-B planar triode in the first r-f stage assures that the noise figure does not exceed 6 db at any frequency. Features



include a 5-position variable bandwidth control, squelch and i-f gain control. Circle P3 inside back cover.

## ROTARY JOINT

for X-band use

LITTON INDUSTRIES, 5873 Rodeo Road, Los Angeles 16, Calif. Model H250T/S61 rotary joint is a broad

**CHATHAM ELECTRONICS  
AT WORK**

# "Measure of the 4th Dimension"

**Manufacturers  
of Components  
and Equipment  
of Outstanding  
Dependability**



Breaking today's research time barrier... the solving of problems to be encountered tomorrow... these are the achievements of Chatham since its inception. Major design advances—the tangible results of this continuous research—are reflected in every unit in the broad list of components and equipments currently supplied to Industry, Science and the Armed Forces. The end result is a new conception of dependability and functional efficiency... directly measurable in terms of feature-by-feature product superiority. Write for product data and information today, on Chatham manufacturing and research capabilities.

**Chatham Electronics**  
DIVISION OF GERA CORPORATION

Livingston, New Jersey — Branch Offices in Principal Cities

DESIGNERS AND MANUFACTURERS OF ELECTRONIC TUBES, SELENIUM  
RECTIFIERS, AIRCRAFT CONVERSION EQUIPMENT AND CUSTOM COMPONENTS

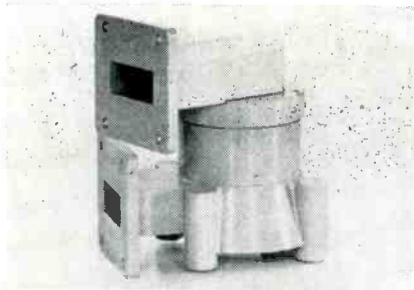

band, high power waveguide coupler designed especially for opera-

tion under severe shock and vibration conditions.

Capable of operating at 600 kw peak power for short intervals, the rotary joint will operate at 350 kw during extended use. Impact and vibration tests per MIL-T-17113 show unimpaired mechanical operation and no internal damage.

Preloaded ball bearings provide maximum mechanical reliability and minimum change of electrical

characteristics during rotation. Vswr is less than 1.10 over a frequency band of 8,400-9,600 mc. Change of vswr with rotation is less than 0.2 db.

Waveguide and mounting flanges are readily supplied to customer specifications as an integral part of the rotary joint, eliminating blind soldered seams and other potential breakdown points. **Circle P4 inside back cover.**

## PRECISION RESISTORS

can be custom designed

EASTERN PRECISION RESISTOR CORP., 675 Barbey St., Brooklyn 7, N. Y. New techniques enable the company to encapsulate a series of subminiature precision resistors in a single housing of almost any configuration. The use of heat sinks and glass fiber insulation allows for wattage dissipation up

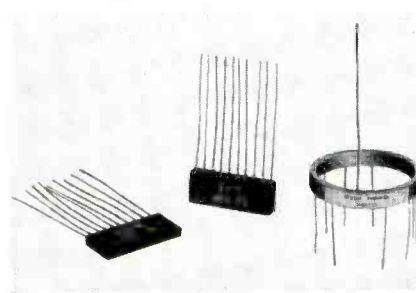

to 4 w on a ring of tapped resistors measuring approximately 1 in. in diameter and  $\frac{1}{4}$  in. high. Thickness of the ring is approximately  $\frac{1}{8}$  in.

Designed principally to meet the high reliability program of the Government's ARC-34 program, this same type of construction can be applied to any number of shapes and sizes. **Circle P5 inside back cover.**

## CERAMIC CAPACITORS

used in printed circuits

GENERAL ELECTRIC Co., Specialty Electronic Components Dept.,

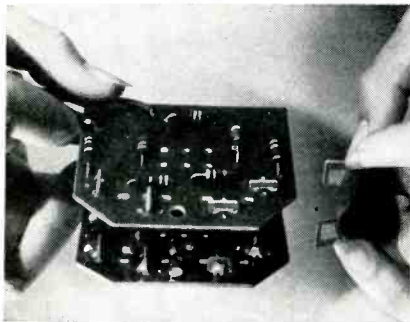

West Genesee St., Auburn, N. Y. A line of new-type, flat tapered ceramic capacitors, designed specifically for use without leads in printed wiring board circuits, has been announced. The Wejcap capacitors are inserted either manually or by placement machines into slots in the printed wiring board, and then bonded to the connection point by dip soldering.

They feature low cost, small size, high durability, and high

moisture resistance without bulky outside covering. They have several tv receiver applications, in antenna coupling networks, avc and agc networks, screen bypass and other medium-tolerance circuits.

The Wejcap capacitors are  $\frac{3}{8}$  in. high,  $\frac{3}{8}$  across at the widest point, and 35 mils thick. They have a dense, nonporous ceramic dielectric base with the silver electrode surface bonded to both sides. Values of the initial six types are 150, 270, 420, 820, 1,200 and 1,800  $\mu\text{mf}$ . **Circle P6 inside back cover.**

## POWER TRANSISTOR

operates from 12-v battery

BENDIX AVIATION CORP., 201 Westwood Ave., Long Branch, N. J., is manufacturing a new germanium *mpn* audio power transistor to operate from a 12-v battery. It can readily dissipate 5 w at a 75 C mounting base temperature and 25 w at room temperature. The collector current rating is 2 amperes at 75 C. Its power gain is 30 to 40 db and it has a-c current



gains up to 100 at 0.5 ampere collector current and 50 at 2 amperes. The JETEC designation reserved for this transistor is 2N235A. It features welded construction with a vacuum tight seal to insure long life and stable operation.

► Uses—It is suitable in applications where the 6AQ5, 6V6 or similar beam power amplifier tubes are used. The 2N235A can be used to drive automobile radio speakers, small motors and servos. There



# ELECTRO TEC SLIP RING ASSEMBLIES

## HIGH TEMP PLASTIC!

NEW ETC-7 (POLYESTER RESIN)  
USED ON ILLUSTRATED PART FOR  
HIGH TEMPERATURE OPERATION

*— for high temp applications!*

## HARD GOLD RINGS!

24 KT. SOLID GOLD RINGS —  
ENTIRE RING THICKNESS ELEC-  
TRODEPOSITED\* UNIFORM  
HARDNESS, 90 to 100 BRINELL.

COURTESY LEAR, INC.

— these two features were incorporated in  
the assembly illustrated above, having 45  
rings, dia. .180", ring width .020", barrier  
width .010". Overall length, less leads 1.763".

Electro Tec Corp., in its constant endeavor to keep pace with the most exacting requirements, has developed these new processes and products. They provide flawless performance under conditions far exceeding the capabilities of other types of construction. Where high temperature is involved, the superiority of these assemblies is so marked, that acceptance has been industry-wide. At the same time, an increasing number of users are specifying these assemblies for the ultimate in dependability under normal operating conditions. Inquiries will receive prompt attention; no obligation.

← 72 rings on integral support — no accumulated tolerances — fulfills electrical, minimum weight and space requirements.



Dual purpose assembly combining "V" grooved signal circuits and wide power rings.

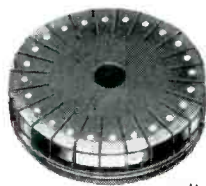

Miniature high speed sampling switch — 24 channels.

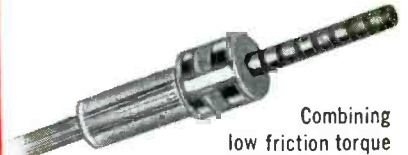

Combining low friction torque slip rings (.060 dia.) with reference switch segments.

NEW ETC-7 (POLYESTER RESIN) WITHSTANDS TEMPERATURE RANGE FROM  $-60^{\circ}$  to  $+500^{\circ}$ F.

PRODUCTS OF PRECISION CRAFTSMANSHIP  
BY A NEW AND REVOLUTIONARY PROCESS



**ELECTRO TEC  
CORP.**

SOUTH HACKENSACK, NEW JERSEY

\*PAT. NO.  
2,696,570

**RF LEAKAGE  
CONTROLLED TO LESS  
THAN  $1/10$  MICROVOLT!**

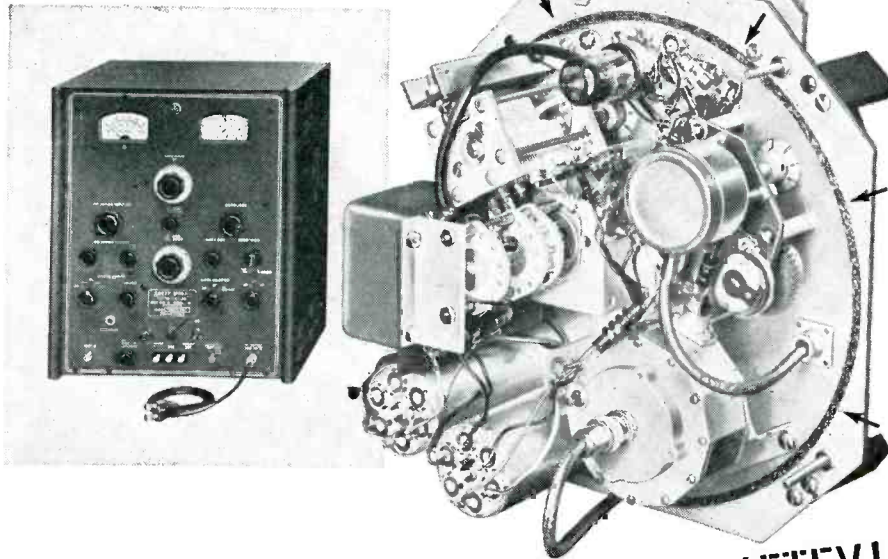

**ANOTHER PROBLEM SOLVED BY METEX!**

This Type 240-A Sweep Signal Generator built by Boonton Radio Corp., Boonton, N. J., is designed to operate at controlled output levels down to  $1/10$  microvolt. To prevent RF leakage between the oscillator chassis and oscillator cover, Boonton engineers specified a METEX RF gasket at this critical joint. This METEX RF gasket, knitted of monel wire, prevents RF leakage so successfully that peak performance is obtained at minimum output levels where leakage was previously experienced.

METEX RF Shielding, knitted of monel, aluminum or silver plated brass wire, combines maximum *conductivity* for efficient performance with inherent *resiliency* that assures continuous line contact between imperfect mating surfaces. Interlocked loops, knitted of continuous wire strands, assure maximum *cohesion*.

If you have a problem involving RF shielding in electronics or related equipment, write METEX, today!

**ELECTRONICS DIVISION  
METAL TEXTILE CORPORATION**

ROSELLE, NEW JERSEY

are numerous applications to regulator circuits, power supply circuits and high current switching circuits. Circle P7 inside back cover.



**TEST SET  
power transistor type**

BAIRD ASSOCIATES—ATOMIC INSTRUMENT Co., 33 University Road, Cambridge 38, Mass. Model KP1 power transistor test set is designed to measure all the hybrid parameters. The design feature enables the instrument to reverse either emitter current or collector voltage or both, to observe reverse d-c characteristics of the transistor under test. The unit's d-c collector ranges are 0 to 100 v and 0 to 300 ma; d-c emitter or base current range is 0 to 300 ma. Technical circular TP-105 gives additional information. Circle P8 inside back cover.

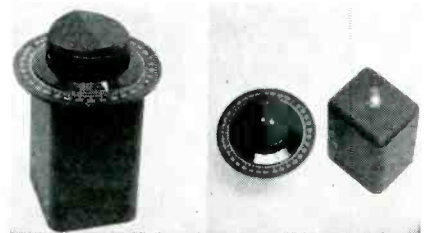

**PHASE GENERATOR  
for laboratory use**

THETA INSTRUMENT CORP., 204 Market St., E. Paterson, N. J. Catalog No. PG-1 phase generator generates a constant output voltage whose time phase varies in linear response to a dial rotation. It is used to measure transfer functions, unknown voltage phases and to provide a reference phase

6-211

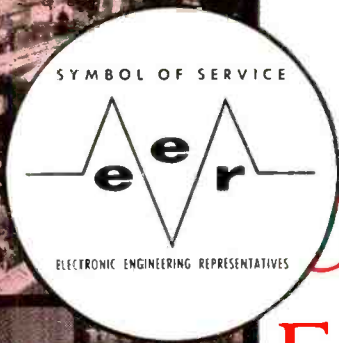

# OCTOBER ELECTRONIC EVENT

## THE SECOND ANNUAL EER ELECTRONICS ROAD SHOW

The most recent electronic instrumentation and equipment for virtually every test and measurement application, brought *direct to you* by the  
**ELECTRONIC ENGINEERING REPRESENTATIVES**

Burlingame Associates, Ltd.  
Gawler-Knoop Co.

G. Curtis Engel and Associates, Inc.  
RMC Associates

I. E. Robinson Co.

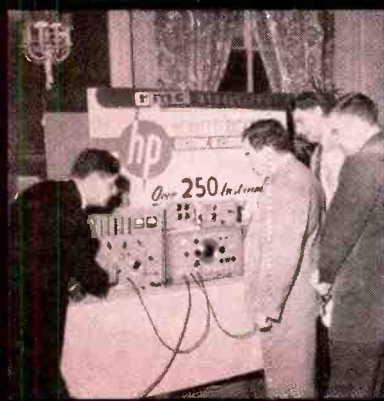
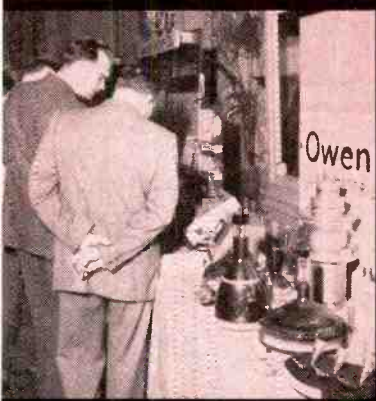
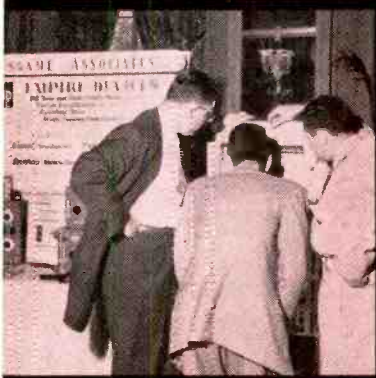
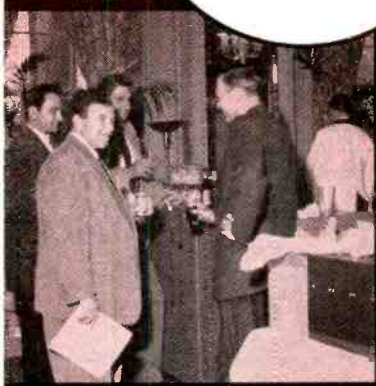
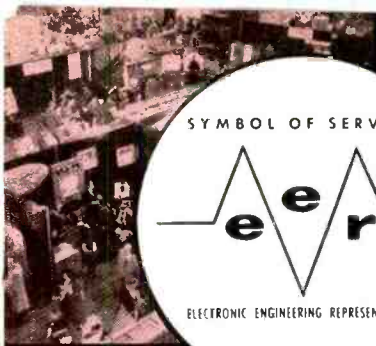

### SCHEDULE

#### OCTOBER 15

Henry Hudson Hotel  
Ninth Ave. at 57th St.  
New York City

#### OCTOBER 17

Garden City Hotel  
Garden City, L.I., N.Y.

#### OCTOBER 19

West Orange Armory  
West Orange, N.J.

#### OCTOBER 24

Penn-Sherwood Hotel  
Philadelphia, Pa.

#### OCTOBER 26

Molly Pitcher Hotel  
Red Bank, N.J.

**A KEY EVENT:** Most convenient to attend of all electronics shows, the EER Road Show brings electronic equipment right to your doorstep, at a location near your office or home.

**A "WORKING" EXHIBIT:** No "blue sky" equipment. Every piece of equipment at the EER Road Show is in current factory production and is demonstrated in actual operation.

**TECHNICAL ASSISTANCE:** The EER Road Show is leisurely paced to afford you ample time to explore all the details of the equipment you see and to discuss your application problems with experienced technical men.

**ADMISSION FREE**

**HOURS 12 NOON TO 10 P.M.**

**CHECK THE DATE THE SHOW IS IN YOUR AREA AND BE SURE TO ATTEND**

# DO YOUR PRECIOUS METAL PARTS MEET SPECIFICATIONS?

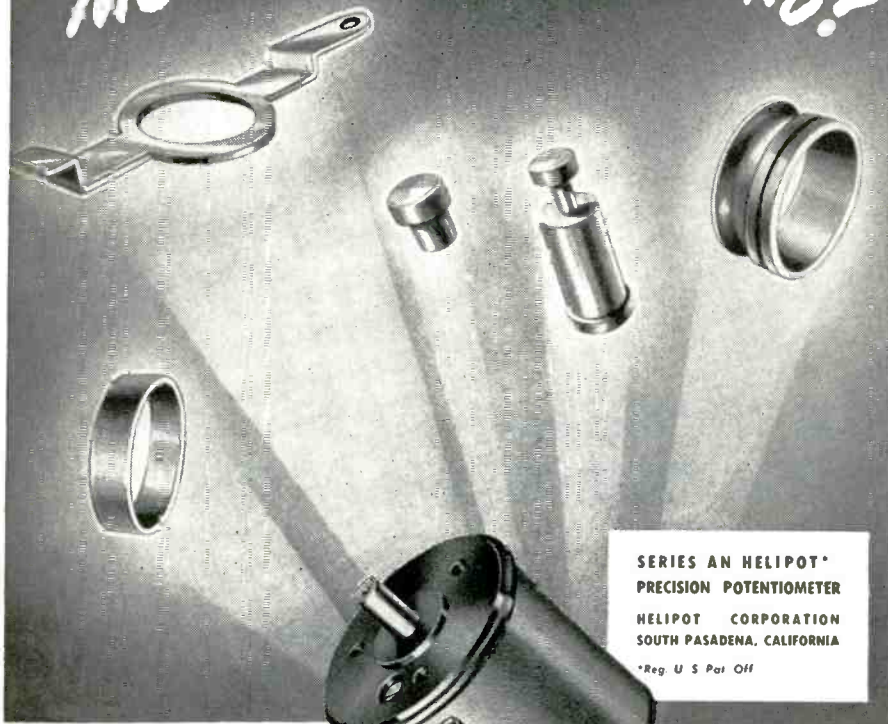

## EMPLOYS OUR EXPERIENCE TO PRODUCE PRECISION POTENTIOMETERS

Precious metal parts made to exacting specifications are regularly used by the Helipot Corporation. These and other precious metal fabrications including slip contact arms, contact rivets, slip rings (flat and cylindrical) and contact brushes are produced for many of the leading manufacturers of the electronic industry. Fifty years experience in fabricating precious metals enables us to answer your problems of dimensional tol-

erance, finish or alloy composition and properties. Maintaining high quality, making prompt deliveries at competitive prices for our many customers (like Helipot, leaders in electronics) is proof of our ability to serve you.

For recommendations and quotations contact our engineering department. We **BUILD OUR BUSINESS ON PROMPT DELIVERIES AT COMPETITIVE PRICES.**

*Mill forms of precious metals are available from our affiliate,  
LEACH & GARNER CO., Attleboro, Mass.*

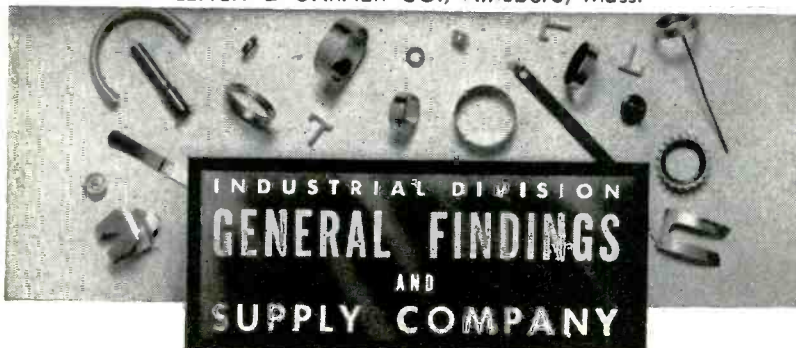

**GENERAL FINDINGS & SUPPLY COMPANY, INDUSTRIAL DIVISION, ATTLEBORO, MASS.**  
SALES OFFICES: NEW YORK - CHICAGO - LOS ANGELES

for phase-sensitive detector circuits. Completely fabricated of passive elements, it offers excellent stability and ruggedness.

Phase shift accuracies within 1 deg of the dial reading are standard, but accuracies within 5 minutes of the dial reading can be provided. Output voltage is 10 v, input is 115 v. **Circle P9 inside back cover.**

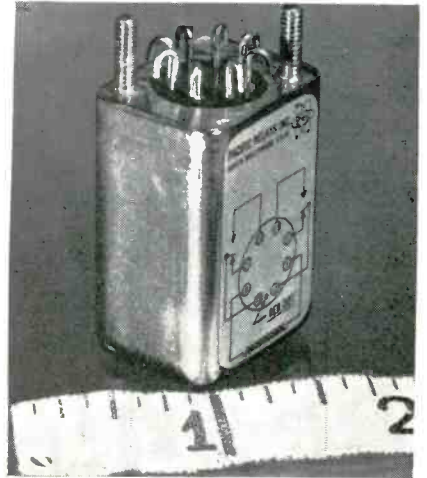

## LITTLE RELAYS in spdt or dpdt

PACIFIC RELAYS, INC., 12027 Vose St., North Hollywood, Calif., has announced new subminiature CPL relays for application where low and high temperatures are a major factor, hermetically sealed or open. They are available in spdt or dpdt, with contact ratings to 5 amperes resistive at 28 v d-c, 115 v a-c or 3 amperes inductive. It qualifies to MIL specification 6106A. **Circle P10 inside back cover.**



## PULSE GENERATOR with 1/2 sine wave output

BURROUGHS CORP., Electronic Instruments Division, 1209 Vine St., Philadelphia 7, Pa. A new pulse



**5" SCOPE — WO-91A**  
Dual-band; medium-priced; excellent for lab, production-line.



**5" SCOPE — WO-78A**  
Dual-band; "engineer's choice" for research, service, color-TV production lines.



**7" SCOPE — WO-56A**  
Direct-coupled identical "V" and "H" amplifiers; invaluable for phase measurements or vector display.



**U-F SWEEP GENERATOR — WR-86A**  
Invaluable for UHF-TV, 300 to 950 Mc; wide sweep range, high output, excellent amplitude linearity.

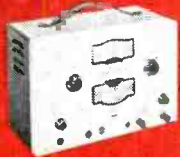

**AUDIO SIGNAL GENERATOR — WA-44A**  
Compact; 4-ranges, continuously tunable 11 cps to 100 Kc; for hi-fi measurements.

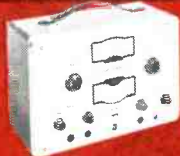

**RF SIGNAL GENERATOR — WR-49A**  
Six ranges, continuous tuning, 85 Kc to 30 Mc; for signal tracing, clipping AM and FM sets, low-frequency TV if-channels.

**5" SCOPE — WO-88A**  
General-purpose; direct-coupled; low in cost, yet high in quality.



**DOT-BAR GENERATOR — WR-36A**  
Provides small size dot pattern "H" and "V" bars, fine-line crosshatch patterns.



**MARKER-GENERATOR — WR-89A**  
Crystal-calibrated; has features required for accurate color or black-and-white TV alignment and trouble-shooting.



**TV SWEEP GENERATOR — WR-59C**  
Covers 50 Kc to 50 Mc. Tops for aligning trouble-shooting color and black-and-white TV.



**COLOR-BAR GENERATOR — WR-61E**  
Generates signals for producing 10 different color-bars simultaneously; has four crystal-controlled oscillators.



**JUNIOR VOLTOHMYST™ — WV-77B**  
"Best VTVM value;" for general applications in industry, communications, electronics fields.



**DC MICROAMMETER WV-84A**  
Ultra-sensitive; measures extremely "feeble" currents, unusually high resistances, completely portable; self-contained batteries.



**ELECTRON-TUBE M. CROMHOMETER — WT-100A**  
Versatile tube tester with accuracy approaching that of tube-factory equipment for measuring true  $g_m$ . Has many operational features especially suited for electronics equipment manufacturers, research and development, and maintenance groups... anyone desiring to test tubes under actual voltage and current conditions.



**SENIOR VOLTOHMYST™ — WV-98A**  
Rugged die-cast case; high accuracy; wide-vision meter (6 1/2" w.); for lab, production-line, general service.



**MASTER VOLTOHMYST™ — WV-87A**  
Current facilities; large meter (7 1/2"); excellent for TV radar, pulse, and other lab applications.

TAKE YOUR PICK OF THE BEST!

# RCA Test Instruments

for service • production • research

Your RCA Tube Distributor offers the most comprehensive line of high-quality test instruments available. Call him for complete details, fast delivery.



**TEST EQUIPMENT**

Radio Corporation of America • Tube Division • Harrison, N.J.

for Random Vibration Testing:  
**CALIDYNE'S**  
**NEW**

**COMPLETE,  
 MATCHED SYSTEMS**

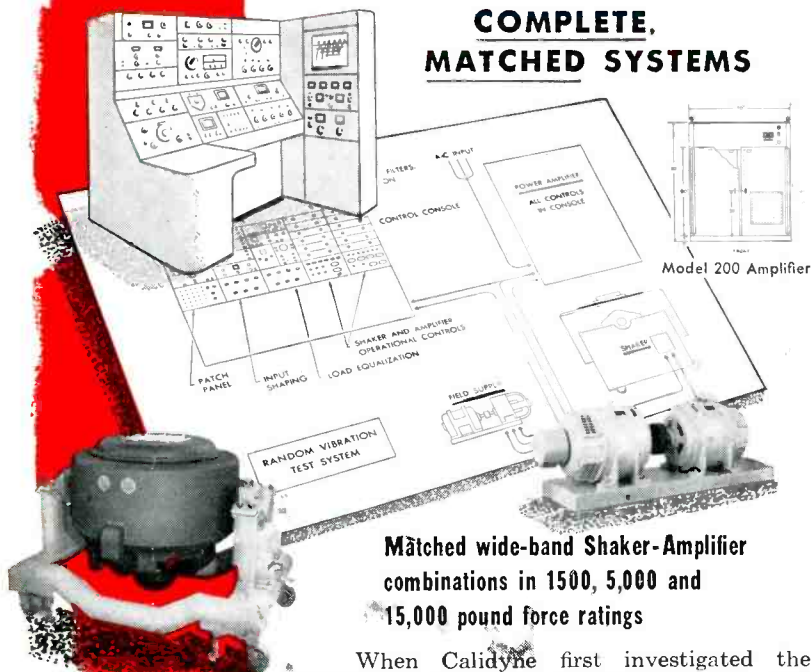

**Matched wide-band Shaker-Amplifier combinations in 1500, 5,000 and 15,000 pound force ratings**

When Calidyne first investigated the problem of building random vibration test systems, it recognized the necessity of over-all system engineering, if desired performance levels were to be achieved. That goal has now been met in what is probably the first complete, integrated system comprised of matched components.

"Wide-Band" *electrodynamical Shakers* operate at higher frequencies on lower input power, for a given armature weight and matched load rating. In random testing the load approximates the armature weight, and inherent armature rigidity maintains a high first resonance. The new *Random Noise Amplifiers* are matched power sources for the "wide band" Shakers. Made by Westinghouse to Calidyne specifications, they provide ample power for continuous duty operation at full performance. At the same time they are capable of supplying instantaneous power peaks for random noise tests.

The *Model 188 Console* is a typical control unit for any of several systems. It contains basic Shaker-Amplifier operating controls, input shaping and compensation circuits, plus monitoring and other control equipment. With these components, Field Power Supplies complete the over-all system.

Performance data and specifications available on request.

Call Calidyne for competent application engineering assistance.



THE  
**CALIDYNE**  
 COMPANY

120 Cross Street, Winchester, Mass.

**SALES REPRESENTATIVES:**

WALTHAM, MASS.  
 Robert A. Waters, Inc.  
 Waltham 5-6900

NEW HAVEN, CONN.  
 Robert A. Waters, Inc.  
 Fulton 7-6760

NEW YORK CITY AREA  
 G. C. Engel & Associates  
 Rector 2-0091

RIDGEWOOD, NEW JERSEY  
 G. C. Engel & Associates  
 Gilbert 4-0878

PHILADELPHIA, PA.  
 G. C. Engel  
 Chestnut Hill 8-0892

NORTHERN NEW YORK  
 Technical Instruments, Inc.  
 Waltham, Mass.  
 Waltham 5-8445

CLEVELAND, OHIO  
 M. P. Odell Co.  
 Prospect 1-6171

DAYTON, OHIO  
 M. P. Odell Co.  
 Oregon 4441

DETROIT, MICHIGAN  
 M. P. Odell Co.  
 Superior 8-5114

DENVER, COLORADO  
 Gerald B. Miller Co.  
 Acama 2-9276

WASHINGTON, D. C.  
 F. R. Jordan, Inc.  
 Hobart 2-4300

SEATTLE, WASH.  
 G. B. Miller Co.  
 Lander 3320

CHICAGO, ILLINOIS  
 Hugh Marland & Co.  
 Ambassador 2-1555

INDIANAPOLIS, INDIANA  
 Hugh Marland & Co.  
 Glendale 3803

MINNEAPOLIS, MINN.  
 Hugh Marland & Co.  
 Colfax 7949

DALLAS, TEXAS  
 John A. Green Co.  
 Riverside 3266

HOLLYWOOD, CALIFORNIA  
 G. B. Miller Co.  
 Hollywood 2-1195

SAN FRANCISCO, CALIF.  
 G. B. Miller Co.  
 Lytell 3-3438

SOUTHEAST  
 Specialized Equipment Corp.  
 P. O. Box 323 Cocoa Beach, Fla.  
 Cocoa Beach 3328

ALBUQUERQUE, NEW MEXICO  
 G. B. Miller Co.  
 Albuquerque 5-8606

CANADA  
 Measurement Engineering Ltd.  
 Annprior, Ont., Phone 400  
 Toronto, Ont., Mayfair 8860

EXPORT  
 Rocke International Corp.  
 13 East 40th St., N. Y. 16, N. Y.  
 Murray Hill 9-0200

generator, the stable source of usable pulses necessary in the application of digital techniques through a pulse control system, has just been developed for use wherever extra high frequencies are required.

Type 1050 has independent controls for pulse frequency, duration, amplitude and polarity easily adjusted by clearly marked dials on the front panel of the 19 in. by 3½ in. by 10 in. standard rack-mounted unit.

► **Further Data**—Output is a ½ sinewave covering an adjustable frequency range from 1.6 mc to 10.4 mc in four overlapping bands. Pulse width is adjustable from 0.03 μsec to 0.07 μsec, in five bands. Amplitude is adjustable from 10 v to 32 v with either polarity. Circle P11 inside back cover.

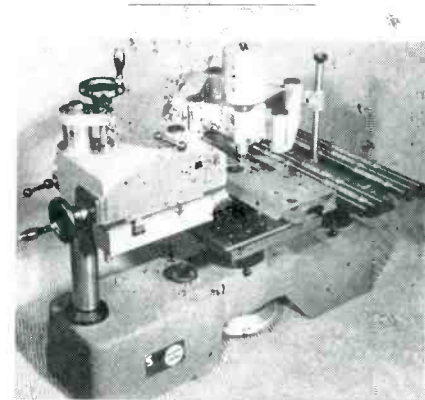

**ENGRAVING MACHINES**  
 simple and inexpensive

SCRIPTA MACHINES A GRAVER, 7, Passage Turquetil, Paris 11, France. The Scripta SD engraving machine is a simplified compact unit weighing only 30 lb, which provides high-precision all-purpose engraving at low cost. Designed so anyone in the shop can do his own engraving without training or trouble, the Scripta model SD combines a fixed-ratio pantograph with a series of grooved stencil-alphabets. By simply following the grooves with the tracing stylus, engraving may be done as rapidly as hand-lettering (2 to 4 sec per character).

A system of clamps holds stencils and workpiece in rigid relationship; a high-speed cutter on the pantograph does the actual engraving. The SD is capable of



Computer manufacturers know General Transistor always delivers reliability. That's why they depend on GT quality and GT service, and that's why General Transistor is one of the largest suppliers of transistors for computers.

## FOR COMPUTER RELIABILITY IT'S GENERAL TRANSISTOR

The Univac® File-Computer, a new intermediate sized data processing system designed and manufactured by Remington Rand Univac Division of Sperry Rand Corporation.

Write for Specification Bulletins covering your applications.

GENERAL TRANSISTOR CORP.  
Richmond Hill 18, N. Y.  
Virginia 9-8900

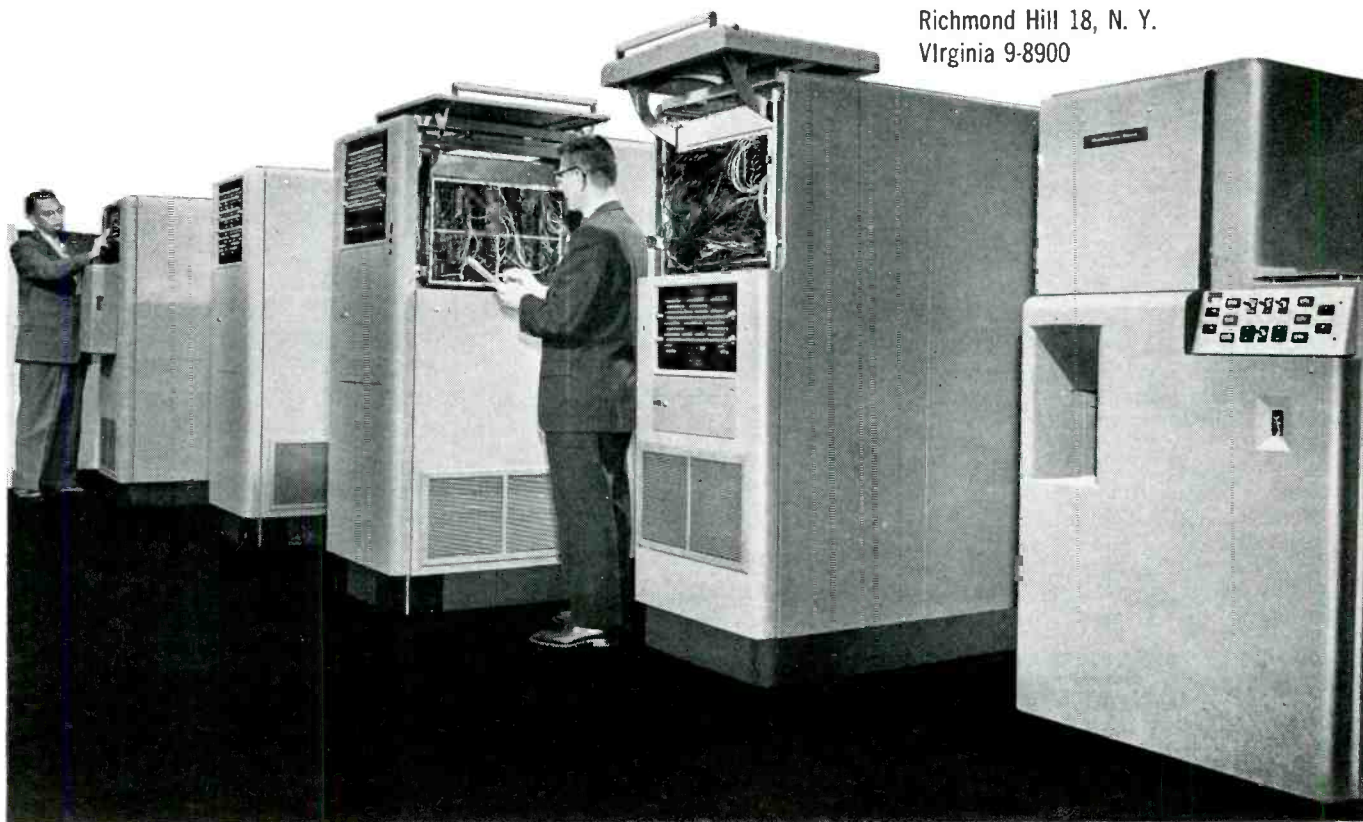

engraving all materials, from plastics to the hardest steel, and accommodates workpieces up to a foot high.

► **Applications**—Some of the many uses of the instrument include engraving nomenclature on printed circuit boards, instrument panels, dials, circular divisions and the like. It can also be used for engraving on curved or irregular surfaces. Circle P12 inside back cover.



**PARABOLIC ANTENNA**  
for tropospheric scatter

PRODELIN, INC., 307 Bergen Ave., Kearny, N. J., has available a new 28-ft parabolic antenna for tropospheric scatter transmission. Antenna feeds have been designed for use in the 450 to 2,700 mc range.

Utilizing an aluminum mesh reflecting surface and back-up support, a 65-lb wind load rating is provided. The antenna achieves excellent structural stability through the use of tower K frame construction using all aluminum members.

A new design feature permits the raising and lowering of the antenna feed to facilitate installation and maintenance. To eliminate transportation problems and minimize damage normally attendant to the shipment of large crate items, this antenna is shipped in 12 sections each of the reflecting surface and "K" frame members,

*when you need a*  
**SMALLER "POT"**  
*Try these for size and reliability...*

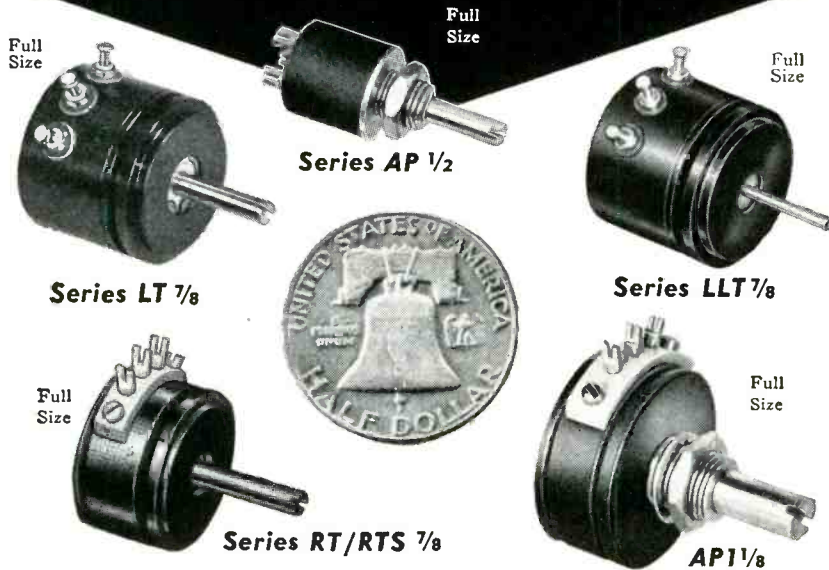

**Waters miniature and micro-miniature  
wire-wound precision potentiometers**

are famous for accuracy, ruggedness, dependability and fast delivery in commercial and military uses. They are precision-machined, with anodized aluminum bodies, line-reamed phosphor bronze, ball or jewel bearings, centerless-ground stainless steel shafts, and gold-plated fork terminals; fully sealed and fungus-proofed. To meet your requirements Waters pots can be furnished ganged, tapped, servo or bushing mounts, with various electrical and mechanical angles, optional shaft locks, anti-rotation pins, 0 rings, and custom shaft or servo dimensions.

**Series AP 1/2** — 2 watts continuous at 80°C; resistances 10 to 100,000 ohms, 5% tolerance standard; diameter 1/2", depth 1/2" standard, weight 1/4 ounce; fully sealed for potting.

**Series LT/LLT 7/8** — One watt at 80°C; resistances 100 to 100,000 ohms, ball or jewel bearing, for use in computers, servos, and selsyns where minimum torque is required. Weight is only 1/2 ounce; MAXIMUM torque is 0.01 inch-ounce per section. Ganging to six decks, internal clamps hold 7/8" diameter. Standard linearity 0.5%, on special order 0.25% above 1K; toroidal winding allows winding angles to 360°, standard is 354°.

**Series RT/RTS 7/8** — 3 watts continuous at 80°C; resistances 10 to 100,000 ohms; diameter 7/8", depth 3/8", weight 1/2 ounce; standard linearity 2%.

**Series AP1 1/8** — 4 watts continuous at 80°C; resistances 10 to 150,000 ohms; diameter 1 1/8", depth 1/2", weight less than 3/4 ounce; standard linearity 1%.

Waters has advanced facilities for the design and manufacture of miniature toroidal potentiometers and windings for use in equipment of special design.

*Write today for complete information on all Waters potentiometers.*

**Waters**  
MANUFACTURING, inc.

APPLICATION ENGINEERING OFFICES  
IN PRINCIPAL CITIES

Wayland, Massachusetts  
P. O. Box 368, So. Sudbury, Mass.





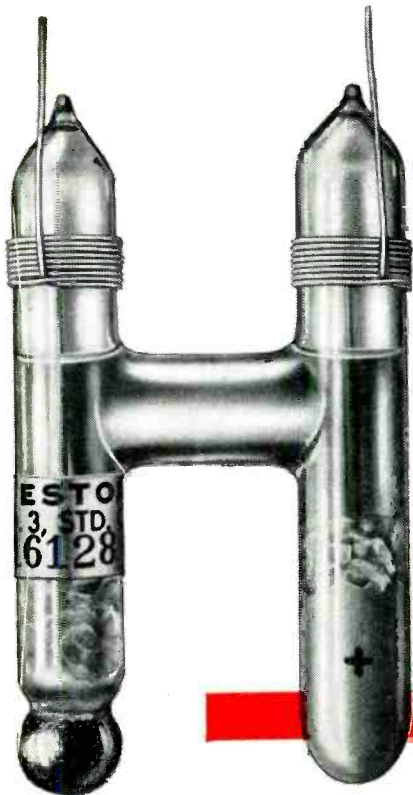

# HOW TO BE SURE A VOLT IS A VOLT...



The Weston Standard Cell Comparator Model 1000, made by Weston Electrical Instrument Corp.,\* Newark, N. J., with associated milliameters, dry cells, main galvanometer, and auxiliary standard cell.

This H-shaped object, the saturated or "normal" form of the Weston Standard Cell, is the standard reference for electrical measurements. It is essentially a mercury cadmium wet cell hermetically sealed in glass. When kept at 20 degrees C., it maintains its voltage of 1.018636 volts for years. A bank of these cells at the Bureau of Standards in Washington, kept under oil at a constant temperature, is the basic electrical standard of the United States. This, however, is not the cell used by scientists and engineers in their daily work. Since the normal cell must be maintained at a constant temperature for accurate results, the unsaturated or "working" cell, which is portable and is not materially affected by temperature, is ordinarily used.

These working cells must be periodically checked against a bank of normal cells through the use of a comparator system. In the past only a few comparators existed outside the Bureau of Standards. However, the Weston Electrical Instrument Corporation has produced a simplified Standard Cell Comparator which provides the user of working cells, in conjunction with this own bank of temperature controlled normal cells, with an accurate means of standardizing these right in his own plant . . . at a great saving in time, cost and convenience.

#### THE WESTON COMPARATOR

The Weston Standard Cell Comparator is a specialized

potentiometer wherein the voltage of a working cell under test is opposed to that of a normal cell to produce a voltage difference which, when added algebraically to the normal cell voltage, indicates directly the voltage of the cell under test. With a known normal cell voltage as a reference, the Comparator will measure to well within 5 microvolts the open circuit voltage of any cell in good condition.

With an instrument calibrated to such excellent accuracy as this one, it is worthy of note that Weston uses Driver-Harris Manganin wire for critical resistance networks in its system. Says Weston: "The success of the entire circuit, given accuracy of adjustment, depends upon the permanency of the Manganin, and upon its extremely low temperature coefficient of resistance and its low thermal emf to copper".

Your work may or may not need the extreme degree of accuracy that is a prerequisite here. Either way, Driver-Harris has an alloy that can reliably fill your needs. Manganin is only one of 112 special purpose alloys, produced by Driver-Harris. And each of these was originally custom-made . . . produced exactly to the specifications of someone who needed it. Put your specifications in our hands. You will gain the benefits of the 57 years of experience which has developed the largest variety of alloys ever made by any one company.

\*A subsidiary of Daystrom, Inc.



## Driver-Harris

COMPANY

HARRISON, NEW JERSEY

BRANCHES: Chicago, Detroit, Cleveland, Louisville, Los Angeles, San Francisco • In Canada: The B. GREENING WIRE COMPANY, Ltd., Hamilton, Ontario

MAKERS OF THE MOST COMPLETE LINE OF ELECTRIC HEATING, RESISTANCE, AND ELECTRONIC ALLOYS IN THE WORLD

for complex **WAVEGUIDE** assemblies like this



Technicraft's advanced design, engineering and manufacturing facilities are available to serve your needs from the face of the Magnetron through to the antenna.

**MAKE**

## **TECHNICRAFT**

**YOUR PRIMARY SOURCE**

*Designed with Precision*

*Built with Precision*

*Tested with Precision*

One of our representatives is near you. Sales engineering offices in: Dallas • Dayton • Los Angeles  
Chicago • Seattle • St. Louis • Toronto (Canada).

**SERVING RADAR AND COMMUNICATIONS WITH THE  
BEST IN MICROWAVE TRANSMISSION DEVICES**

### **TECHNICRAFT LABORATORIES**

1550 THOMASTON RD. • THOMASTON, CONNECTICUT

Designers and Manufacturers of Rigid and Flexible Waveguide Assemblies, Microwave Test Plumbing and Components, Waveguide Systems.

NEW PRODUCTS

(continued)

and then enclosed into two easy-to-handle shipping boxes. Circle P13 inside back cover.

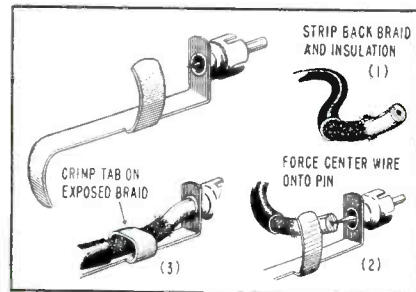

### **PHONO PLUG** eliminates soldering

WORKMAN TV INC., 309 Queen Anne Road, Teaneck, N. J. A new type of phono plug is especially designed to eliminate soldering. Easily attached in one minute, model No. PP solderless phono plug can be used with any coax cable or shielded wire commonly used in audio. The curved finger pull allows easy insertion or removal of the phono plug without undue stress on either the plug or the attached cable, thus eliminating broken wires or pulled-out pins.

Installation is accomplished by first firmly forcing the center conductor of the cable or wire onto the sharp pin of the solderless phono plug and then tightly crimping the side tab of the phono plug over the exposed shield braid of the cable. Circle P14 inside back cover.

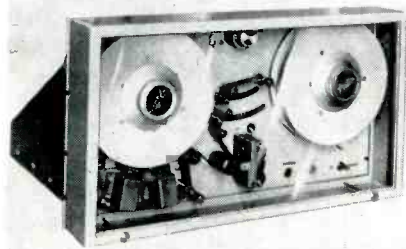

### **MAGNETIC TAPE HANDLERS** for airborne use

POTTER INSTRUMENT Co., INC., 115 Cutter Mill Road, Great Neck, N. Y., has announced a new series of airborne magnetic tape handlers. Model 3186 is available for

THE  
**A B C**  
 OF  
**1 2 3**

## Why is COUNTROL important in every business today?

Countless times a day, every business needs to know "how many? . . . how much? . . . how far? . . ." and many other questions that can be answered only by facts-in-figures. But how to get these figures . . . from so many different machines, processes, operations and systems? Veeder-Root Counters are doing it every day, by means of:

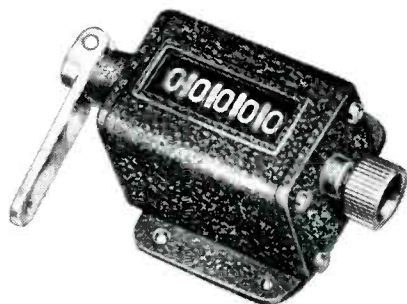

### MECHANICAL COUNTING

Small Resets count strokes, turns, or pieces . . . are used by thousands for moderate duty in parts inspection, quality control, conveyors, machine tools, light presses, etc.



### HAND COUNTING

Where objects or units cannot be counted electrically or mechanically, hand-operated counters like this Hand Tally do the job. For instance, quick spot checks of production or performance, traffic count, inventory, etc. Fits palm of hand, counts one for each pressure of thumb lever, resets to zero by turning knob.

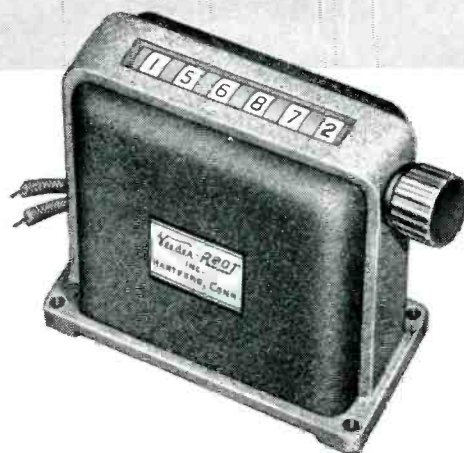

### ELECTRICAL COUNTING

These remote-indicating counters bring your production machines as close as your office wall. AC or DC, they can be connected in series with any simple switch, and will transmit production figures *instantly* over any distance. May be panel-mounted in groups.

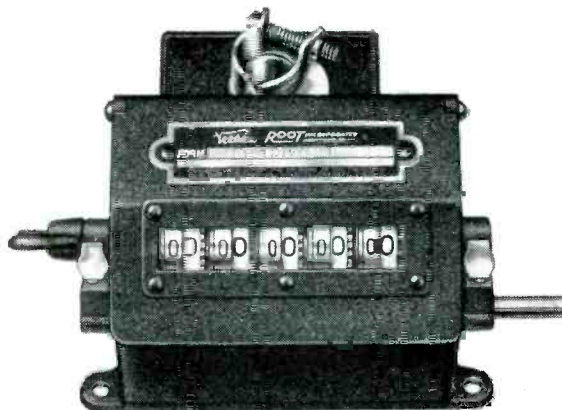

### CONTROLLING

Set it for the exact number of turns, pieces, or operations required . . . and this Predetermining Counter will control the run *exactly* . . . preventing over-runs and shortages. When the predetermined number is reached, counter will light a light, ring a bell, or actuate a stop-motion.

**IN SUM:** *If it can be counted or controlled . . . count on Veeder-Root to do it. Get in touch with your Industrial Supply Distributor for standard counters for application to your production machines and processes. And get in touch with Veeder-Root for counters to be built into original equipment. Veeder-Root Inc., Hartford 2, Connecticut.*

Insist on Standard  
**VEEDER-ROOT**  
**COUNTERS**  
 from your Industrial  
 Supply Distributor



# SPECTROL

## Precision

## Potentiometers

### MODEL 100



Precision 1 3/8" dia. single-turn potentiometer. Standard Resistance Range—10 $\Omega$  to 30 K $\Omega$   $\pm$ 3.0%. Standard linearity  $\pm$ 0.5%. May be ganged—2 to 15 sections. Up to 14 extra taps per section.

### MODEL 200

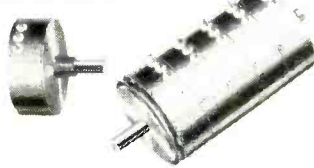

Precision 1 3/4" dia. single-turn potentiometer. Standard Resistance Range—5 $\Omega$  to 65 K $\Omega$   $\pm$ 3.0%. Standard linearity  $\pm$ 0.3%. May be ganged—2 to 15 sections. Up to 21 extra taps per section.

### MODEL 300



Precision 2" dia. single-turn potentiometer. Standard Resistance Range—20 $\Omega$  to 75 K $\Omega$   $\pm$ 3.0%. Standard linearity  $\pm$ 0.3%. May be ganged—2 to 15 sections. Up to 21 extra taps per section.

### MODEL 400

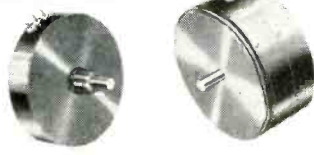

Precision 3" dia. single-turn potentiometer. Standard Resistance Range—100 $\Omega$  to 100 K $\Omega$   $\pm$ 3.0%. Standard linearity  $\pm$ 0.3%. May be ganged—2 to 15 sections. Up to 33 extra taps per section.

### MODEL 500



Precision 7/8" dia. miniature 10-turn potentiometer. Standard Resistance Range—25 $\Omega$  to 120 K $\Omega$   $\pm$ 3.0%. Standard linearity  $\pm$ 0.3%. Up to 38 extra taps per section.

### MODEL 700

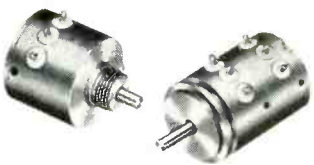

Precision 7/8" dia. miniature single-turn potentiometer. Standard Resistance Range—10 $\Omega$  to 20 K $\Omega$   $\pm$ 3.0%. Standard linearity  $\pm$ 0.5%. May be ganged—2 to 6 sections. Up to 9 extra taps per section.

### MODEL 800



Precision 1 1/8" dia. 10-turn potentiometer. Standard Resistance Range—50 $\Omega$  to 400 K $\Omega$   $\pm$ 3.0%. Standard linearity  $\pm$ 0.3%. May be ganged—2 to 3 sections. Up to 48 extra taps per section.

### MODEL 850



Precision 1 1/4" dia. 3-turn potentiometer. Standard Resistance Range—20 $\Omega$  to 120 K $\Omega$   $\pm$ 3.0%. Standard linearity  $\pm$ 0.3%. May be ganged—2 to 3 sections. Up to 18 extra taps per section.

Spectrol potentiometers may be tailored to comply with a wide variety of electrical and mechanical requirements.

Write for complete details

SPECTROL

**SPECTROL ELECTRONICS  
DIVISION OF  
CARRIER CORPORATION**

1704 South Del Mar, San Gabriel, California

operation on either 60 or 400 cycle power. Standard 1-in. wide magnetic tape is used with an interlaced head stack arrangement that provides 25 data channels. Tape speed is 54 ips on standard models, but other tape speeds can be accommodated. Fast starts and stops (0.6 sec) to add from full speed permits maximum utilization of recording medium. Standard 2,400-ft NARTB reels are used and adapters are available for other reel types.

Tape travel may be controlled by front panel switch or remote contact closure. Tape drive is automatically halted in the event of tape or power failure. Although intended primarily for digital recording, wow and flutter are held to less than 3 percent peak-to-peak when a signal is recorded and reproduced on the same machine, thus satisfying requirements of many analog recording applications. Model 3186 can operate over wide variations in environmental conditions. Circle P15 inside back cover.

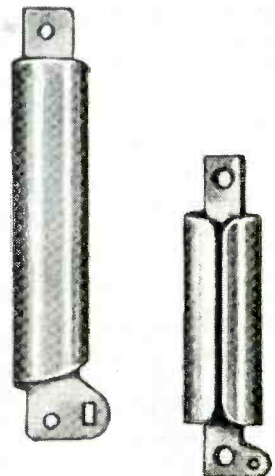

T 3-L

T 3-H

## SHIELD MOUNTS two new types

NEMS-CLARKE, INC., 919 Jesup-Blair Drive, Silver Spring, Md., has available two new shield mounts—the T-3L and T-3H. The T-3H is designed for heavy duty use and when higher period of vibrations is encountered. It is made

**1949**— Ferramic A Magnetic Core Material, first produced by General Ceramics in 1949, gave sufficient promise of useability as a gyrator element to encourage General Ceramics engineers to further develop the Faraday rotational effects of Ferrites.

**1952**— Variations of Schoenberg's original formula resulted in MF 1331 in May, 1952.



**1953**— Other refinements resulted in General Ceramics Ferramic R1, available for several years for X Band applications.

# Progress Report

by **GENERAL CERAMICS**  
on the development of

# MICROWAVE FERRITES

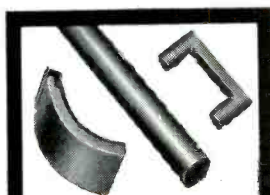

TV and Radio Cores



Magnetic Memory Cores

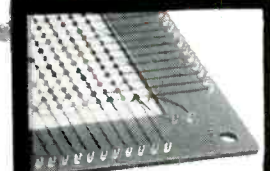

Magnetic Memory Planes



General Purpose Cores



Recording Head Cores



Microwave Ferrites

## Now S Band Ferramic R4 is available!

This new ferrite material, designated Ferramic R4 by General Ceramics, is suitable for use in many S Band applications. Complete information will be supplied on receipt of full details of your specific application. Please address inquiries to Dept. E.

### Properties of Ferramic R1

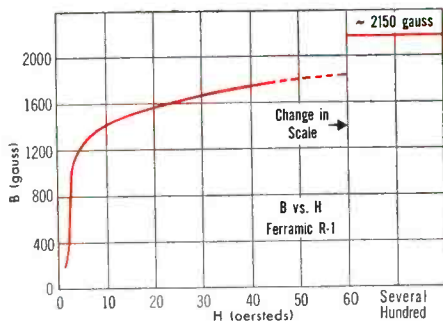

Frequency CPS	Dielectric Properties		Magnetic Properties	
	$\Sigma / \Sigma_d$	$\tan \delta_d$	$\mu' / \mu_0$	$\tan \delta_m$
$10^9$	13	.007	3	1.5
$1.5 \times 10^9$	13	.006	1.7	2.6
$3 \times 10^9$	13	.004	0	200 (peak)
$10^{10}$	13	.002	+ .7	.004

Curie Temperature .....  $270^\circ\text{C}$   
Volume Resistivity ..... High  
Density ..... 4.3 grams/cc

**General CERAMICS CORPORATION**  
Telephone VALLEY 6-5100  
General Offices and Plant: KEASBEY, NEW JERSEY

MANUFACTURERS OF FERRAMIC CORES, MAGNETIC MEMORY CORES, MEMORY PLANES, MICROWAVE FERRITES, SOLDERSEAL TERMINALS, HIGH TEMP. SEALS, STEATITE, ALUMINA & CHEMICAL STONEWARE

# NEW



Patents Pending

## NYLON COIL FORMS

A NEW PRODUCT INTRODUCED BY

# CLEVELAND CONTAINER CO.

Makers of CLEVELITE\* . . .  
the QUALITY name for Phenolic Tubing

### CLEVELAND'S NYLON FORMS . . .

- . . . are a one-piece precision molded, high temperature form for use with threaded cores.
- . . . eliminate costly assembly operations as they can be had with the collar as an integral part of the form.
- . . . collars are notched to prevent slipping turns, speeding winding operations.
- . . . edges are serrated to provide greater friction when engaged with winding arbor.
- . . . have six internal ribs enabling cores to be pressed into the form, eliminating time consuming, hand threading operations.
- . . . have unique patented chassis lock, eliminating costly mounting clips.
- . . . resist electrolysis indefinitely.
- . . . available in all R.E.T.M.A. standard colors, for easy identification . . . in certain lengths to fit 8/32 and 1/4-28 core sizes.

\* Reg. U. S. Pat. Off.

## THE CLEVELAND CONTAINER COMPANY

6201 BARBERTON AVE. CLEVELAND 2, OHIO  
PLANTS AND SALES OFFICES:

CHICAGO • DETROIT • MEMPHIS • PLYMOUTH, WIS. • OODENSBURG, N.Y. • JAMESBURG, N.J. • LOS ANGELES

ABRASIVE DIVISION of CLEVELAND, OHIO  
Cleveland Container Canada, Ltd., Prescott and Toronto, Ont.

**Representatives:**

NEW YORK AREA: R. T. MURRAY, 604 CENTRAL AVE., EAST ORANGE, N. J.  
NEW ENGLAND: R. S. PETTIGREW & CO., 62 LA SALLE RD., WEST HARTFORD, CONN.  
CHICAGO AREA: PLASTIC TUBING SALES, 5215 N. RAVENSWOOD AVE., CHICAGO  
WEST COAST: IRV. M. COCHRANE CO., 408 S. ALVARADO ST., LOS ANGELES



of 0.015 thick phosphor bronze. The T-3L is designed for use with T-3 bulb size tubes 1 1/4 in. in length. The greater surface contact area provides a higher degree of clamping and more surface area for additional heat dissipation. It is made of 0.008 phosphor bronze. Circle P16 inside back cover.



### SERVO AMPLIFIER small, transistorized

M. TEN BOSCH, INC., Pleasantville, N. Y. Model 1800-0300 is a miniaturized, hermetically-sealed, plug-in transistor servo amplifier. It is primarily intended to receive signals from a synchro control transformer and to operate a size 15, 400-cycle, 6.1-w servo motor or equivalent. The amplifier is designed to meet the environmental requirements of specification MIL-E-5400. Complete physical and electrical specifications are available from the company. Circle P17 inside back cover.



### PRECISION POT a single-turn unit

HELIPOT CORP., 916 Meridian Ave., South Pasadena, Calif. Series 5600 precision potentiometer is a 2 in. diameter, single-turn unit for

# putting **IDEAS** to work—research at **IBM**

- **Random Access Memory Accounting:** RAMAC®, magnetic-disk memory storage, gives fast access to 5,000,000 characters. IBM Bulletin No. 400.
- **Slanting Rain:** “Shadows” created on a surface by its irregularities and discontinuities magnified 200,000 times through electron microscopy.

*For bulletins, write to Dept. EL-10, IBM, 590 Madison Ave., New York 22, N. Y.*

## Random Access Memory Accounting

RAMAC, IBM's newest data processing system, needed a unique memory storage system. Ordinary methods of memory storage—magnetic tape, drums, ferrite cores—couldn't store enough “bits” of information. It took a research team of ours, with Trigg Noyes and Wes Dickinson as key men at IBM's San Jose Research Labs, to find the answer. The heart of this new idea: magnetic disks, played and replayed like the records in coin-operated music machines!

Here's how it works: Information is stored, magnetically, on fifty disks which rotate at 1200 rpm. These disks are mounted so as to rotate about a vertical axis, with a spacing of three tenths of an inch between disks. This spacing permits two magnetic heads to be positioned to any one of the 100 concentric tracks which are available on each side of each disk. Each track contains 500 alphanumeric characters. Total storage capacity: 5,000,000 characters. The two recording heads are mounted in a pair of arms which are moved, by a feed-back control system, in a radial direction to straddle a selected disk.

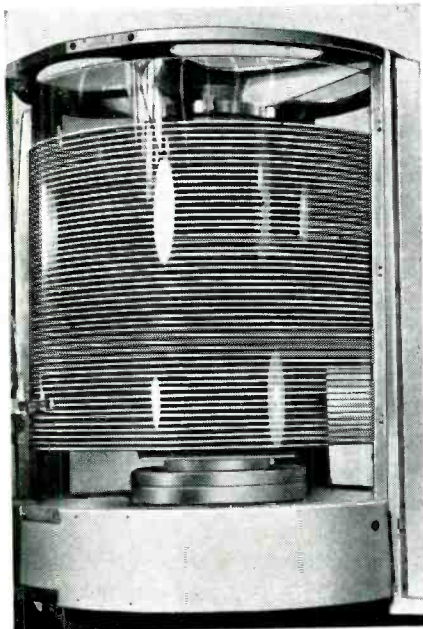

*RAMAC's memory*

This new system promises memory storage possibilities never before accomplished. If you'd like to read more about the engineering design of this magnetic-disk, random access memory system, write for IBM Bulletin No. 400.

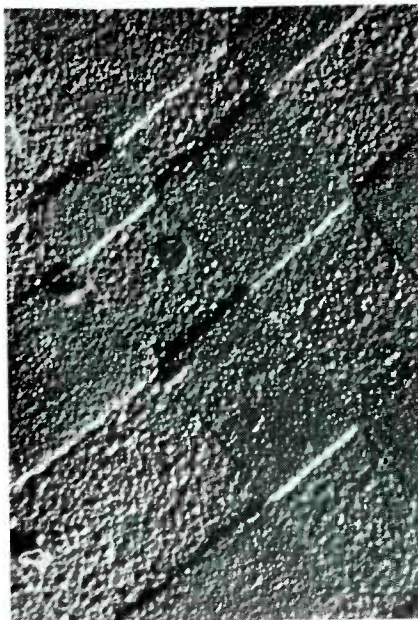

*Blown-up shadows*

## Slanting Rain

All of us have stood on a tall building on a cloudy day and looked down at the street—pretty difficult to judge relative heights of objects that far below, wasn't it? But during late afternoon on a sunny day the lengths of shadows made your estimates of height as easy as apple pie. The 100,000-volt Electron Microscope at our Poughkeepsie Research Laboratory allows us to study the topography of surfaces in just the same way. Instead of relying upon the obstruction of light by objects on a surface, we cause them to obstruct a slanting rain of metal vapor. Where the rain falls on a thin collodion

coating previously put on the surface, the transmissibility of electrons through the coating is altered when it is put into the Electron Microscope; the “shadows” can be magnified and recorded on photographic film. A photographic enlargement made from the film can result in magnification of 200,000 times, thus making it possible to clearly observe an object less than one ten-millionth of an inch in diameter; or, this dash, —, magnified to the extent that it would appear to be about ¼ mile long. This magnification is about 200 times greater than practical in light microscopy, primarily because of the greater resolution possible in the EM, due to the short effective wave length of electrons.

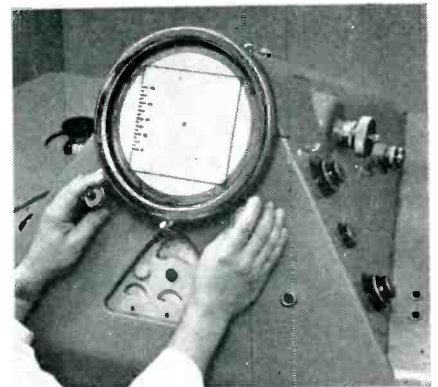

*Poughkeepsie's EM*

We regard the electron microscope as one of our most important research tools. It has in some cases provided the missing data needed to understand the interrelation of the variables in a problem; has in other cases allowed us to confirm a proposed new theory.

*To learn more about career opportunities available at IBM, write, describing your background, to: W. M. Hoyt, IBM, Room 410, 590 Madison Avenue, New York 22, N. Y.*

**IBM**

**INTERNATIONAL  
BUSINESS MACHINES  
CORPORATION**

DATA PROCESSING • ELECTRIC TYPEWRITERS • TIME EQUIPMENT • MILITARY PRODUCTS

Want more information? Use post card on last page.

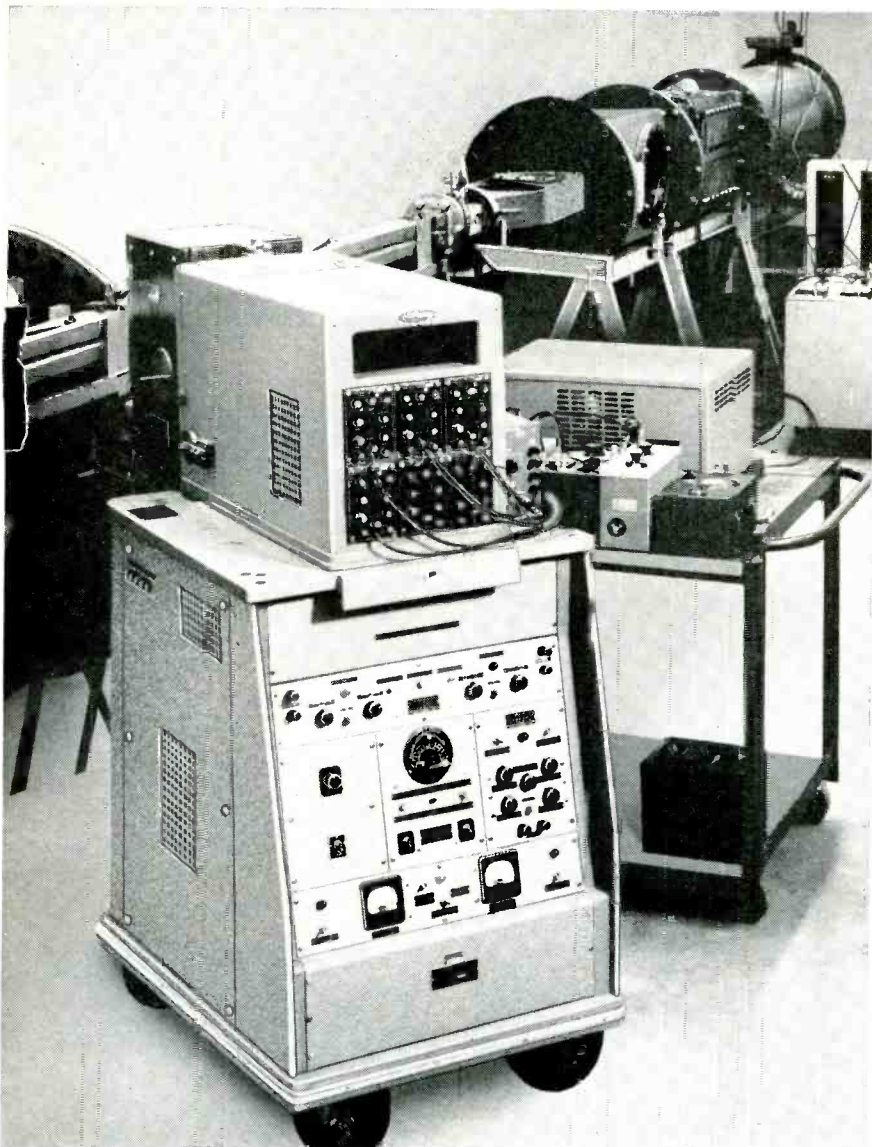

## SC-16B RECORDS Missile Flight Conditions at Cornell Aeronautical Laboratory

Missile flight conditions . . . speeds of 10,000 miles per hour . . . temperatures as high as 7,000°K . . . are faithfully simulated in Cornell Aeronautical Laboratory's hypersonic shock tunnel by blowing a column of air, accelerated by a strong shock wave, past a model.

Backbone of recording instrumentation is the dependable Hathaway SC-16B Cathode Ray Recording Oscillograph. Accurate records of several channels of high speed phenomena . . . pressure, temperature, ionization . . . are simultaneously recorded on a common time base by the versatile, high frequency SC-16B.

However complex your recording problem, Hathaway can provide the standard or custom instrument to fully meet your needs.

Write for Bulletin I-10 describing the SC-16B's many features—chart speed 1.6 to 6000 in/sec; up to 12 channels; frequency response d-c to 200 kc and writing rate of 5,000,000 in/sec.

# Hathaway

INSTRUMENT DIVISION

# Hamilton

WATCH COMPANY

1315 SOUTH CLARKSON • DENVER, COLORADO

servo or bushing mounting, with or without ball bearings. Up to 8 sections can be ganged on a common shaft at the factory with as many as 21 taps to a section.

► **Specifications**—A wide range of total resistance is provided (from 35 to 80,000 ohms) and linearity as close as  $\pm 0.15$  percent is available. The series 5600 is a continuous-rotation potentiometer, with electrical rotation of 356 deg  $\pm 1$  deg. Housed in a dimensionally stable, one-piece plastic cup, it weighs only 3.2 oz. Operating range is  $-55$  C to  $+80$  C. Power rating is 4.8 w at 25 C ambient and 3.5 w at 40 C ambient.

The series 5600 also offers a wide choice of modifications which adapt the new potentiometer to meet exact specifications. Circle P18 inside back cover.

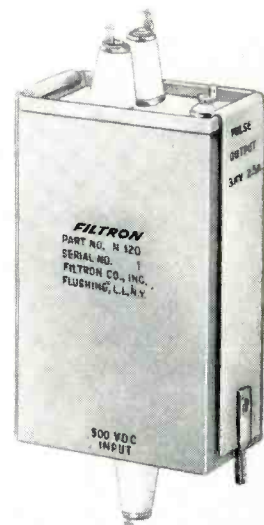

## PULSE PACKAGES aid radar system designers

FILTRON Co., Inc., Flushing, L. I., N. Y. Radar transmitter engineers can now obtain preengineered and preassembled radar components, which, when installed in their systems, will furnish outputs guaranteed to meet reasonable performance requirements of any specific radar system employing a hydrogen thyratron tube. These components, which are the main determinants of the transmitted-pulse parameters of a radar system, are available as a package.

The high power pulse package is built around the charging choke,



**DESIGN**  
**DEVELOPMENT**  
**PRODUCTION**

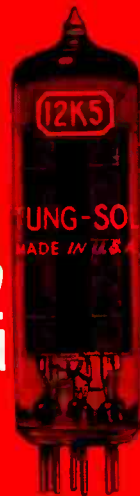

These four tubes, newly engineered by Tung-Sol, are the 12-volt tube complement for the first successful hybrid car radio. It is the Tung-Sol policy to offer engineering assistance impartially and to treat all information received in strictest confidence. Tung-Sol does not manufacture radios or television sets.



**TUNG-SOL**<sup>®</sup>  
**ELECTRON TUBES**  
**SEMICONDUCTORS**

**TUNG-SOL ELECTRIC INC., NEWARK 4, N. J.** Sales Offices: Atlanta, Ga., Columbus, Ohio, Culver City, Calif., Dallas, Tex., Denver, Colo., Detroit, Mich., Irvington, N. J., Melrose Park, Ill., Newark, N. J., Seattle, Wash.



MINIATURE LAMPS



SEALED BEAM HEADLAMPS



SIGNAL FLASHERS



RADIO AND TV TUBES



ALUMINIZED PICTURE TUBES



SPECIAL PURPOSE TUBES



SEMICONDUCTORS



COLOR PICTURE TUBES

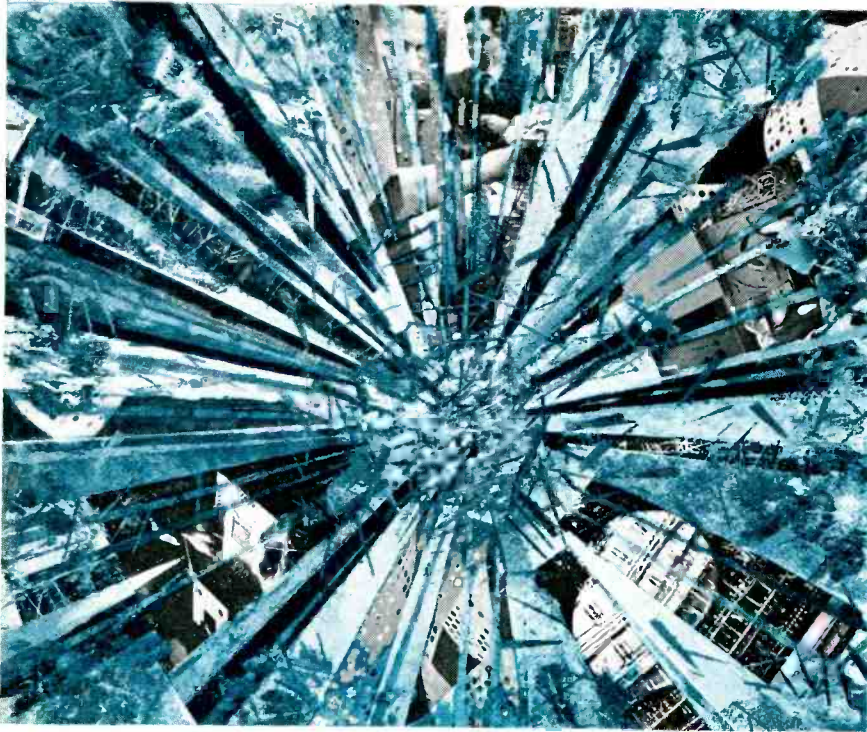

OPPORTUNITY IN SOUTHERN CALIFORNIA

stable, high-paying careers for

## CREATIVE DIGITAL COMPUTER ENGINEERS

experienced in advanced data-processing  
systems design

Here, in one of America's leading companies in the development of digital computers and electronic systems, you'll have full opportunity to make design contributions at the most advanced level. You'll enjoy the broad working freedom of a small, select research-design group and the vast technical resources of a parent company of international stature. The program is a continuing one with constant creative challenges. Because most activity is in development of equipment for worldwide commercial markets, stability is assured. Related projects are also undertaken for government and industry. New, ultra-modern, air-conditioned facility in a pleasant suburb of Los Angeles—the nation's fast-growing electronics capital. Broad benefits.



### Senior Mechanisms Engineer

Must be a strongly creative man with demonstrated ability in computer input-output devices.

### Senior Electronic Engineer

With experience in drum memories for digital computer systems. Excellent opportunity to form and head project in this work.

### Senior Computer Circuitry Engineer

With transistor experience in digital computer applications. Core circuitry experience desirable.

### Senior Mechanical Engineer

A key job requiring two or more years' mechanical design experience in high-speed digital magnetic tape handling units.

Excellent openings for engineers with experience in: logical design • ferroelectrics • magnetic cores • computer systems • transistor circuits • input-output devices • applications of physics • computer systems specifications • definition of system requirements.

For 16-page brochure describing activities and career potential at the NCR Electronics Division, write or contact D. P. Gillespie, Director of Industrial Relations

*National*\*

THE NATIONAL CASH REGISTER COMPANY  
Electronics Division

1401 East El Segundo Boulevard, Hawthorne, Calif.

\*Trademark Reg. U. S. Pat. Off.

pulse-forming network and pulse transformer of the line-type modulator. This package makes it possible to obtain the optimum required pulse shape, with a minimum of tedious development work or trial-and-error experimentation. Circle P19 inside back cover.



## PULSE FORMING NETWORKS in unlimited availability

AXEL ELECTRONICS DIV. AXEL BROS., INC., 134-20 Jamaica Ave., Jamaica, N. Y., has a complete line of capacitor pulse forming networks for industrial and military applications. All networks have an "E" circuit configuration, with equal, self-contained capacitor and coil sections. They are complete filled with highly-purified, low-loss dielectric, insuring against voids and consequent corona deterioration.

The pulse forming networks are available in the widest range and combination of electrical parameters. Charging voltages up to 50 kv, impedances between 5 and 500 ohms, pulse widths from 0.05  $\mu$ sec to several milliseconds, and repetition frequencies as high as 10,000 cps can be supplied.

Quality control standards meet or exceed all applicable military or commercial specifications. Circle P20 inside back cover.

## DRY BATTERIES for transistor radios

RAY-O-VAC, 212 East Washington Ave., Madison 10, Wisc. Models 1603 and 1604 are 9-volt A bat-

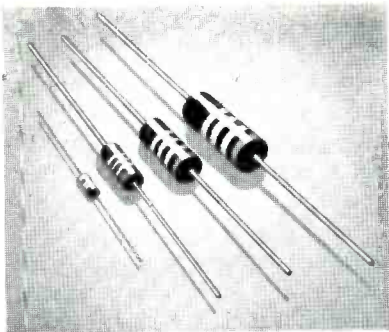

FIXED MOLDED RESISTORS—In 1/10, 1/2, 1, and 2 watt ratings at 70C ambient. Available in standard RETMA values.



The Allen-Bradley type of packaging prevents leads from tangling or bending.

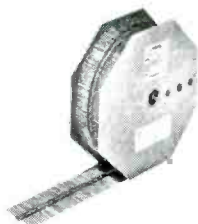

Reel packaging on pressure sensitive tape for automatic assembly lines.

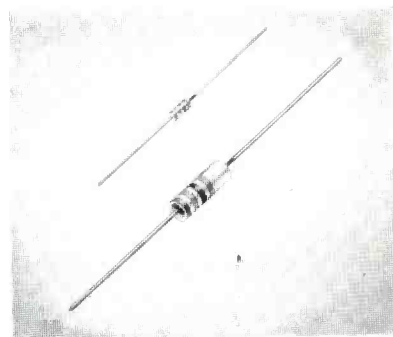

HERMETICALLY SEALED RESISTORS—Composition resistors sealed in a ceramic tube. 1/8 And 1 watt, 10 ohms to 500,000 megohms.

## WHERE ELECTRONIC RELIABILITY IS A "MUST" ... STANDARDIZE ON THESE ALLEN-BRADLEY COMPONENTS

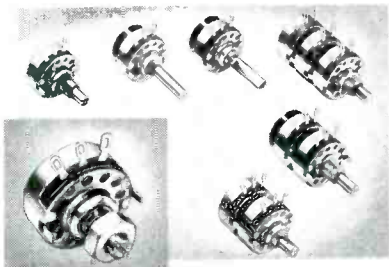

**VARIABLE RESISTORS—**Type J molded resistors, rated at 2 watts at 70C ambient. Total resistance values from 50 ohms to 5 megohms. Outstanding for low noise characteristics. Taps can be provided at 40, 53, and 68% of effective rotation. Metal parts are corrosion-resistant. Have solid molded resistor element.

**COPPER-CLAD FIXED RESISTORS—**Type GM rated at 3 watts at 70C and 4 watts at 40C. Type HM rated at 4 watts at 70C and 5 watts at 40C. Mounted in heavy copper clamps. Must be mounted on steel panel to radiate heat. Will not open circuit or exhibit erratic changes in resistance. Send for Bulletin 5002.

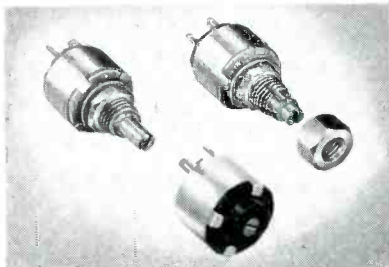
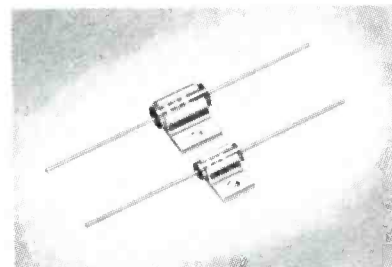

**VARIABLE RESISTORS—**Types G and F molded resistors are 1/2 inch in diameter. Total resistance from 100 ohms to 5 megohms. Ideal for use in printed circuits. The Type G all metal variable control is rated 1/2 watt; Type F control with molded end is rated 1/4 watt. Standard tapers.

**CERAMIC CAPACITORS—**Available in nominal capacitance values from 10 mmfd to .022 mfd in continuous d-c voltage ratings of 500, 1000, 2500, and 5000 volts. Also available in ceramic enclosures for greater mechanical strength and higher insulation dielectric strength. Operate up to 150C ambient temp.

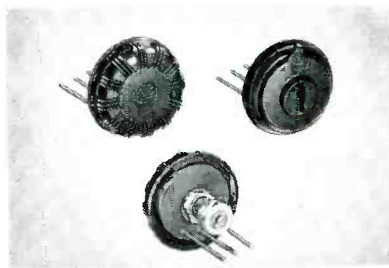
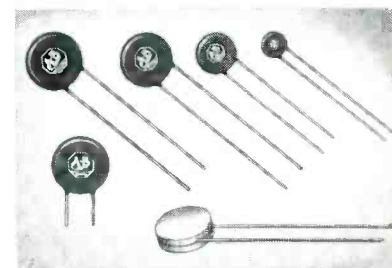

**VARIABLE RESISTORS—**Type T solid molded resistors for rheostat and potentiometer applications. The molded plastic actuator serves also as the cover which makes this unit extremely flat and compact. Rated at 1/2 watt at 70C ambient. Available in maximum resistance values from 100 ohms up to 5 megohms.

**FEED-THRU & STAND-OFF CAPACITORS—**These rugged capacitors exhibit no parallel resonance effects normally encountered with tubular capacitors in the VHF and UHF frequency ranges. Available in standard nominal values from 4.7 mmf to 1000 mmf with solder tabs or with screw-thread mountings.

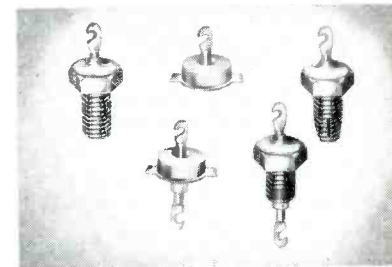

**INDUSTRIAL POTENTIOMETERS—**Type H rated at 5 watts at 40C ambient. Resistance range 50 ohms to 2 megohms. Good for 100,000 cycles with less than 10% resistance change. Derate to zero at 120C. Maximum voltage 750 v, d-c. After 100 hrs. at 40C and 98% humidity, resistance change not more than 5%.

**FERRITE CORES—**In various shapes and sizes to fit needs of black and white, color television and general applications. There are U and L cores for color convergence and O cores for color convergence shields; also U and E cores for flyback transformers, and QR cores for deflection yokes. Many other shapes available.

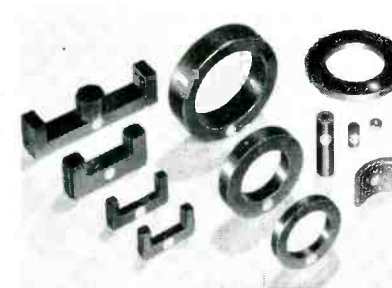

  
**ALLEN-BRADLEY**  
 RADIO & TELEVISION COMPONENTS  
 QUALITY

Allen-Bradley Co.  
110 W. Greenfield Ave., Milwaukee 4, Wis.

Please send me technical data on \_\_\_\_\_

Name \_\_\_\_\_

Address \_\_\_\_\_

City \_\_\_\_\_ State \_\_\_\_\_

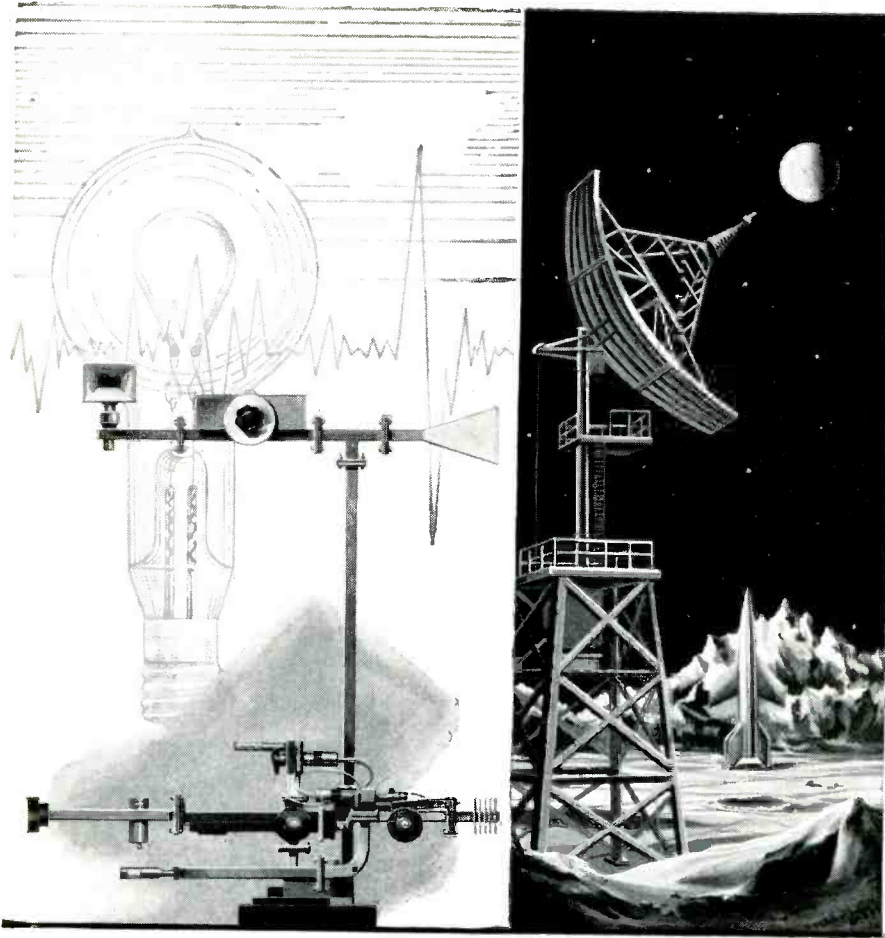

ONE OF A SERIES — depicting electronics — "Yesterday, Today and Tomorrow"

## spanning the spectrum

It's a big step from Edison's light bulb to DeForest's "audion" . . . a shorter step from the "audion" to the klystron tube. In bridging the gaps, scientific frontiersmen have founded a new industry. The growing applications of electronics are creating a fantastic industrial revolution. These developments are not only changing the weapons concept, but also the very basis of our civilization.

Bell Aircraft is a leader in electronics among the aircraft industries. Its achievements *span the spectrum* in the electromagnetic field. Intricate missile guidance systems, remote-controlled aircraft, landing systems for aircraft, and the recovery system used in several missiles are among Bell's notable advances.

To the engineer desiring top assignments . . . assignments requiring creative thinking . . . Bell offers an unparalleled opportunity for professional achievement. New contracts on missiles and other projects have created openings in our electronics staff for progressive minds seeking advancement. For the engineer with a B.S. or advanced degree interested in scientific frontiers contact . . .

**ELECTRONIC ENGINEERS**    Manager Engineering Personnel Dept. J

**SERVO ENGINEERS**

**INSTRUMENTATION ENGINEERS**

**LABORATORY ENGINEERS**

**TEST EQUIPMENT DESIGN ENGINEERS**

**MISSILE SYSTEMS TEST ENGINEERS**

**P. O. Box 1**

**Buffalo 5, N. Y.**



teries and have been introduced to take care of the rapidly expanding demand created by the latest types of transistorized portable radios. The batteries can also be used in electronic instruments and other battery-operated devices requiring a power component of their characteristics.

Further information on the firm's line of batteries for transistor radios is available from the company. **Circle P21 inside back cover.**



### PRECISION POT in 1-piece aluminum cup

HELIPOT CORP., Newport Beach, Calif., has introduced the series 5300 precision potentiometer. Measuring  $1\frac{1}{4}$  in. in diameter, the 2-oz. bushing-mount unit improves upon and will eventually replace the manufacturer's series G.

► **Additional Data**—It is housed in an accurately drawn one-piece aluminum cup. The unit is compact, extra rugged and long-lived. It also offers considerable improvement in mechanical runout, noise and torque. Up to 9 taps can be added during manufacture—each spot welded to a single turn of resistance wire, without shorting out adjacent turns.

Standard range of resistance goes from 25 to 49,000 ohms, with a best practical linearity tolerance of  $\pm 0.25$  percent above 2,000 ohms. Power rating is 2.8 w at 25 C ambient, 2 w at 40 C ambient. Operating range is from  $-55$  to  $+80$  C. Mechanical rotation is 360 deg continuous while electrical rota-

CHECK THESE



OUTSTANDING FORMICA LAMINATED PLASTICS . . .

*for your electronic applications*

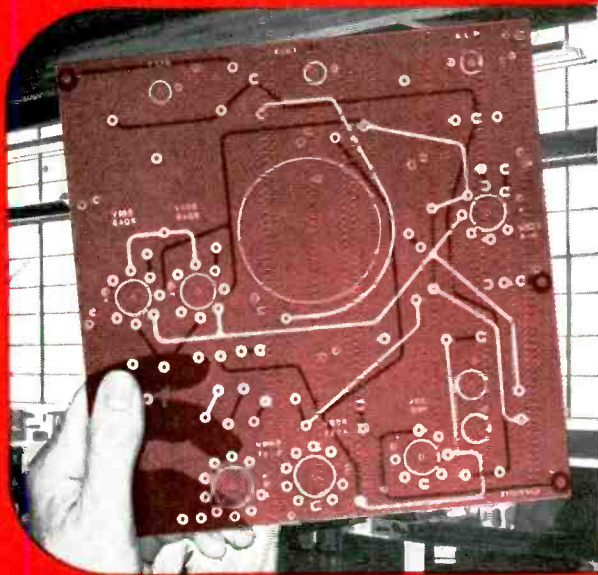

**1** New translucent Formica XXXP-36 offers cold punching and high IR

XXXP-36—new paper base phenolic grade—brings 1,000,000 megohms resistance value, precision and translucency to printed circuitry!

The new XXXP-36 sheet punches cold up to and including 1/16". Therefore, it is not subject to dimensional change as in grades which must be heated before punching. This means that with Formica XXXP-36, you can now produce circuits with new and higher standards of accuracy.

Also recommended for terminal boards, tv insulators and other applications requiring high IR. Send for bulletin 599.

**2**

**new  
glass  
silicone**



New G-7-2 offers greater hot strength, lower moisture absorption, lower wet power factor. Comes in larger sheets (up to 36" x 72" x 2"), and has a uniform creamy white color. Send today for free data sheets.

**3**

**FF-91  
glass  
epoxy**

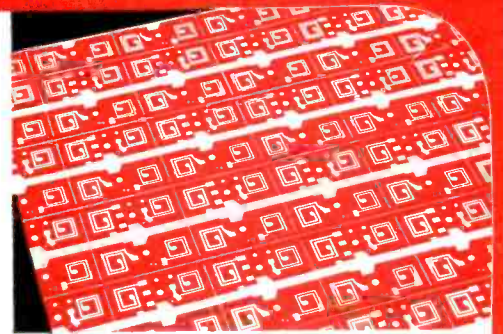

FF-91 is a super-insulator, has high operating and solder temperature and better bond strength. Especially valuable in hot, humid conditions, since its inorganic base resists fungus attack. Also has very high mechanical strength and cold punching characteristics. Send today for free data sheets.

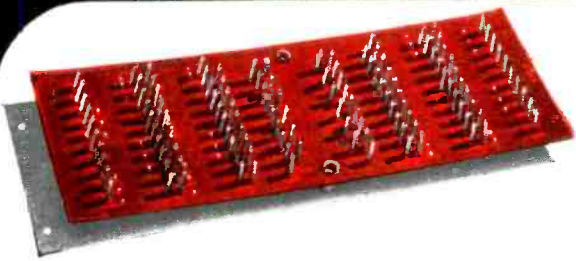

**plus special Terminal Board grades**

Terminal boards made of Formica offer electrical insulation, plus heat-, flame- and arc-resistance . . . and dimensional stability under extremes of temperature and atmospheric conditions.

**Write for detailed information**

Data sheets and bulletins giving complete information are available. Please indicate the grades in which you are interested:

- |  |   |
|--|---|
| Data sheet, grade XXXP-36 <input type="checkbox"/> | XXXP-36 bulletin 599 <input type="checkbox"/>         |
| Data sheet, grade G-7-2 <input type="checkbox"/>   | General catalog bulletin 627 <input type="checkbox"/> |
| Data sheet, grade FF-91 <input type="checkbox"/>   | Copper clad bulletin 688 <input type="checkbox"/>     |

FI-1224A

**FORMICA CORPORATION**

Subsidiary of American Cyanamid

7-4640 Spring Grove Ave.,  
Cincinnati 32, Ohio



**COMPACT!  
PRECISE!**  
*Hycon's* **NEW RACK MOUNTED  
OSCILLOSCOPE**



**Conserve vertical space—  
mount back-to-back for  
additional test positions**

Hycon Model 627R Rack Mounted 3" scope is a miniature unit in size only! With tight tolerance characteristics, it out-performs larger instruments of comparable rating. This perfectly balanced DC scope responds flat from DC to 150 kc, and is down less than 3 db at 300 kc. Sweeps 2 cps to 30 kc, lower rates with external capacitors. Sensitivity 10 mv rms per inch. Horizontal and vertical amplifiers are identical and balanced. The 3" CRT has tight tolerance, flat face with recurrent or triggered sweep... expands 8x tube diameter.

The compact 627R is one of the most practical scopes ever offered. Size and accuracy especially recommend it for industrial testing.

5 1/4" high  
•  
11" deep  
•  
for Standard  
19"  
Relay Rack



Rack Mounted Digital VTVM—only 5 1/4" high. Model 615R has a broad range of testing applications. Highly accurate and easy to read. 3-digit display reduces interpolation and parallax errors. For visual readout or printout applications.

*"Where Accuracy Counts"*  
**Hycon ELECTRONICS, INC.**  
Pasadena, California

*A Subsidiary of  
Hycon Mfg. Company*

**Send  
TODAY  
for latest  
catalogs!**

HYCON ELECTRONICS, INC., Dept. G10  
P. O. Bin D, Pasadena, California  
Pasadena, California  
Send the latest catalogs on Models 627R and 615R.

Name \_\_\_\_\_  
Address \_\_\_\_\_  
City \_\_\_\_\_ State \_\_\_\_\_

NEW PRODUCTS

(continued)

tion is 352 deg  $\pm$ 2 deg. Circle P22 inside back cover.

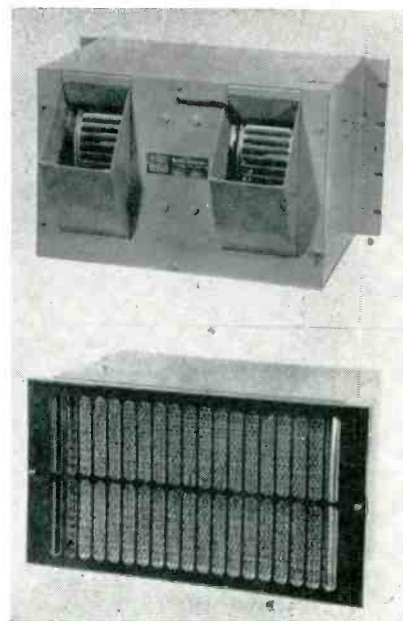

**COOLING FAN**  
for electronic cabinets

McLEAN ENGINEERING LABORATORIES, P. O. BOX 228, Princeton, N. J., is producing the model 2E610 electronic cabinet cooling fan designed for mounting on a standard 19-in. wide rack with a 10 1/2-in. panel height.

The 2E610 is a twin 6 1/2-in. centrifugal blower with each wheel double inlet, resulting in high air delivery and adequate motor cooling. It is equipped with a 1/2-hp double shaft motor and produces 800 cfm under normal operating conditions. It is equipped with permanent air filter and 19 by 10 1/2 stainless steel grill covering the entire front of the unit. Modifications are available to customer specifications. Circle P23 inside back cover.

**T-W TUBE**  
for S-band operation

BOMAC LABORATORIES, INC., Salem Road, Beverly, Mass. Amplification over a wide range of frequencies in the S-band region can be obtained by the use of the 6651/BL850 traveling-wave tube. Peak power output of 1 kw can be obtained with an accelerating voltage of 5,800. A magnetic field of 1,000 gauss is required to focus

# WESTINGHOUSE! IN BALTIMORE Rewards Ingenuity!



Coleman Miller receives check for \$5,000 from Gwilym A. Price, Westinghouse chairman and president.

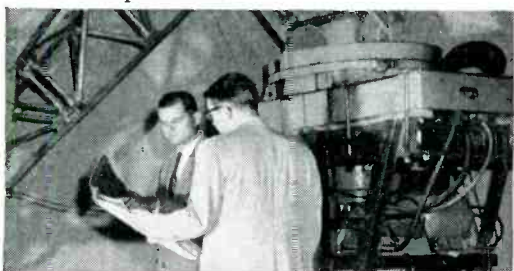

The award was for a lightweight, transportable radar antenna invented by Mr. Miller.

## Coleman Miller—A Career Engineer— Wins \$8,000 in Awards... At Electronics Division

A career engineer can cash in on his creativity at Westinghouse in Baltimore. Coleman J. Miller, an advisory engineer, has already received checks for \$5,000 and \$3,000 in patent awards from the company.

**BROAD EXPERIENCE LEADS TO PROMOTIONS**—Mr. Miller, like his fellow Westinghouse engineers, has worked on a wide range of projects. He has worked as design engineer on radar, microwave plumbing, antenna, transmitter and monitor equipment. He was made a supervisory engineer in 1952 and advisory engineer in 1955.

**OPPORTUNITIES FOR YOU AT WESTINGHOUSE**—The opportunities, facilities, and challenging projects that made Coleman Miller's success story possible are still available to you! The rapid expansion now under way at Westinghouse in Baltimore offer you exciting career possibilities. Investigate, and you too may decide on Westinghouse as the place to build your career.

### BALTIMORE OPENINGS

CIRCUITRY  
MICROWAVES  
SERVOMECHANISMS  
MAGNETIC AMPLIFIERS  
DIGITAL COMPUTER  
DESIGN & APPLICATION  
FIRE CONTROL SYSTEMS  
OPTICS  
COMMUNICATIONS  
PACKAGING

TRANSFORMERS  
ANALOG COMPUTER  
DESIGN  
VIBRATION  
RADAR DESIGN  
FIELD ENGINEERING  
INFRARED TECHNIQUES  
ANTENNAS  
TECHNICAL WRITING  
TEST EQUIPMENT

This  
Illustrated  
Brochure  
sent to  
All  
Applicants



### TO APPLY:

For a confidential interview send a resume of your education and experience to:

Dr. J. A. Medwin, Dept. 449  
Westinghouse Electric Corporation  
P.O. Box 746 • Baltimore, Maryland

Decide on

BALTIMORE **WESTINGHOUSE** DIVISIONS

WHERE BIG THINGS ARE HAPPENING IN  
**ENGINEERING CAREERS**

# GENERAL ELECTRIC — Pioneer In Engineering Achievements

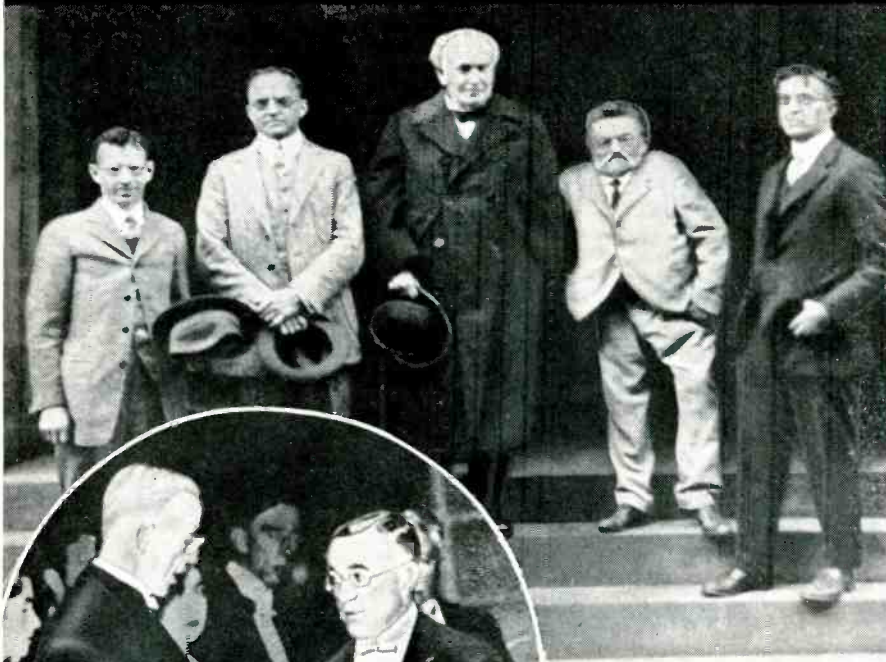

*Dr. Irving Langmuir is shown above receiving the Nobel Award from Gustavus V, King of Sweden in Stockholm in 1932.*

*The Contributions These General Electric Scientists Made To Our Present Civilization are Immeasurable. Left to right: Dr. W. D. Coolidge, Dr. W. R. Whitney, Thomas A. Edison, Dr. Charles P. Steinmetz and Dr. Irving Langmuir*

Dr. Irving Langmuir made many important contributions to the development and effectiveness of the incandescent lamp.

For example, one of Dr. Langmuir's projects was the study of the rate of evaporation from filaments at different temperatures, both in vacuum and in inert gases at different temperatures. Could a lamp be so designed that the increased loss of heat through the gas would

not wholly offset the increase of radiant efficiency made possible by the effect of the gas, in reducing the rate of evaporation, and so permitting the burning of the filament at higher temperature and higher brilliance?

To answer that question Dr. Langmuir made a thorough study of the loss of heat from small wires in gas. He discovered that lamps having large enough filaments would be more efficient, for a given life, if they contained nitrogen at atmospheric pressure instead of vacuum. He next perceived that if a filament were coiled in a closed helix, the diameter of the helix, not that of the filament, would be the determining factor in the loss of heat, so that in this way he could obtain high efficiency with smaller filaments, that is, in lower-wattage lamps. These were the first to be called Mazda C.

Wouldn't you, too, like to direct your Engineering career toward one filled with drama and accomplishment? The Aircraft Gas Turbine Division of General Electric offers Engineering Specialties in Rockets, Jet Engines or Controls and Accessories. Find out why so many hundreds of men say with pride, "I'm a General Electric Engineer." Address your correspondence to Mr. Mark Peters.

*Progress Is Our Most Important Product*

# GENERAL ELECTRIC

Technical Personnel Dept. 1B  
Building 100—Evendale, Cincinnati 15, Ohio

NEW PRODUCTS

(continued)



the electron beam. Driving power needed is approximately 1 w. Average power output without forced air cooling is 1 w.

The tube is mounted in a metal capsule which supports the tube in the focusing solenoid and also houses the input and output matching cavities. Weight of the tube and capsule is 5 lb, and the tube is 17 in. long and 1 7/8 in. in diameter. Circle P24 inside back cover.

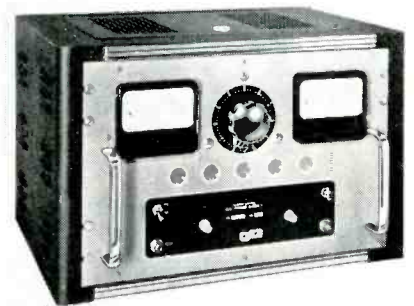

## D-C POWER SUPPLY dual range type

OPAD ELECTRIC Co., 69 Murray St., New York 7, N. Y. Model KM95B is a dual range d-c power supply with a continuous duty rating of either 0-32 v d-c at 40 amperes, or 0-64 v d-c at 20 amperes. Ripple is held to within 1 percent of the average d-c at maximum output. The unit operates on either 115 v or 230 v a-c 60 cycles single phase.

► Controls—All controls are conveniently arranged on the front panel and include a power switch, pilot light, 4 1/2 in. d-c voltmeter and ammeter, voltage control knob, output range selector switch, indicating type fuse holders, overload warning light and line voltage selector switch.

The equipment is self-contained in a steel cabinet 22 in. long by



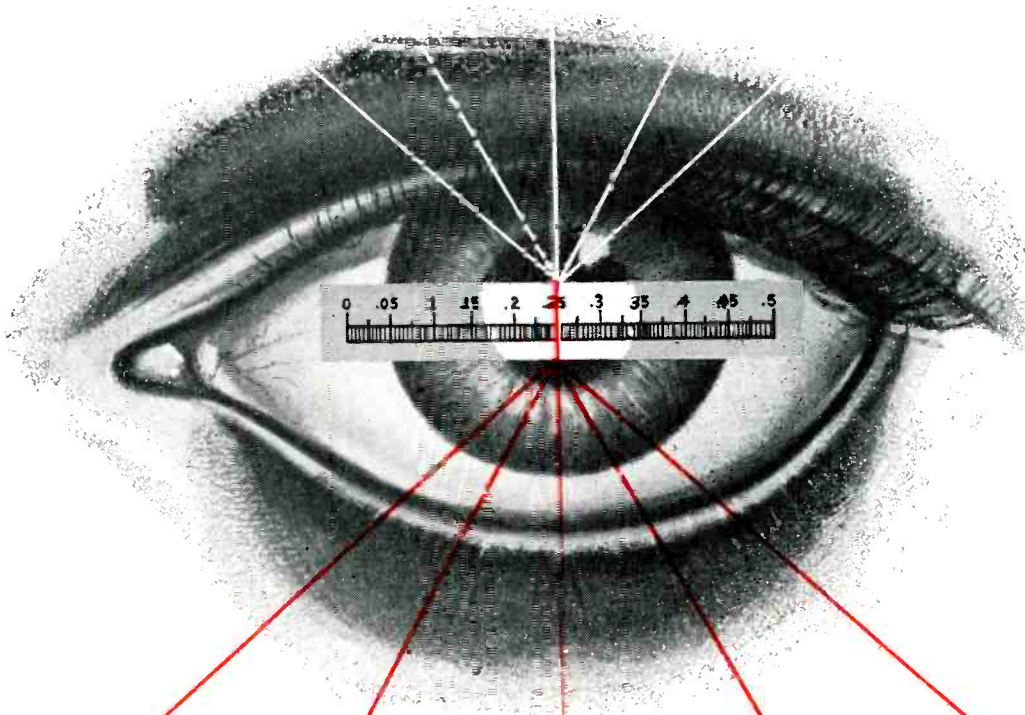

## look at it from any angle

### ERRORLESS READINGS WITH GREIBACH METERS

By a unique optical system of reflected light, scale positions on Greibach meters are shown by a light beam pointer with hair line indicator. Parallax is eliminated and readings can be made instantly from any angle with absolute precision. And no matter how you look at it, Greibach meters are versatile and rugged enough for any application. The low internal voltage drop of Greibach ammeters, for example, makes them perfect for transistor and other low energy applications.

Their ruggedness — they never need recalibration in normal use — and resistance to up to 500 g's shock allow rough handling without damage or loss of accuracy in factory or field use. For laboratory work too, Greibach meters provide such important features as full scale sensitivity to 1/2 microampere, up to 0.25% accuracy, and resistance to overloads up to 100,000%.

The edgewise panel meter shown here is the latest in a complete line of standard, portable, panel, and differential units for current, voltage, and resistance measurements. It can be conveniently stacked in layers for bench work, adapted for portable use, or readily incorporated in any console equipment.

If your project calls for a meter you'll do better with a Greibach meter. And if you have a technical problem that needs outside assistance, it's immediately available from our field representative without obligation.

# GREIBACH



INSTRUMENTS CORPORATION  
associated with  
GULTON INDUSTRIES, INC.

Metuchen, New Jersey

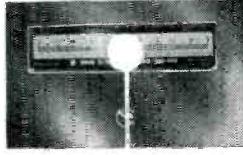
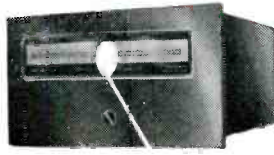

# IMC..... ahead in DYNAMOTORS

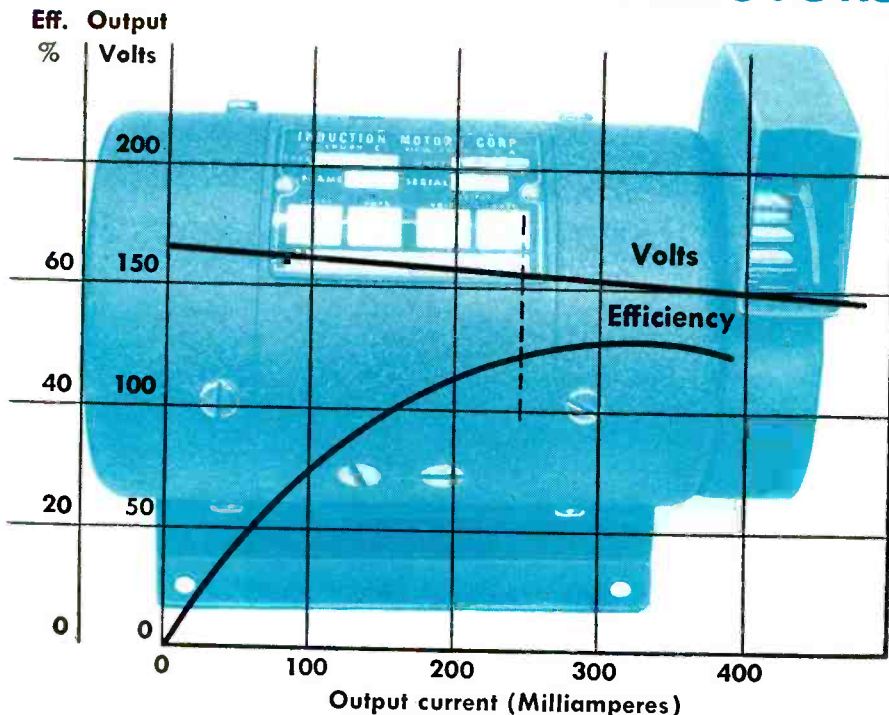

INDUCTION MOTORS CORP. is rapidly expanding its line of dynamotors for industrial and military use. In particular, IMC engineers have concentrated on development of dynamotors to meet the rugged shock and vibration requirements of the missiles field. The company's catalog now lists dynamotors with power outputs up to 110 watts, varying with duty cycle and ventilation. Input and output voltages are available to specification in standard frame sizes, any of which can be supplied with blowers for cooling applications.

## SPECIFICATIONS

### 3011 DYNAMOTOR (Shown with blower)

**Input:** 27.5 volts at 3.2 amps  
**Output:** 160 volts at 250 ma  
**Speed:** 9000 rpm  
**Weight:** 3 1/8 lbs.  
**Ripple:** Less than 1%  
**Ambient temperature range:** -55° C to +105° C

Our engineers can assist you in solving troublesome, time-consuming motor problems. Experience in design and manufacture of AC and DC subfractional, servo and gear motors, fans, blowers and the dynamotors mentioned above can be profitably applied to your own special needs.



## Induction Motors Corp.

570 Main St., Westbury, L. I., N. Y. Phone EDgewood 4-7070

NEW PRODUCTS

(continued)

15 in. diameter by 14 in. high. The power supply is also available for rack mounting. Circle P25 inside back cover.

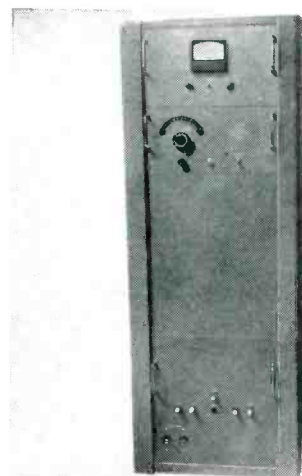

### A-C POWER SOURCES new Invertrons added

BEHLMAN ENGINEERING Co., 114 S. Hollywood Way, Burbank, Calif. New additions to the Invertron line of electronic a-c power sources are the 1.5 kva and 2 kva models, both featuring the accuracy, stability and regulation of previously available lower power units. The model shown has a power output of 1.5 kva three phase, with output frequency continuously variable from 350 to 450 cps. Ask for Catalog 56A. Circle P26 inside back cover.

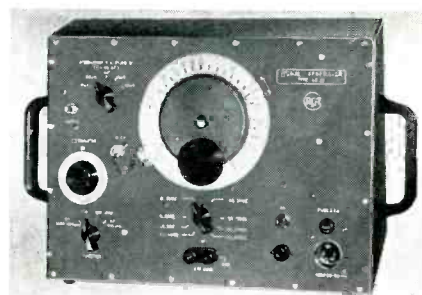

### SIGNAL GENERATOR offers 7 frequency ranges

RADIO CORP. OF AMERICA, Camden, N. J. Type LG-20 signal generator, a new lab and industrial test instrument, provides 7 frequency ranges and an i-f spread range, with coverage continuous from 42 kc to 50 mc.

The portable instrument pro-

*High Purity*

# Baker ELECTRONIC CHEMICALS

For your electronic tubes and screens—

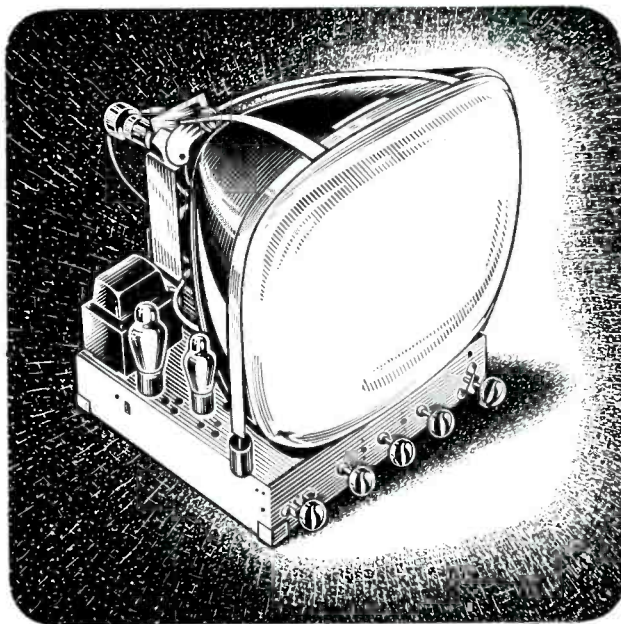

Acetic Acid  
Aluminum Nitrate  
Aluminum Sulfate  
Ammonium Carbonate  
Ammonium Chloride  
Ammonium Hydroxide  
Ammonium Phosphate  
Antimony Trioxide  
Barium Acetate  
Barium Carbonate  
Barium Fluoride  
Barium Nitrate  
Benzene  
Boric Acid  
Cadmium Chloride  
Cadmium Nitrate  
Cadmium Sulfate  
Calcium Carbonate  
Calcium Chloride  
Calcium Fluoride  
Calcium Nitrate  
Calcium Phosphate  
Ether, Petroleum  
Hydrochloric Acid  
Hydrofluoric Acid  
Lithium Carbonate  
Lithium Chloride  
Lithium Nitrate  
Lithium Sulfate  
Magnesium Carbonate  
Magnesium Chloride  
Magnesium Oxide  
Manganous Carbonate  
Methanol  
Nickelous Chloride  
Nickelous Nitrate  
Nickelous Sulfate  
Nitric Acid  
Potassium Dichromate  
Potassium Hydroxide  
Radio Mixtures  
Silicic Acid  
Sodium Carbonate  
Sodium Chloride  
Sodium Hydroxide  
Sodium Phosphate Dibasic  
Strontium Nitrate  
Sulfuric Acid  
Toluene  
Triple Carbonate  
Zinc Chloride  
Zinc Nitrate  
Zinc Oxide

**PURITY BY THE TON**  
*—for production use*

**BAKER CHEMICALS FOR THE ELECTRONIC INDUSTRY** are manufactured to rigid standards of chemical purity. They are ideally suited for the production of phosphors, emission coatings, activating agents, etc. used in military and civilian radar, radio and television equipment.

For many years, J. T. Baker Chemical Co. has supplied tonnage chemicals of controlled purity and uniformity for industries where precision is the key word.

Today, the increasing demands of high fidelity and color TV equipment present for ever-new challenges of closer tolerances. Baker works closely with chemists and electronic engineers to aid in meeting these challenges. You may be sure that Baker is well-equipped to supply your industry with the high purity tonnage chemicals you need—when you need them.

Look over the list of Baker electronic chemicals on this page—write Dept. R for prices and samples of those which interest you in your production. Further, if your development and research requires these or other chemicals to precise standards, Baker is your logical source of dependable supply.

**J. T. Baker Chemical Co.**  
REAGENT • CHEMICALS • FINE • INDUSTRIAL  
Phillipsburg, New Jersey

#### BRANCH OFFICES

NEW YORK  
122 E. 42nd St.

CHICAGO  
435 N. Michigan Ave.

PHILADELPHIA  
6908 Market St., Upper Darby, Pa.

LOS ANGELES  
170 E. California St., Pasadena 5, Cal.

# A new name for a proven instrument line...



DESIGNERS, developers and manufacturers of electro-mechanical instruments, *Humphrey Inc.* pioneered this vital field 10 years ago and has maintained its leadership role ever since, distributing on a license basis.

Now, expanded production facilities and expanded markets make it imperative for *Humphrey Inc.* to market its full line of instruments direct... under its own company name.

Better service... increased product line... continued research and development leadership... these will be the direct benefits to customers. The same high quality and performance standards for which these fine instruments have become recognized now will be available under the *Humphrey Inc.* label.



## ACCELEROMETERS

*Simple, rugged design. No pivots, bearings or loose springs. Pressure-sealed cases; potentiometer pickoffs.*



## RATE GYROS

*Light, compact, rugged. Good producibility, high natural frequency. Exclusive wheel and gimbal system.*



## POTENTIOMETERS

*Silicone-insulated metal cores. Teflon lead or high temperature connectors. Sealed, glass bead terminals.*



DEPT. E-10, 2805 CAÑON ST.,  
SAN DIEGO 6, CALIF.

*Send me your new Catalog as soon  
as it's off the press!*

NAME \_\_\_\_\_  
COMPANY \_\_\_\_\_  
ADDRESS \_\_\_\_\_  
CITY \_\_\_\_\_ STATE \_\_\_\_\_

vides either continuous wave or amplitude-modulated output, through a calibrated attenuator. Separate 1-v r-f output is incorporated for excitation of r-f bridges and similar applications. Circle P27 inside back cover.



## TELEMETERING FILTER

miniature in size

HYCOR, Division of International Resistance Co., 12970 Bradley Ave., Sylmar, Calif. A complete line of miniature telemetering filters for every channel and bandwidth is now being produced. A typical miniature band-pass filter (illustrated) in the MIL style GB case has 15-percent bandwidth at  $\pm 1.0$  db and phase shift linearity within  $\pm 5$  percent. Attenuation at  $\pm 15$  percent from center frequency is 30 db. Voltage gain is 0 db. These filters are hermetically sealed and designed for use between driving impedances and open grid. Circle P28 inside back cover.

## EQUIPMENT HEATERS

made of silicone rubber

Cox & Co., INC., 115 E. 23rd St., New York 10, N. Y. Thermolastic heaters, a new development of the company, bring new flexibility to the design of silicone rubber heaters, making possible improved performance for critical military equipment.

► **Highlights** — They incorporate the following features: any thickness down to 0.020 in.; any size

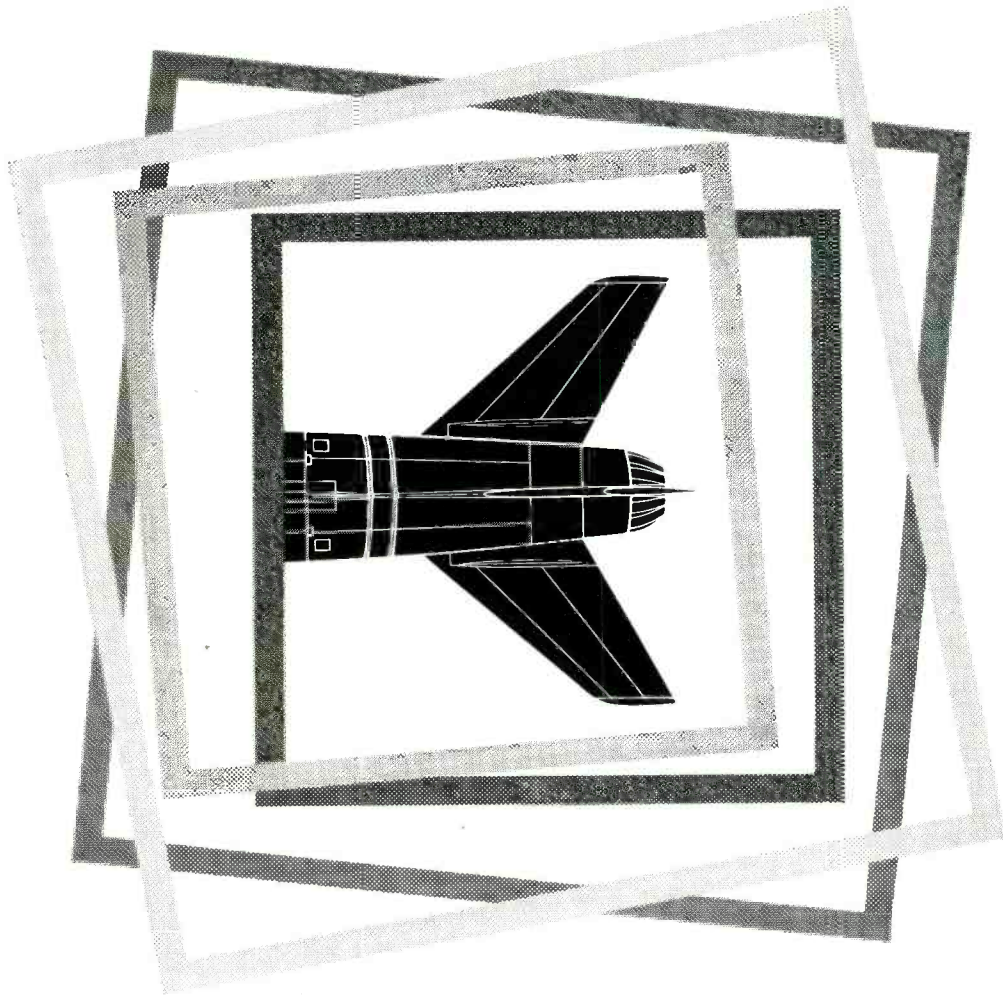

**NEW DEVELOPMENTS** in flutter, vibration,  
electronics, many other specialized fields:  
**EXCEPTIONAL OPPORTUNITIES NOW**

You can accelerate your own career considerably by working with us on some of the most advanced problems in the aviation industry—the problems of high performance aircraft, supersonic and hypersonic designs of the present and the future.

This high speed research includes design and test in Vibration, Aeroelastic and Flutter analyses, analog and digital computer techniques in Electronics, and many more.

The opportunities at North American, Los Angeles Division, are many and varied. You work surrounded by activities of a highly interesting nature, using facilities of the most advanced type. You'll enjoy wide scope for your talents, and you'll particularly like the climate of individualism and team spirit that exists. Your associates will be people who respect your opinions and professional status. Check the openings listed below.

**OPENINGS ARE IMMEDIATE. PROFESSIONALLY QUALIFIED WOMEN ARE WELCOME**

Recent Aeronautical Engineering Graduates • Recent Mathematics Graduates (Women) • M. E. Graduates with Vibration Experience • Recent Electrical Graduates, for Lab. work • Experienced Flutter Engineers (Aeronautical, Mechanical Engineers, Physicists, Mathematicians) • Experienced Vibrations Engineers • Experienced Instrumentation Engineers, electrical background • Experienced Analog or Digital Computer Engineers, either Electrical, Mechanical or Aeronautical Engineers, or Physicists. Heavy analog experience desirable.

**ALSO NEEDED:** Aerodynamicists, Systems Engineers, Instrumentation Engineers, Aero-Thermodynamicists, Aeroelastic Engineers, Cycle Analysis Engineers

**Contact Les Stevenson, Engineering Personnel Office, Dept. 56-10EL  
North American Aviation, Inc., Los Angeles 45, California**

North American Aviation, Inc. is doing research and development on the X-15, a manned aircraft for investigation of speeds and temperatures at very high altitudes.

Los Angeles Division

**NORTH AMERICAN AVIATION, INC.**

NORTH AMERICAN HAS BUILT MORE AIRPLANES THAN ANY OTHER COMPANY IN THE WORLD

ELECTRONICS — October, 1956



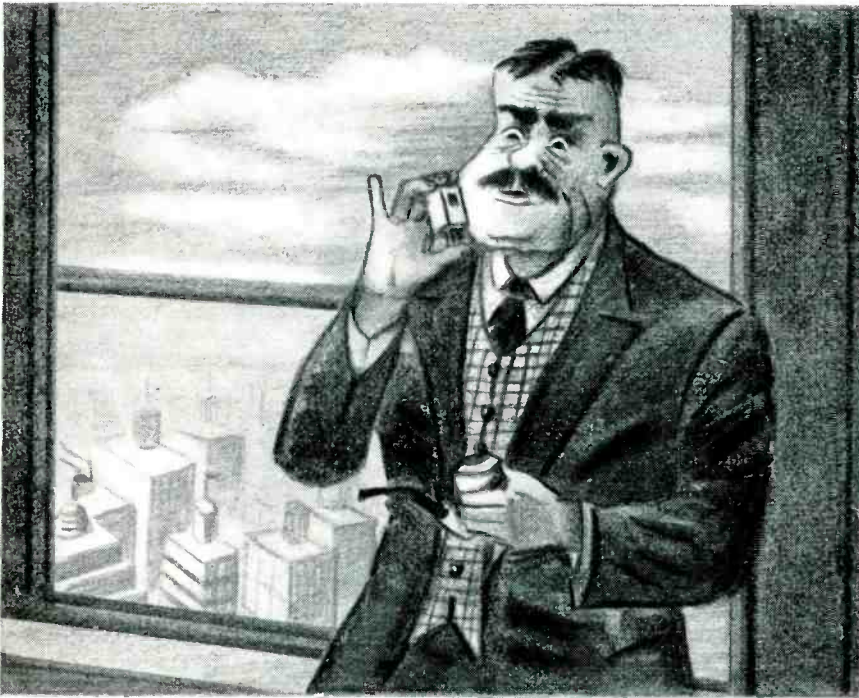

Mr. P. Argyle Wigglesby, Board Chairman of Conglomerated Figleaf Enterprises, seen examining new SIGMA CDS PHOTORELAY. Although almost speechless, Mr. W. did finally manage the comment, "This is just great!"

and right you are, Mr. Wigglesby!

Now that commercial development of cadmium sulfide photocells has settled down a little and production lots arrive accompanied only by the less troublesome types of bugs, it seems reasonable to think about the useful applications these cells may have. To help such thinking and thinkers, Sigma has put together a 41 relay and a CdS cell in a neat, manageable and low-cost package. The CdS Photorelay—Model 1, now in production, offers these specs:

- Operate: 5 foot-candles (max.); drop-out 0.1 f-c (min.)
- Speed: 2 operations per sec., guaranteed minimum
- Coil voltage: 115 AC
- Temperature range: -40° C. to +95° C.
- Mounting & enclosure: 5-pin base, dust-can cover.
- Price: \$12.00 each (quan. 1-19); \$7.20 each (1000 and up).

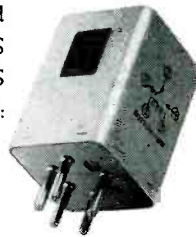

The Series 41 relay used in this device was hailed (by us) about a year ago as "probably the best, low cost AC relay available with sufficient sensitivity (0.10-0.15 v-a) for such use." To date we haven't seen any reason to alter our ego concerning the 41.

So far Photorelays have been shipped only in limited numbers to various interested manufacturers, but repeat orders seem to indicate we may really have something (or more accurately, they have something that needs the Photorelay).

\* Pinball machines

**SIGMA INSTRUMENTS, INC.**  
62 Pearl Street, So. Braintree, Boston 85, Mass.

Likely prospects include, in addition to Mr. Wigglesby, manufacturers of furnace flame-out controls, pinball machines\*, elevators, conveyors, weighing equipment, etc. The Photorelay has already been incorporated in automatic bottle washing and bagging equipment designs. (Special models are pending, awaiting further word from Conglomerated Figleaf.)

The easiest way to see how you might use such a compact, low-cost, AC photoelectric control in your equipment, is to buy a sample and try it.

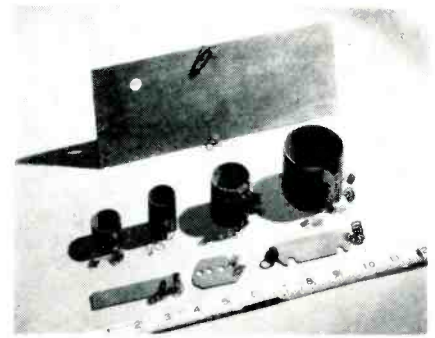

from ¼ sq in. to 10 sq ft; any flat cylindrical or conical shape; any desired cutouts; multiple circuits within a single heater; any desired heat dissipation pattern in any circuit; ratings up to 30 w per sq in. and higher; operation up to 230 C; dielectric strength of 2,000 v d-c or more; Teflon-insulated leads, securely anchored; and unlimited life.

Traditionally, silicone rubber heaters could only be cemented in place by tedious procedures involving the application of pressure and prolonged curing at high temperatures. Conventional adhesives would not stick to the silicone rubber surface. The new heaters discussed have entirely eliminated this difficulty. **Circle P29 inside back cover.**



**POWER RESISTORS**  
above-chassis plug-in type

CLAROSTAT MFG. CO., INC., Dover, N. H. The series KS or Standee above-chassis-mounted power resistors are now available with newly designed terminals featuring plug-in type installation. They are available in 5 sizes from 1½

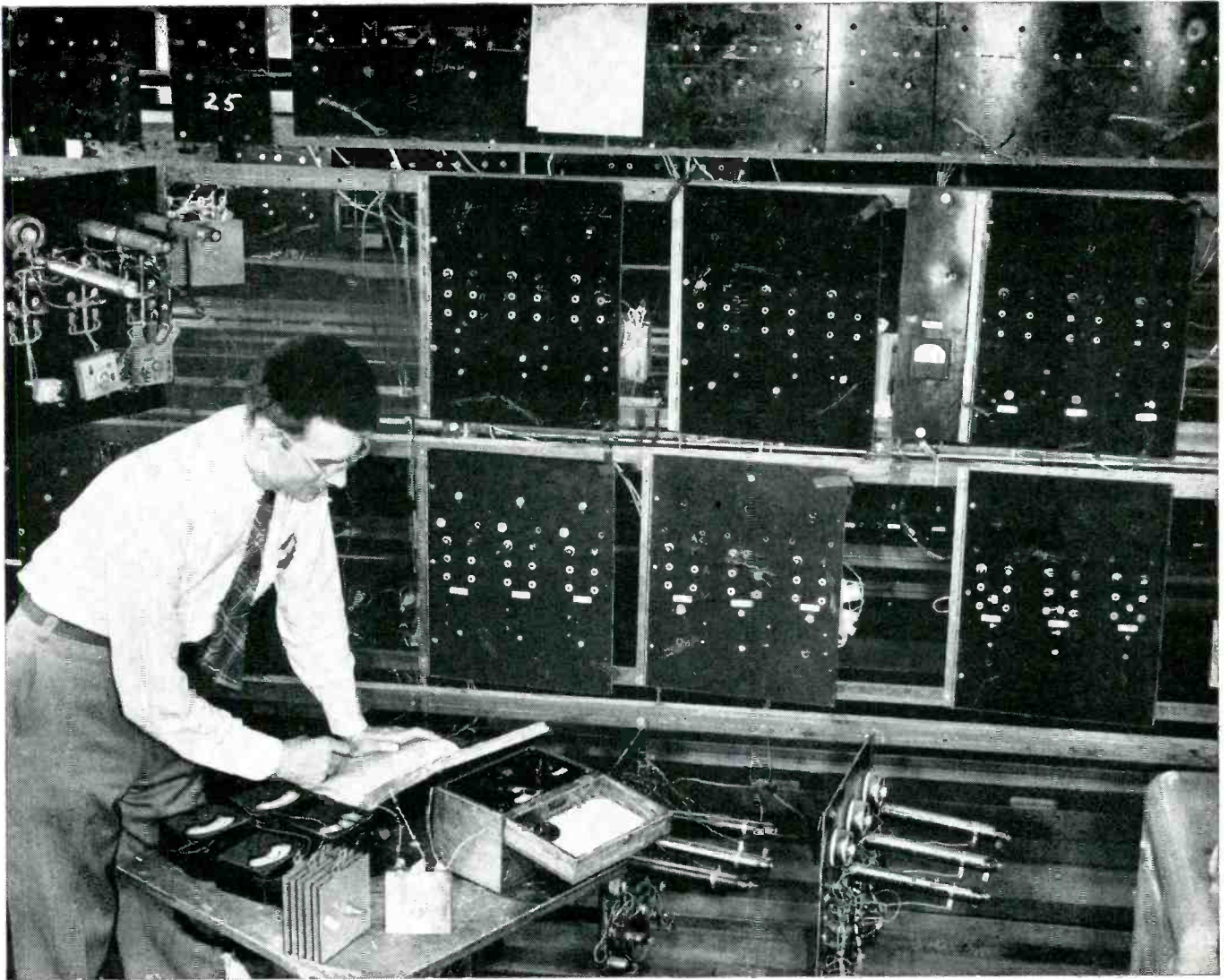

## Life tests of Westinghouse selenium stacks prove lowest forward aging rate in industry

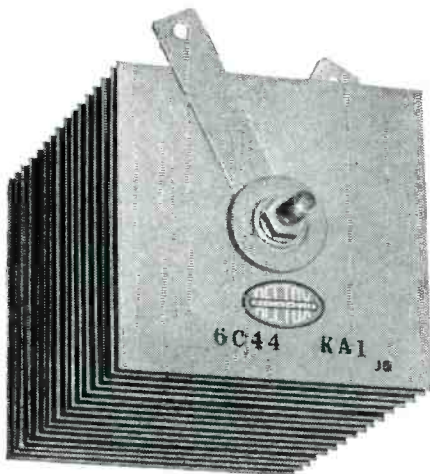

This is another way Westinghouse assures you of product reliability. Life tests are conducted at not less than 35°C ambient. The standard Westinghouse life test method is to operate the stacks continuously at 110% of rated voltage and current output. During the first two years of these tests, practically no increase in forward resistance has occurred. Some stacks have actually decreased in forward resistance during this period.

Such tests establish the quality of the product and the uniformity of cell production. They also prove the superiority of the Westinghouse evaporative process for applying selenium to the cells. This is your assurance of consistent performance for the life of the selenium stack.

For all the facts, call your Westinghouse sales engineer. He'll show you other reasons why it pays to specify Westinghouse selenium stacks.

J-21949

**WATCH WESTINGHOUSE!**

**WHERE BIG THINGS ARE HAPPENING TODAY!**

# HANDLES

- **SIX TYPES** and sizes to suit nearly every requirement. USECO's standard handles are made of half hard brass, nickel plated. Stainless steel handles available on special order. Other finishes include cadmium and black oxide. Supplied with or without ferrules. Furnished in 5/16" 18 thread. Available with or without nuts and washers. For Engineering Manual and complete information please address Dept. 16

See us at Booth #129 N.E.C. Hotel Sherman, Chicago

**ADJUSTABLE HANDLE** (illustrated at top)  
 —An all-purpose handle with adjustable center spacing from 4 inches to a maximum of 6 inches. (On special orders an unlimited maximum center spacing can be furnished.) Height above panel can vary from 1½ to 2 inches.

HANDLE	PART NO.	WIDTH	HEIGHT
HANDLE	1005	6.437	1.750
HANDLE	1007	6.000	1.500
HANDLE	1010	4.250	1.500
CABINET HANDLE	1115	3.000	1.500
ADJUSTABLE HANDLE	1025	4" to 6"	1.500
ECONOMY HANDLE	1030	3" plus; in 1/8" increments	1.437

## U. S. ENGINEERING CO., INC.

A Division of Litton Industries, Inc.

521 Commercial Street, Glendale 3, California

in. to 4½ in. high and in 10 to 30-w power ratings. Values of resistance are up to 21,000 ohms. Form No. 754304 gives further information. Circle P30 inside back cover.



### COAX POWER PAD requires no forced cooling

WEINSCHEL ENGINEERING, 10503 Metropolitan Ave., Kensington, Md. Model 528 coaxial power pad has 50-ohm impedance, type N connectors, and is used to extend the 10-mw frequency sensitivity range of commercial power meters to 30 w.

► **Features** — Power sensitivity (change of attenuation) is less than 0.1 db/10 w. Maximum input vswr under full rated power is 1.20. Maximum output vswr under power is 1.10. Typical frequency sensitivity (change of attenuation with frequency) is 0.3 db. Insertion loss is d-c to 600 mc.

No forced cooling is required. This is a 7-section tee-pad containing carefully aged film resistors resulting in an excellent long term stability. Circle P31 inside back cover.

### PRESET COUNTER has varied applications

ELECTRO-PULSE, INC., 11861 Teale St., Culver City, Calif. Featuring compactness, economy, long life and versatility, the model 7240A preset counter is usable in applications such as time interval generation and the control of sorting equipment, winding machines, counting and packaging, engine rpm, shearing and punching, and automatic feeds. It utilizes cold cathode glow transfer tubes which



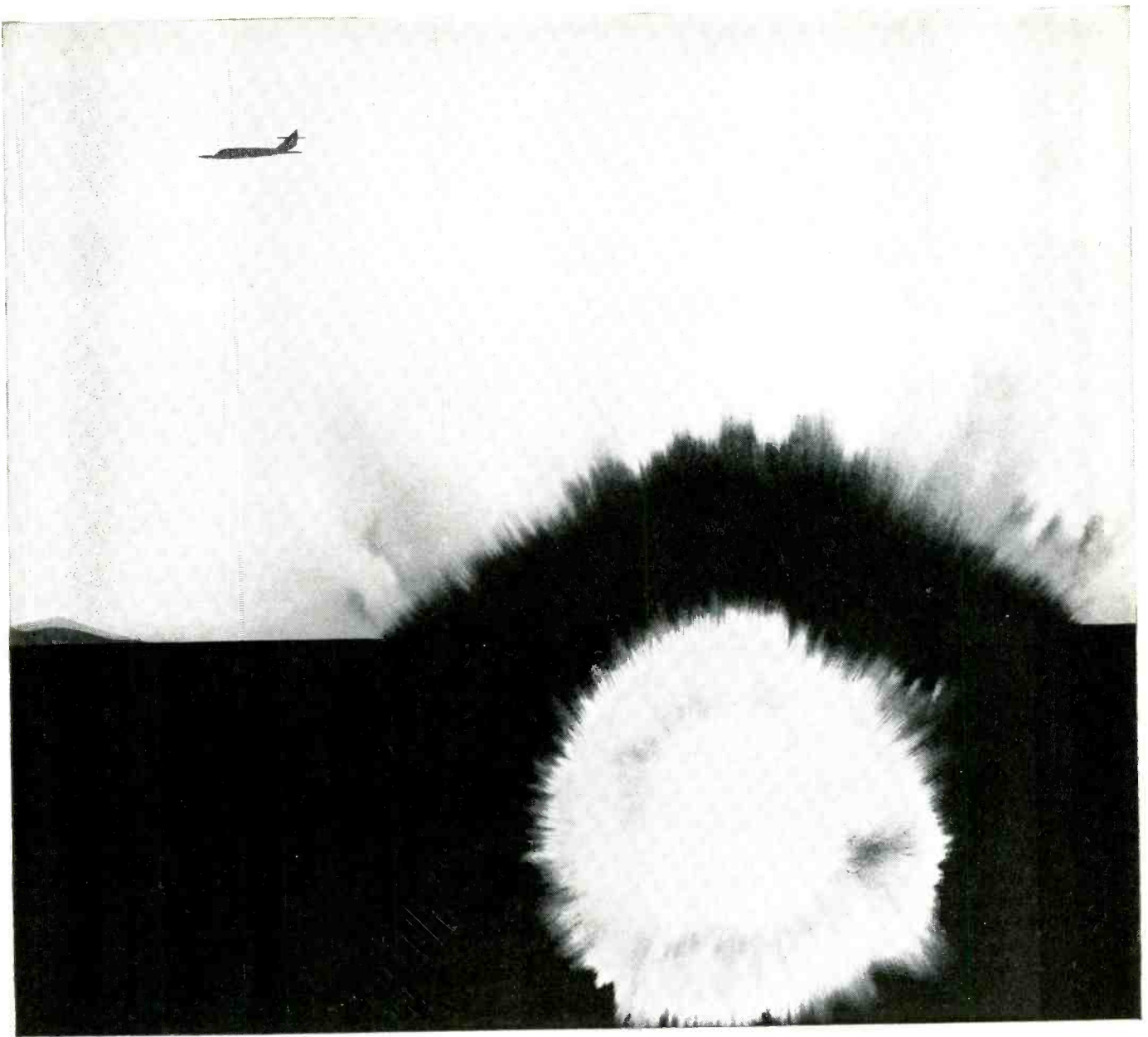

In underwater ordnance, too

## AMF has experience you can use

● From the development and production of complete underwater ordnance systems, both conventional and atomic—to the design and manufacture of underwater vessels to withstand crushing hydrostatic pressures at great depths—AMF is daily engaged in hundreds of complex engineering tasks. ● The highly specialized, yet widely diversified activities of some 35 engineering and production facilities provide AMF with a wealth of experience that covers nearly every field of industry. And it is immediately available to you. ● Call upon AMF with your problem. See for yourself why this all-around experience in answering the needs of government and industry alike has made AMF the “can do” company.

Research, Development,  
Production in these fields:

- Armament
- Ballistics
- Radar Antennae
- Guided Missile Support Equipment
- Auxiliary Power Supplies
- Control Systems



Defense Products Group

**AMERICAN MACHINE & FOUNDRY COMPANY**

1101 North Royal Street, Alexandria, Va.

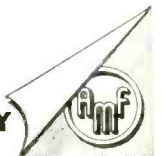

# HEY!

## ...know a good place to get EPOXYS?

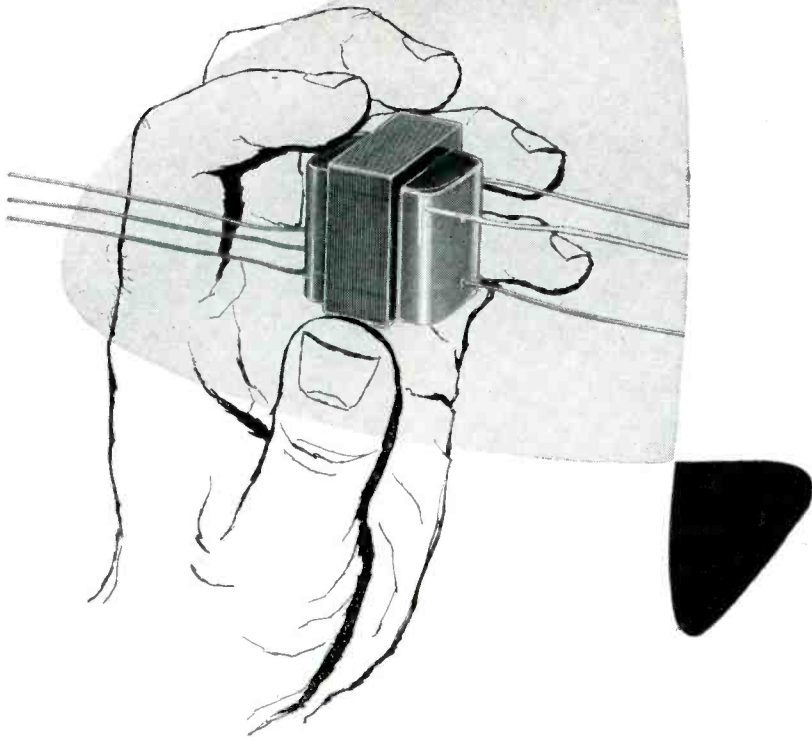

Wheeler's new epoxy resin cast electronic components...including inductors, transformers, and subminiature assemblies of tuned circuit elements... offer the following specific advantages:

- Extremely wide ambient and internal temperature tolerance.
- Exceptional mechanical and physical stability... freedom from cracking, deformation, chemical or physical changes, and deterioration under service conditions.
- Exceptional electrical properties without tendency to deteriorate.
- High resistance to humidity, chemicals and other contaminants.
- Flexible leads and/or terminals.
- Elimination of hermetically sealed cans.
- Elimination, in many cases, of mountings.
- Further steps in miniaturization.

Wheeler's equipment for the casting of epoxys complements already very complete engineering and production facilities in the field of custom transformers, coils, amplifiers and electronic assemblies for military and civilian service. Here is your logical source for both development assistance and experienced production.

**THE WHEELER**   
**INSULATED WIRE COMPANY, INC.**  
Division of Sperry Rand Corporation  
1101 EAST AURORA STREET • WATERBURY 20, CONNECTICUT

3WH56

358

NEW PRODUCTS

(continued)

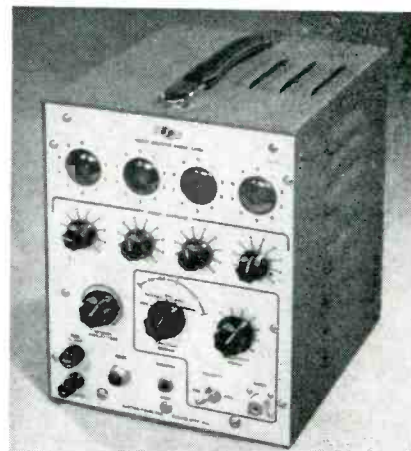

accomplish both counting and indication.

► **Operation**—The unit counts and indicates the number of input events up to a number (from 1 to 9,999) preset by four decade switches, at which time an output pulse is provided, a relay operates and the count is held. Rapid recycling or manual resetting to repeat the operation is provided.

The unit may be used as a time interval generator by counting the line voltage frequency, presenting the interval as a relay open or closed time. **Circle P32 inside back cover.**

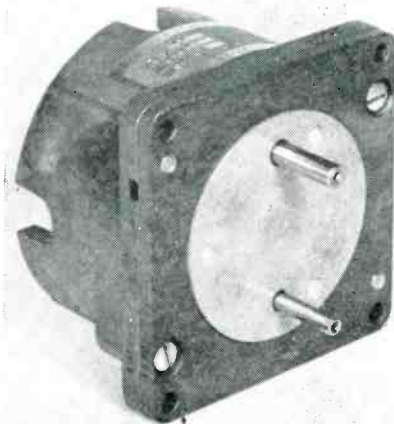

### GEAR BOX dual output type

LINK AVIATION, INC., Binghamton, N. Y. Available in a variety of ratio combinations, model 013 dual output gear box provides primary and secondary output shafts for use in servo systems where two constant ratio outputs are required. The unit with its second output minimizes space consum-

# what is available from Pyramid

A complete line of capacitors—electrolytics, paper and metallized paper for wired and printed circuit chassis . . . all made to standards which exceed even rigid military specifications. Full advertising and merchandising support.

Burton Browne / New York

## PAPER

 Type 85 LPT

Type CT 

 "IMP" Molded

 Type PG' Glasseeal, "CP04, DCP11

## OIL PAPER



Type PDM, CP53



Type PLMF, CP70



Type PTIM, CP25



Type PEM, CP67, CP69



Type PKM, CP61 to CP65

Type PJ, CP70



A new time saving, profit making capacitor resistor analyzer with incorporated quick check feature at low cost. Model CRA-2 now available. See your Pyramid representative.



THE BIG NAME IN CAPACITORS AND SELENIUM RECTIFIERS TODAY.

**PYRAMID** ELECTRIC CO.  
North Bergen, New Jersey



## PRINTED CIRCUIT CAPACITORS

Type BTS Autocaps 

 Microlytics



Type ATM Autolytics



Type ACD Autolytics

## METALLIZED PAPER

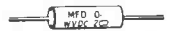

Type MT



Type MPD

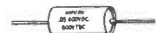

Type MPG



Type MPT

A full line of the first new design of selenium rectifiers in twenty years.

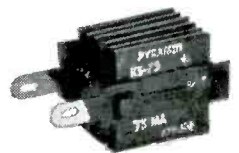
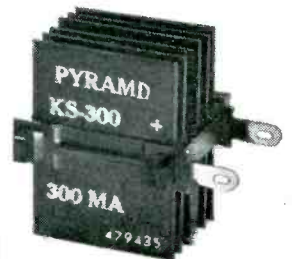

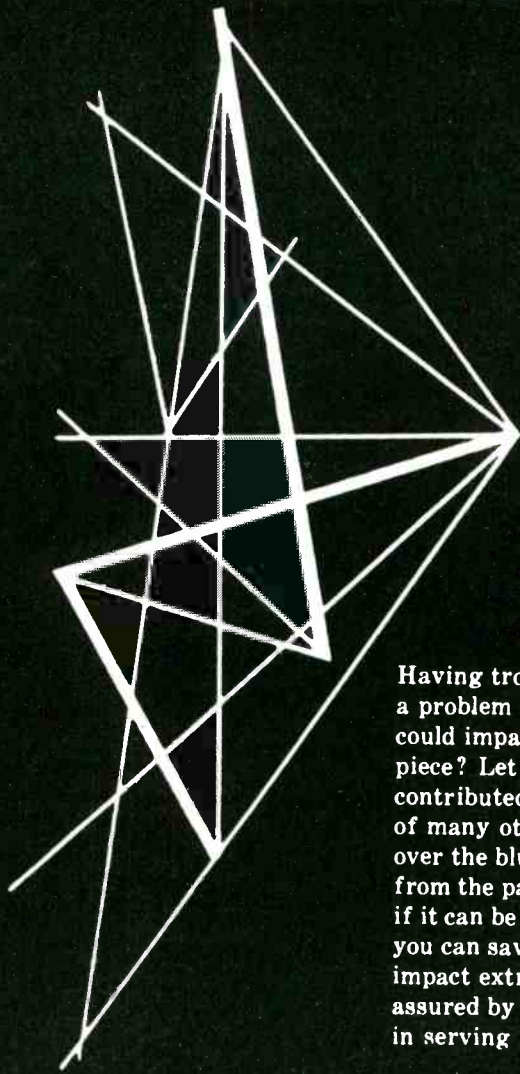

Having trouble finding a problem part? Wish you could impact extrude it in one piece? Let us help. We've contributed to the thinking of many other firms...taking over the blueprints or working from the part itself. Can tell if it can be done and how much you can save by one-piece impact extrusion. Promptness assured by 30 years reputation in serving big business.

**SunTube**  
CORPORATION

HILLSIDE, NEW JERSEY

IMPACT EXTRUSIONS · CONDENSER CANS-SHELLS  
ALUMINUM · ZINC · MAGNESIUM · LEAD · SILVER

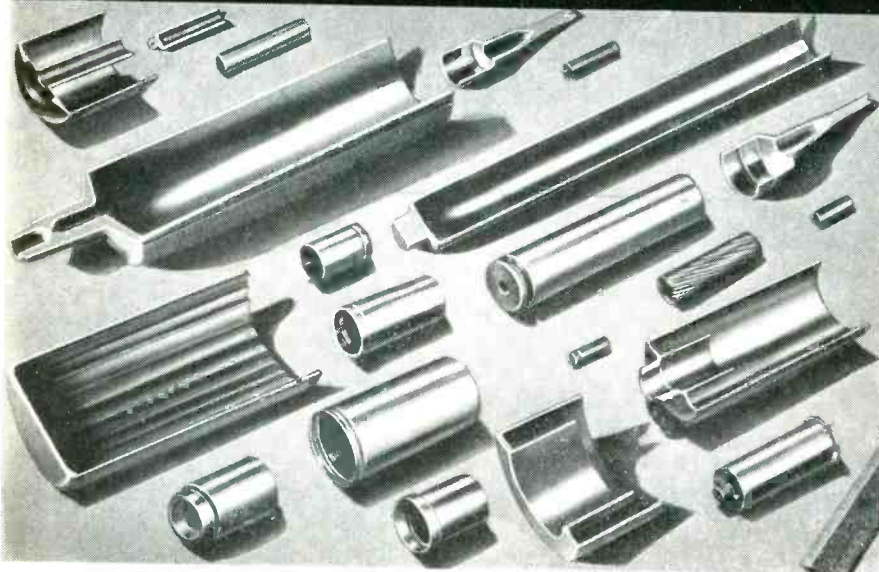

ing gear arrangements and in some instances completely eliminates a servo system which may otherwise be needed to provide the additional output.

The gear box is adaptable to scaling problems where two different operating speeds are required, or where one fast positioning speed and a slower speed are needed as in recorders. Adapter kits are available to facilitate utilization of the dual output gear box with various standard servo motors. Literature will be furnished upon request. **Circle P33 inside back cover.**

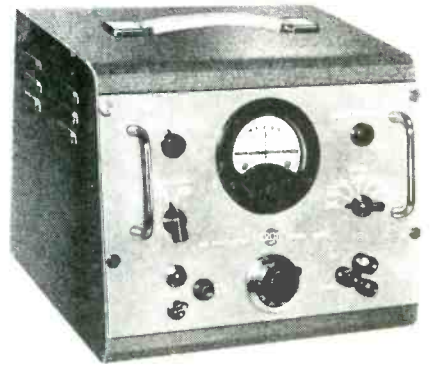

RADIO CORP. OF AMERICA, Camden, N. J. Type LV-14 d-c null voltmeter is a test instrument capable of d-c measurements over the range of 0 to 600 v d-c with accuracy of  $\pm 10 \mu\text{v}$ . Designed for a wide range of applications involving the test or calibration of numerous types of equipment, the LV-14 d-c voltmeter incorporates a highly stable power supply, standard cell for calibration, precision attenuator and sensitive null indicator.

The null indicator is a rugged  $3\frac{1}{2}$  in. zero-center panel meter, with sensitivity approximating  $1 \mu\text{a}$  per division. **Circle P34 inside back cover.**

#### MINIATURE MOTOR for telemetering uses

EL RAY MOTOR Co., INC., 11747 Vose St., N. Hollywood, Calif., has announced a new miniature motor featuring a governor controlled

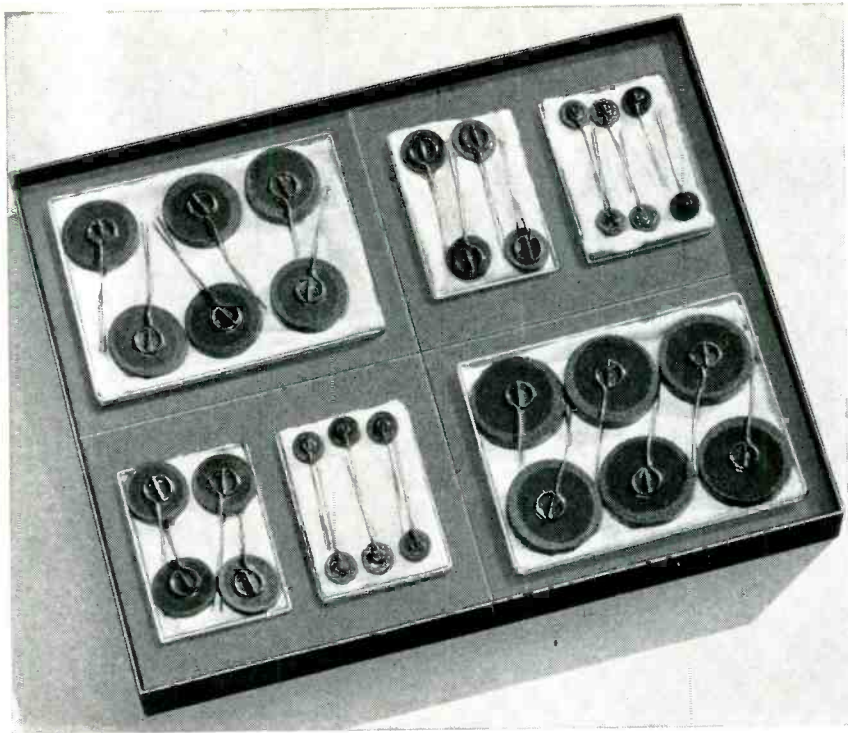

# NEW TEST KIT of GLOBAR®

Type BNR VARISTORS  
*for design and application work*

Quantity	Cat. No.	R @ Calibration Voltage	Load Watts
6	432	100000 @ 10 volts	0.25
6	479	100000 @ 100 volts	0.3
6	328	10000 @ 40 volts	0.5
6	463	24000 @ 40 volts	1.0
6	524	24000 @ 100 volts	1.5
6	430	17500 @ 175 volts	2.7

**KIT No. 3** Type BNR VARISTORS PRICE \$20.00  
*to evaluate use of GLOBAR® Type BNR Varistors for*

- Reduction of surge voltage peaks from 50% to 90%.
- Reduction of contact arcing time up to 95%.
- Reduction of R. F. radiation.
- Stabilizing amplifier gain.
- Stabilizing speed and voltage.
- Stabilizing of rectifier circuits by limiting peak voltages.

## OTHER TEST KITS

of GLOBAR® Ceramic Varistors and Thermistors now available to help you solve your circuitry problems include:

**KIT No. 1** PRICE \$29.25  
Type F THERMISTORS

- To evaluate series filament circuit application in radio and television receivers.

Quantity	Cat. No.	R @ 25 C	R @ Rated Current	B Constant	Load Watts
6	763	15		1500	0.5
6	441	880	100 ohms @ 150 ma	1900	2.7
6	341	375	40 ohms @ 300 ma	1950	3.6
6	525	250	20 ohms @ 600 ma	1900	7.2
6	327	460	35 ohms @ 600 ma	1900	12.6
6	421	125	43 ohms @ 600 ma	1100	16.5

**KIT No. 2** PRICE \$24.50  
Type H THERMISTORS

- To evaluate time delays in relay and solenoid circuits; temperature compensation in field coils and meters.

Quantity	Cat. No.	R @ 25 C	B Constant	Load Watts
6	416	1200	3200	0.7
6	479	1000	3800	1.85
6	373	10	2700	3.0
6	343	20	2700	3.0
6	549	5000	3200	1.5
6	588	11000	3200	2.0

**KIT No. 4** PRICE \$18.25  
Type F, Type BNR VARISTORS and THERMISTORS

- To evaluate stabilizing rectifier circuits by limiting peak voltages.

Quantity	Type BNR Cat. No.	R @ Calibration Voltage	Load Watts	
6	432	25000 @ 10 volts	0.25	
6	432	100000 @ 10 volts	0.25	
6	432	200000 @ 10 volts	0.25	
	Type F Cat. No.	R @ 25 C	B Constant	Load Watts
6	763	15	1500	0.50
6	763	120	1750	0.50
6	763	330000	2150	0.50

**EACH KIT CONTAINS** 36 resistors — 6 of each specified type, packaged in attractive transparent plastic boxes, plus an engineering bulletin. Kits will be shipped postpaid to any point in the United States and Canada. All resistance values specified carry standard production tolerance.

**ORDER YOUR KITS NOW...**

*use this Handy Coupon*

GLOBAR Division  
THE CARBORUNDUM COMPANY  
Dept. E 87-56, Niagara Falls, New York

Please ship kits as follows:

\_\_\_\_ No. 1 \_\_\_\_\_ No. 2  
(Quantity) (Quantity)  
\_\_\_\_ No. 3 \_\_\_\_\_ No. 4  
(Quantity) (Quantity)

- Check enclosed (to which we have added applicable local tax)  
 Please invoice us.

NAME \_\_\_\_\_ TITLE \_\_\_\_\_

COMPANY \_\_\_\_\_

ADDRESS \_\_\_\_\_

CITY \_\_\_\_\_ ZONE \_\_\_\_\_ STATE \_\_\_\_\_

Please send FREE engineering bulletin on Kit No. \_\_\_\_\_

**Make More Money  
in  
MAINE**

*Sylvania's Waldoboro plant  
is a Blue Ribbon operation*

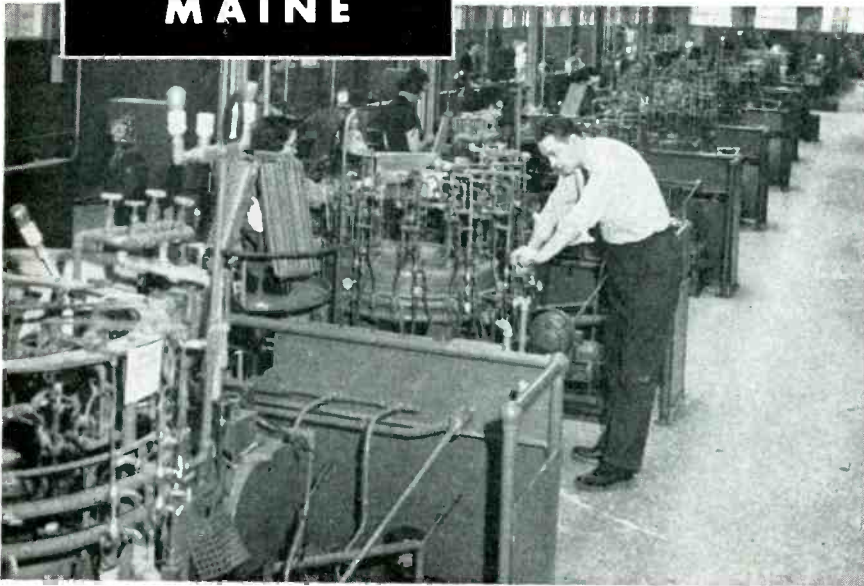

*Profitable Locations For The*

**ELECTRONICS INDUSTRY**

**MAINE**

**ADVANTAGES**

- Skilled Workers
- 
- Engineers
- 
- Favorable Tax Structure
- 
- Balanced State Budget
- 
- No State Income Tax
- 
- No State Excise Tax
- 
- Overnight to N. Y.
- 
- Air, Sea, Rail,  
Truck Transportation
- 
- Economical Power
- 
- Excellent Schools  
and Colleges
- 
- Ideal Climate
- 
- Year Round Recreation

"The dexterity, inherent skills, pride in workmanship and high productivity of Maine workers have been most important factors in making our Maine plant a 'blue ribbon operation' says a leading Electronics manufacturer.

**NEED ENGINEERS?**

A recent survey disclosed that hundreds of trained engineers desire to work and live in Maine. A list of them is available to concerns locating in Maine.

*You can make more money and  
live happier in the Pine Tree State.*

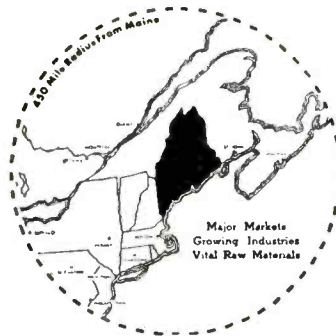

Write in confidence for the new FREE brochure "Make More Money in Maine" and special bulletin on the Electronics industry. Use our Site Selection Service.

**MAINE DEPT. OF DEVELOPMENT  
OF INDUSTRY & COMMERCE**

STATE HOUSE      AUGUSTA 14, MAINE

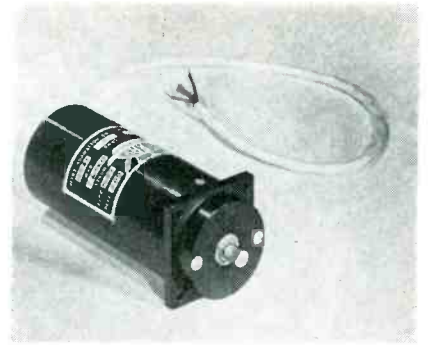

planetary gear train with integral filter. Length of the unit is 2.912 in. from mounting flange.

► **Uses**—Applications include use in timing units for telemetering, commutator switching and kindred functions.

Designed and developed by El Ray, the motor is designated as that company's number 1700-9-1, and meets noise specification MIL-I-6181B.

Additional specifications are: load, 3 in. oz; weight 5½ oz; and output speed may be specified for 15, 20, 150, 300, 600 or 1,800 rpm. Circle P35 inside back cover.

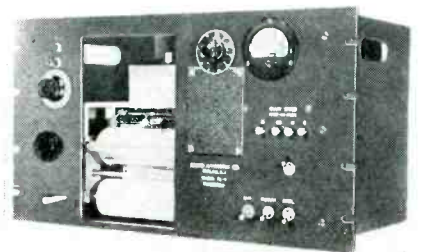

**RECORDER**

shows frequency response

SOUND APPARATUS Co., Stirling, N. J., has produced a new frequency response recorder, model SL-4, for electrical and electro-acoustical measurements. This recorder utilizes a patented electrodynamic principle for the operation of the stylus or pen. Special features are: a variable, electronically controlled writing speed and damping of the pen movement.

The instrument records on a 4-in. wide chart at chart speeds of 4½ in., 9 in. and 18 in. per min-

**WARNER ELECTRIC BRAKE & CLUTCH CO.**

*"puts the finger" on  
automatic rug machinery  
with the aid of*

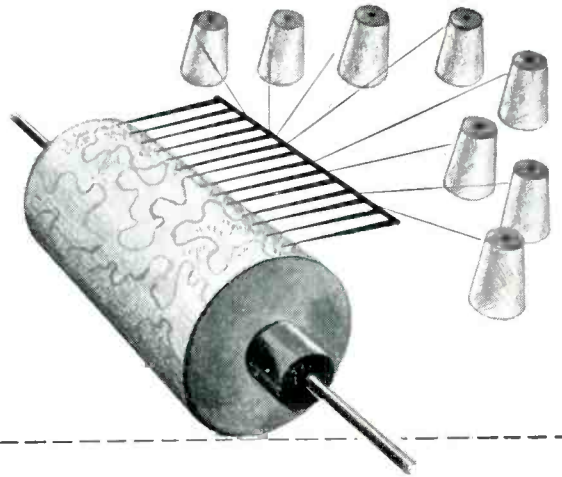

## **RADIO RECEPTOR SELENIUM RECTIFIERS**

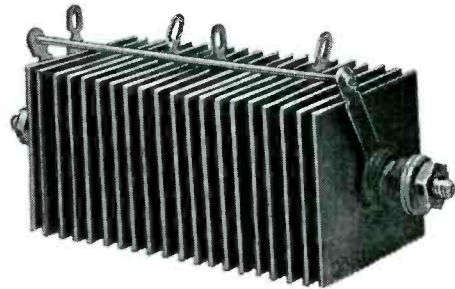
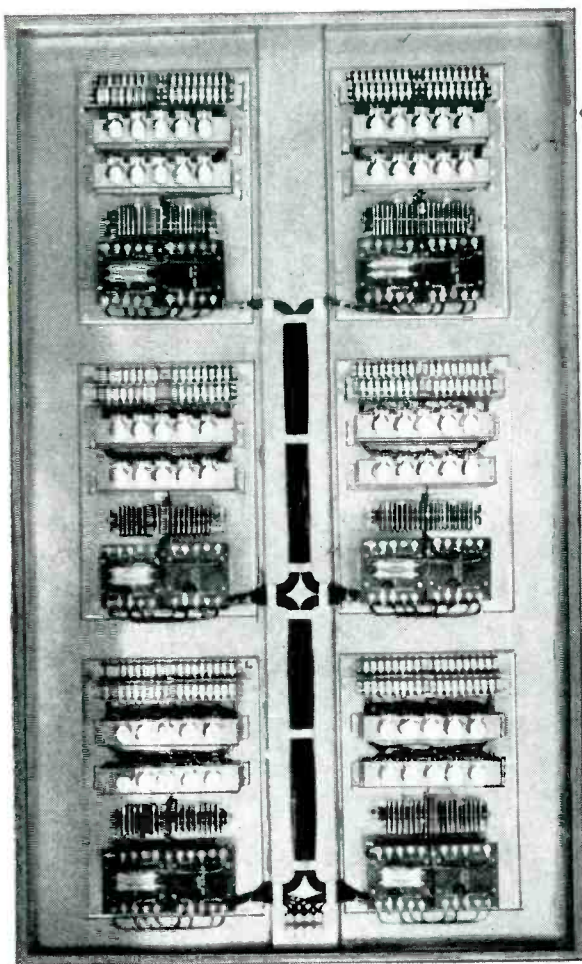

Guiding the 120 electric clutches that act as automated fingers in a new rug tufting machine is a Warner control panel whose key components are six Radio Receptor rectifiers. These fingers "feel" the rug pattern on a revolving roll, send information to the control station from which actuating impulses are relayed to clutches controlling yarn feed.

A Radio Receptor customer for many years, Warner Electric Brake & Clutch Co. utilizes RRco. selenium rectifiers in this application and many others because long experience has proved they can depend upon them for continuous and heavy duty, without fear of costly breakdowns.

If you have a problem in rectification, do as many fine companies do in the United States and throughout the world — Specify RRco. selenium rectifiers. Millions are in service in almost every possible type of circuit. Would you like our most recent literature? Please write section E-18.



*Semiconductor Division*  
**RADIO RECEPTOR COMPANY, INC.**

*Radio and Electronic Products Since 1922*

240 WYTHE AVENUE, BROOKLYN 11, N. Y. EVERGREEN 8-6000

**OTHER PRODUCTS OF RADIO RECEPTOR:** Germanium and Silicon Diodes, Dielectric Heating Generators and Presses, Communications, Radar and Navigation Equipment.

# DECADE RESISTANCES & VOLTAGE DIVIDERS

delivered from stock

Accuracy: 10 ohms and  
above:  $\pm 0.1\%$   
1 ohm:  $\pm 0.25\%$   
0.1 ohm:  $\pm 1\%$   
0.01 ohm:  $\pm 5\%$

Temp. Coeff.:  $\pm 0.002\%$  per degree C.  
Maximum Load:  $\frac{1}{2}$ -watt per step  
Frequency Limit: Non-inductive  
to 20KC

## DECADE RESISTANCE BOXES

Type	Dials	Ohm Steps	Total Resistance—Ohms	Price
817	3	0.01	11.1	\$60.00
818	3	0.1	111	51.00
820	3	1	1,110	56.00
821	3	10	11,100	60.00
822	3	100	111,000	63.00
823	3	1,000	1,110,000	77.00
824	3	10,000	11,100,000	120.00
817-A	4	0.01	111.1	75.00
819	4	0.1	1,111	71.00
825	4	1	11,110	77.00
826	4	10	111,100	79.00
827	4	100	1,111,000	92.00
828	4	1,000	11,110,000	139.00
8285	5	0.1	11,111	94.00
829	5	1	111,110	101.00
830	5	10	1,111,100	113.00
831	5	100	11,111,000	155.00
817-C	6	0.01	11,111.1	105.00
8315	6	0.1	111,111	109.00
832	6	1	1,111,110	121.00
833	6	10	11,111,100	169.00

## UNMOUNTED DECADE RESISTANCES

Type	Dials	Ohm Steps	Total Resistance—Ohms	Price
435	1	0.1	1	\$12.00
436	1	1	10	13.25
437	1	10	100	13.25
438	1	100	1,000	15.00
439	1	1,000	10,000	16.00
440	1	10,000	100,000	18.50
441	1	100,000	1,000,000	32.50
442	1	1,000,000	10,000,000	60.00

## DECADE VOLTAGE DIVIDERS (Potentiometers)

Type	Dials	Ohm Steps	Total Resistance—Ohms	Price
845	3	1	1,000	98.00
837	4	0.1	1,000	126.00
835	4	1	10,000	132.00
836	4	10	100,000	146.00

**SHALLCROSS MANUFACTURING COMPANY**

522 Pusey Ave., Collingdale, Pa.

# Shallcross

NEW PRODUCTS

(continued)

ute selectable by manual controls. Various types of measurements can be recorded since the scale function depends on the input pot which can be furnished as db, linear or sq rt.

Dimensions are 10½ in. by 19 in. by 12 in. and the front panel is slotted for rack mounting. It can be conveniently linked to various oscillators, analyzers, and link units. Special link units and corresponding charts can be designed. Circle P36 inside back cover.

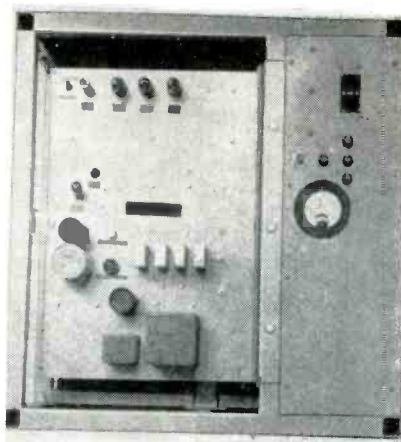

## D-C POWER SUPPLY

with fast response

DYNAMIC CONTROLS Co., 31 Davis Ave., Arlington 74, Mass. Balanced design in a new thyatron d-c power supply controlled by fast-acting circuits results in performance that has been exceeded only by series-tube supplies.

► Specifications — Ripple, peak to peak, is 0.1 percent. Load regulation, no load to full, is 0.15 percent; and line regulations,  $\pm 10$ -percent variation, is 0.15 percent. Response time is 10 milliseconds.

These compact supplies operate from 60 cps power and are available for output voltages up to 500 v and for currents larger than 3 amperes. Circle P37 inside back cover.

## TWO SLOTTED LINES

cover entire vhf-uhf range

FEDERAL TELEPHONE AND RADIO Co., 100 Kingsland Road, Clifton, N. J., has introduced two new slotted lines which, together, per-



## CENTRAL GLASS FIBRE WAVEGUIDES

ARE UP TO 80% LIGHTER THAN COMPARABLE METAL UNITS

An advanced new material, plus important new engineering ideas are combined to give you new heights in microwave versatility and design freedom. Feather-light, non-metallic CENTRAL GLASS FIBRE WAVEGUIDES have the same electrical characteristics as conventional silver plated microwave components — they meet all applicable MIL specifications — yet are up to 80% lighter.

Precision CENTRAL Components have the special features needed to solve many problems that have long plagued microwave engineers. GLASS FIBRE WAVEGUIDES will not corrode under salt spray . . . operate reliably from  $-200^{\circ}\text{C}$  to  $+150^{\circ}\text{C}$  with consistent characteristics. An extremely low coefficient of expansion guarantees more positive control of path length, than was ever possible before.

With GLASS FIBRE WAVEGUIDES, a radiating slot antenna can be produced by selectively removing the internal silver plating from the WAVEGUIDE. Since no physical holes are necessary for radiation, the slotted antenna can be pressurized.

GLASS FIBRE WAVEGUIDES permit the design and construction of more efficient FERRITE microwave devices.

Microwave requirements . . . standard or unique? CENTRAL GLASS FIBRE COMPONENTS and special systems engineering services can meet your most exacting applications.

### CENTRAL MICROWAVE CATALOG

Send for free CATALOG 8.56. It contains full technical information.

# lightweight champion

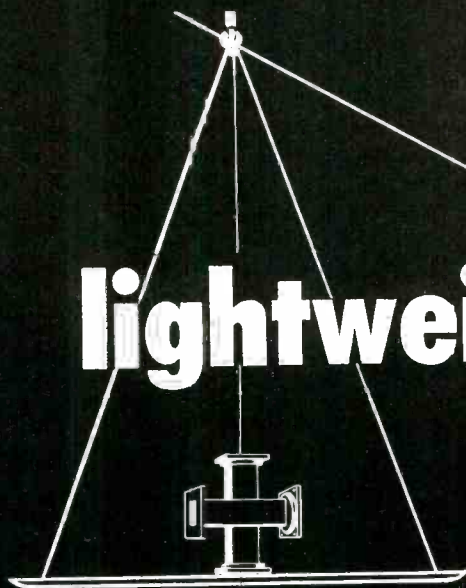

GLASS FIBRE WAVEGUIDE

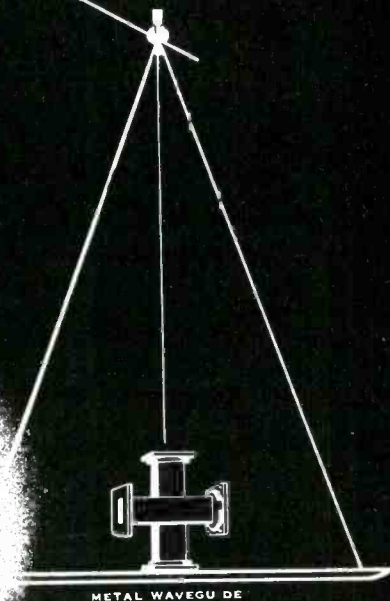

METAL WAVEGUIDE



## central electronic

MANUFACTURERS, INC.  
DENVER, NEW JERSEY  
SUBSIDIARY OF NUCLEAR CORPORATION OF AMERICA, INC.

### MICRO DEVICES DIVISION

CENTRAL ALSO MANUFACTURES A FULL LINE OF ELECTRONIC POWER TUBES, SPECIALIZED HIGH VACUUM, COMMUNICATIONS AND LABORATORY EQUIPMENT.

# ENGINEERS & PHYSICISTS

Electronics

## APL—An Organization Of And For Technical Men And Scientists

The Applied Physics Laboratory (APL) of the Johns Hopkins University is an organization of and for technical men and scientists. Several factors allow for more effective utilization of "mind power" at APL. They lead to tangible and intangible satisfactions for staff members that could not be gained elsewhere.

### Among them are:

1. Individual staff members are given a measure of responsibility and initiative much greater than in many comparable establishments. Decision-making, on all levels, is placed in the hands of scientists and technical men.
2. Staff members do not restrict their efforts to limited technical problems. Instead they are asked to assess and solve problems of a systems nature, including analyses of complete tactical problems.
3. APL handles technical direction of the work of many associate and sub contractors, including 21 universities and leading industrial organizations. As a result, APL staff members enjoy a rewarding exchange of ideas and techniques with other leaders in R & D.
4. The combined facilities of APL, its associate and sub contractors, and Government test stations provide opportunities for members of its technical staff to develop and exploit their varied capabilities in a unique environment where teamwork and individual initiative are fused.
5. This esprit and freedom to look into new concepts has resulted in a number of "quantum jumps" in defense capability, including the proximity fuze, the first supersonic ramjet engine, and the Navy's Bumblebee family of missiles which includes TERRIER, TALOS and TARTAR. APL is presently attempting breakthroughs on several important fronts.

APL's expansion program recently witnessed the completion of new laboratories covering 350,000 sq. ft. in Howard County, Maryland, equidistant from Washington, D. C. and Baltimore. Men of originality are invited to inquire about staff opportunities. Salaries compare favorably with those of other R & D organizations.

### OPENINGS EXIST IN:

**ANALYSIS:** Dynamic analysis of closed-loop control systems; analysis and synthesis of guidance systems; counter-countermeasures systems; electrical noise and interference.

**DESIGN:** Control and guidance circuitry; telemetering and data-processing equipment; microwave components, antennas, and radomes; transistor and magamp applications; external missile systems.

**TEST:** Prototype engineering and field test evaluation.

For Additional information write: Professional Staff Appointments

## The Johns Hopkins University Applied Physics Laboratory

8609 GEORGIA AVENUE,

SILVER SPRING, MD.

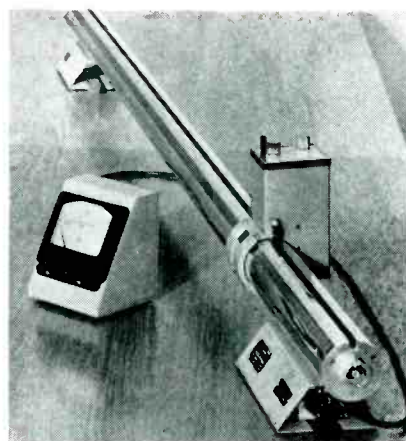

mit measurements to be made over the entire vhf-uhf range of frequencies. The lines are designated as types FT-LMM and FT-LMD.

Type FT-LMM (illustrated) covers the frequency spectrum from 80 to 300 mc. It has a residual vswr of 1.03 to 1 and the probe location can be read to an accuracy of  $-1$  mm. Type FT-LMD covers the range from 300 to 3,000 mc and has a vswr of 1.02 to 1. Its probe location can be read to an accuracy of  $-0.1$  mm. Both lines have their own built-in detectors and indicators.

### ► Measurements and Weights—

The FT-LMM is about  $2\frac{3}{4}$  in. in diameter and 7 ft,  $2\frac{3}{4}$  in. long. With its indicator it weighs about  $29\frac{1}{2}$  lb. The FT-LMD is about  $2\frac{1}{2}$  in. in diameter and  $24\frac{1}{2}$  in. long. With its indicator it weighs about  $14\frac{1}{2}$  lb. Specifications are available.

Circle P38 inside back cover.

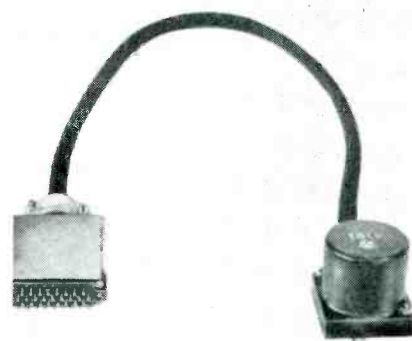

### PRECISION SWITCH for commercial uses

GENERAL DEVICES, INC., Princeton, N. J. A new series of plug-in connection 40-channel high-speed

# FREQUENCY STANDARDS

## PRECISION FORK UNIT TYPE 50



*Size 1" dia. x 3 3/4" H.\* Wght., 4 oz.*  
 Frequencies: 240 to 1000 cycles  
 Accuracies:—  
 Type 50 ( $\pm 0.02\%$  at  $-65^{\circ}$  to  $85^{\circ}\text{C}$ )  
 Type R50 ( $\pm 0.002\%$  at  $15^{\circ}$  to  $35^{\circ}\text{C}$ )  
 Double triode and 5 pigtail parts required  
 Input, Tube heater voltage and B voltage  
 Output, approx. 5V into 200,000 ohms

\*3 1/2" high  
 400 - 1000 cy.

## FREQUENCY STANDARD TYPE 50L

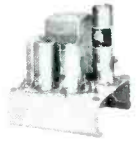

*Size 3 3/4" x 4 1/2" x 5 1/2" High  
 Weight, 2 lbs.*  
 Frequencies: 50, 60, 75 or 100 cycles  
 Accuracies:—  
 Type 50L ( $\pm 0.02\%$  at  $-65^{\circ}$  to  $85^{\circ}\text{C}$ )  
 Type R50L ( $\pm 0.002\%$  at  $15^{\circ}$  to  $35^{\circ}\text{C}$ )  
 Output, 3V into 200,000 ohms  
 Input, 150 to 300V, B (6V at .6 amps.)

## PRECISION FORK UNIT TYPE 2003



*Size 1 1/2" dia. x 4 1/2" H.\* Wght. 8 oz.*  
 Frequencies: 200 to 4000 cycles  
 Accuracies:—  
 Type 2003 ( $\pm 0.02\%$  at  $-65^{\circ}$  to  $85^{\circ}\text{C}$ )  
 Type R2003 ( $\pm 0.002\%$  at  $15^{\circ}$  to  $35^{\circ}\text{C}$ )  
 Type W2003 ( $\pm 0.005\%$  at  $-65^{\circ}$  to  $85^{\circ}\text{C}$ )  
 Double triode and 5 pigtail parts required  
 Input and output same as Type 50, above

\*3 1/2" high  
 400 to 500 cy.  
 optional

## FREQUENCY STANDARD TYPE 2005



*Size, 8" x 8" x 7 1/4" High  
 Weight, 14 lbs.*  
 Frequencies: 50 to 400 cycles  
 (Specify)  
 Accuracy:  $\pm 0.001\%$  from  $20^{\circ}$  to  $30^{\circ}\text{C}$   
 Output, 10 Watts at 115 Volts  
 Input, 115V. (50 to 400 cycles)

## FREQUENCY STANDARD TYPE 2007T TRANSISTORIZED



*Size 1 1/2" dia. x 4 1/2" H.\* Wght. 7 ozs.*  
 Frequencies: 240 to 1000 cycles  
 Accuracies:—Same as 2003, above  
 Type 2007S—Silicon type  
 Input, 28V.  
 Output, Multitap, 75 to 100,000 ohms  
 \*3 1/2" in 2007S, 400 to 800 cycles.

## FREQUENCY STANDARD TYPE 2121A

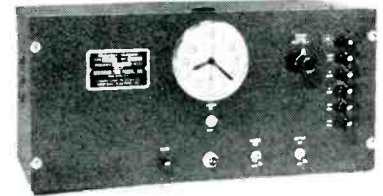

*Size  
 8 3/4" x 19" panel  
 Weight, 25 lbs.*  
 Output: 115V  
 60 cycles, 10 Watt  
 Accuracy:  
 $\pm 0.001\%$  from  $20^{\circ}$  to  $30^{\circ}\text{C}$   
 Input, 115V (50 to 400 cycles)

## FREQUENCY STANDARD TYPE 2001-2



*Size 3 3/4" x 4 1/2" x 6" H., Wght. 26 oz.*  
 Frequencies: 200 to 3000 cycles  
 Accuracy:  $\pm 0.001\%$  at  $20^{\circ}$  to  $30^{\circ}\text{C}$   
 Output: 5V. at 250,000 ohms  
 Input: Heater voltage, 6.3 - 12 - 28  
 B voltage, 100 to 300 V., at 5 to 10 ma.

## FREQUENCY STANDARD TYPE 2111C

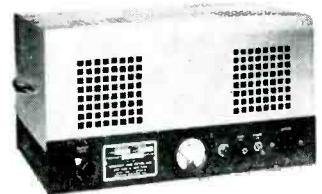

*Size, with cover  
 10" x 17" x 9" H.  
 Panel model  
 10" x 19" x 8 3/4" H.  
 Weight, 25 lbs.*  
 Frequencies: 50 to 1000 cycles  
 Accuracy: ( $\pm 0.002\%$  at  $15^{\circ}$  to  $35^{\circ}\text{C}$ )  
 Output: 115V, 75W. Input: 115V, 50 to 75 cycles.

## ACCESSORY UNITS for TYPE 2001-2



- L—For low frequencies multi-vibrator type, 40-200 cy.
- D—For low frequencies counter type, 40-200 cy.
- H—For high freqs, up to 20 KC.
- M—Power Amplifier, 2W output.
- P—Power supply.

*This organization makes frequency standards within a range of 30 to 30,000 cycles. They are used extensively by aviation, industry, government departments, armed forces—where maximum accuracy and durability are required.*

WHEN REQUESTING INFORMATION  
 PLEASE SPECIFY TYPE NUMBER

# American Time Products, Inc.

580 FIFTH AVENUE, NEW YORK 36, N. Y.

## THE WRONG POT . . . CAN MEAN TROUBLE!

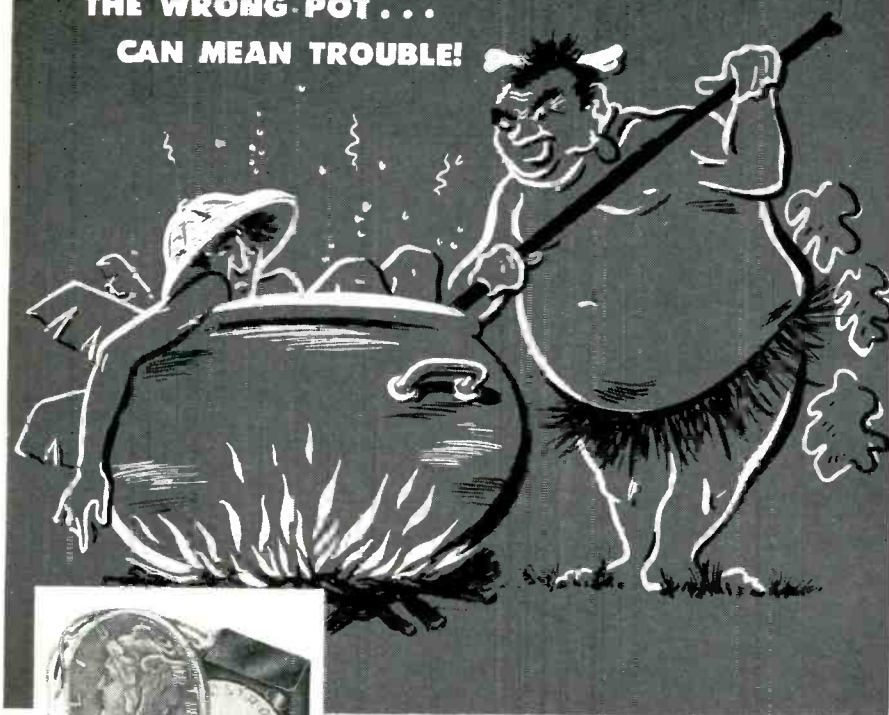

For the *right* pot,  
rely on DAYSTROM!

**Model 300-00** is the tiniest, precision-built, wire-wound trimming potentiometer this side of "Lilliput." Despite its flyweight size, it easily handles **exacting** jobs throughout extreme temperature ranges.

For higher resistance ranges, the Model 303-00 fills the bill — using very little more space than the Model 300-00.

The **Potentiometer Division** of Daystrom Pacific Corporation is staffed with highly skilled engineers and technicians who dearly love to grit their teeth and come up with optimum solutions to all kinds of potentiometer problems.

So, rely on **DAYSTROM** for your right pot!

### Some outstanding characteristics:

	Model 300-00	Model 303-00
Size.....	0.5" square by 0.187" thick	0.75" square by 0.28" thick
Weight.....	2 grams	7 grams
Resistance Ranges...	10 ohms to 50K	5K to 125K

Write today for literature on these or any of the many other production or custom-made precision potentiometers available. Names of local representatives on request.

Openings exist for highly qualified engineers.

POTENTIOMETER  
DIVISION

*Daystrom* PACIFIC CORPORATION

11150 La Grange Ave. West Los Angeles 25, Calif.

A SUBSIDIARY OF DAYSTROM, INC.

sampling switch is designed for commercial applications.

The versatile switches are easily adapted to a variety of motor drives. They are available with bronze or ball bearings and equipped with constant force brushes for extended service free life. Also featured are lifetime semimolded contact plates, convenient length cable terminating in miniature multipin plug.

► **Measurements**—Approximate dimensions are 1 $\frac{1}{8}$  in. sq by 1 $\frac{1}{2}$  in. long plus shaft  $\frac{1}{4}$  in. or  $\frac{3}{8}$  in. diameter by  $\frac{1}{2}$  in. long.

Current models include single or multiple pole, stacked, concentric, opposed, raised contact, segmented or printed circuit designs. A brochure is available on request. **Circle P39 inside back cover.**

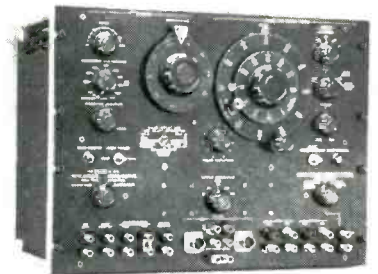

### PULSE SOURCE and measuring device

GENERAL RADIO Co., 275 Massachusetts Ave., Cambridge 39, Mass. Type 1391-A pulse sweep and time-delay generator is a pulse source and measuring device designed to meet the diverse requirements of laboratories engaged in time-domain measurements. It produces pulses of medium power and good rise-time over a wide range of durations and repetition rates, and it generates time delays and saw-tooth sweeps over comparably wide time intervals.

► **Specifications** — The time-delay generator has a calibrated range from 1  $\mu$ sec to 1.1 sec; the linear sweep generator produces saw-tooth waveforms ranging in duration from 3.0  $\mu$ sec to 0.12 sec. The start and stop times of pulses,

# Chicago to New York — 15¢ a casting! Ship UNITED!

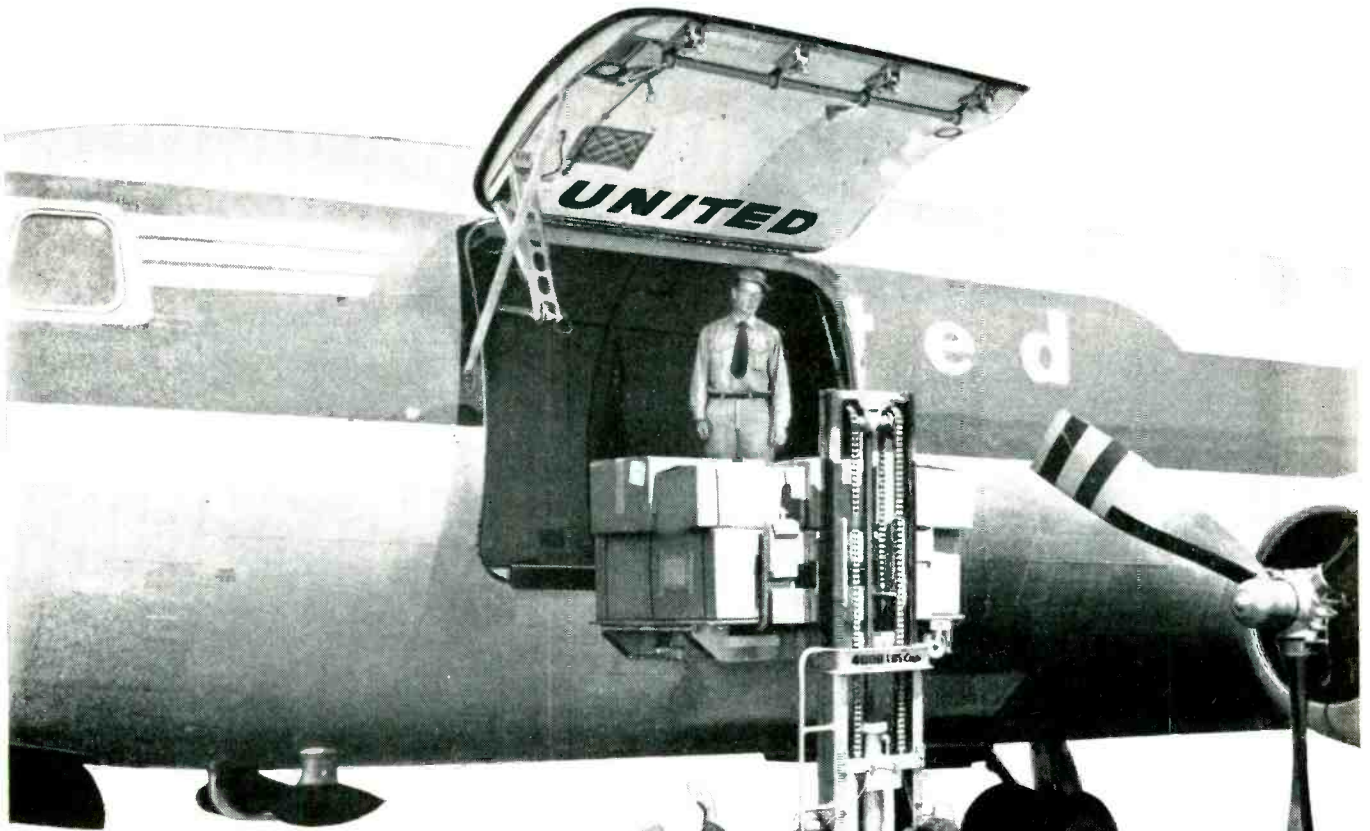

**TWO-POUND MACHINED CASTINGS** leaving Chicago aboard United's 300-mph DC-6A "Big Lift" Cargoliners arrive in New York in just 3 hours! Cost for 100-lb. shipment — \$7.50\*.

**AND YOU GET THESE UNITED "EXTRAS"** — Space dependability made possible by Reserved Air Freight. . . . On-time dependability, by weather-mapping radar. . . . Faster, safer handling, by pre-loaded aluminum pallets. . . . Day and night cargo service, by United's frequent Mainliner and Cargoliner schedules.

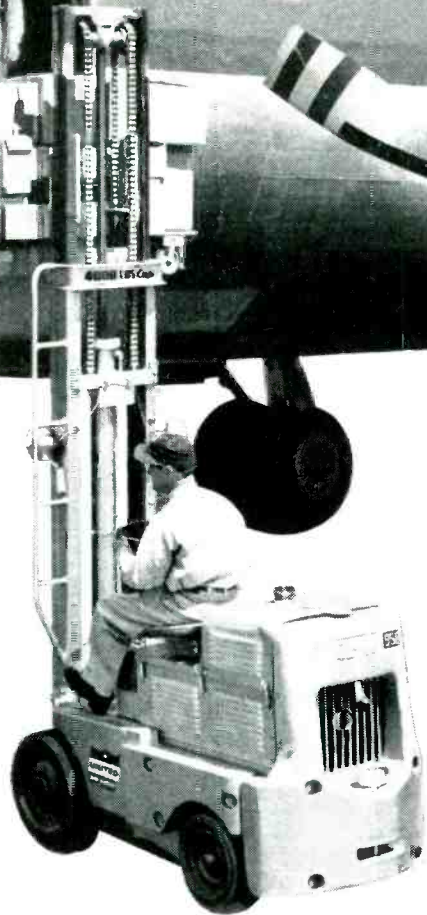

## Examples of United's low Air Freight rates

	per 100 pounds*
CHICAGO to CLEVELAND . . . . .	\$4.78
DENVER to OMAHA . . . . .	\$6.42
NEW YORK to CHICAGO . . . . .	\$7.50
SEATTLE to LOS ANGELES . . . . .	\$12.02
PHILADELPHIA to PORTLAND . . . . .	\$24.15
SAN FRANCISCO to BOSTON . . . . .	\$27.00

\*These are the rates for most commodities. They are often lower for larger shipments. Rates shown are for information only, are subject to change, and do not include the 3% federal tax on domestic shipments.

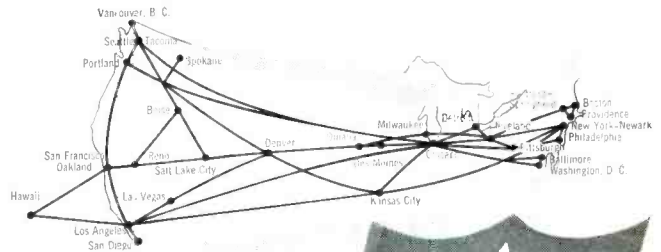

**SHIP FAST...SHIP SURE...SHIP**



For service, information, or free Air Freight booklet, call the nearest United Air Lines Representative or write Cargo Sales Division, United Air Lines, 36 South Wabash Avenue, Chicago 3, Illinois.

# PROVEN Design Techniques make your COMPLEX AUDIO FILTER CONSTRUCTION routine at CHICAGO STANDARD

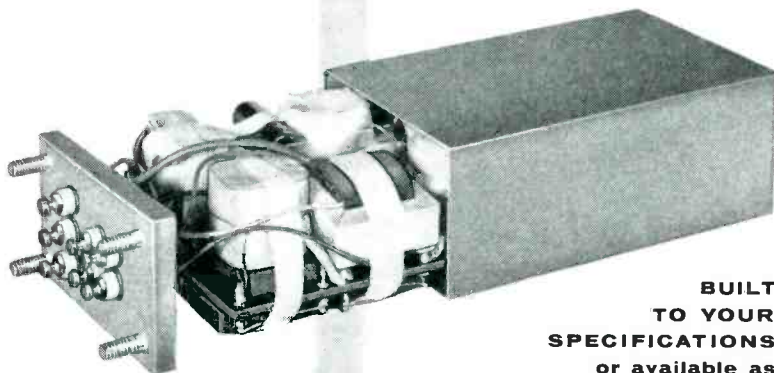

**BUILT  
TO YOUR  
SPECIFICATIONS  
or available as  
stock units.**

Chicago Standard's years of experience in building thousands of filters have made possible a degree of skill in engineering and workmanship that can solve your difficult audio filter problems quickly . . . to your complete satisfaction.

Proven techniques of space utilization and mechanical design result in superior internal construction and efficient, compact, light-weight filters.

Proven design principles result in optimum coil and circuit performance. Reliable operation under extreme conditions is assured by:

1. High efficiency core materials.
2. Chicago's high strength ceramic terminals.
3. High dielectric strength insulation.

## CHICAGO STANDARD TRANSFORMER CORPORATION



3501 Addison Street, Chicago 18, Illinois  
EXPORT SALES: Roburn Agencies, Inc.  
431 Greenwich Street, New York 13, New York

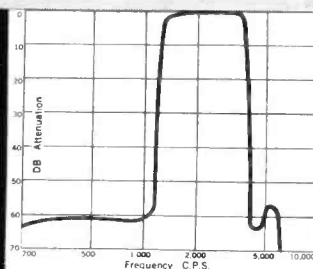

FREQUENCY RESPONSE  
Typical  
Band-Pass Filter



*Write Today*

outlining your filter requirements and for information on stock units.

NEW PRODUCTS

(continued)

which are continuously adjustable in duration from 0.05  $\mu$ sec to 0.1 sec, can be precisely set at any point along this sweep by amplitude comparators. The pulse repetition rate is set by an external generator which may have almost any waveform.

The unit is priced at \$1,745. Circle P40 inside back cover.

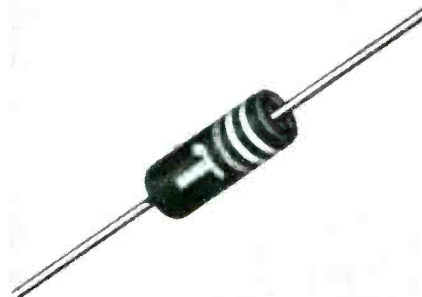

## SILICON DIODES high-conductance type

TRANSITRON ELECTRONIC CORP., Melrose 76, Mass. A new series of silicon junction diodes offers major space savings for miniaturized systems requiring efficient rectifiers, modulators and detectors. High voltage and current ratings, along with operation in ambient temperatures up to 200 C, have been combined to produce a rugged silicon diode suitable for printed-board power service.

Along with forward current ratings up to 200 ma, these units have inverse current of less than 0.25  $\mu$ a at voltages up to 225 v. Two type 1N486A diodes can deliver up to 400 ma at 65 v in a full-wave center tapped circuit.

Specifications, ratings and application information are found in bulletin TE-1339. Circle P41 inside back cover.

## VIBROMETER shows mechanical vibration

TELEVISI CORP., 1415 Golf Road, Des Plaines, Ill. Model 12A Vibrometer measures conveniently and accurately, acceleration, ve-

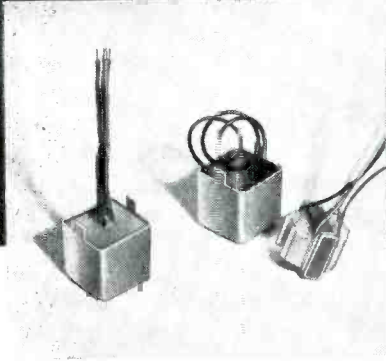

An Installation of Leeson Coil Winders in the Lenkurt Electric Company plant, San Carlos, Calif. Inset shows, left to right: a Lenkurt miniaturized high frequency transformer fully assembled; the transformer casing; and the transformer coil, precision-wound to extremely close tolerances on a fast Leeson No. 108 Hand Feed Coil Winder.

# LENKURT selects Leeson No. 108 Coil Winders for high-precision accuracy

As a leading designer and manufacturer of carrier equipment, the Lenkurt Electric Company of San Carlos, California, supplies the complex electronic apparatus used throughout the world by telephone companies in adding long-distance circuits. For winding the close-tolerance coils that go into this multi-channel communications equipment, Lenkurt depends on Leeson No. 108 Coil Winders. Chester Scarce, Factory

Manager of Lenkurt, reports:

*"Our transformers call for coils of the finest quality to meet the high-precision standards of modern carrier equipment. We find that Leeson No. 108 Hand Feed Coil Winders give us not only the high degree of accuracy we must have, but worthwhile economy as well."*

Leeson No. 108 Machines are the easiest to operate, most accurate and flexible hand feed coil winders ever

developed. Winding four to thirty paper-insulated coils in stick form simultaneously, they reduce set-up time and speed production on long or short runs.

### Get the Facts

on how you can improve and economize your own operations. Use the coupon for further facts on Leeson No. 108 Hand Feed Coil Winders, and for other helpful coil winding information.

238.57

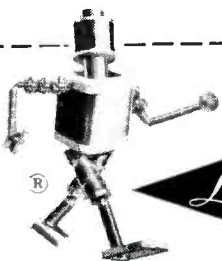

FOR WINDING COILS  
IN QUANTITY...  
ACCURATELY...USE  
LEESONA WINDING MACHINES

## UNIVERSAL WINDING COMPANY

P. O. BOX 1605, PROVIDENCE 1, RHODE ISLAND, Dept. 210

Please send me

- Bulletin on the Leeson No. 108 Hand-Feed Coil Winder.
- Condensed catalog of Leeson Winders.
- Bulletin on the new Leeson Pay-As-You-Profit Plans for purchasing or leasing modern coil winding machinery.

Name.....Title.....

Company.....

City.....Zone.....State.....

# ENGINEERING TIMETABLE



## 10:20 AM - TEST CELL AT 20,000 FEET

### Senior Electronics Engineers:

Missile systems

### Senior Electronics Engineers:

Servo and Analog  
Computer experience

### Project Engineers:

Electronics or  
Electromechanical  
background

### Senior Aerodynamicists:

Supersonic Aerodynamics,  
includes performance,  
stability and control  
analysis



... WHERE THE FUTURE IS MEASURED IN LIGHT-YEARS!

# FAIRCHILD

GUIDED MISSILES DIVISION • WYANDANCH, LONG ISLAND, N. Y.

A Division of Fairchild Engine and Airplane Corporation

Because certain equipment cannot be tested except under actual operating conditions, Fairchild Guided Missiles Division maintains a C-82 with full test facilities. It's all part of a day's work for FGMD engineers to conduct the follow-through on their projects in oxygen harness 20,000 feet in the air.

FGMD engineers work together in small team units, seeing their projects through from start to finish. By pooling engineering brainpower in this way, more effective thinking is put to work solving problems in such fields as inertial guidance, passive guidance and radar, and entire, new missile systems.

It makes a dynamic, challenging engineering picture. Inspect the positions listed on the left. If you see your qualifications, arrange an interview.

Send your resume, in confidence of course, to R. B. Gulliver.

NEW PRODUCTS

(continued)

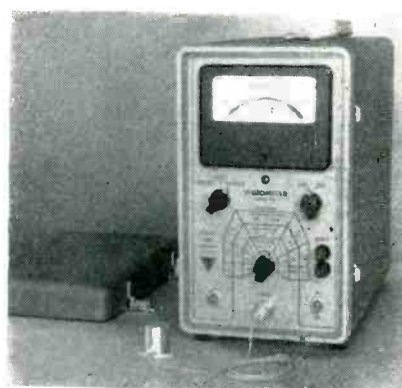

locity and displacement of mechanical vibrations from 3 cps to 20,000 cps. It measures displacement as small as 0.0001 in. and as great as 3.0 in.; velocities from 0.03 in./sec to 1,000 in./sec; accelerations from 10 in./sec/sec to 300,000 in./sec/sec (0.03 g to 780 g).

Used with an oscilloscope, it permits quantitative analysis of impact shock and impulsive motions. A polarity switch is provided for determining positive and negative peaks of vibration. A miniaturized, lightweight pickup probe makes possible accurate measurements on small, low-energy vibrating systems.

The instrument measures 14 in. by 8 in. by 16 in. Weight is 22 lb. Circle P42 inside back cover.

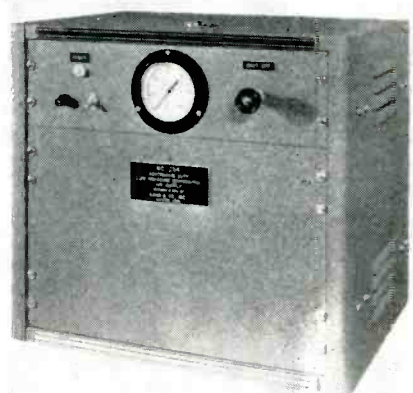

### LOW PRESSURE DRYER is completely automatic

KAHN AND Co., INC., 543 Windsor St., Hartford 1, Conn., has announced a new series of low pressure adsorption gas dryers designed specifically for such applications as the pressurizing of coaxial cables and waveguides, and the elimination of moisture



# At Last!

- POSITIVE MOISTURE SEAL
- PERFECT STRAIN RELIEF
- ARC-OVER PREVENTION
- CORONA SUPPRESSION

## in SIMPLE, RUGGED CONNECTORS using ALDEN "IMI" (integral molded insulation) TECHNIQUE

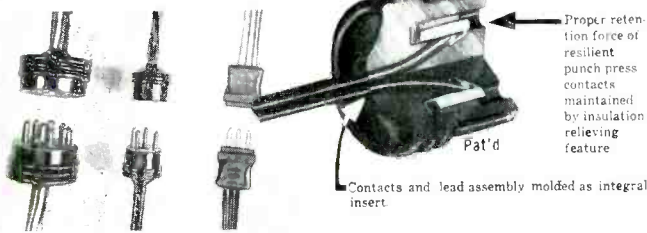

NOW—for the first time—you can have sealed connectors without tedious preparation, intricate assembly, or lengthy curing time.

INSTEAD—Alden "IMI" using the patented techniques shown above make it possible to mold the insulation directly around the contacts and leads in one compact, lightweight assembly.

This advanced technique has now made possible a whole new series of reliable connectors and unit cable assemblies. Write today for the new Alden "IMI" Connector Guide.

### SINGLE LEAD ALDEN "IMI" CONNECTORS

#### Alden "IMI" High Voltage Disconnects

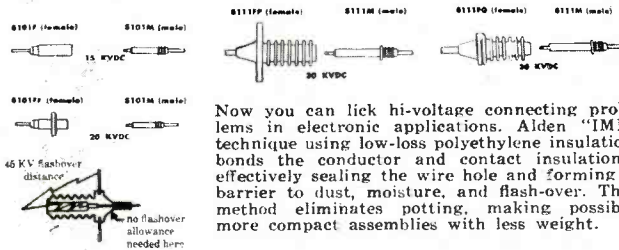

Now you can lick hi-voltage connecting problems in electronic applications. Alden "IMI" technique using low-loss polyethylene insulation bonds the conductor and contact insulations, effectively sealing the wire hole and forming a barrier to dust, moisture, and flash-over. This method eliminates potting, making possible more compact assemblies with less weight.

#### Alden "IMI" Tube Cap Connectors

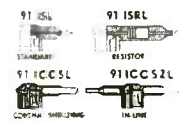

These are a series of new Alden "IMI" Tube Cap Connectors for 1/4", 3/8", and 5/16" plate caps. Because Alden "IMI" technique provides sealed construction, these connectors are ideal for rectifier, pulse, output, and transmitter tubes operating at high voltages or at high altitudes. Available in a variety of insulation types to meet all types of operating conditions.

#### Mini-test Point Jacks and Test Prods

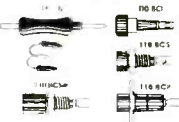

Here's the latest in insulated test prods and jumper pairs. Using the Alden "IMI" technique, prod tip and lead are integrally molded in a shot of low loss polyethylene. Superior to phenolic insulated test prods, they won't break, crack or chip. They're ideal for instruments, meters, patch boards, and program panels.

### 2 TO 5 LEAD ALDEN "IMI" CONNECTORS

#### "IMI" Miniature Disconnects

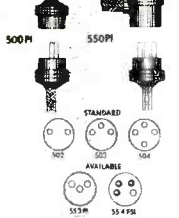

Here's a series of compact, polarized Alden "IMI" miniature disconnects with 2 to 5 contacts. For the first time in so little space you get a connector with all the advantages of potting without added bulk, lengthy curing time, and intricate assembly. They can be used as individual disconnects or made into complete unit cabling assemblies... all tailored to your specs and production requirements. For a choice of layouts, see sketches.

### CUSTOM LEAD ALDEN "IMI" CONNECTORS

#### "IMI" Synchro Camera Flash Cable



Precision designed and precision molded cable for synchronizing flash gun to camera. Reliable Alden "IMI" design assures positive results with every flash, and rugged construction makes this a lifetime connector.

#### "IMI" 12 Pin Piloting Plug



This space-saving Alden "IMI" 12-pin connector can be used alone or as part of a multi-connector unit cable assembly. Keyed boss provides easy piloting. Simple construction eliminates intricate assembly, yet assures perfect reliability. Handles up to 12 leads tailored to your specs.

#### "IMI" Flat Cable Plug



Compact 12-pin right angle plug uses popular flat lead. Fits 12 contact (octal type) socket. Standard plug insulation is maroon tenite; others available.

#### "IMI" Std. 7 Pin Plug



Standard small 7-pin Alden "IMI" plug fits standard small 7-pin tube socket or connector. Tenite insulation is standard for lowest cost; other types available. Provides 100% insulation of contacts, seals wire entrance, and resists breakage.

### 2 TO 3 LEAD ALDEN "IMI" CONNECTORS

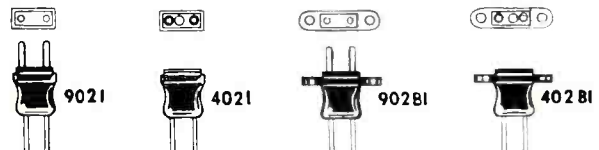

#### "IMI" Antenna Connectors

Designed originally as 300 ohm transmission line connectors, these compact, unbreakable two and three (polarized) lead Alden "IMI" connectors are useful in many types of low voltage applications. Available in low-loss polyethylene or polyvinyl (standard) insulation.

#### "IMI" Power Disconnects

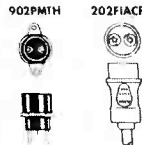

Solve your AC/DC power input or extension problems with this new two-wire Alden "IMI" Detachable Power Disconnect. Compact design eliminates bulk, saves space, yet each resilient punch-press contact is completely insulated with wear resistant polyvinyl.

#### "IMI" Grounding Power Disconnects

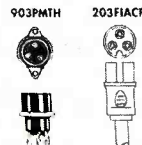

Eliminate shock hazard in your equipment with a new Alden "IMI" Grounding Power Disconnect for power input or extension. Female contacts are "top connected" for positive strain relief, and each sits in a protective pocket of polyvinyl insulation for maximum protection against mechanical or electrical failure.

### 4 TO 11 LEAD ALDEN "IMI" CONNECTORS

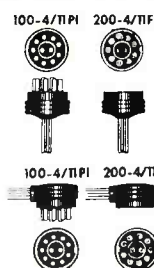

#### "IMI" Non-Interchangeable Connectors

Replace your potted AN connectors with this series of rugged Alden "IMI" non-interchangeable connectors having from 2 to 11 contacts. Keyed bosses that usually crack or break off have been eliminated. Polarization is effected by short, stubby pins in non-interchangeable pattern. Contacts, inserts, and conductors are completely sealed by the Alden "IMI" technique.

... for FREE BOOKLETS ...

#### What's New at Alden's

Four page illustrated booklet describes "IMI" Technique, gives application stories and shows various unit cables and connector combinations.

#### Alden "IMI" Handbook Supplement

Designed as a supplement to be added to the Alden Handbook this four page booklet illustrates many Alden "IMI" Connector Designs with complete specs.

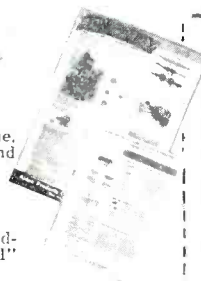

#### TEAR OUT THIS COUPON

ALDEN PRODUCTS COMPANY, 117 NORTH MAIN ST. BROCKTON, MASS.

PLEASE SEND ME FREE BOOKLETS... "What's New" and "IMI Handbook Supplement"

NAME \_\_\_\_\_ TITLE \_\_\_\_\_

CHIEF PRODUCT OR SERVICE of your Group or Division: \_\_\_\_\_

COMPANY \_\_\_\_\_

ADDRESS \_\_\_\_\_

CITY \_\_\_\_\_ STATE \_\_\_\_\_

ACEPOT\*  
ACETRIM\*

# Sub-Miniature Potentiometers and Trimmers

1/2" size, precision wire-wound,  
up to 250K,  $\pm 3\%$  linearity

setting new standards  
for dependability  
in sub-miniaturization

Let the facts speak for themselves! ACE Sub-Miniature Precision Wire-Wound Potentiometers and Potentiometer Trimmers are the result of 4 years development and over a year of successful use by leading electronic equipment manufacturers. Users have conclusively proved that ACEPOTS and ACETRIMS meet requirements for space and weight saving compactness, while at the same time meeting MIL specs' most stringent qualifications for performance and dependability. Why invite trouble with untested components when you can protect your reputation with ACEPOT and ACETRIM . . . the subminiature potentiometers and trimmers proved in actual use.

## Condensed Engineering Data

	ACEPOT (potentiometer)	ACETRIM (trimmer)
Resistance Range	200 $\sim$ to 250K $\pm 2\%$	10 $\sim$ to 150K $\pm 3\%$
Linearity	$\pm 3\%$	$\pm 3\%$
Resolution	extremely high	excellent
Ambient Temperature	$-55^{\circ}\text{C}$ to $125^{\circ}\text{C}$ *	$-55^{\circ}\text{C}$ to $125^{\circ}\text{C}$
Torque	low or high	low or high

The above specifications are standard — other values on special order.

Available in threaded bushing, servo, flush tapped hole or flange mounting, and ganged units. All units sealed, moistureproofed, and anti-fungus treated. Meet applicable portions of JAN specs and MIL-E-5272A standards.

\*New X-500 ACEPOT operates to a new high of  $150^{\circ}\text{C}$ .

Expedited delivery on prototypes; prompt servicing of production orders.  
Send for Fact File and application data sheets.

\*trademarks applied for

ACEPOT\*  
ACETRIM\*

## ACE ELECTRONICS ASSOCIATES

Dept E, 101 Dover St. • Somerville 44, Massachusetts

condensation in the manufacture of electronic components. Units are completely automatic with twin adsorption towers to assure a continuous flow of dry gas at dew-points of  $-50^{\circ}\text{F}$  or lower. Explosion proof construction is available for hydrogen service. Circle P43 inside back cover.



### SERVO MOTORS low-inertia type

BASLER ELECTRONICS, INC., Highland, Ill. High reliability is featured in this size 15 servo motor. Class H and Class B materials are utilized to allow safe operation over extreme temperatures of from  $-60^{\circ}\text{C}$  to  $120^{\circ}\text{C}$ .

► Other Specifications—Input is 115 v a-c, 400 cps. No load speed is 5,000 rpm and stall torque is 1.5 in. oz. Bearings are stainless steel with special high-temperature lubricants.

Model M-110 has a 13-tooth, 120-pitch pinion. Model M-111 has a 15-tooth, 96-pitch pinion. Circle P44 inside back cover.

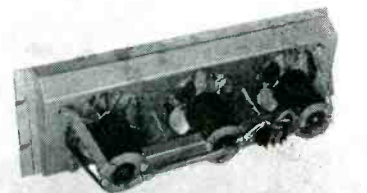

McLEAN Model 3E40 Rack Cooling Fan

### RACK COOLING FAN ideal for limited space

McLEAN ENGINEERING LABORATORIES, Princeton, N. J., is in production with the new model 3E40 rack

# NEW RAYTHEON PRODUCTS

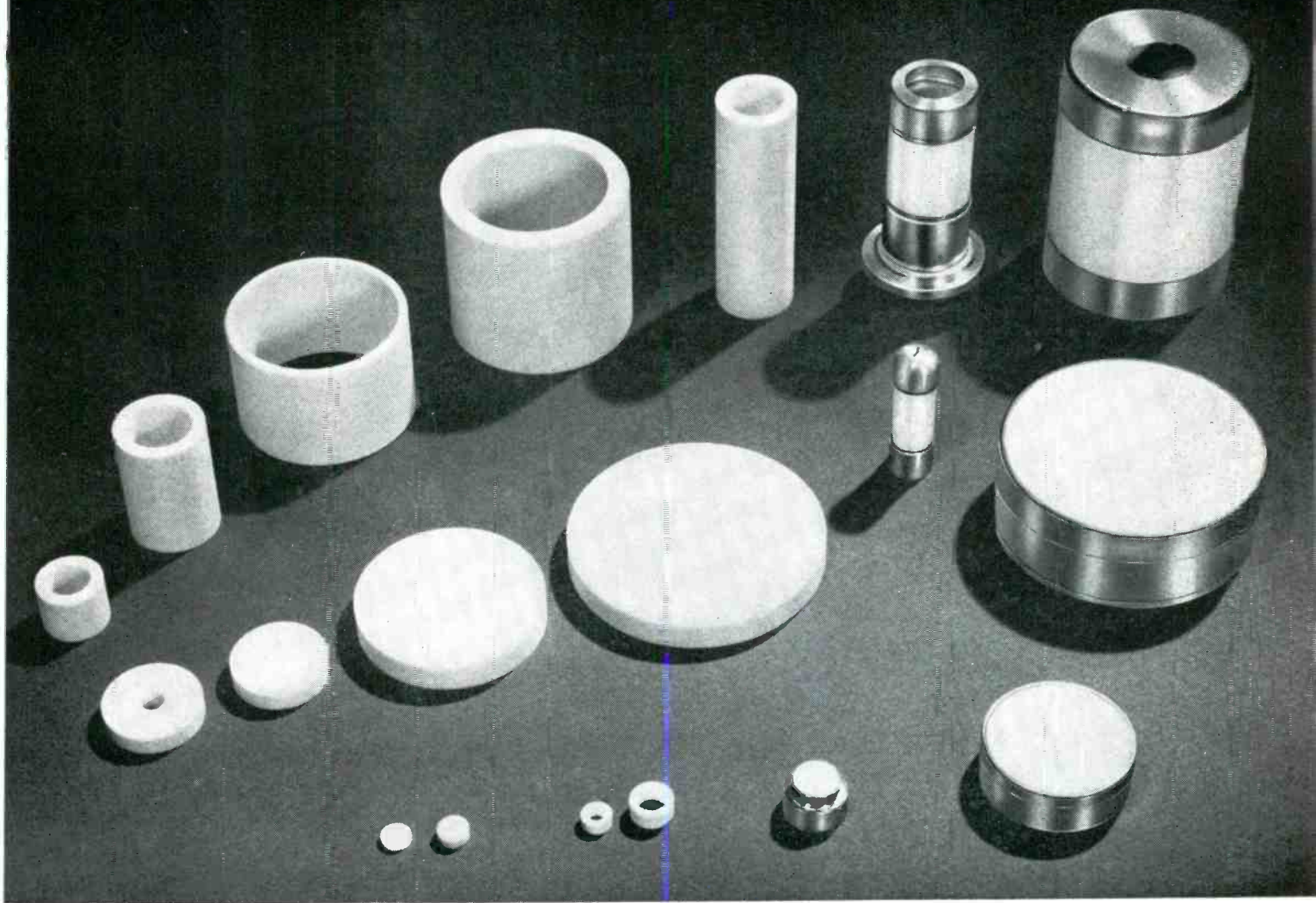

## For those who need the most demanding ceramic characteristics ... RAYTHEON R-95 HIGH-ALUMINA

We make only one kind of ceramic—high-alumina. As a manufacturer of tubes, Raytheon demands ceramic quality of utmost *purity* and *controlled consistency*. Our own R-95 ceramic meets these exacting demands.

You will find R-95 high-alumina ceramic completely dependable where high strength, high temperature, reliable vacuum seal, improved electrical performance, and high corrosion or abrasive resistance applications are involved. Raytheon will supply ceramic parts manufactured from R-95 high-alumina either alone or as hermetic ceramic-to-metal assemblies in accordance with your specifications. The assemblies can subsequently be soft or hard soldered into your production in your own plant.

Write for complete specification sheet. Supply us with a sketch or drawing outlining dimensions and tolerances, together with operational conditions. We will be happy to provide information and assistance on any of your ceramic requirements—without cost or obligation.

### Bright Futures for Ceramic Engineers

Join an outstanding group of engineers in expanded ceramic development, working in the most modern ceramic plant in operation. Fascinating projects, excellent salaries, fine living conditions. Write address below.

**RAYTHEON MANUFACTURING COMPANY**

Ceramic Sales

Waltham 54, Massachusetts



*Excellence  
in Electronics*



## RUGGED McCoy CRYSTALS ...

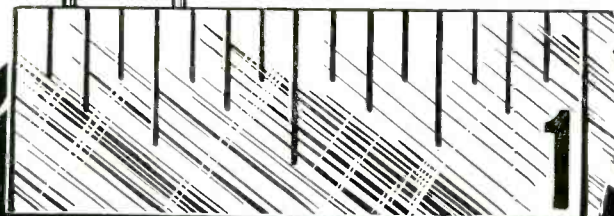

*Whip Size and  
Weight Problems*  
...With No Loss of Stability  
and Dependability!

McCoy "McMite" lightweight quartz crystals extend the limits of electronic design. These little, hermetically sealed units pack regular size performance into minimum space. There is no sacrifice of stability or dependability. McCoy "McMites" are built rugged to function at full efficiency even under extreme vibratory and shock conditions.

When weight and size are important, use McCoy "McMite" crystal units for lightness and compact size.

**FREE ILLUSTRATED CATALOG.** Write for your copy today.

**McCoy ELECTRONICS COMPANY**  
MT. HOLLY SPRINGS, PENNA.  
Phone 376 and 377



**BOTH  
SHOWN  
ACTUAL  
SIZE**

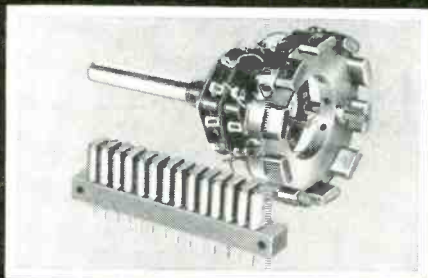

Fourteen McCoy "McMites" easily fit into a three-inch strip . . . ten of them are spaced on this two-inch diameter switch without crowding. Available in plug-in type (M-21) or with flexible wire leads (M-20) for frequencies from 3 mc. to 125 mc.

cooling fans for electronic cabinets. It fits standard 19-in. racks but occupies a space only 5½ in. high. It has RETMA matching for ready installation and is complete with filter and 5½ in. by 19 in. stainless steel grill. No color matching is required.

Air delivery is 140 cfm. The motors are placed at an angle so that the unit may be installed either downward or upward angle of air discharge. This construction enables the unit to be used where space is at a premium. Modifications are available to customers' specifications. Circle P15 inside back cover.

### TV RECEIVING TUBES nine miniature types

GENERAL ELECTRIC Co., Schenectady 5, N. Y., has announced 9 miniature tv receiving tubes.

Types 6BN4, 3BN4, and 2BN4 are 7-pin triodes developed for use as r-f amplifiers in vhf tv tuners. The 6BN4 heater is rated 6.3 v and 200 ma; the 3BN4, 2.8 v, 450 ma; and the 2BN4, 2.1 v, 600 ma. They are designed for series-connected circuits.

The 5BK7-A has a heater warm-up characteristic of 11 sec. Heater voltage is 4.7 v.

Types 4BC8 and 6BC8 are 9-pin medium-mu twin triodes designed primarily for use as a cascade r-f amplifier. The 4.2-v heater version also has been added to the company's line of 600-ma series-string circuits.

The 6CF6 is a 7-pin sharp cut-off pentode for use as a gain-controlled i-f amplifier added to the company's line of 300-ma heater tubes. It features high transconductance and low interelectrode capacitances.

Type 3CE5 and 4CE5, also 7-pin tubes, are designed for use as wide-band r-f amplifiers. Circle P46 inside back cover.

### TRANSISTOR TRANSFORMERS thirty-three new additions

ARGONNE ELECTRONICS MFG. CORP., 27 Thompson St., New York 13, N. Y. The addition of 33 new tran-

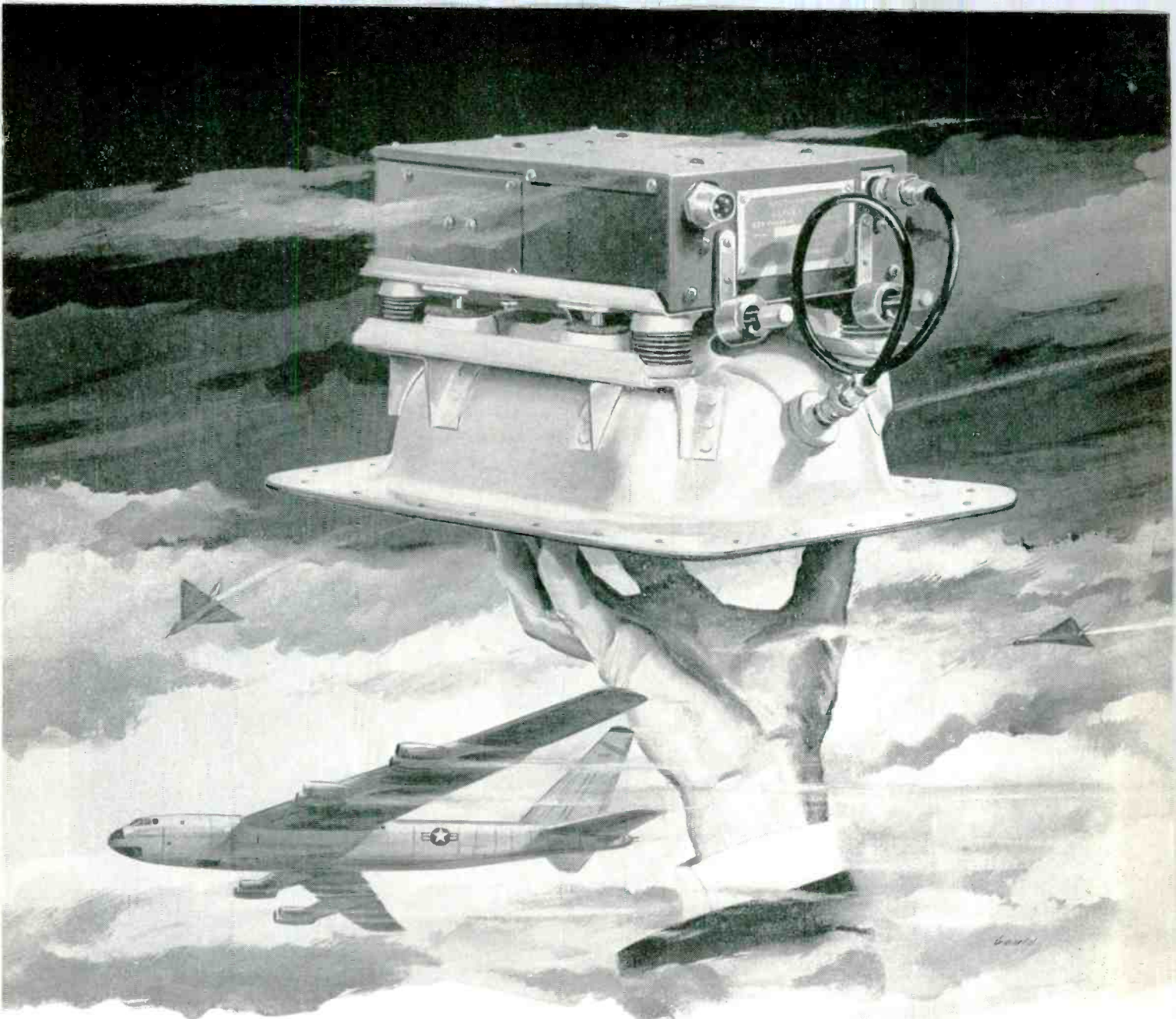

## **New radio marker beacon receiver takes 74% less space...63% less weight...63% less power**

Now, precious space, weight and power can be saved in aircraft construction when the design allows for the use of this new radio marker beacon receiver.

By using sub-miniature components and techniques, Stromberg-Carlson is now producing for the U. S. Air Force a receiver measuring 79 cubic inches in volume (compared with 308 in previous models); 3.9 pounds in weight (compared with 10.5); and requiring 15 watts power (compared with 40).

This new receiver (the AN/ARN-32) is easier to maintain because of the quick accessibility of its components. For example, the bottoms of tube sockets and wiring are easily reached from the outside.

In addition, the receiver is designed for unusually stable sensitivity and frequency.

Operating directly from the aircraft's 28-volt electrical system, the new receiver is effective at altitudes of 50,000 feet and at a temperature range of  $-68^{\circ}$  to  $160^{\circ}$ F. It meets all Armed Forces requirements for resistance to shock and humidity.

This highly specialized equipment is one more example of our role in the defense of our country in partnership with military aviation.

Engineers . . . excellent career opportunities in electronics and telecommunications. For complete details, write us today.

**STROMBERG-CARLSON COMPANY**

A DIVISION OF GENERAL DYNAMICS CORPORATION

General Offices and Factories at Rochester, N. Y.—West Coast plants at San Diego and Los Angeles, Calif.



'SCOPE RECORDING CAMERA  
SINGLE FRAME OR MOVING FILM  
1/2" TO 12,000" PER MINUTE

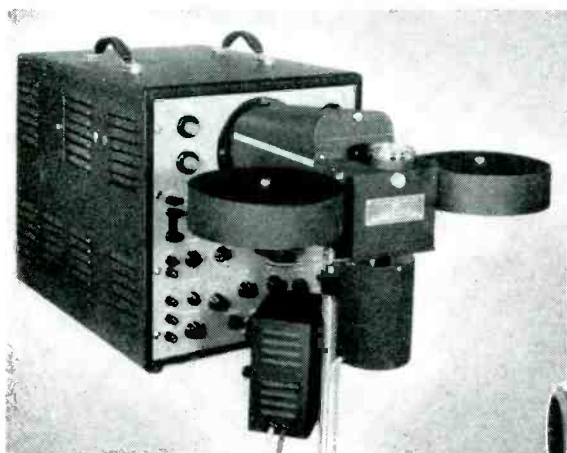

**NEW  
from  
ETC**

- f:1.5 camera, to 1/100 sec.
- adequate film magazine
- universal mounting tripod
- continuously variable motor speed control

*only one of its kind...*  
**ETC MODEL SM-100**

Accurate records are yours with this sensational, new ETC recording camera. Look at the range. Where else can you find such versatility? Or use the binocular viewer which allows continuous viewing in subdued light during the recording progress.

The ETC Model SM-100 recording camera is designed primarily for use with 5" oscilloscopes, can be mounted either in horizontal or vertical position, with provision also for use with larger, sloping-face console-type 'scopes.

This camera is typical of the pioneering development of ETC in its broad line of industrial and military electronic devices, as well as single- and multi-gun cathode ray tubes.

No matter how complicated your research or testing problem, if it involves electronics, bring it to ETC.



*IMPORTANT! Engineers and technicians interested in the advancement of oscillography, and the development, design and production of electronic tubes and instruments, will find profitable and congenial working conditions at suburban ETC. If you want to play it the substantial, sure way, write or phone K. C. Meinken, president, Electronic Tube Corporation, Chestnut Hill 7-6800.*

**ETC**

**\$885<sup>00</sup>**

f. o. b. Philadelphia



*SM-100 Camera mounted on 5" ETC oscilloscope. Inset shows tripod mounting and speed control.*

**FEATURES :**

- Wollensack f:1.5, 50 mm. coated lens.
- Shutter speeds 1 to 1/100 sec.
- Diaphragm f:1.5 to f:8.
- Object to image ratio 4.5:1.
- Miniature glow lamp provides timing marks on edge of film.
- Lamp excited at line frequency using pulse shaping circuit.
- Connections available for external marker timing pulses.
- Film magazines individually removable.
- Built-in light traps.
- Solenoid actuated drive with magnetic break in supply magazine; reduces film waste.
- 1/15 hp. motor with variac speed control; no warmup time needed.
- Direct reading tachometer in in./min.
- 115V., 50-60 cycles.
- 35 mm. film or paper (perforated or unperforated).
- 400 ft. film capacity (1,000 ft. supply slightly extra).
- Weighs 35 lbs.

sistor transformers to the company's line brings its total to 77 types. All are wound on nylon bobbins, with a Mylar outer wrap. Laminations are of nickel steel or silicon steel. All are supplied with color coded leads.

► **Other Specifications** — Average weight is 1 1/4 oz. Two sizes are used: 3/8 in. by 3/8 in. by 3/8 in. and 1 in. by 3/4 in. by 3/4 in.

Available with standard strap mount or printed circuit mount, they bridge the gap between the needs of miniaturization, power handling capacity and improved frequency response. Circle P47 inside back cover.

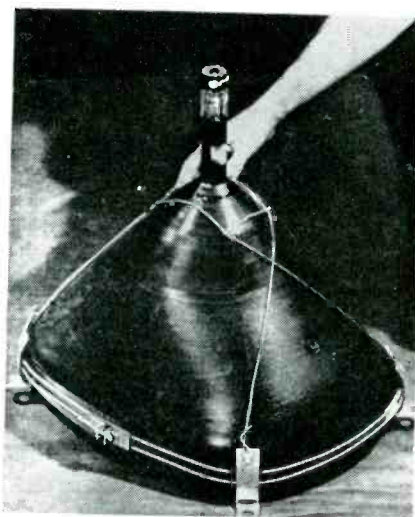

**TV TUBE MOUNT**  
cuts material costs

E. H. TITCHENER & Co., 67 Clinton St., Binghamton, N. Y. A new impact-resistant tv tube mount, fabricated of soft steel wire, costs as low as one-third of conventional mounts. It accelerates tube installation on the assembly line.

During drop tests, where a tv set is dropped from 12 to 30 in. from various positions, this welded wire tube mount holds the tube intact, even after extensive cabinet damage. The soft, zinc-plated wire conforms closely to the tube contour. It will not etch glass, and consequently eliminates the necessity of gasket material previously required to prevent tube implosion or movement.

The mount consists of two parallel contour wires (or one, depending on specifications) for the

**electronic tube corporation**

1200 E. MERMAID LANE

PHILADELPHIA 18, PENNA.



## CHICAGO STANDARD TRANSFORMER CORPORATION

3501 W. ADDISON ST. • CHICAGO 18, ILLINOIS

# SPECIAL NOTICE

*TO OUR MANY ASSOCIATES AND FRIENDS  
IN THE RADIO, TELEVISION AND ELECTRONICS INDUSTRY*

We have been told that there is a rumor being circulated by competitors or others that the Chicago Standard Transformer Corporation has planned, or is planning to sell its assets to outside interests.

Such a rumor is utterly false and unfounded, but has reached us from too many sources to be ignored.

We, therefore, feel compelled to make this public declaration in order to rectify any misconceptions that may have been bred as a result of this misinformation and to "set the record straight."

**The Chicago Standard Transformer Corporation is now, and will remain, as it has since 1928, ready and able to serve this dynamic industry with the finest of transformers, coils, and electronic components. We will continue to develop . . . to engineer . . . and to produce the same top quality products that have earned national respect, and accounted for our continued leadership.**

**CHICAGO STANDARD TRANSFORMER CORPORATION**

tube front, with four lightweight locating stampings and two adjustment stampings. A rear wire support is frequently used to complete the assembly. Circle P48 inside back cover.

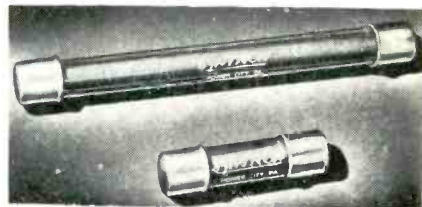

### SELENIUM RECTIFIERS of the cartridge-type

SYNTRON Co., 241 Lexington Ave., Homer City, Pa. The new cartridge-type selenium rectifiers are specifically designed for low-current, high-voltage problems. The miniature rectifier stacks are ideal for use in capacitor storage devices, cable testing, bias supplies, oscilloscopes and G-M counters.

► **Features**—They are rated at 5 ma d-c and feature low leakage current in the reverse direction, low forward drop in the conductive direction and a wide frequency range between 0 and 1,000 cycles per circuit. No filament transformers are needed, no warmup time required.

A vapor deposition process insures uniformity, stability and long life. The cells are securely mounted in a hard glass tube with a helical steel spring at one end to provide contact. Ends of the glass tube are hermetically sealed by metal ferrules using a porcelain-glass-to-metal seal. The ferrules fit the standard 30-ampere fuse clip. Circle P49 inside back cover.

### MIDGET RELAY rugged and dependable

PRICE ELECTRIC CORP., Frederick, Md. A rugged, dependable midget relay—Husky series 1100—is now being produced. It is ideal for communications equipment—railway, automotive, taxi and general purpose use.

Coils of the strong and compact unit are completely sealed against moisture and corrosion resulting

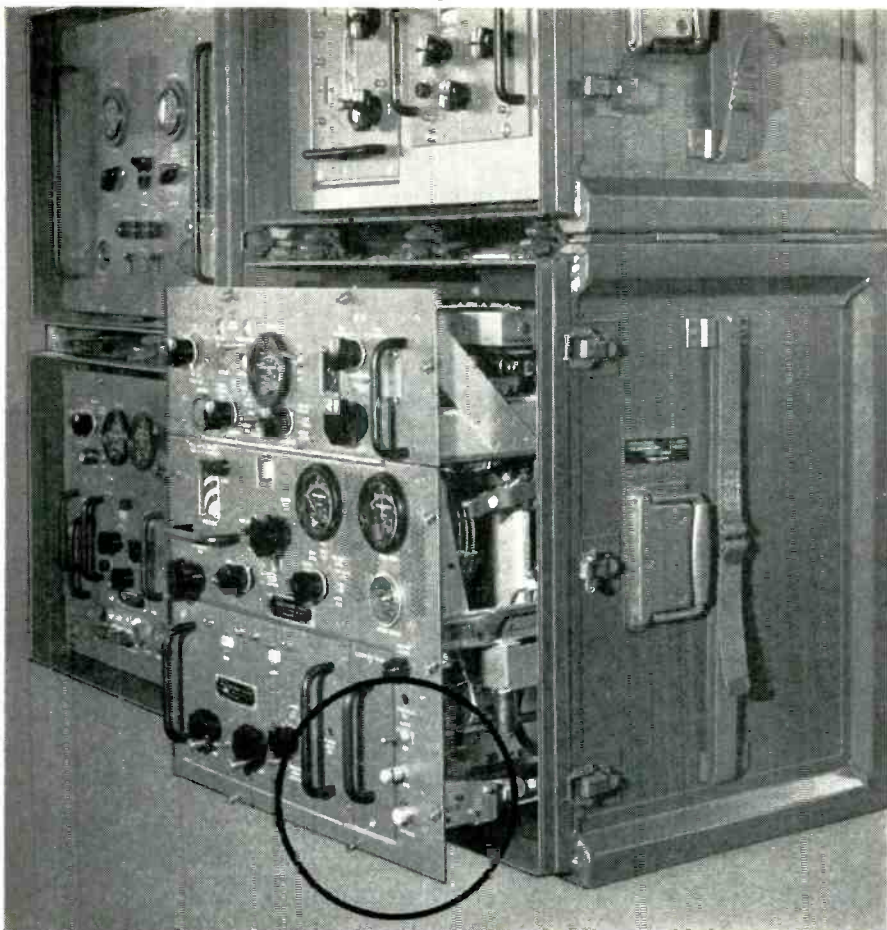

*MicroMatch*  
directional couplers  
monitor ANTRAC  
right... here!

The Army's multi-channel AN/TRC-24 transmitter relies on Micro-Match Directional Couplers for continuous RF Power monitoring and VSWR indication. They give positive confirmation of the transmitter and antenna system's performance.

MicroMatch Directional Couplers give your transmitters these invaluable features at extremely low cost. Their output is essentially independent of frequency over the range of 20 to 2000 megacycles. They are adjusted to produce full scale meter deflection at power levels of 1.2 watts to 120 KW. Accuracy of power measurement is  $\pm 5\%$  of full scale.

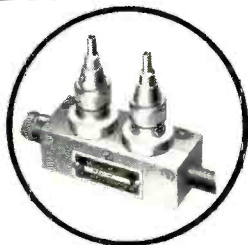

WRITE FOR OUR 50-page catalog.



WHEN MICROMATCH IS BUILT IN—  
YOU KNOW WHAT'S GOING OUT

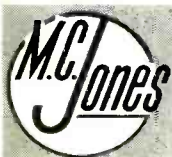

**M. C. JONES ELECTRONICS CO., Inc.**  
BRISTOL, CONNECTICUT



# need quick service on **TIMERS** for automatic control?



Time Delay Timers

The more automatic control problems we get, the better we like it. For while it's true each automatic control job is a bit different from the rest, the record shows that our 19 years of timer experience has given us the special knowledge it takes to give you the right answers, and in near-record time.

If one of our standard timers won't do your job — or one of the 721 combinations we have thus far developed from our 17 basic units — our engineers will go right to work to develop a new combination that's the one for you. That's the way we grow — and we like it.

We manufacture a complete line of timers in these 4 broad classifications:

**TIME DELAY TIMERS • INTERVAL TIMERS  
RE-CYCLING TIMERS • RUNNING TIME METERS**

And since we maintain large stocks of our 17 basic units, we can assure you of rapid deliveries — of excellent deliveries even on special orders. So whatever your automatic control problem, you have everything to gain by submitting it to our timer specialists. They'll give you a profitable answer — almost with the speed of automatic control itself.



Interval Timers

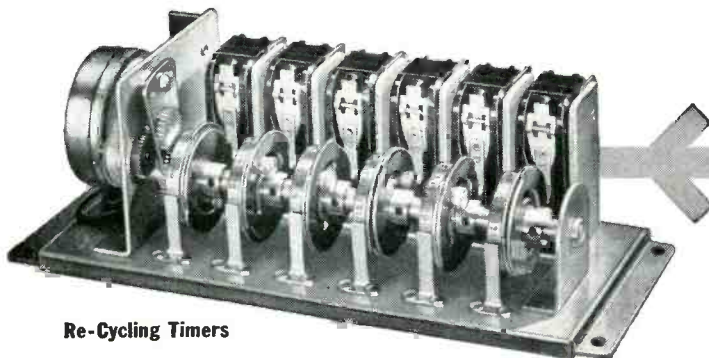

Re-Cycling Timers

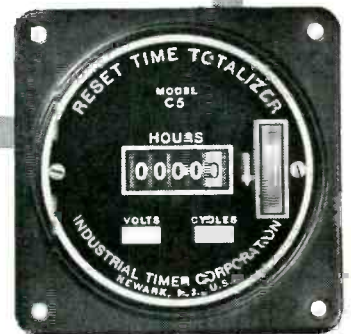

Running Time Meters

*Timers that Control  
the Pulse Beat of Industry*



**INDUSTRIAL TIMER CORPORATION**

1409 McCARTER HIGHWAY, NEWARK 4, N. J.

# NEW KEARFOTT COMPONENTS

FOR LIGHT, MORE RELIABLE  
SERVO SYSTEMS

## SERVO MOTORS

Standard Kearfott servo motors and servo motor-generator combinations are now available for operation with transistorized amplifiers. These units feature center tapped control phase windings rated 40 volts in series and 20 volts in parallel. Fixed phase excitation to size 10 units is 26 volts 400 cps and to size 11, 15 and 18 motors 115 volts 400 cps.

### SUMMARY OF CHARACTERISTICS

Size	Stall Torque	No Load Speed	Watts Phase	Weight
10	.28 oz. in.	6500 RPM	3.1	1.5 oz.
11	.63 oz. in.	6700 RPM	3.5	4.5 oz.
15	1.53 oz. in.	5300 RPM	6	7.30 oz.
18	2.4 oz. in.	5300 RPM	9	12.2 oz.

## AMPLIFIERS

A new transistorized servo amplifier suitable for driving size 10 and 11 servo motors is also available. This amplifier provides a 40 volt, 3 watt output. Designed to meet the requirements of MIL-E-5400 it is rated for operation over the ambient temperature range of  $-54^{\circ}\text{C}$  to  $+71^{\circ}\text{C}$ . A servo type base and a cable with an SM11-20H connector is provided. Dimensions 1 42/64" dia. x 3 25/32" high, weight 8 ozs.

Write Today For Descriptive Technical Data



### KEARFOTT COMPONENTS INCLUDE:

Gyros, Servo Motors, Synchros, Servo and Magnetic Amplifiers, Tachometer Generators, Hermetic Rotary Seals, Aircraft Navigational Systems, and other high accuracy mechanical, electrical and electronic components.

### KEARFOTT COMPANY, INC., LITTLE FALLS, N. J.

Sales and Engineering Offices: 1378 Main Avenue, Clifton, N. J.

Midwest Office: 188 W. Randolph Street, Chicago, Ill. South Central Office: 6115 Denton Drive, Dallas, Texas

West Coast Office: 253 N. Vinado Avenue, Pasadena, Calif.

from high humidity conditions. It can stand up under arctic cold or equatorial heat. Where the relays will be used with high frequencies, special low-loss phenolic insulation is available.

Coils are available for standard d-c voltages from 6 to 110 v d-c. The relay will withstand shock and vibration up to 10 g. Maximum coil resistance obtainable is 11,000 ohms. Capacitance to ground is 3  $\mu\text{mf}$ .

This 2-oz relay has a sensitivity of 2 w d-c. Its fine silver contacts are rated up to 1 ampere at 115 v a-c, noninductive load. Palladium contacts are available rated up to 500 ma at 115 v a-c, noninductive.

The relay can be ordered hermetically sealed. Circle P50 inside back cover.

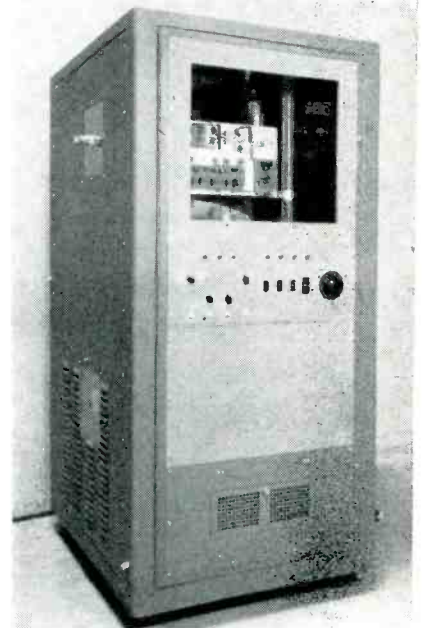

## PULSE MODULATOR high-voltage type

LEVINTHAL ELECTRONIC PRODUCTS, INC., 2760 Fair Oaks Ave., Redwood City, Calif. Model PC40 pulse modulator, when used with an appropriate h-v d-c supply, provides up to 50-kv positive output pulses. Pulse width is continuously variable from 5 to 200  $\mu\text{sec}$  at repetition rates up to 1 kc. Both pulse width and repetition rate are controlled continuously by knobs located at ground level. Pulse rise and pulse fall times are both 1  $\mu\text{sec}$  independent of pulse

# FERRITES—a milestone in communications engineering!

In today's communications engineering, ferrites are ranked with transistors in importance. Ferrites, modern cousins of the ancient lodestone, have more than doubled the efficiency of radar and microwave operations.

The ferrites are magnetic but, unlike natural ferromagnetic materials they resist electrical current. Replacing one of the iron oxide molecules in the lodestone formula with the oxide of any one of a number of metals results in a product which is similar in chemical and crystal structure to the lodestone but is resistant to electric current.

A few of the achievements for these strange new substances are:

1. *Simultaneous sending and receiving on a single microwave antenna.*
2. *Full-power transmission in microwave ranges with no power loss or interference.*
3. *Elimination of frequency drifts in microwave transmission.*

This new group of solid state materials makes possible the continuous search by radar, instead of the intermittent "pulse" sending and receiving of World War II. To fully understand all the implications and probable uses for ferrites, reserve your copy of this special October *Proceedings of the IRE* ferrites issue. It will take its place in the history of radio-electronics along with the transistor issue of November, 1952, and the solid-state electronic issue of December, 1955. You will want to read and refer to it for years to come!

## SPECIAL OCTOBER ISSUE CONTAINS 27 IMPORTANT ARTICLES ON FERRITES:

- "Resonance Loss Properties of Ferrites in the 9KMC Region" by S. Sensiper, Hughes Aircraft Co.
- "Magnetic Resonance in Ferrites" by N. Bloembergen, Harvard Univ.
- "Methods of Preparation and Crystal Chemistry of Ferrites" by Donald Fresh, Bureau of Mines
- "Topics in Guided Wave Propagation in Magnetized Ferrites" by Morris L. Kales, Naval Research Lab.
- "Frequency and Loss Characteristics of Microwave Ferrite Devices" by Benjamin Lax, Lincoln Lab., MIT
- "The Non-Linear Behavior of Ferrites at High Microwave Signal Levels" by H. Suhl, Bell Telephone Laboratories
- "Dielectric Properties and Conductivity in Ferrites" by L. G. Van Uitert, Bell Telephone Laboratories
- "The Elements of Non-Reciprocal Microwave Devices" by C. L. Hogan, Harvard Univ.
- "Fundamental Theory of Ferro- and Ferri-Magnetism" by J. H. Van Vleck, Harvard
- "Ferrites as Microwave Circuit Elements" by G. S. Heller, MIT
- "Radiation from Ferrite-Filled Apertures" by D. J. Angelakos, Univ. of Calif., Berkeley, Calif.
- "Anisotropy of Cobalt-Substituted Mn Ferrite Single Crystals" by P. E. Tannenwald and M. H. Seavey, MIT
- "Birefringence of Ferrites in Circular Waveguide" by N. Karayianis and J. C. Cacheris, Diamond Ordnance Fuze Labs., Washington, D. C.
- "Ferrite-Tuned Resonant Cavities" by C. E. Fay, Bell Telephone Laboratories
- "Ferrite Tunable Microwave Cavities and the Introduction of a New Reflectionless Tunable Microwave Filter" by Conrad E. Nelson, Hughes Aircraft Co.
- "Permeability Tensor Values from Waveguide Measurements" by E. B. Mullen, G. E., Syracuse
- "A New Ferrite Isolator" by B. N. Enander, RCA Labs.
- "Ferrite Directional Couplers" by A. D. Berk and E. Strumwasser, Hughes Aircraft Co.
- "Intrinsic Tensor Permeabilities on Ferrite Rods, Spheres, and Disks" by E. G. Spencer, L. A. Ault, R. C. LeCraw, Diamond Ordnance Fuze Labs., Washington, D. C.
- "Magnetic Tuning of Resonant Cavities and Wideband Frequency Modulation of Klystrons" by G. Jones, J. C. Cacheris, C. Morrison, Diamond Ordnance Fuze Labs.
- "Microwave Resonance Relations in Anisotropic Single Crystal Ferrites" by J. O. Ortman, Harvard Univ.
- "Anomalous Propagation in Ferrite Loaded Waveguide" by H. Seidel, Bell Telephone Laboratories



The Institute of Radio Engineers

1 East 79th Street • New York 22, N. Y.

### PROCEEDINGS OF THE IRE

1 East 79th Street, New York 21, N. Y.

Enclosed is \$3.00

Enclosed is company purchase order for the October, 1956 issue on FERRITES.

Send to:

Name \_\_\_\_\_

Company \_\_\_\_\_

Address \_\_\_\_\_

City & State \_\_\_\_\_

All IRE members will receive this October issue as usual.

Extra copies to members, \$1.25 each (only one to a member).

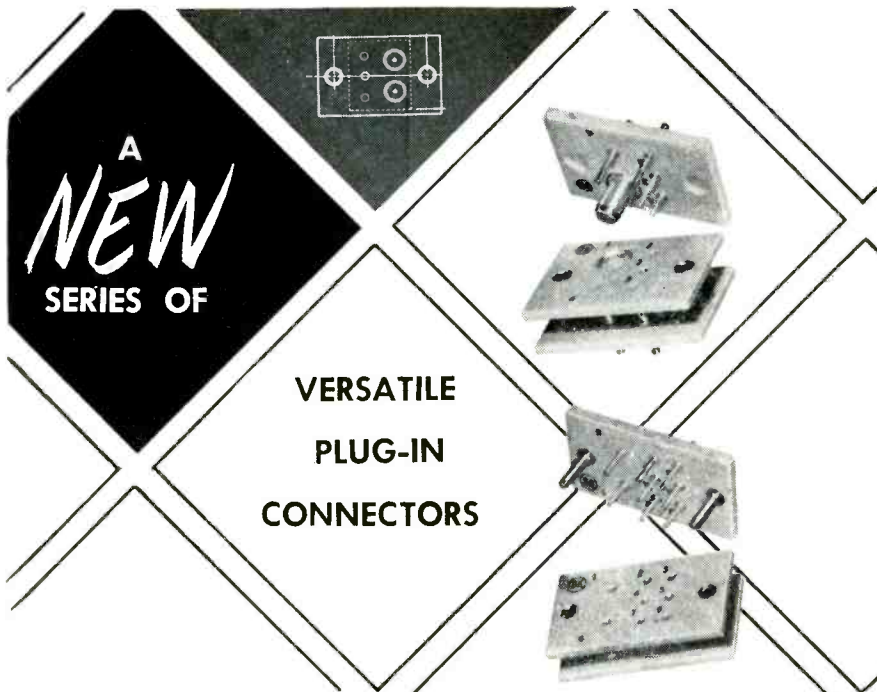

*Easy action precision machined contacts . . . Guide pin or machine screw mounting . . . Coax for new miniature cables . . . Full floating female contacts . . . High strength insulators . . . Rugged Design . . . Small size . . .*

The standard series of connectors is offered in five sizes with various combinations of 3 to 17 power contacts and one or two coaxial contacts. The power contacts have an 8 ampere rating and a minimum sea level flashover voltage of 3500 volts RMS. The insulators are a new high strength polyester melamine laminate that has good arc resistance and low moisture absorption. The coaxial contacts are approximately 50-ohms impedance and generally satisfactory for frequencies up to 1,000 mc. Clamping parts, that require no soldering of the braid wires, are available in various sizes for coaxial cables from 1/16 OD up to 1/4 inch for RG-59/U etc. cables.

The basic connectors are supplied for standard machine screw mounting. A Guide Pin and Bushing Kit GK-1 is available that adapts the standard connectors to guide pin engagement and mounting. Cover and cable clamp assemblies are available for hand engagement of the connectors in patch cord or test applications.

The design of the connector parts is such that the pin and socket contacts, coaxial contacts, insulator, and guide mountings can be arranged to make practically any shape or size of connector. The flat insulators do not require molds. Therefore special shapes and combinations can be supplied promptly without special tooling charges.

In addition to the standard types, the parts are available separately. These parts can be readily assembled into special connectors by merely drilling standard size holes in the insulator plates and assembling the component parts.

*Write or call for descriptive folder.*

**DANBURY  KNUDSEN**  
INCORPORATED  
DANBURY, CONN.

length. Sag on the flat top of the pulse is determined primarily by the size of the output filter-capacitor used in the h-v power supply.

This pulse modulator was designed primarily to operate into a high-impedance load. Nominal load impedance is 1 megohm shunted by 25  $\mu\text{f}$ . The equipment includes a floating deck which is tied to the modulating anode and switched to ground by an appropriate 50-kv tetrode. It also includes a buffer deck connected to the h-v supply and used to bring the pulse back down by a h-v tetrode which clamps the floating deck to the buffer deck.

► **Further Data**—Also included is an internal trigger generator for determining pulse length and repetition rate. All important wave forms in the system are fed to a monitor selector switch on the front panel for presentation on an oscilloscope. Total power requirements of the system are 2 kw from a 120-v 50/60-cps source. **Circle P51 inside back cover.**

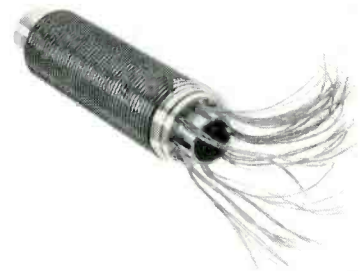

### TEFLON LEAD WIRE for high temperature use

HITEMP WIRES, INC., Mineola, N. Y. Capable of continuous operation up to 500 F, the new Teftlon lead wire remains extremely stable, in that it does not give off corrosive vapors when subjected to various adverse conditions such as corrosive solvents and chemicals, sunlight and high temperatures.

Where lead wire is permanently fixed in a component, such as in the slip ring assembly illustrated, costly scraping due to soldering damage as well as high molding temperatures is eliminated.

Available in 12 to 32 Awg, in solid or spiral striped color cod-

# New! 5 ACCURATE Q STANDARDS

for frequency coverage from 50 KC to 50 MC

Type 518-A

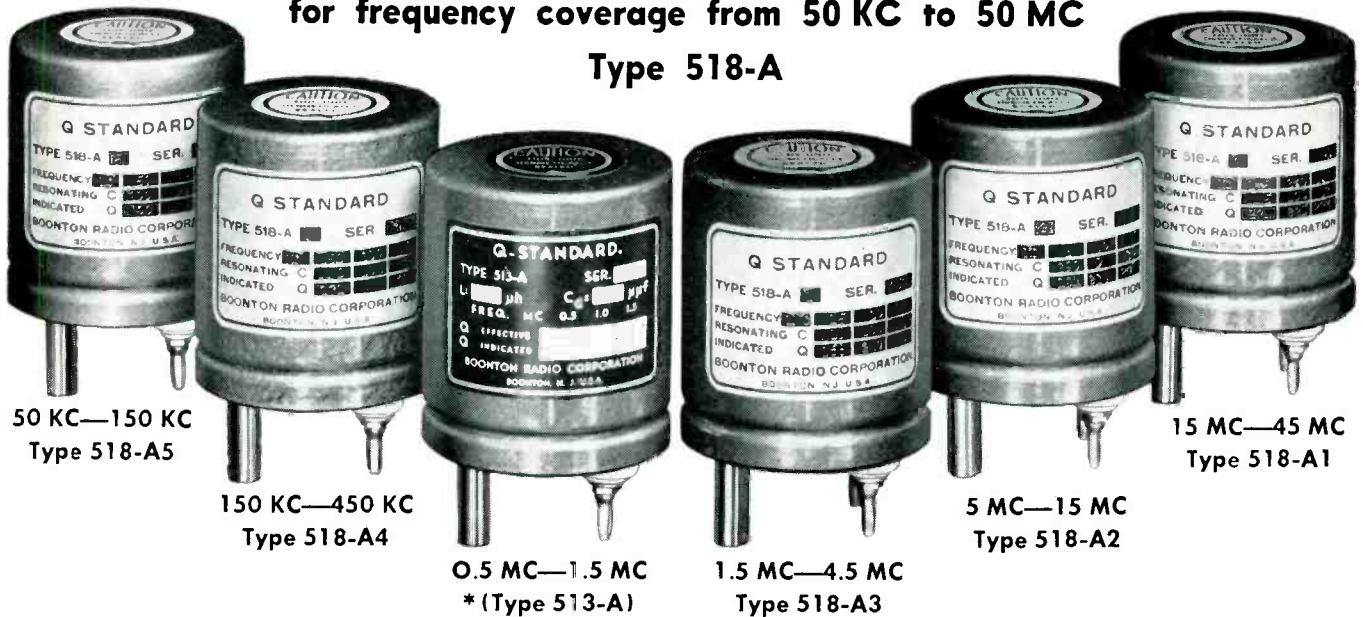

Supplementing the well-received Q Standard Type 513-A, BRC has designed five additional Q Standards Type 518-A. Similar in construction and performance to the 513-A, these Standards, in conjunction with the 513-A, provide fre-

quency coverage from 50 KC to 50 MC — the entire range of Q-Meter Type 260-A. The units are useful as precision inductors and as a fast, convenient method for checking the overall operating accuracy of Q Meters.

INDUCTANCE	518-A1	518-A2	518-A3	518-A4	518-A5
	0.25 $\mu$ h	2.5 $\mu$ h	25 $\mu$ h	2.5 mh	25 mh
Low Freq. Data:					
Frequency	15 MC	5 MC	1.5 MC	150 KC	50 KC
Resonating C	420 $\mu$ uf	395 $\mu$ uf	440 $\mu$ uf	440 $\mu$ uf	400 $\mu$ uf
Indicated Q	175	195	175	170	90
Middle Freq. Data:					
Frequency	30 MC	10 MC	3 MC	300 KC	100 KC
Resonating C	100 $\mu$ uf	95 $\mu$ uf	105 $\mu$ uf	100 $\mu$ uf	85 $\mu$ uf
Indicated Q	235	235	225	180	130
High Freq. Data:					
Frequency	45 MC	15 MC	4.5 MC	450 KC	150 KC
Resonating C	40 $\mu$ uf	40 $\mu$ uf	45 $\mu$ uf	40 $\mu$ uf	35 $\mu$ uf
Indicated Q	225	205	230	135	125

(Table shows nominal values)

\*Nominal values for Type 513-A

	L - 250 $\mu$ h			Cd - 8 $\mu$ uf		
	0.5 mc	1.0 mc	1.5 mc	0.5 mc	1.0 mc	1.5 mc
$Q_e$	190	250	220	190	250	220
$Q_i$	183	234	200	183	234	200

PRICES:

Type 518-A \$60.00 ea.  
 Type 513-A \$75.00 ea.  
 Set of five Type 518-A and one 513-A \$350.00

F.O.B. Boonton, New Jersey

**BOONTON**  
**RADIO**  
**CORPORATION**



Boonton, New Jersey

ings, the lead wire meets MIL-W-16878 type E and EE specifications. Circle P52 inside back cover.

## SYNTHETIC MICA in powder and sheet form

MYCALEX CORP. OF AMERICA, P. O. Box 311, Clifton, N. J. Synthamica synthetic mica is now available in quantity for industrial application.

Four forms of the material are currently offered: Synthamica 202, a high quality, synthetic fluor-phlogopite mica in flake or powder form; Synthamica 707, a bonded, inorganic punching material, 0.005 in. to 0.100 in. in thickness; Synthamica 727, flexible, inorganic bonded material for creating formed parts to be heat cured; Synthamica 807, reconstituted mica paper sheets with no binder.

Synthamica is true mica—a chemically pure synthetic fluor-phlogopite mica capable of withstanding sustained temperatures as high as 2,000 F without physical or electrical failure. Circle P53 inside back cover.

**ENGINEERS AND PHYSICISTS** often find their professional careers slowed down to a proverbial "snail's pace," at the same time, paradoxically, that they are working on problems involving lightning-like calculations and supersonic speeds...

### GO FASTER WITH LIBRASCOPE

We are interested in experienced engineers concerned with:

ANALOG COMPUTERS  
DIGITAL COMPUTERS  
LOGICAL DESIGNS  
FIRE CONTROL SYSTEMS  
SERVOMECHANISMS  
OPTICS  
TRANSISTOR PULSE  
CIRCUITRY  
MAGNETIC MEMORY  
TECHNIQUES

Strong subsidiary benefits—autonomous engineering divisions where you are close to management—see your projects through to completion.

**HOW FAST  
ARE YOU  
PROGRESSING?**

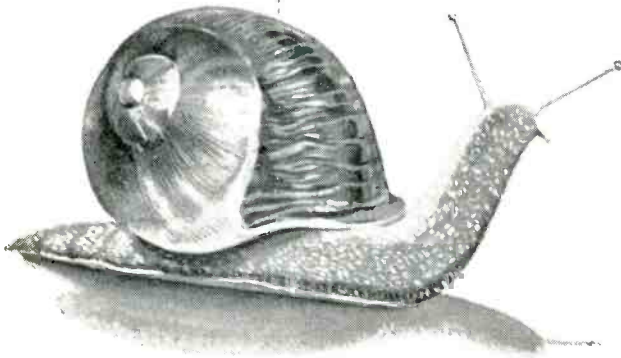

A SUBSIDIARY OF



**LIBRASCOPE**

LIBRASCOPE INC. 808 WESTERN AVE.  
GLENDALE, CALIF.

Members and visitors  
to WESCON are cordially  
invited to **LOS ANGELES**

**INTERVIEWS:** Tues. Aug. 21 • Wed. Aug. 22 • Thurs. Aug. 23

Ask for **GLEN SELTZER** — Employment Manager  
**AMBASSADOR HOTEL**

or write to: **DON WEBSTER**, Chief Engineer

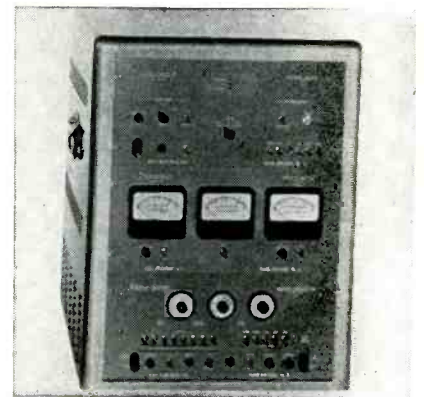

## TRANSISTOR ANALYZER priced at \$990

KAY ELECTRIC Co., 14 Maple Ave., Pine Brook, N. J., has announced the Transalyzer, a new instrument to measure alpha and alpha cutoff characteristics of point contact, junction and tetrode transistors. Provided by the instrument are a sweep generator, attenuators, d-c biasing and metering circuits for the transistor, and an r-f ampli-

# *In Parts Like These...*

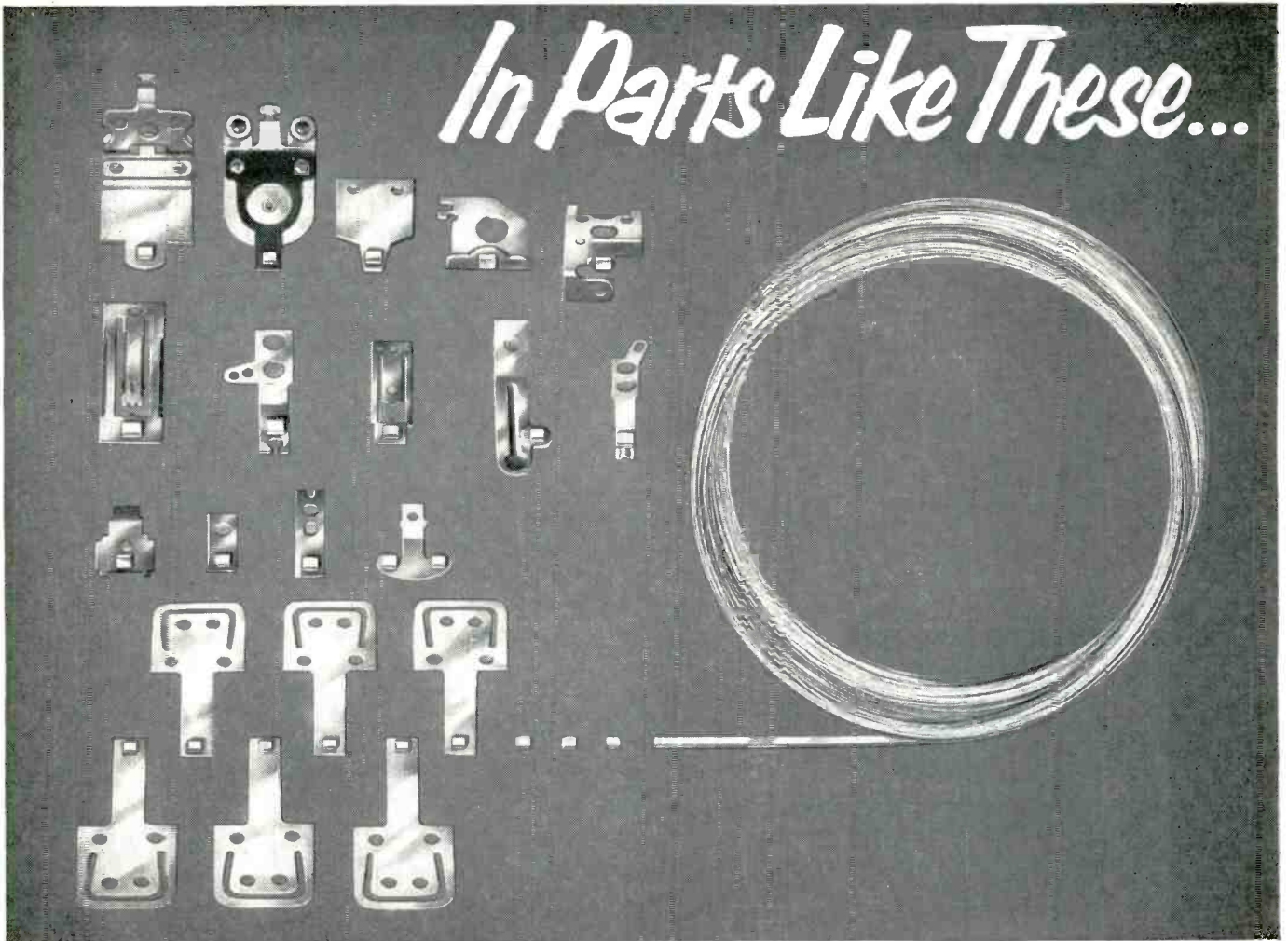

## **GENERAL PLATE...**

### **Clad Electrical Contact Tapes**

**Reduce Costs, Minimize Assembly Operations,  
Permit Miniaturization and Improve Performance**

Included among the many advantages offered by the use of General Plate Clad Electrical Contact Tapes are assembly accuracy, change-over ease, design freedom, *plus* immediate and substantial cost reductions, performance improvements, miniaturization and standardization.

Basically, electrical contact tape consists of an electrical contacting face of desirable composition and contour plus an elevated or serrated backing of readily electro-weldable material. The serrated back makes possible a larger weld area assuring much greater thermal and electrical conductivity from the contact to backing member assuring exceptional performance.

The contact face is available in practically any ductile contact material either as a single metal or clad to another metal. Contact backing or supporting materials are available in steel, brass, copper, phosphor bronze, beryllium copper, nickel or monel, and aluminum.

Why not find out how you can benefit with General Plate Clad Electrical Contact Tapes? Write for complete information, or better still, ask for a General Plate Engineer, who will gladly help you with your contact problems.

***You can profit by using  
General Plate Composite Metals!***

**METALS & CONTROLS CORPORATION  
GENERAL PLATE DIVISION**

1310 FOREST STREET, ATTLEBORO, MASSACHUSETTS

# ANNOUNCING

## For Production of Ultra-Pure Water

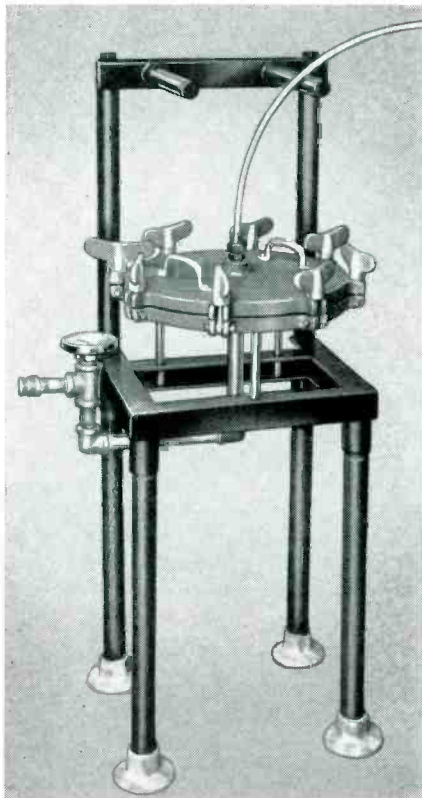

### THE BARNSTEAD MF SUBMICRON FILTER

*Removes Particles  
to 0.45 micron  
(.000016 in.)*

Here is a new Barnstead aid for the production of extremely pure water . . . a filter that removes sub-microscopic particles from distilled or demineralized water. This new filter

permits on a production basis an ultra-fine filtration heretofore possible only on a small laboratory scale. The MF Submicron Filter provides positive filtration to 0.45 micron. It removes bacteria. Removal of the submicroscopic particulate matter from the pure water assures better results in work with semi-conductors, transistors, charactron tubes, condensers, reactor components, high resistance cooling systems etc.

Employs replaceable Millipore filtering membrane. Capacities: 100 to 500 or more gallons per hour.

Write for Bulletin 141 for full details on production of water with resistance of 10,000,000 ohms or more, and free of organics, bacteria, and particulate matter.



84 Lanesville Terrace, Boston 31, Mass.

*Since 1878 — Stills & Demineralizers For Every Pure Water Need*

fier and detector. The sweeping oscillator may be used independently of transistor test circuitry. All transistor biases are electronically regulated. An oscilloscope is the only auxiliary equipment necessary for measurement.

► **Specifications**—The 50 kc to 50 mc sweeping oscillator has an r-f output of 1.0 v peak-to-peak into nominal 70 ohms; flat within  $\pm 0.5$  db over widest range. Sweep width is continuously variable, 2.5 to 50 mc. Center frequency may be set anywhere in the 50 kc to 50 mc range. Specifications for the biasing and metering circuit and the r-f amplifier are available on request. **Circle P54 inside back cover.**

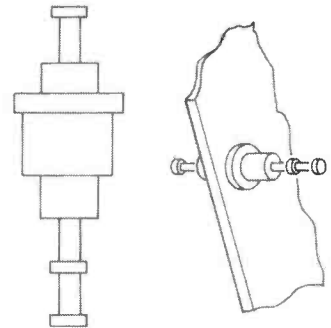

### INSULATED TERMINAL for chassis mounting

LERCO ELECTRONICS, INC., 501 South Varney St., Burbank, Calif., has introduced a new insulated feed-through terminal which may be mounted directly on a metal chassis where no room is available for terminal board. Using a high electrical grade of melamine for insulation, the terminals mounted on metal chassis have withstood breakdown tests in excess of 1,500 v.

The new terminals may be swaged directed onto the metal part without warpage. Because they are completely rigid when mounted, they will withstand heavy shock without causing noise problems.

Both models 6065 and 6066 use the MME insulated material, and are available for board thicknesses of  $\frac{1}{8}$  to  $\frac{3}{8}$ . Model 6065 has a double tie on one end; model 6066, a double tie on both ends. They are



***The right people  
with the right facilities  
produce the right solutions***



The new Sylvania Microwave Physics Laboratory, Mountain View, California.



Results of gaseous electronics investigation concerned with wide-band tunable microwave oscillations are examined at the Microwave Physics Laboratory. From left: Laboratory Manager, O. T. Fundingsland; Dr. R. M. Hill, senior project leader, gaseous electronics; Dr. P. H. Vartanian, senior project leader, ferrites; and Dr. A. L. Aden, assistant laboratory manager.

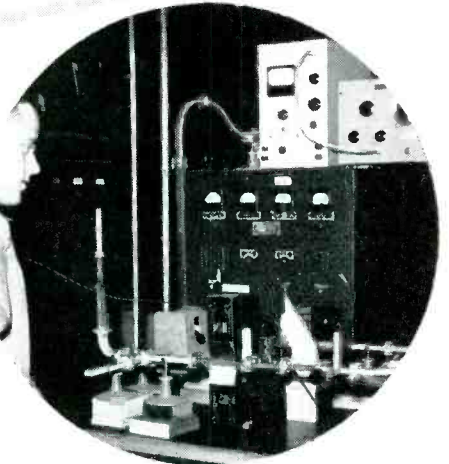

Frequency doubling in ferrites, a phenomenon newly discovered at Sylvania Mountain View laboratories, is studied by engineer A. L. Helgesson.

## **More problem-solving power... Sylvania's new Microwave Physics Laboratory**

NEW PROBLEM-SOLVING POWER has been added to Sylvania's growing capability for research and development in highly advanced military and industrial electronic systems.

With the establishment of the Microwave Physics Laboratory at Mountain View, Calif., Sylvania is expanding its work in new magnetic materials and ionized gaseous media for microwave electronic control devices and systems

for radar, communications, and electronic countermeasures.

Fields of research at the laboratory include magnetic ferrites, gaseous electronics, radio wave propagation, electromagnetic resonance phenomena in ferrites and ionized gaseous media.

Besides the new Microwave Physics Laboratory, the Microwave Tube Laboratory and the Electronic Defense Laboratory are also located at Mountain

View. Each is a vital part of Sylvania's Electronic Systems Division.

In addition to the Mountain View laboratories, the Electronic Systems Division has plant and laboratory facilities at Buffalo, New York, and extensive research facilities at Waltham, Massachusetts. All are staffed with top-ranking scientists and engineers, backed by Sylvania's extensive resources in the electronics field.

### **SYLVANIA IS LOOKING FOR ENTERPRISING ENGINEERS**

*Sylvania has many opportunities in a wide range of defense projects. If you are not now engaged in defense work, you are invited to contact Edward W. Doty, Manager of Personnel, Electronic Systems Division, Sylvania Electric Products Inc., 100 First Avenue, Waltham 54, Mass.*



**LIGHTING • RADIO • ELECTRONICS • TELEVISION • ATOMIC ENERGY**

*See Sylvania at the Annual Symposium on Aeronautical Communications, Oct. 8, 9, 10, Hotel Utica, Utica, N. Y., Booth 9*

# Celco TOROIDS

... Offered in a  
wide range of sizes

#50 wire on .062" ID  
#15 wire on 9" OD



Whether it's a complex 10 winding magnetic amplifier or a simple choke . . . at Celco each toroid is precision-made. New core materials are used in Toroidal magnetic amplifiers, reactors and transformers to achieve maximum performance.

At Celco, the proper matching of cores, winding, handling, impregnation, encapsulation and electrical history of the final assembly is carefully controlled to maintain the original design characteristics.

Our years of design, development, and production know-how are available for application to your specific **TOROIDAL** problems.

For immediate attention, call **RAMsey**  
9-1123 — or write today.



## Celco

*Constantine*  
*Engineering Laboratories Co.*

MAHWAH, N. J.  
RAMsey 9-1123



Your plant is only hours away by the **Celco Air Fleet!**

also available on order to any specifications. Circle P55 inside back cover.

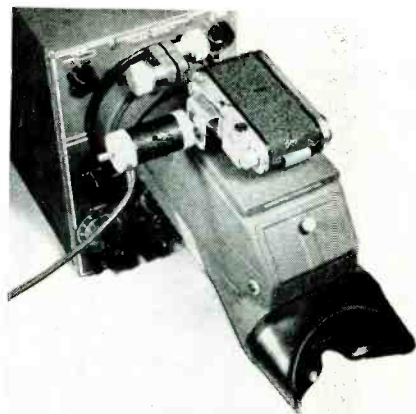

### CRO RECORD CAMERA for single frame recordings

ALLEN B. DUMONT LABORATORIES, INC., 750 Bloomfield Ave., Clifton, N. J., has announced an oscillograph record camera for single frame recordings which automatically advances film frames in rapid sequence, at random, or at synchronized intervals. Type 352 oscillograph record camera incorporates a self-contained spring motor which advances automatically 1 to 24 film frames.

Featuring a 7-element Wollensak f/1.5-50 mm lens, it is capable of recording exceedingly high writing rates. The type 352 uses standard 35 mm film and offers simultaneous binocular viewing and recording. An illuminated data card permits pertinent information to be printed directly on the film record. The solenoid adapter enables remote control of the shutter action. Circle P56 inside back cover.



### D-C POWER SUPPLY with fast response

DRESSEN-BARNES CORP., 250 N. Vinedo Ave., Pasadena, Calif., announces regulated d-c power sup-

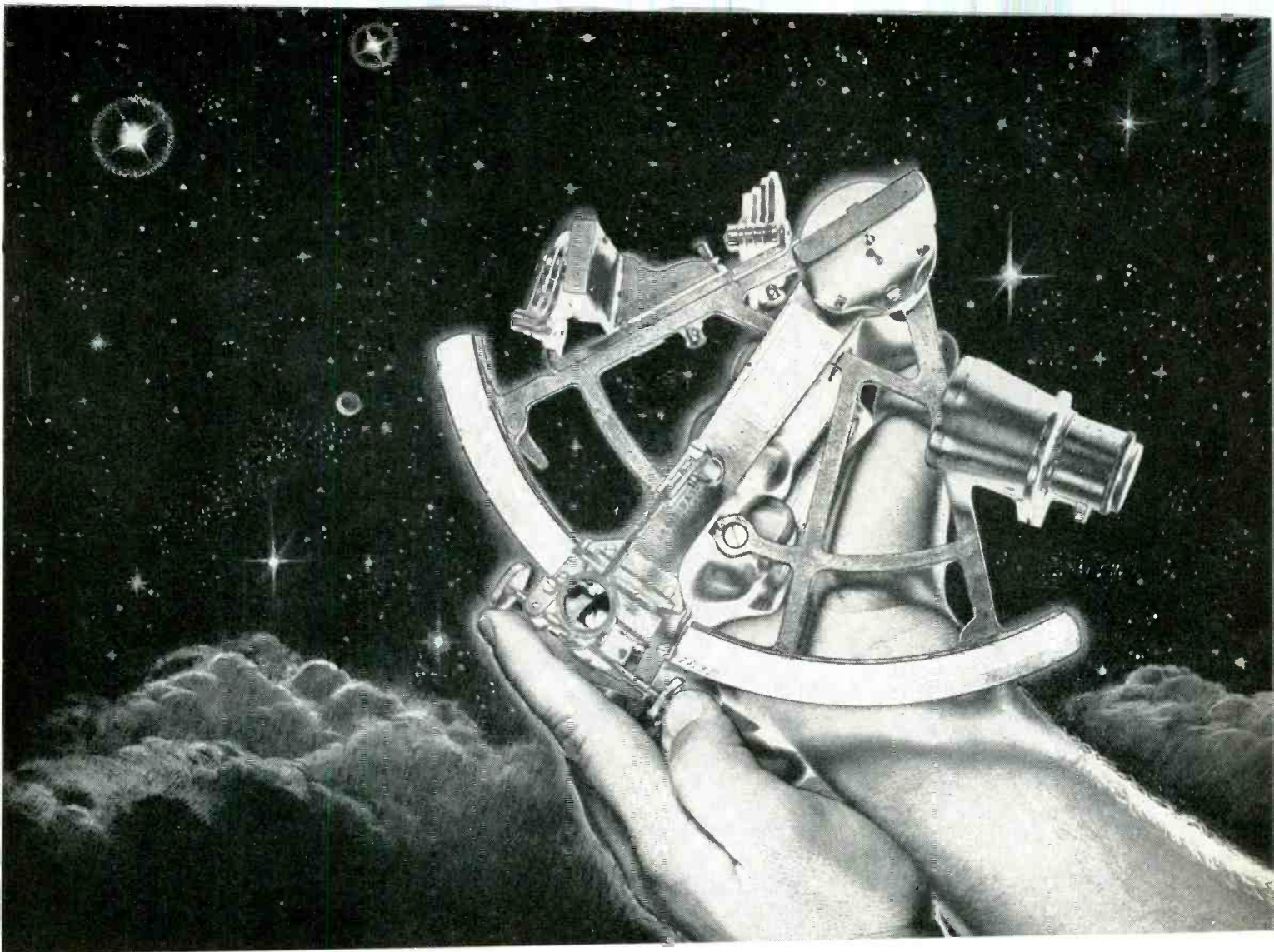

# UNIVAC<sup>®</sup> and your stars...



What are you shooting for in the vast universe of opportunity? Remington Rand UNIVAC has a majority of the top men in computer development... men who brought into being the basic knowledge in this field... who set the standards others follow... and who consistently lead in design trends today. These men will share their know-how wisely with you.

## UNIVAC offers permanent positions in Electro-Mechanical Engineering • Design • Product Design

**MECHANICAL ENGINEERS:** Graduates BS and MS levels. For development of automation instruments... computer input and output mechanisms... memory devices. Includes paper and magnetic tape handling equipment, punched card equipment, printers, magnetic storage drums, and machine design in mechanical and electro-mechanical fields.

**DESIGNERS:** With or without formal degrees if qualified. Here are the foremost opportunities to achieve full stature in small mechanisms work. Includes diversifications of both mechanical and electro-mechanical equipment.

Remember, "*Limits for advancement are set by you alone at Remington Rand UNIVAC.*" The finest educational programs are financed, salaries are commensurate with abilities, employee benefits are complete in all details.

Send Complete Resumé to

***Remington Rand Univac***

DIVISION OF SPERRY RAND CORPORATION

Dept. NO-2

WILSON AVENUE • SOUTH NORWALK, CONNECTICUT

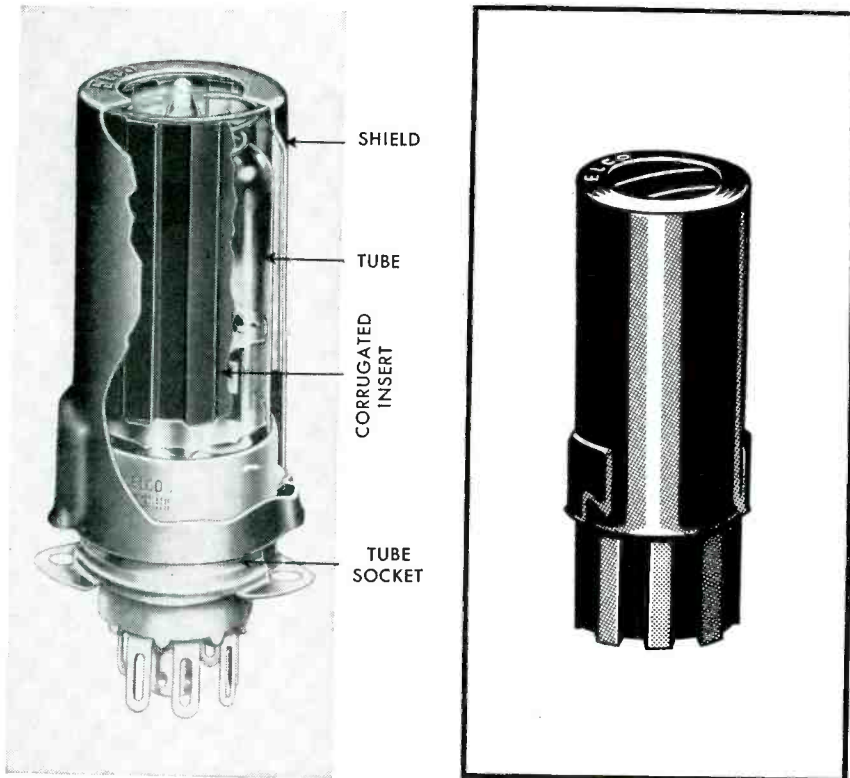

### ELCO'S Corrugated JAN Shield Inserts

(with Exclusive Elcodized Finish)

for reducing miniature tube temperatures

Because high temperature is detrimental to tube life, the use of Elco's corrugated shield-inserts result in greatly reduced operating temperatures — thus effecting fewer tube failures; less down-time; less maintenance; greater tube economy and reliability.

Heat is conducted by insert from tube envelope to shield. Maximum radiant heat is afforded by specially blackened surface (our exclusive Elcodized finish). Corrugated insert construction provides greater surface for heat dissipation by convection.

Standard Elco corrugated JAN shield inserts are made of 0.003" beryllium copper, cadmium plated; and chemically treated with Elcodized black matte finish. Other materials and thicknesses furnished upon request. Inserts are easily adaptable to standard JAN shields and sufficiently resilient to accommodate variations in tube diameters. Finish is both electrically and thermally conductive, and treated to withstand 48-hour salt spray test per QQ-M-151a. Same degree of electrostatic shielding is maintained as with JAN shield. Further heat dissipation may be effected by use of Elco JAN type cadmium plated and blackened shields.

Six sizes are available to fit the six sizes of JAN type tube shields.

Effectiveness of corrugated inserts for heat dissipation is confirmed by investigation of electron tube bulb temperatures at U. S. Naval Electronics Laboratory and recorded in N. E. L. Reliability Design Handbook. See Section 200, Pages 7 to 24; and Section 502, Pages 3 and 4. Our Bulletin No. 104 gives further data and specifications relative to this newsmaking and newsworthy Elco product. Yours upon request on your company letterhead.

For Descriptive Bulletin, Prices, Etc., Write, Phone, Wire  
**ELCO CORPORATION, M BELOW ERIE, PHILADELPHIA 24, PA., CU 9-5500**

ply especially engineered for high-current applications requiring fast recovery time. A 1½-ampere unit, its response is 0.4 millisecond n-l to f-l; 0.25 millisecond f-l to n-l, enabling use with computers, and quick-response laboratory and industrial applications.

Designed as model 3-1.5MB, the unit supplies 0 to 300v d-c at 1½ amperes, continuously variable without switching. It supplies a variable bias voltage of 0 to 145/155v d-c at 5 ma, and an external 6.3 v a-c output at 10 amperes. High-voltage output is floating, and may be used as either a positive or negative source.

Complete specifications and literature will be sent on request. Circle P57 inside back cover.

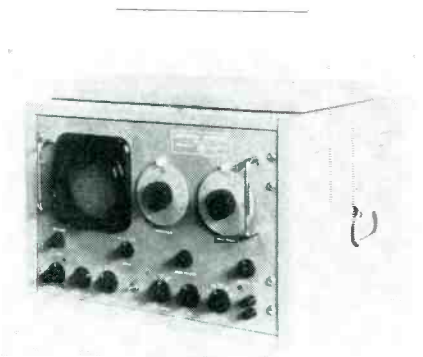

### SPECTRUM ANALYZER wide-band type

PROBESCOPE Co., 44-05 30th Ave., Long Island City 3, N. Y., announces a 0-100 kc wide-band spectrum analyzer. Model SS-100 analyzer will give an instantaneous fourier analysis of noise vibration and harmonics with special application in the telemetering, aircraft, filter, acoustic and medical fields.

► **Highlights**—Special features include an automatic optimum resolution, bandpass input filter continuously variable center frequency and sweep width controls, front end overload protection, a flat faced 5-in. crt, and camera mount bezel.

Specifications include: frequency, 13.5 cps to 110 kc; sweep width variable from 200 cps to 20 kc; resolution to 27 cps; a 60-db dynamic range; linear and 3 decade log voltage scale with a ±1 db accuracy, and a 500μv to

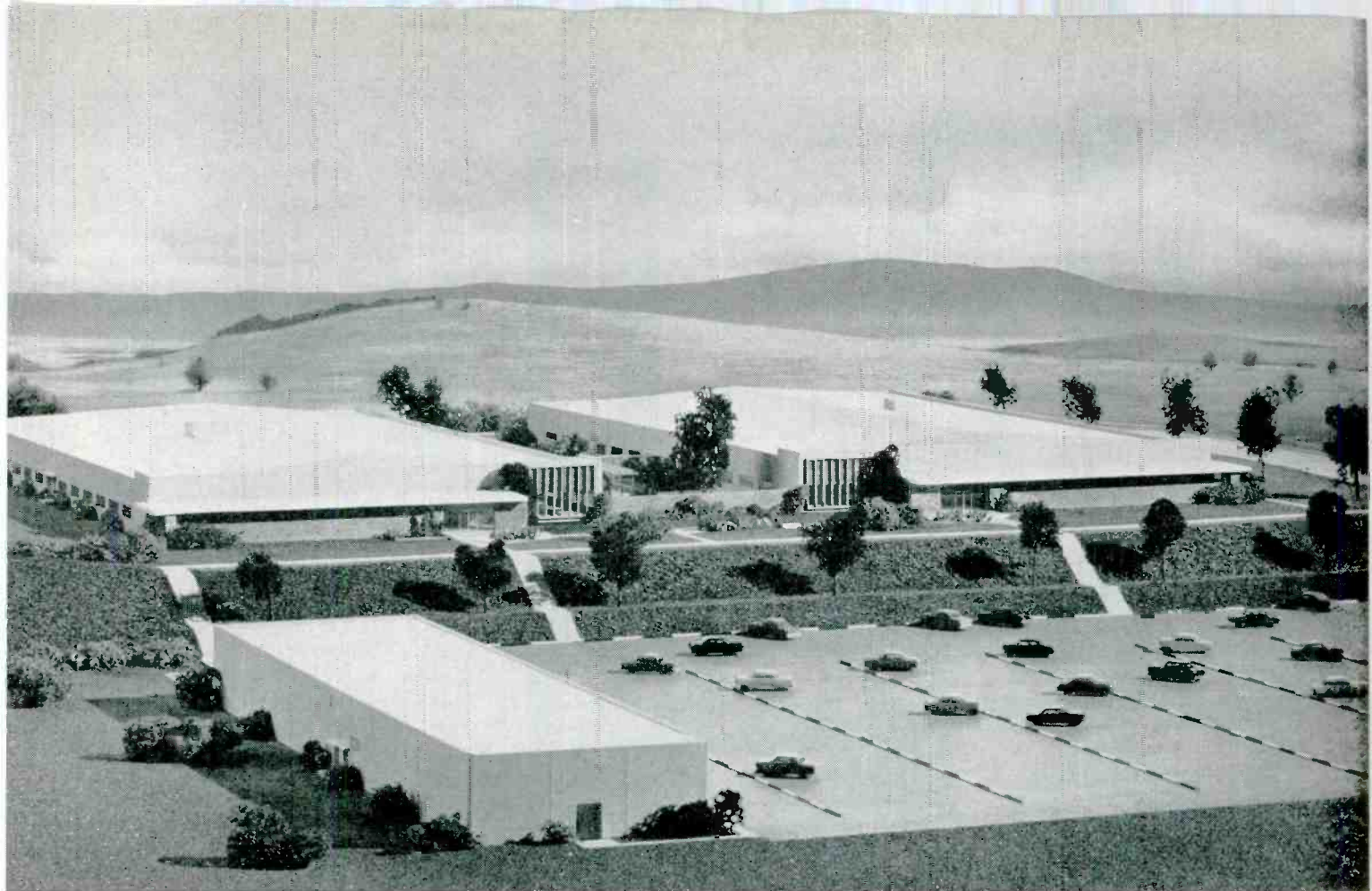

SCALE MODEL, NEW LOCKHEED RESEARCH CENTER AT PALO ALTO, CALIFORNIA  
Here scientists and engineers are now working in modern laboratories on a number of highly significant projects.

## LOCKHEED DEDICATES NEW RESEARCH CENTER

Scientists and engineers are now performing advanced research and development in their new Lockheed Research Center at Stanford University's Industrial Park, Palo Alto, California. In recent ceremonies marking its completion, the Research Center was dedicated to scientific progress.

First step in a \$20,000,000 expansion program, it provides the most modern facilities for scientific work related to missiles and space flight. Significant activities are already being carried on in more than 40 areas, including upper-atmosphere problems, nuclear physics, hypersonic aerodynamics, use of new and rare materials, propulsion and advanced electronics.

Lockheed's expansion program has created positions on all levels for scientists and engineers in virtually every field of missile technology. Inquiries are invited from those possessing a high order of ability.

*Lockheed*

**MISSILE SYSTEMS DIVISION**

*research and engineering staff*

LOCKHEED AIRCRAFT CORPORATION

VAN NUYS • PALO ALTO • SUNNYVALE

CALIFORNIA

# BAM!

and there's your ring  
in just  
**1 STROKE!**



This basic ring — with the flange outside and close tolerance inside — had to be made in tremendous quantities for military use.

It could have been "hogged" or machined out of a bar, tube or forging . . . at great expense. But we at Presteel knew it could be **stamped**.

Backed by 73 years' experience in stamping, our engineers designed unique tools. Our process called for blanking and drawing, redrawing, piercing the bottom and final forming; the latter in our 1500 ton press.

**BAM!** In just one stroke, the blank sleeve became the finished ring — **untouched by a machine tool!**

It is obvious what happened to costs. Close tolerances were held; there were no locked-in stresses. Maybe you can apply this principle to a part you use. Stampings start with uniform sheet metal, but they can wind up in multiple shapes and thicknesses, and get rid of slow operations and unnecessary \$\$\$.

Bring us **your** toughest pressing problem — let us **solve** it with a saving stroke,

## WORCESTER PRESSED STEEL COMPANY



Get a quote from the  
leader — **PRESTEEL!**

104-D Barber Ave., Worcester 6, Mass.

Please ask your representative to call

Please send newest brochure

Name \_\_\_\_\_

Title \_\_\_\_\_ Company \_\_\_\_\_

Street \_\_\_\_\_

City \_\_\_\_\_ Zone \_\_\_\_\_ State \_\_\_\_\_

500 v full scale input range.  
Circle P58 inside back cover.



### POWER SUPPLY

magnetic amplifier type

OREGON ELECTRONICS, Portland 15, Oregon, has available a new magnetic amplifier type low voltage-high current power supply. Model 32V15A has closely regulated tolerance at 15 amperes output continuously variable from 5 to 32 v without switching. Regulation is rated at  $\pm 1$  percent from no load to full load, and  $\pm 1$  percent from 105 to 125 v input. Output ripple voltage is not over 1 percent rms at 32 v and full load and not over 2 percent at 5 v and full load. Circle P59 inside back cover.

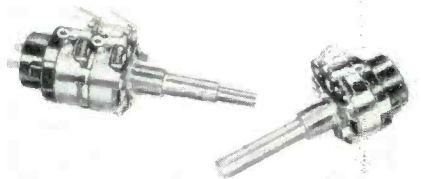

### PUSH-PUSH SWITCH

offers more convenience

CHICAGO TELEPHONE SUPPLY CORP., Elkhart, Ind. A new more convenient push-push switch which turns radio and tv sets on and off without requiring volume and contrast readjustment and also permits greater styling versatility in set manufacture is now offered. A push on the same double duty shaft turns on the switch; another push turns it off. After each push the shaft returns to its original position.

► Design Advantage — Type J

Never before... Duplexing and Break-In Without Relays

**NEW!**

**Northern Radio**

# DUPLEX TELEGRAPH SYSTEM

For Multi-Channel Tone Equipment

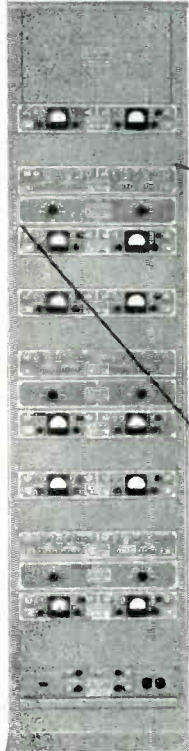

Dual Duplex Selector Panel,  
Type 200 Model 1

Dual Loop Switch Panel, Type 200A Model 1

**NEW!**

Simple 4 position switch selects from 12 possible duplex combinations.

**NEW!**

Duplex operation between stations connected via carrier telegraph channels.

**NEW!**

All-electronic, without relays or moving parts to wear.

**NEW!**

Polar or neutral for either half duplex or full duplex.

**NEW!**

Break-in now also possible for all half-duplex circuits.

**NEW!**

Provided with positive feature to prevent space signal lock-out.

**NEW!**

Includes individual line battery for each channel.

The Northern Radio Duplex Telegraph System consists of one each Dual Frequency Shift Tone Keyer, Type 153 Model 3; Dual Duplex Selector Panel, Type 200 Model 1; Dual Loop Switch Panel, Type 200A Model 1; and Dual Frequency Shift Tone Converter, Type 152 Model 3. The Frequency Shift Tone Keyer and Converter are our latest improved Model 3's, specifically designed for use with this system.

The Dual Duplex Selector Panel and Dual Loop Switch Panel make possible complete duplexing and break-in operation of a Northern Radio or similar multi-channel Frequency Shift tone telegraph system. Such a system meets the requirements of any standard telegraph line or terminal apparatus for either full duplex or half-duplex operation. Because this system is all-electronic, it meets all speed requirements and yet has the flexibility and isolation heretofore possible only with relays.

The Dual Loop Switch Panel rapidly selects half-duplex and/or full duplex mode of operation for any of the 4 standard loop options by front panel switching available from the 12 loop options in the Dual Duplex Selector Panel.

The Dual Duplex Selector Panel provides 12 loop options, patching facilities for monitoring purposes and channel routing, including the possibility of patching-in another teleprinter loop circuit (T-junction). Any of the 12 loop options are available and may be selected for the Dual Loop Switch Panel by simple strapping arrangement. It has an individual line battery for each channel for greatest circuit flexibility. Battery and line fuses are also provided for maximum protection.

The Dual Duplex Selector Panel is provided with positive non-lockout features. An accidental "spacing" of the line, even over prolonged periods of time, such as caused by patching errors, will not lock the system into a permanent space (no loop current) condition. The system will instantly be ready to operate as soon as the fault is removed. This is due to a novel arrangement of the internal batteries which at all times can provide power to the telegraph loops.



Peace-Setters in Quality Communication Equipment

**NORTHERN RADIO COMPANY, inc.**

147 WEST 22nd ST., NEW YORK 11, NEW YORK

In Canada: Northern Radio Mfg. Co., Ltd., 1950 Bank St., Billings Bridge, Ottawa, Ontario

WRITE FOR FREE CATALOG E-10

# TRANSFORMERS for your SPECIAL REQUIREMENTS

## TWO NEW



## SPECIAL UNITS

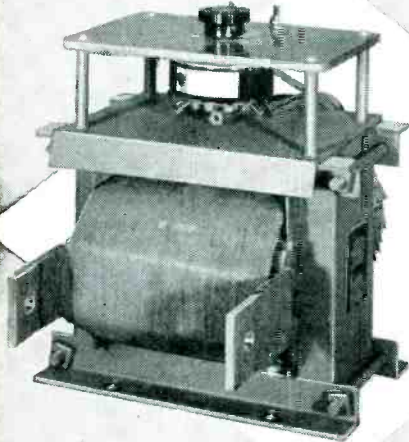

**Resistance Welding Transformer** with eight point tap-changing switch on primary winding. Used for a varying secondary current output. Unit shown is 3 KVA. Units are available from .5 to 50 KVA.

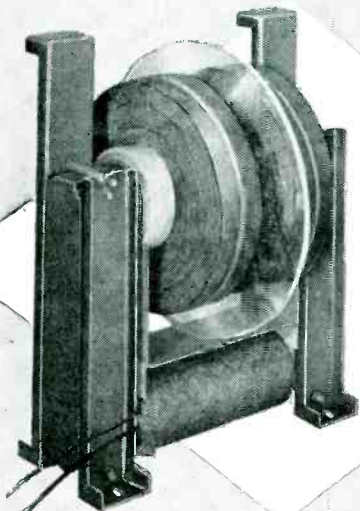

**High Voltage Plate Transformer** for use under oil with other equipment in same tank. Unit shown is 50 KV center tap grounded, 4 KVA and high impedance. Note plastic insulation shield between coils. This unit available from 100 VA to 100 KVA.

For any special transformer, you will get the highest quality, the fastest delivery, the most reasonable cost and the highest efficiency from Nothelfer Winding Laboratories. Their production is geared to the manufacture of special transformers, chokes and reactors.

Write for complete information, specifying your particular requirements.

 *Nothelfer*

**WINDING LABORATORIES, Inc.**

P. O. Box 455, Dept. 102, Trenton, N. J.

NEW PRODUCTS

(continued)

switch permits greater styling flexibility to set designers by using standard push-on type knobs instead of design restrictive captive type knobs and because the shaft returns to the same position after actuating the switch either on or off. The positive snap action enables the user to see, feel and hear the switching operation.

Type J is a 3-ampere 125-v, 1-ampere 250-v switch designed for use on a single section variable resistor with one shaft or on a concentric tandem with the inner shaft actuating both switch and rear section.

### D-C SOURCE for unattended installations

SORENSEN & Co., INC., Fairfield Ave., Stamford, Conn. Model MA65A is a regulated low voltage, high current d-c supply, utilizing magnetic amplifier circuitry for greater reliability. The new source is recommended for unattended installations, particularly in industry, because of its maintenance-free performance.

► **Specifications** — Input range is 105 to 125 v a-c, 1 phase, 60 cycle. Output voltage is 5.4 to 6.6 v d-c, adjustable. Load range is 0 to 5 amperes; ripple, 1 percent maximum. Regulation accuracy is  $\pm 0.2$  percent against line or load (1/10 to full). Recovery time is 0.15 sec.

Complete specifications and performance data are available from the company. Circle P60 inside back cover.

### CRYSTAL OVEN features a noval base

JAMES KNIGHTS Co., Sandwich, Ill. A new miniature crystal oven designed for HC-6U holder, less than an ounce in weight, has a temperature stability of  $\pm 0.25$  C at constant ambient temperature range of  $-55$  C to  $+75$  C.

The JKO-10 crystal oven features a noval base, easily detachable cover and new heater binding tape and low inductance winding.

► **Specifications**—It is manufac-



## IMPORTANT DEVELOPMENTS AT JPL

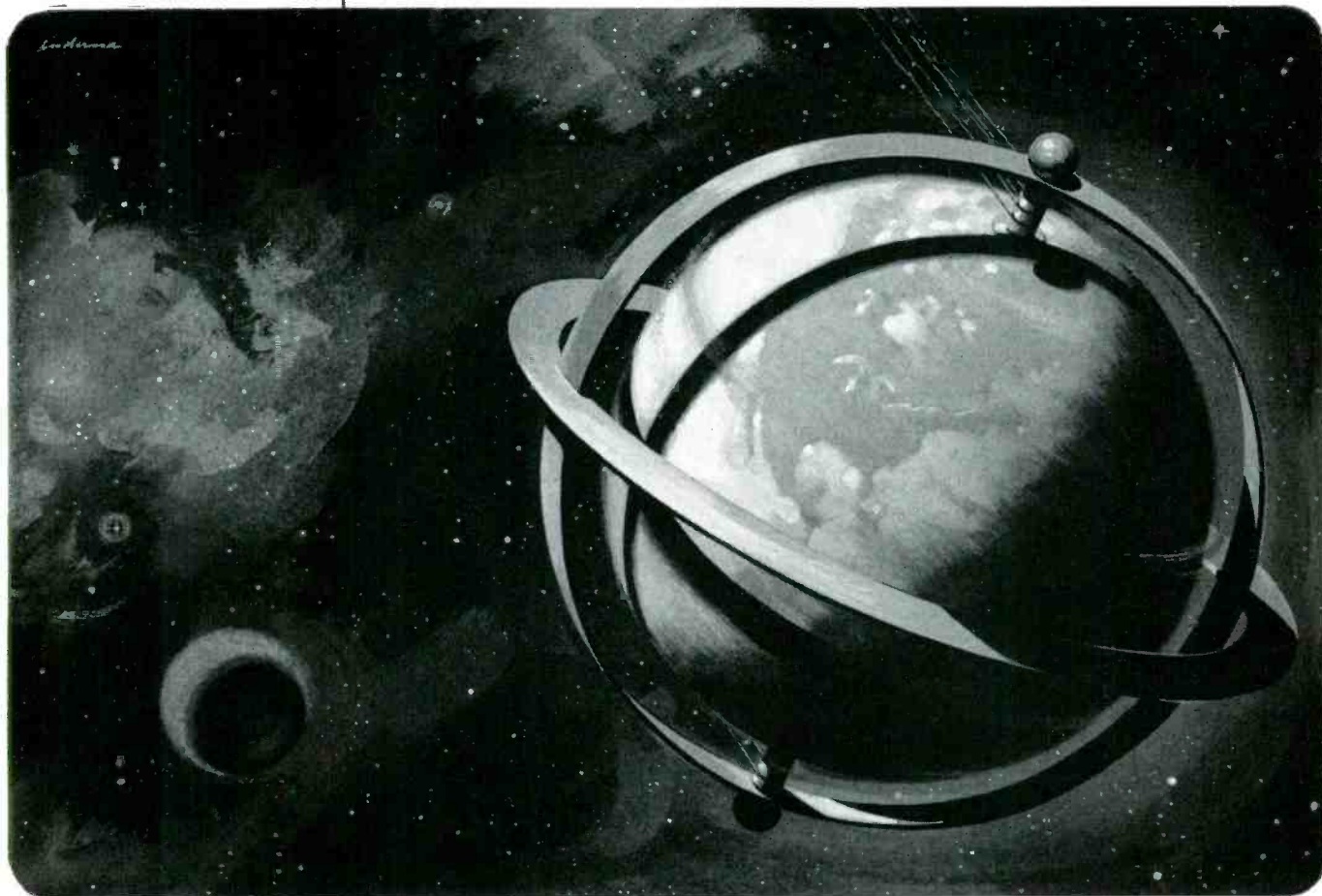

*The Jet Propulsion Laboratory is a stable research and development center located to the north of Pasadena in the foothills of the San Gabriel mountains. Covering an area of 80 acres and employing 1550 people, it is close to attractive residential areas.*

*The Laboratory is staffed by the California Institute of Technology and develops its many projects in basic research under contract with the U. S. Gov't.*

*Qualified personnel employment inquiries now invited.*

### Pioneers in Guidance Systems

For many years the Jet Propulsion Laboratory has pioneered in the design and development of highly accurate missile guidance systems, utilizing the most advanced types of gyroscopes, accelerometers and other precision electro-mechanical devices. These supply the reference information necessary to achieve the hitherto unattainable target accuracies sought today.

The eminent success of the early "Corporal" missile flights shortly after World War II firmly established the Laboratory as a leader in the field of missile guidance. These flights also initiated experiments involving both inertial and radio-command systems employing new concepts of radar communication. Because of this research and experimentation JPL has been able to add materially to the fund of knowledge

available to designers of complex missile systems.

This development activity is supported by basic research in all phases of electronics, including microwaves and antennas, new circuit elements, communications and reliability in addition to other branches of science necessary to maintain a fully integrated missile research organization.

The Jet Propulsion Laboratory, therefore, provides many challenging opportunities to creative engineers wishing to actively apply their abilities to the vital technical problems that require immediate and future solution.

We want to hear from men of proven ability. If you are interested please send us your qualifications now.

JOB OPPORTUNITIES  
IN THESE FIELDS NOW



INSTRUMENTATION • APPLIED PHYSICS • DATA HANDLING • COMPUTERS  
TELEMETERING • RADIO AND INERTIAL GUIDANCE • GUIDANCE ANALYSIS  
SYSTEMS ANALYSIS • MICROWAVES • ELECTRO-MECHANICAL • PACKAGING  
MECHANICAL ENGINEERING

### JET PROPULSION LABORATORY

A DIVISION OF CALIFORNIA INSTITUTE OF TECHNOLOGY  
PASADENA • CALIFORNIA

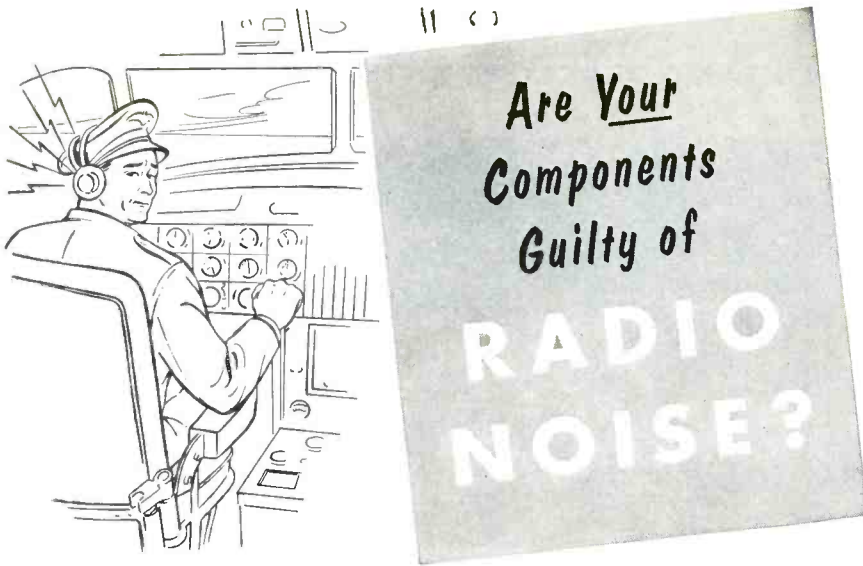

**POTTER** can tell you "why"

**POTTER** can tell you "how"

and **POTTER** can make the **FILTER** that will confirm that "how"

Once it's stated completely and correctly, a problem is half solved.

Potter can put the facts and figures of your problem on paper . . . can chart its limits in laboratory tests . . . can engineer the solution. And Potter can embody that solution in subsequent design and production.

Call Potter to engineer, design and produce the filter to solve your radio interference problem.

Write for Bulletin 41A.

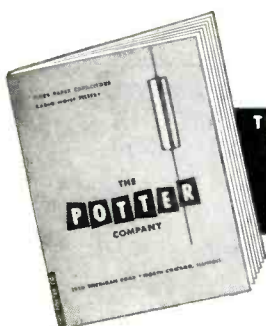
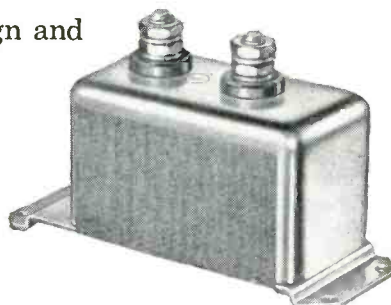

THE **potter** COMPANY

SPECIALISTS IN  
FIXED PAPER  
CAPACITORS  
SINCE 1925

1950 SHERIDAN ROAD  
NORTH CHICAGO, ILL.

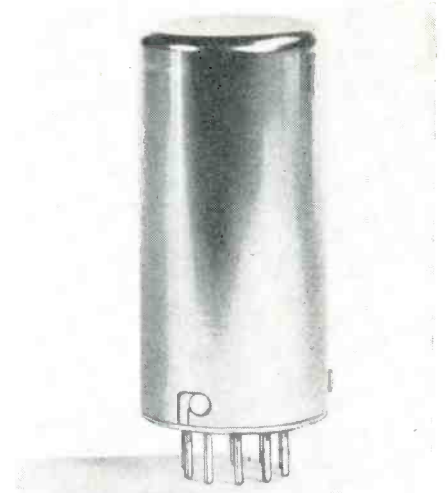

tured in a choice of heater voltages from 6.3 v to 48 v, a-c or d-c for greater flexibility, and has a rapid warm-up time of 7 minutes at  $-55^{\circ}\text{C}$ . It has a seated height of 1.75 in. and a diameter of 0.875 in. It is also available for the HC-13U holder with seated height of 2.25 in. Circle P61 inside back cover.



### POWER SUPPLY

two-pound, 50-watt type

UNIVERSAL ATOMICS CORP., 19 E. 48th St., New York 17, N. Y. Complete electronic d-c to d-c transistorized power supplies that deliver 50 w from 24 v input, weigh only 2 lb, and fit in the palm of the hand, are now available.

► **Uses**—Light weight and compact size make these units especially suitable for guided missiles, rockets, aircraft, marine, and police mobile communications and emergency power systems.

Other standard power supplies in the series cover a voltage range from 20 to 20,000 (one miniature

# If you're not in the book *you're* *a man without*



- . . . . . a country
- . . . . . a state
- . . . . . a county
- . . . . . a town
- . . . . . a party
- . . . . . a street
- . . . . . a school
- . . . . . a *vote*

Look at all the things you can lose, if you're not a registered voter.

If you're not in the book, you lock yourself out of the elections. The polls are closed to you. You can't vote on streets, or schools, councilman or mayor (not to mention congressman, senator or president). You don't even have the right to *complain* about your government and the way things are run!

But more than that, you cut yourself apart from your neighbor next door, your friends at

the shop, your fellow members in union or club.

You lose the right to look that boy of yours in the eye when he wants to know if you're doing your part.

And you lose the self-respect that comes from knowing you can walk into the polls on Election Day—the one place in the world where all free men are really equal. Isn't it too much to risk for the little time that registering takes?

Get your name in the book  
—and do it now!

## *Is your name in the book?*



# ADCOLA

ADCOLA MULTIVER  
(Regd. Trade Mark)

## ELECTRIC SOLDERING INSTRUMENTS & EQUIPMENT

### ILLUSTRATED

3/16" Detachable Bit Type (List No. 64).  
For Factory Bench Line Assembly.

### TYPES AVAILABLE

- 1/8" Bit (Subminiature Work Electronics).
- 3/16" Bit (General Assembly Telecommunications Etc.).
- 1/4" Bit (Heavy Tagging).

### MANUFACTURED IN ALL VOLTAGES

American, Canadian, British  
Foreign Patents  
&  
Registered Designs.

C. S. A. Approved



Write for Catalogues & Information:

**CANADA** L. J. Lamb, Box 103, Weston, Ontario

**ENGLAND** Sole Proprietors:  
ADCOLA Products Ltd.  
Gauden Road  
Clapham High Street  
London, S. W. 4

**TELEPHONES**  
MAcaulay 4272  
MAcaulay 3101

NEW PRODUCTS

(continued)

2-in. unit weighs only 2 oz, delivers 2,000 v from 1½ v input). Circle P62 inside back cover.

### TV PICTURE TUBES for portable units

SYLVANIA ELECTRIC PRODUCTS INC., 1740 Broadway, New York 19, N. Y., has announced two new lightweight 10-in. tv picture tubes for portables. Types ST-1925 and ST-1926 feature decreased weight, larger screen area and better contrast.

► **Specifications**—Both tubes have a standard neck diameter, 90-deg deflection and electrostatic focus. Anode voltage is 13.2 kv, absolute maximum, and nominal overall length is 11<sup>7</sup>/<sub>8</sub> in. The tubes weigh 3 lb, 10 oz, and have an approximate screen area of 56½ sq in.

Better contrast is provided by gray filter glass which substantially increases picture contrast. The tubes have spherical faceplates. The ST-1926 is aluminized, while the ST-1925 is not. Circle P63 inside back cover.

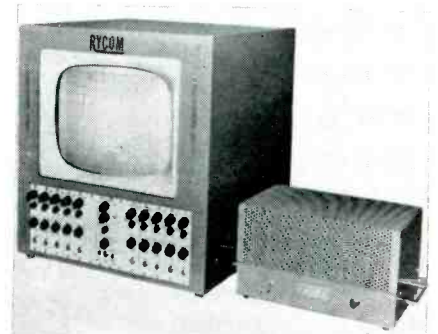

### MULTITRACE SCOPE uses 17-in. c-r tube

RYCOM INSTRUMENTS, 9351 E. 59th St., Raytown, Mo., has released the model 2400 series multitrace large screen oscilloscope for use in medical and industrial waveform study. It utilizes a 17-in. kinescope to display simultaneously the 12 presentations of complex waveforms.

► **Switching**—Incorporated is a new method of electronic switching which utilizes a switching rate of 20,000 cps, allowing good presentation of input waveforms with components of 2 kc or more. With

this type of switching the number of traces is limited only by the physical size of the kinescope.

The oscilloscope features individual plug-in units for channels and sweep. Each channel has its own individual controls for input, position, intensity and gain. Input circuits are balanced push-pull d-c coupled, having an input sensitivity of 10 mv for 1 in. deflection.

Also incorporated in the oscilloscope are two special circuits for medical waveform study. This includes a circuit for vector cardiography and a 60-cycle interruptor for l-f sweep range. Circle P64 inside back cover.

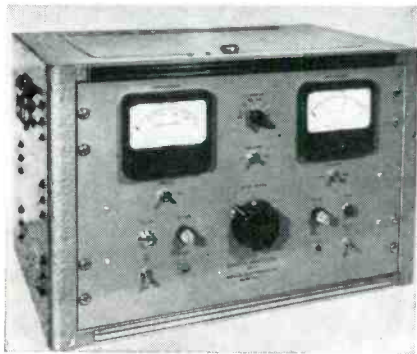

### HIPOT TESTER with 10 $\mu$ a circuit breaker

PESCHEL ELECTRONICS INC., 17 Garden St., New Rochelle, N. Y., has announced a new improved line of sensitive Hi Pot testers which automatically deenergize high voltage when leakage current in samples reaches 10  $\mu$ a. Models are available from 2 kv up to 120 kv and special units can be custom built. The smaller units are adjustable up to 1,000  $\mu$ a, and larger units up to 5,000  $\mu$ a.

► **Other Features**—Series H tester avoids the brute force method of burning up fine equipment and components when testing for leakage. Hi Pot testing allows convenient and accurate dielectric testing of equipment, components and materials. With the new tester, the high sensitivity shows up leakage currents in insulation which appear to be perfect on less sensitive instruments.

Standard features include both a-c and d-c outputs and con-



## FISHBOWLS THAT FLY!

You'll recognize these flying fishbowls as bombsight windows. Specifications require that these hyperhemisphere lenses be ground to precision tolerances of fractions of a wavelength of light. Bausch & Lomb optical competence made volume production possible . . . by new adaptation of diamond cutting wheels, ring-shaped laps, and induction-heat blocking. Find out how B&L advance technology can help expedite *your* contract plans.

**WRITE FOR COMPLIMENTARY  
COPY OF LIMITED EDITION,  
"OPTICAL COMPETENCE"**

(on official letterhead, please,  
indicating title). Bausch & Lomb  
Optical Co., 81210 St. Paul Street,  
Rochester 2, N. Y.

America's only complete optical source . . . from glass to finished product.

**BAUSCH & LOMB**

SINCE 1853



Complementing

the most sensitive design...

**JEWEL**

**BEARINGS**

by

*Bird*



No matter how exacting the conditions,

*Bird* **JEWEL BEARINGS**  
**ASSEMBLE MORE READILY and**  
**FUNCTION MORE EFFICIENTLY.**

A variety of settings and mounts, plus a wide range of sizes (stock sizes, or to specification), enables these high-precision elements to be ideally incorporated.

In addition, various settings and cushioning methods — silicon rubber, spring, or friction settings — provide maximum protection for bearings subject to severe shock conditions, yet permit controlled jewel movement, thus ending lost time for tear-down and readjustment.

Of particular advantage are the complete jewel assemblies, set in screws or bushings, which Bird provides in standard sizes or to your specifications. These assemblies greatly reduce overall cost by eliminating rejects, stopping waste, and cutting assembly time. Prove these advantages in your own plant. Forward a print to us with specifications — we'll provide you with testing samples.

For information on Bird Jewels write for Bulletin 14

Over 40 years of serving Industry with Quality Jewel Bearings

*Stringent  
quality control methods,  
exact tolerances and  
design features insure*

- ✓ **LASTING PRECISION PERFORMANCE**
- ✓ **LONGER INSTRUMENT LIFE**
- ✓ **VERSATILE ADAPTABILITY**

*Richard H. Bird* & Co., Inc.  
SAPPHIRE AND GLASS JEWELS, PRECISION GLASS GRINDING,  
JEWEL MOUNTING AND ASSEMBLY, SAPPHIRE STYLII  
1 Spruce Street, Waltham 54, Mass.

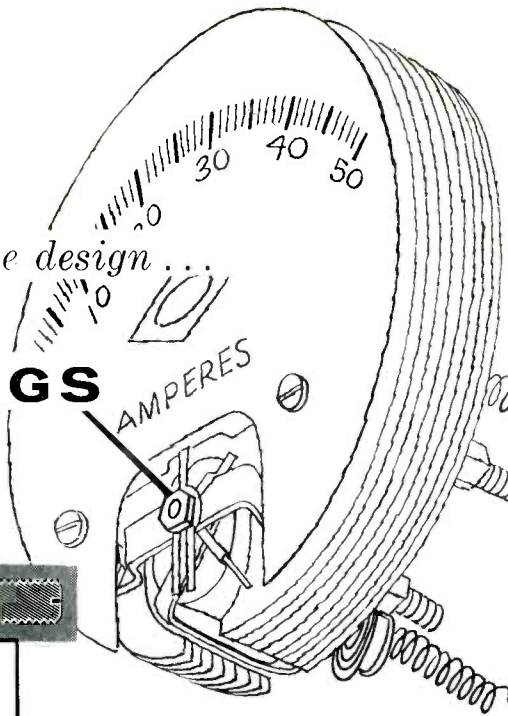

tinuously adjustable output voltage. Accurate hand-calibrated dual-scale metering, directly across the h-v output, can be recalibrated by a simple screwdriver adjustment. A self-holding primary contactor prevents the accidental reapplication of high voltage after a line failure. The unit is complete with full safety controls and dead-front panel controls; safety resistor in d-c output lead. Circle P65 inside back cover.



### COUNTING EQUIPMENT for industrial applications

ELECTRO-PULSE, INC., 11861 Teale St., Culver City, Calif. Model 7340A frequency indicator and counter provides an economical solution to a wide range of industrial problems in the field of counting and recurrence rate measurement of mechanical and electrical events. The instrument is ideal for such applications as rpm measurement, oscillator calibration, direct counting and flow measurement.

Counting and indication with automatic decimal point location is easily read from glow transfer tubes directly in events per sec ranging from 1 to 9,999 events. A precision synchronous motor establishes the gate time (from 1 to 10 sec) during which input events are counted. For gate times longer than 10 sec or for cases where a straight counter is desired a manual gate switch is provided. For applications requiring a permanent record of readings, the instrument can be delivered as the model 7341A (illustrated), with outputs for driving a serial type print-out. Circle P66 inside back cover.

## New Literature

**Precision Resistor.** Weston Electrical Instrument Corp., 614 Frelinghuysen Ave., Newark 5, N. J. Volume 11, No. 2 of *Engineering Notes* features the Vamistor, a thermally fused metal-to-ceramic precision resistor. Description, construction and specifications are given. Included are resistance-range and temperature coefficient curves. Tabular material on actual test results is also shown. **Circle L1 inside back cover.**

**Precision Potentiometers.** Helipot Corp., Newport Beach, Calif. Data sheet 54-39 illustrates and describes the series 5300 high precision, single-turn continuous rotation potentiometers. A cutaway illustration shows precision construction. Included are a dimensional diagram, specifications of standard linear models, characteristics of typical linear coils, and modifications available in the 5300 series. **Circle L2 inside back cover.**

**Magnetic Storage Systems.** Monroe Calculating Machine Co., Electronics Division, Morris Plains, N. J., has available an 8-page booklet on its ultrareliable Monrobot magnetic drum systems and components. The magnetic drums, read/record heads and magnetic selection circuits are illustrated and described in a new 8-page brochure.

Highlights are 2,000,000 bit drum and stacked wafer-thin read/record heads providing 16 tracks per in. with interlacing of only two stacks. **Circle L3 inside back cover.**

**Choosing Fluxes For Soldering.** Anchor Metal Co., Inc., 244 Boerum St., Brooklyn 6, N. Y. A new 4-page folder, "The Right Flux for the Right Job," simplifies the proper selection of corrosive and noncorrosive fluxes for all metal joining from Alnico to zinc. Detailed information is given in two main sections listing rosin-type fluxes for electrical and electronic joining that require noncorrosive flux residues; and

acid-type fluxes for general all-purpose soldering requiring strong flux action to remove surface oxides.

Also included as aids to engineer and production man are a flux selection chart that quickly pinpoints the right flux for the right metal, plus detailed tables of ASTM standard solders and Federal specifications for soft solders. **Circle L4 inside back cover.**

**Laminated Tubing.** Lamtex Industries, Inc., 51 State St., Westbury, L. I., N. Y. Technical data sheet 221 gives an illustrated description of Poro-Tube, a new laminated tubing with the exclusive feature of porous wall construction. It includes a magnified photo of the tubing, clearly illustrating the uniform, controlled porosity. Sizes, shapes, weight and temperature characteristics are given. Also included is a helpful list of suggested applications for this new material. **Circle L5 inside back cover.**

**Analog-to-Digital Converters.** Norden-Ketay Corp., Wiley St., Milford, Conn. Bulletin 372 contains comprehensive specifications and typical applications for the company's analog-to-digital converters. The units described are estimated to operate for 4 million revolutions, or better than 500 million counts at 200 rpm before cleaning is required. **Circle L6 inside back cover.**

**Standard Reflections, Coax Slotted Lines.** The Narda Corp., 160 Hericks Road, Mineola, L. I., N. Y. A new line of standard reflections specifically designed for calibrating slotted line impedance meters and standardizing reflectometers in the frequency range of 2,600 to 18,000 mc, are described in a recently published data sheet.

Another data sheet describes model 230 type N and model 230B  $\frac{1}{8}$  in. coaxial slotted lines of the parallel plane type for the frequency range of 300 to 4,000 mc. Specification tables and prices

TRANSISTORIZED

PULSE TEST EQUIPMENT

by *Navcor*



NAVCOR'S new series of 100A building blocks are basically designed as portable bench top test equipment. Each NAVCOR logic block unit is completely transistorized and stabilized over wide operating ranges . . . and the built-in power supply utilizes only two voltages to power up to 15 plug-in units. Individual units can be readily interconnected by back panel 'patch board' plugs to build-up a complete data handling system.

As test equipment, or as integral components of industrial control or data handling systems—the NAVCOR 100A series of pulse generating and programming test equipment can be used in all projects involving magnetic logic and switching transistor circuits up to 200 KC. All standard logic functions are available including pulse generators, standardizers, delays, counters, and shift registers.

Specification sheets available!

NAVIGATION COMPUTER CORP.

1621 SNYDER AVE.

PHILADELPHIA 45, PA.

PHONE: HOward 5-7700



# 's Low-Cost High-Power RWT RESISTRIMS

## Now Available In Production Quantities

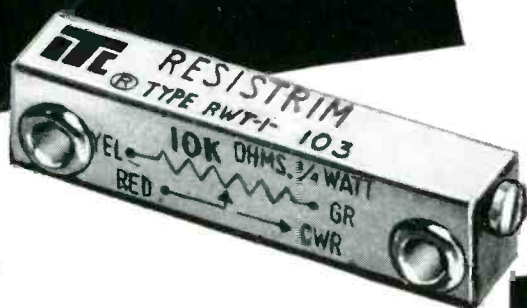
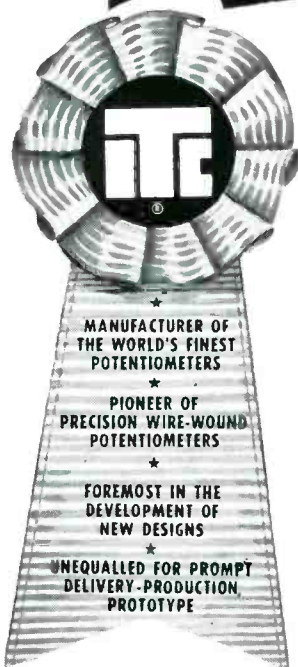

The RWT is now in full production. This latest addition to TIC's precision trimmer potentiometer line — most complete in the industry — provides a high-power, low-cost, stable, and compact unit for fixed-gain adjustments . . . padding . . . critical bias . . . and balancing adjustments.

The wire-wound RWT incorporates the advanced mechanical design of the popular TIC RFT Metfilm Trimmer. Permits precise trimming with a unit less than 1/10 of cubic inch in volume. Advanced mechanical design provides: Complete environmental protection with one-piece anodized aluminum base and sealed stainless-steel cover . . . less

than 4/10 ounce in weight . . . and precise stable adjustment with a 25-turn, stainless-steel lead screw.

RWT provides standard temperature range from  $-55^{\circ}\text{C}$  to  $+95^{\circ}\text{C}$  . . . wide resistance range from 50 to 20K ohms . . . and a power rating of 2 watts at  $25^{\circ}\text{C}$  derated to 1/4 watt at  $95^{\circ}\text{C}$ . Special units are also available for operation up to  $+145^{\circ}\text{C}$  and power ratings up to 1/4 watt at  $125^{\circ}\text{C}$ .

For complete specifications on the RWT request Bulletin TP-200.

## TECHNOLOGY INSTRUMENT CORP.

569 Main Street, Acton, Mass., COlonial 3-7711  
West Coast Mail Address, Box 3941, No. Hollywood, Calif., POplar 5-8620

are included in both data sheets.  
Circle L7 inside back cover.

**Electronic Cable.** Pacific Automation Products, Inc., 10000 Air Way, Glendale 1, Calif., has released bulletin 656 entitled "Electronic Cable as a Systems Component." The 4-page brochure explains in detail how cable is designed, fabricated, installed and tested to meet system requirements.

An interesting feature of the bulletin is the reproduction of a form for ordering electronic cable. This form simplifies the detailing of a cable and provides the essential information for ordering without the need of drawings. Circle L8 inside back cover.

**Digital Readout Systems.** Coleman Engineering Co., Inc., 6040 W. Jefferson Blvd., Los Angeles 16, Calif., has prepared a 4-page bulletin CR-181 giving useful information concerning their 3, 4, 5 and 6-decade decimal digitizers. Included are many typical uses and applications of these digital readout systems and 10 photographs of the equipment in use. Circle L9 inside back cover.

**Subminiature Relay.** General Electric Co., Schenectady 5, N. Y. A 2-page, 2-color bulletin on the new 2pdt hermetically-sealed subminiature relay is now available. The publication, designated GEA-6412, lists the relay's operating advantages in a wide variety of electronic applications on aircraft, shipboard and ground equipment; and discusses the operation of the relay.

The bulletin also provides a table of technical data on the operating characteristics of the relay along with a table of coil data which lists coil voltage, coil resistance, pickup voltage, pickup current and dropout voltage. Circle L10 inside back cover.

**Deflection Yokes.** Syntronic Instruments, Inc., 170 Industrial Road, Addison, Ill. A revised catalog page pictures and completely describes magnetic deflection yokes for 1½ in. neck diameter military and oscilloscope applications. Complete data include



design features, dimensional drawing, and revised tables listing electrical and mechanical characteristics, push-pull deflection coil data and single-ended deflection coil data. **Circle L11 inside back cover.**

**Hook-Up Wires.** Revere Corp. of America, Wallingford, Conn. New Permacode extruded Teflon hook-up wires are described in bulletin No. 1901. Permacode wires, which now provide positive and permanent identification with the color extruded throughout the insulation, are available in 15 solid colors or in striped combinations of 2, 3 or 4 of the solid colors. The bulletin includes constructions of various gage sizes built to meet requirements of military specification MIL-W-16878, types E and EE, and gives ordering information. **Circle L12 inside back cover.**

**Flowmeter.** Industrial Development Laboratories, Inc., 17 Pollock Ave., Jersey City 5, N. J. A 4-page catalog describes the function, construction and operation of the Laub Electro-Caloric flowmeter which consists of a flow cell and an electronic responder. A cut-away view clearly illustrates the construction of the smooth-bore flow cell while a simple diagram effectively shows the principles of operation. Standard sizes and materials are listed and complete mechanical and electrical specifications are furnished. **Circle L13 inside back cover.**

**Recording Oscillograph.** Consolidated Electrodynamics Corp., 300 N. Sierra Madre Villa, Pasadena, Calif. Bulletin 1533-B fully illustrates and describes the type 5-117 recording oscillograph, which offers precision recording of six data traces at frequencies from 0 to 300 cps. Included is information on associated instruments as well as a price list. **Circle L14 inside back cover.**

**Printed Circuit Connectors.** DeJur-Amsco Corp., 45-01 Northern Blvd., Long Island City 1, N. Y. A 12-page technical brochure covers an expanded line of printed circuit receptacles for  $\frac{1}{8}$  in.,  $\frac{3}{8}$  in. and

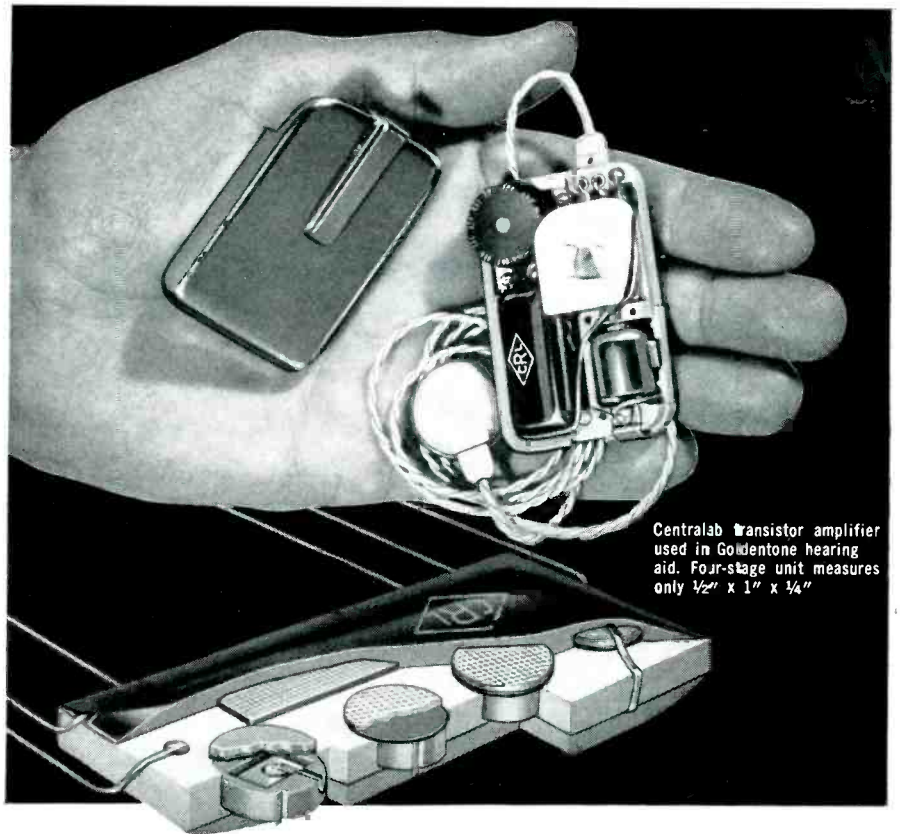

Centralab transistor amplifier used in Goldentone hearing aid. Four-stage unit measures only  $\frac{1}{2}$ " x 1" x  $\frac{1}{4}$ "

*Today's smallest complete amplifier demonstrates*  
**a new technique  
 for packaging  
 electronic components**

**Another first by Centralab,  
 pioneer in miniaturization**

*One-, three-, and four-stage transistor amplifiers are ideal for:*

- Hearing aids*
- Small radios*
- Recorders*
- Microphones*
- Military equipment*
- Television*
- Electro-medical units*
- Other space-saving applications*

- ◆ Special transistors and diodes developed by Centralab are hermetically sealed into a ceramic base plate in this unique Packaged Electronic Circuit which also includes capacitance, resistance, inductance, and wiring.
- ◆ Not laboratory specimens — standard one-, three-, and four-stage transistor amplifiers that are being used successfully in industry on many applications. Special designs can be adapted to your requirements.
- ◆ Complete amplifier units reduce your production costs — there are fewer individual parts to buy, inventory, assemble, and test. For example, a four-stage transistor amplifier replaces 21 parts — four transistors, five capacitors, 12 resistors, plus wiring. Soldering connections are reduced from 46 to 7.

*Write for Technical Bulletin EP-75*

**Centralab**

**A DIVISION OF GLOBE-UNION INC.**

914J East Keefe Avenue • Milwaukee 1, Wisconsin  
 In Canada: 804 Mt. Pleasant Road, Toronto, Ontario

Y-2656



VARIABLE RESISTORS

ENGINEERED CERAMICS

SWITCHES

PACKAGED ELECTRONIC CIRCUITS

CERAMIC CAPACITORS



# LABORATORY AND TESTING INSTRUMENTS

NEW LITERATURE

(continued)

$\frac{1}{2}$  in. boards. Illustrations, outline drawings and application suggestions are included. Circle L15 inside back cover.

**Multiplier Phototubes.** Allen B. DuMont Laboratories, Inc., 2 Main Ave., Passaic, N. J. The latest specifications and additional circuit data on the company's entire line of multiplier phototubes are now available in a revised 64-page catalog. It discusses operational theory, applications and specifications for standard and special multiplier phototubes. Illustrations, graphs and circuit diagrams are included. Requests for the catalog should be on company letterheads.

**Synchro Null Connections.** Theta Instrument Corp., 204 Market St., E. Paterson, N. J., is offering free to interested engineers a chart of synchro null connectors based upon new industry standards. At a glance, the chart provides the proper synchro lead combinations which produce nulls at the various rotor angles. Circle L16 inside back cover.

**Special Purpose Receiver.** Nems-Clarke, Inc., 919 Jesup-Blair Drive, Silver Spring, Md. A single-sheet bulletin deals with the type 1502 special purpose receiver which is useful in telemetering, guided missile, radiosonde reception and as a high quality general purpose laboratory receiver where high sensitivity and low noise are desired. Circuit description and specifications are included. Price of the unit described is \$1,750. Circle L17 inside back cover.

**Microminiature Relay.** General Electric Co., Schenectady 5, N. Y., has available an 8-page bulletin, GEA-6346A, on its hermetically-sealed microminiature relay. It provides a detailed description of the lightweight relay for airborne, shipboard and portable unit applications. Operating features are listed and discussed individually, and a complete table of specifications is included. In addition, the bulletin contains photographs of the company's various types of microminiature relays, a coil data table for each model, and tech-

## THREE TERMINAL CAPACITANCE BRIDGE



**CORRECTION NOTICE**  
In the June 1956 Buyers' Guide issue accuracy read 25% instead of 0.25%

- Cap. Range: .001 mmf to 11,000 mmf
- Approx. accuracy:  $\pm (0.25\% + .001 \text{ mmf})$
- Measures direct and grounded capacitance
- Measures conductance directly
- Self contained oscillator and detector
- Ideal for temperature coef. measurements
- Particularly suited for vacuum tube, transformer, and cable capacitance measurements

Model 74C

PRICE \$850.00

## SENSITIVE RF VOLTMETER

- Range: .001 volt to 3 volts
- Freq. Range: .2-400 megacycles
- Accuracy:  $\pm 5\%$  full scale
- RMS response below .1 volt
- High impedance probe
- 52 ohm probe; max. vswr 1.06
- Power sensitivity: .02 microwatt

MODEL 91A

PRICE \$375.00



## RF DISTORTION METER AND VOLTMETER



- Frequency Range: 1 to 100 mc
- Sensitivity: 70DB below 3 volts
- Accuracy:  $\pm 2\text{DB}$
- Input Impedance: approx. 50 ohms
- Fast, easy operation
- Same Voltmeter features as Model 91A above

MODEL 85B

PRICE \$675.00

## UHF GRID DIP METER

- Widest freq. range: 300 to 1000 mc
- Small, lightweight probe
- High sensitivity for both capacitive and inductance coupling
- Frequency accuracy,  $\pm 2\%$
- Very stable oscillator
- High Q absorption frequency meter

MODEL 101B

PRICE \$275.00

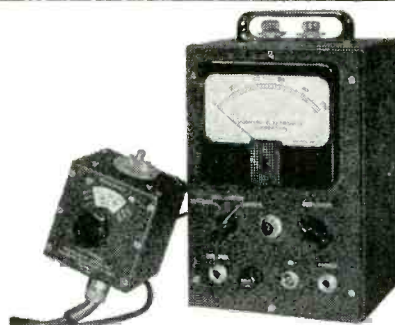

## BOONTON ELECTRONICS CORP.

Morris Plains, N. J. • Phone: JEFFERSON 8-5110

nical data on the types of cans and mounting available. **Circle L18 inside back cover.**

**Selenium Power Rectifiers.** International Rectifier Corp., 1521 E. Grand Ave., El Segundo, Calif. Catalog sheet 10-0306 covers selenium industrial power rectifiers. Typical uses and specifications are given. **Circle L19 inside back cover.**

**Liquid Rosin Flux.** Alpha Metals, Inc., 56 Water St., Jersey City, N. J. Bulletin No. 2 is a new 2-page technical bulletin giving a complete description, uses, properties and methods of application of the company's No. 346 activated liquid rosin flux. A helpful graph showing the concentration-density relationship of No. 346 flux and Alpha's No. 446 flux thinner is included.

The information given will be of particular interest to those involved in electronic soldering and printed circuit soldering where extremely fast wetting action combined with a moderate drying rate is required. **Circle L20 inside back cover.**

**Small Parts Welding Equipment.** Raytheon Mfg. Co., 100 River St., Waltham 54, Mass. Bulletin 2-100 is a new 2-color, 16-page, illustrated welding equipment catalog, valuable to manufacturers who have problems in joining small metal parts. The catalog features the company's line of welding heads, power supplies, all-electronic control units and welding accessories.

Important facts covered in the new catalog range from information on proper selection of a-c or d-c (stored energy) welding systems, uses of resistance welding equipment, welding hints, and Raytheon welding equipment applications. **Circle L21 inside back cover.**

**Fractional H-P Motors.** Rae Motor Corp., 2009 Kewaunee St., Racine, Wisc. New developments in fractional h-p motors and gear reduction units are shown in the new 16-page catalog. The company manufactures a-c/d-c universal,

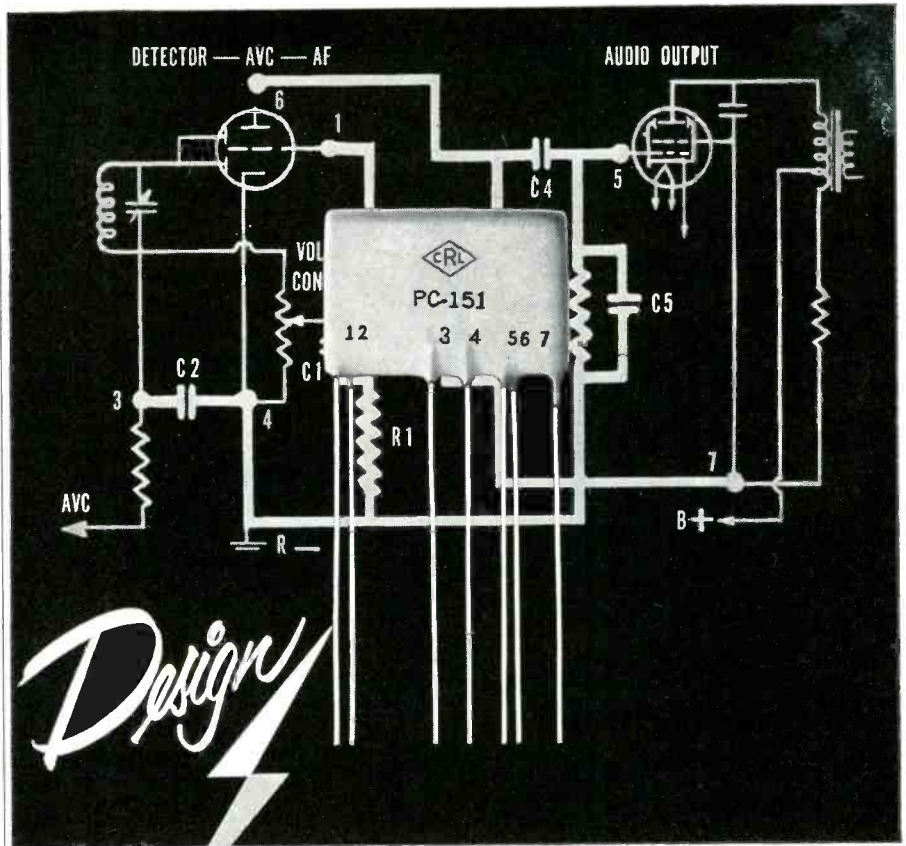

## Packaged Electronic Circuits

*into your future!*

A Centralab Packaged Electronic Circuit is a complete circuit built to your requirements — including wiring, capacitance, resistance, and often inductance, completely enclosed with a layer of baked Durez Phenolic which is vacuum sealed with Cerese (AA) Wax. These P.E.C.'s\* will pass all Mil-R-11, Mil-R-11A, and Mil-C-11015A requirements within their range.

**One Packaged Electronic Circuit Can Do the Job of 6 or More Single Components**

- ◊ Save Space
- ◊ Save Assembly Costs
- ◊ Save Weight
- ◊ Save Inventory Cost

60,000,000 P. E. C.'s have been used by leading manufacturers.

There are 160 standard P.E.C.'s available at your local Centralab Parts Distributor, in kit form or individual units for immediate shipment. For special requirements, send us your specifications for recommendations and quotations.



Write for Centralab Packaged Electronic Circuit Guide No. 3.

# Centralab

Y-1656

®Trademark

**A DIVISION OF GLOBE-UNION INC.**

914J East Keefe Avenue • Milwaukee 1, Wisconsin  
in Canada: 804 Mt. Pleasant Road, Toronto, Ontario



# now—weld even “difficult” metals instantly with weldmatic stored-energy welders



Weld stainless steel, copper, silver, tungsten, molybdenum and other “problem” metals easily and in millisecond time. Weldmatic resistance welders speed precision metal-joining operations in electronic, instrument, aviation and general industrial work, displacing slower, costlier methods such as soldering, silver brazing, riveting and staking. Weldmatic-welded joints offer better mechanical performance, higher tensile strength, better fatigue resistance. Dissimilar metals and parts of widely varying thicknesses are joined with ease and require no preconditioning. Welds are strong and uniform—no discoloration or metallurgical change, no excessive deformation. Weldmatic welders are easy to set up and simple to operate.

*there's a weldmatic for every precision assembly task*

- A. weldmatic model 1012—Portable, Tweezer type handpiece. Extra-long leads.
- B. weldmatic model 1015—Bench mounted. Accommodates special-purpose electrodes and handpieces.
- C. weldmatic model 1016—Portable. Has two interchangeable handpieces, extra-long leads.
- D. weldmatic model 1020—Console type for heavier precision welding.

### APPROXIMATE WORK CAPACITY

MODEL NUMBER	LOW CONDUCTIVITY MATERIALS		HIGH CONDUCTIVITY MATERIALS	
	Sheet Thickness	Wire Diameter	Sheet Thickness	Wire Diameter
1012	.0005 to .010	.00015 to .030	.0003 to .005	.0001 to .015
1015	.0005 to .020	.0002 to .060	.0003 to .010	.0002 to .030
1016	.0005 to .015	.0001 to .045	.0003 to .008	.0001 to .020
1020	.0005 to .035	.001 to .095	.0003 to .020	.001 to .060

*write for descriptive literature and details of sample welding service*

## WELDMATIC

a division of unitek corporation

257 NORTH HALSTEAD AVENUE • PASADENA, CALIFORNIA

VISIT OUR BOOTH AT THE  
AIRCRAFT ELECTRICAL  
SOCIETY SHOW  
LOS ANGELES, CALIFORNIA

d-c shunt and d-c permanent magnet fractional h-p motors which can be wound from approximately 1/300 to 1/4 h-p. All are available with governors if desired.

Also shown is the complete line of speed reduction units made by Rae for their motors. They are made in open or closed type and single or double reduction. Circle L22 inside back cover.

**Electronic Micrometers.** J. W. Dice Co., 16 Highwood Ave., Englewood, N. J. Bulletin 4003 illustrates and describes four reference standard, hand operated, direct reading electronic micrometers for making direct measurements to 20 millionths of an inch. The units discussed are applicable to hard or soft materials, conducting or nonconducting. They are unaffected by temperature, vibration, leveling or aging of tubes. Circle L23 inside back cover.

**Mica Insulation.** Mica Insulator Co., P. O. Box 1076, Schenectady 1, N. Y. A 16-page illustrated booklet describes the background and development of continuous sheet mica, and tells how it is made today. It includes detailed information about the various types of Isomica—molding, segment, heater and flexible plates; tapes, flexible combinations, tubes and capacitor grade as well as Samica, the untreated continuous sheet mica.

A full page chart in the booklet shows comparative effect of high temperature on the dielectric strength of epoxy Isomica, silicone Isomica, silicone rubber glass cloth and silicone varnished glass cloth. Circle L24 inside back cover.

**Ruggedized TV Camera.** General Precision Laboratory Inc., 63 Bedford Road, Pleasantville, N. Y. The ruggedized tv camera, model PD-152, capable of operating successfully in extreme noise, shock, temperature and vibration environments, is fully described in a new specification sheet. Its design details and features, which make it highly suitable for automotive testing, wind tunnel and military applications, are outlined. Also

listed are environmental capabilities and performance specifications. **Circle L25 inside back cover.**

**TV Picture Tube Guide.** General Electric Co., 1 River Road, Schenectady 5, N. Y., has available a new edition of its quick selection guide for tv picture tubes (ETD-1001C).

The purpose of this booklet is to help designers select a particular tube from the large number of types now on the market. It classifies each of the 211 tube types by size, bulb structure and deflection angle, and lists the following information: whether it is aluminized or not, external conductive coating capacitance, type of ion-trap magnet, face, dimensions and style of anode terminal. **Circle L26 inside back cover.**

**Custom Transformers.** Nothelfer Winding Laboratories, Inc., 111 Albemarle Ave., Trenton, N. J. A 2-color 26-page catalog describes and illustrates a great variety of customer transformers together with engineering specifications. Under the regular units are listed open frame transformers, cased transformers and channel frame and end bell cased units. The special units comprise air core reactors, special heater transformers and special output transformers. The catalog includes price lists and formulas for computing prices, as well as specifications and diagrams. **Circle L27 inside back cover.**

**Electronics Data Handbook.** Allied Radio Corp., 100 N. Western Ave., Chicago 80, Ill., has released a new 64-page "Electronics Data Handbook" that consists of a carefully selected collection of the most often needed formulas and data used in radio and industrial electronics. Formulas include those needed for basic circuit analysis, transmission line calculations, determination of v-t characteristics, resonance calculations, meter calculations and so on.

Included are up-to-date RETMA and military specifications for resistors and capacitors, coil winding data, wire gage data, decimal equivalents of fractions, logarithms and trigonometric func-

# CIRCUIT

INSTRUMENTS INC.

## helical

# POTENTIOMETERS

## carry a lot of power for their size



**You'll find these Type HM Potentiometers are big in one way; small in another. And that pretty well describes CIRCUIT INSTRUMENTS too. This progressive company is big enough to engineer advanced potentiometers and special features. At the same time, it's small enough to offer unusual production flexibility. You get the benefit in better service and faster delivery.**

**TYPE HM POTENTIOMETER**

**THE OUTPUT YOU WANT...**  
with resistances from 1,000 to 100,000 ohms, tolerances from  $\pm 5\%$  to  $\pm 0.5\%$ , linearities from  $\pm 0.5\%$  to  $\pm 0.1\%$ , 5 or 10 turn models, and power ratings of 3 or 4 watts.

**THE SIZE YOU WANT...**  
a mere 1" in diameter by  $\frac{3}{4}$ " or  $1\frac{1}{2}$ " in case length. To meet installation requirements, Type HM Potentiometers are also available with flexible or turret type terminals and standard or slotted shafts.

(actual size)

# CIRCUIT

INSTRUMENTS INC.

Subsidiary of

INTERNATIONAL RESISTANCE CO.

**CIRCUIT INSTRUMENTS INC.** Dept. E  
P.O. Box 1438, 2801 Anvil St., North St. Petersburg 1, Florida  
Send data sheets on Helical  Sub-Miniature  Servo   
Moisture Sealed  Hermetically Sealed  High Temperature   
High Precision  Potentiometers.

NAME \_\_\_\_\_

COMPANY \_\_\_\_\_

ADDRESS \_\_\_\_\_

CITY \_\_\_\_\_ STATE \_\_\_\_\_

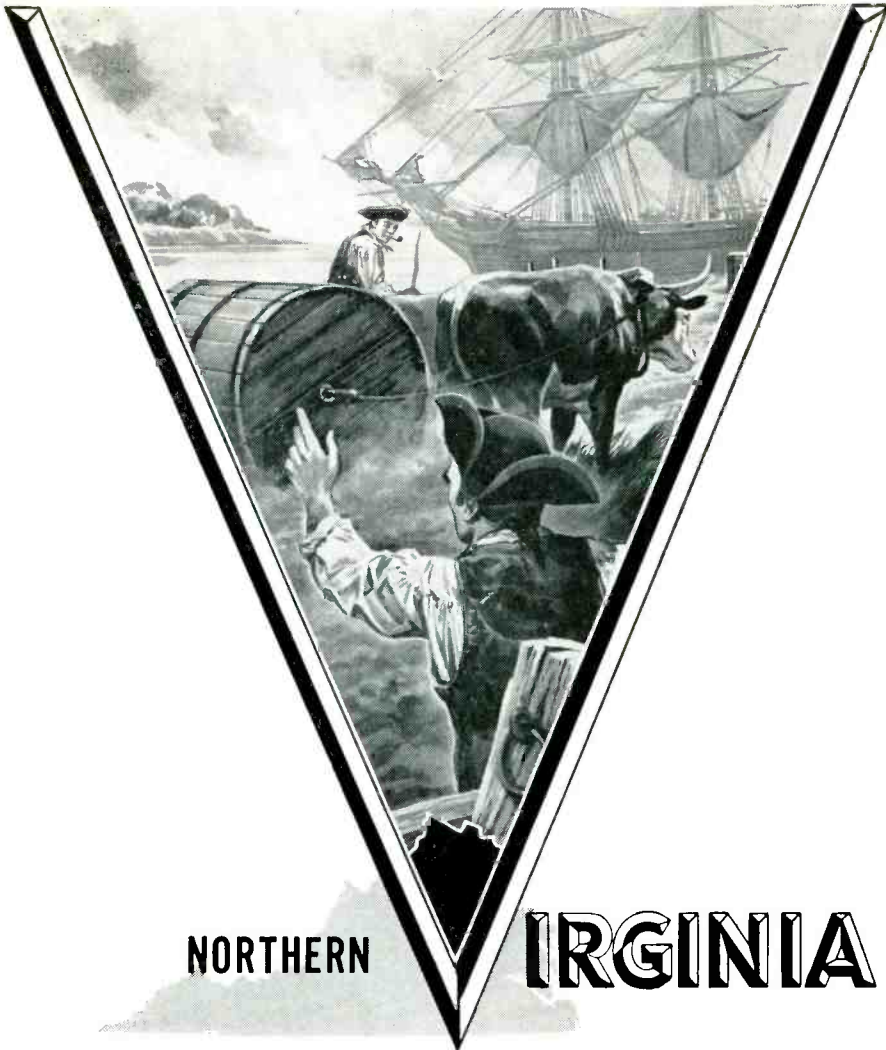

NORTHERN

IRGINIA

## WHERE PLANTERS ONCE "ROLLED THEIR OWN!"

... top transportation now serves industry

**IN GEORGE WASHINGTON'S DAY**, huge hogsheads with axles rolled leaf tobacco from plantation to wharf in Northern Virginia. Today, this fast growing industrial area is the rail, highway and air crossroads of the East Coast. And a deep river channel brings ocean freighters 150 miles inland.

**PLUS FACTORS FOR YOUR PLANT** include nearness to the Nation's Capital, with its great research facilities. You're at the strategic midway point of the eastern market, with favorable freight rates to the Midwest. You live and work in a mild,



no-shut-down climate. And you can draw on a growing force of conservative, Southern manpower.

**ABUNDANT ELECTRICITY** at low cost flows from VEPCO's modern power network. During 1955, generating capacity was expanded by 300,000 kilowatts... with another 300,000 under construction and ready soon. For full facts on low taxes and industrial zoning... or for complete confidential help with your industrial home hunting, write or telephone VEPCO, serving THE TOP OF THE SOUTH.

### VIRGINIA ELECTRIC and POWER COMPANY

Clark P. Spellman, Director—Area Development  
Electric Building, Richmond 9, Virginia • Phone: 3-4261

tions. The book is priced at 35 cents postpaid. **Circle L28 inside back cover.**

**Remote Metering System.** Sparton Controls Systems Division, Jackson, Mich. A new bulletin describes features, applications and future expansion provisions of a simple remote metering system with plug-in construction. The system discussed employs transducers and an electronic bridge circuit, with overall accuracy of better than 2 percent. **Circle L29 inside back cover.**

**Transmitting Tube Manual.** Radio Corp. of America, Harrison, N. J. The 256-page transmitting tube manual is a comprehensive and authoritative book containing technical data on 112 types of power tubes having plate-input ratings up to 4 kw and on 13 types of associated rectifier tubes. Maximum ratings, operating values, characteristics curves, outline drawings, and socket-connection diagrams are given.

This manual contains 16 circuit diagrams showing the use of RCA tubes in representative transmitting and industrial applications. Price of manual TT4 is \$1.00. **Circle L30 inside back cover.**

**Adjustable D-C Resistors.** Leeds & Northrup Co., 4934 Stenton Ave., Philadelphia 44, Pa. A new 2-page data sheet EB2(2) describes adjustable d-c resistors. The new 1-megohm resistance and conductance standard is completely described, specifications are given and a schematic diagram of the instrument is included.

The 4775 and 4776 enclosed-switch resistance boxes and the 4247 tenth-megohm resistance standard are discussed, and their specifications and ordering instructions are given. **Circle L31 inside back cover.**

**Waveguide Ferrite Isolator.** Hewlett-Packard Co., 3808A Page Mill Road, Palo Alto, Calif. A recent specification sheet covers the X365A broadband X-band isolator which covers 8.2 to 12.4 kmc. Principle of operation, typical applications and specifications are

included. Circle L32 inside back cover.

**D-C Power Supply.** Servo Corp. of America, 20-20 Jericho Turnpike, New Hyde Park, L. I., N. Y. A 2-page brochure provides electrical and physical specifications for the model PS-503, a 5,000 v d-c power supply that is ideal for applications where size and weight must be kept to a minimum. The unit described weighs only 2 lb and measures 4 in. by 2½ in. by 5½ in. Input of 275 v d-c provides 5,000 v d-c at 300 µa. Circle L33 inside back cover.

**Photoelectric Controls.** Electronics Corp. of America, One Memorial Drive, Cambridge 42, Mass. Bulletin PA561 is a 24-page illustrated brochure containing detailed specifications, complete descriptive data and operational charts on the company's packaged photoelectric systems for industrial control applications, including conveyor control, counting, inspecting and sorting, smoke detection and high-temperature measurement and control.

Introduced for the first time is a completely new line of miniature and subminiature photoelectric receivers and light sources which make possible many new control applications on special machinery and wherever space is limited. Circle L34 inside back cover.

**Transistor Design.** General Electric Co., Syracuse, N. Y. A new package of brochures contains complete specification information on the company's standard, high performance entertainment transistors and application notes on transistor audio amplifiers. The information contained in the brochures is designed to assist radio engineers in selecting the proper transistors, either *npn* or *ppn*, for any degree of performance desired in a 4, 5 or 6 transistor radio.

Publication No. GP-71 includes performance curves showing typical power gain of the transistors for class A and class B amplifiers using 6, 9 and 12 v power supplies. In addition, the application notes contain design charts for specifying transformers for class



# NEW LP-1a



## PANORAMIC SONIC ANALYZER LP-1a

provides extended versatility and flexibility for accurate analysis of sounds, vibrations, audio waveforms.

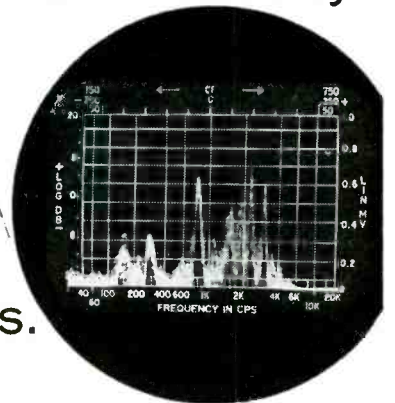

Featuring an additional mode of operation, the new Model LP-1a Panoramic Sonic Analyzer is designed to operate with an optional companion recorder permitting permanent recordings of waveform content over extended periods with significantly greater resolution.

### SUMMARY DETAILS

- **Frequency Range:** 40 cps-20 kc logarithmic or any 5 kc, 1 kc or 200 cps linear segment centered anywhere between 0 cps and 20 kc.
- **Scanning Periods:** 1 second (internal), 10 seconds, 3 minutes or 18 minutes (derived from recorder); usable only in linear frequency scan.
- **Resolution:** optimum dynamic on 1 second scan; static on 18 minute scan.

Find out today how LP-1a can speed up your laboratory and production operations; enable you to complete engineering projects with present personnel.

Write for descriptive data sheets, prices and delivery schedules.

Panoramic Engineers are always available for discussion of SPECTRUM ANALYSIS problems. Special instruments to order.

10 S. Second Ave., Mount Vernon, N. Y.  
Phone: MOUNT VERNON 4-3970  
Cables: PANORAMIC, Mt. Vernon, N. Y. State



# Kearfott

## FERRITE

### MICROWAVE COMPONENTS

#### KEARFOTT FERRITE DUPLEXERS

Improvements in recovery time, reduction in insertion loss and excellent magnetron isolation are performance benefits offered by Kearfott Ferrite Duplexers — designed to meet specific radar space requirements.



A Faraday rotation type unit is illustrated. A type and configuration is available for your requirements.

#### KEARFOTT FERRITE ISOLATORS

For superior performance KEARFOTT ISOLATORS custom designed to fit the exact combination of characteristics, available space and configuration for your radar system. For high or low power — for broad or narrow band use and with db ratios of isolation to insertion up to 150 to 1.

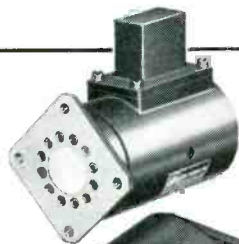

FARADAY  
ROTATION  
ISOLATOR



DIFFERENTIAL  
ABSORBER  
ISOLATOR



DIFFERENTIAL  
PHASE SHIFT  
ISOLATOR

Kearfott offers 3 types of Ferrite Isolators to assure the optimum performance of all microwave applications.

#### KEARFOTT FERRITE ATTENUATORS AND SWITCHES

Ferrites offer new circuit possibilities and product improvement for AGC and electronic switching of R.F. energy. Kearfott designs, precisely tailored to your most exacting requirements, assure maximum performance and reliability with minimum weight.



The 30 db variable attenuator illustrated, requires less than 3 watts control power.

Write for Bulletin W-103 which gives full details of these Ferrite Microwave components.

*Kearfott's complete Microwave engineering and fabrication facilities are at your command. Inquiries on your Microwave problems will be treated in confidence.*

# Kearfott

**COMPANY, INC.**  
LITTLE FALLS, NEW JERSEY  
WESTERN DIVISION  
253 VINEDO AVE., PASADENA, CALIF.

EASTERN OFFICE  
1378 Main Ave.  
Clifton, N. J.

MIDWEST OFFICE  
188 W. Randolph St.  
Chicago, Ill.

SOUTH CENTRAL OFFICE  
6115 Denton Drive  
Dallas, Texas

A and class B output stages and many other helpful curves. Circle L35 inside back cover.

**Magnetic Field Control System.** Nuclear Magnetics Corp., 154 Boylston St., Boston, Mass. A 4-page brochure on the NUMAR model C-1 magnetic field control system, a precision regulator for the stabilization and control of electromagnetic fields, is now available.

The system described is designed to be an automatic electromagnet control for mass spectrometers either singly or in tandem, high-energy particle accelerators, cyclotrons, beta-ray spectrometers, microwave spectroscopy magnets and other laboratory instruments utilizing magnetic fields.

Operation is designed and specifications are listed. Circle L36 inside back cover.

**Variable Vacuum Capacitors.** Vacap Corp., 1905 Summit Ave., Union City, N. J., has ready a new specification sheet on high rated variable vacuum capacitors that feature rugged construction using Pyrex glass bulbs, OFHC copper seals and cylinders. Current ratings, application notes and dimensional drawings are included. Circle L37 inside back cover.

**Worm-and-Gear Speed Reducers.** Rampe Mfg. Co., Cleveland 10, Ohio, has available a data sheet illustrating and describing worm-and-gear speed reducers for fractional horsepower motors. Chief features and horsepower ratings for the model SW-1 are included. Circle L38 inside back cover.

**Power Rectifiers and Control Tubes.** General Electric Co., 1 River Road, Schenectady, N. Y. A selection chart (ETD-1322) listing the essential characteristics of 75 power rectifiers and control tubes is now available.

It classifies 46 thyratrons according to type, lists anode and cathode current and voltage ratings, and gives the average control characteristics of each tube.

Twenty-nine ignitrons are listed according to classification—weld-



ing-control tubes, frequency-changer welding tubes and power rectifier tubes. The chart also lists maximum ratings of each ignitron. Circle L39 inside back cover.

**Automatic Photo Printer.** PSC Applied Research Ltd., 1500 O'Connor Drive, Toronto, Canada. Release No. 27 illustrates and describes the type T231 automatic electronic photo printer. The technique described uses electronic control in dodging the negative during printing. Variations of density in the negatives are sensed and evaluated in special electronic circuits. These circuits compare the light value provided with that actually required to give the best possible print for the photo printing material in use. This information is fed back instantaneously to control the intensity of the printing beam; and in so doing automatically and correctly exposes each small area of the negative.

Specifications and general data are given in the release. Circle L40 inside back cover.

**Ceramic Capacitors.** Skottie Electronics, Inc., Peckville, Pa., has published a catalog describing their line of ceramic capacitors.

The manufacturer offers a complete selection of disk, tubular, and plate types designed to suit every application for temperature compensating, stable capacitance, high voltage, printed circuitry, and special customized applications.

The ceramics described are intended for use in circuits where capacitance must not change with changes in temperature such as in critical r-f tuning and resonant circuit applications. Circle L41 inside back cover.

**Spot Welder.** Sciaky Bros., Inc., 4915 West 67th St., Chicago, Ill. Bulletin 339 completely describes a four function spot welder featuring the company's new pre-determined electronic welder control to cover a wide range of aircraft and other rigid welding specifications.

The bulletin reveals the various circuits employed with this new

From **DIALCO**—New, Compact

# OIL TIGHT INDICATOR LIGHTS

for heavy duty industrial applications

## OIL TIGHT DUST TIGHT OMNIDIRECTIONAL

### Exceptionally Rugged!

Perfect oil-tightness is effected by retained oil-proof gaskets and the gasketed glass lens assembly.

These units have many heavy-duty features: *One-piece solid brass bushing, solid brass lens holder, high impact phenolic insulation, rugged binding screw terminals.*

They install easily in a single 1" or 1 1/16" panel mounting hole. Other units available for 1 1/4" mounting hole. A choice of 3 lens styles, 7 lens colors, and other optional features provide adaptability. If you have an unusual problem, consult our engineering department.

**DISCS** with legends, behind flat lenses, deliver specific messages.



No. 103-3502-1331



No. 103-3502-1211



No. 104-3502-XPIC-231

Illustrations are approx. actual size

## OIL TIGHT INDICATOR LIGHTS

accommodate a wide range of Incandescent and Neon Glow Lamps. For neon, DIALCO offers an exclusive feature — **BUILT-IN RESISTORS** (U. S. Patent No. 2,421,321) for operation on 105-125 V, or 210-250 V. Simple external resistors are provided for all higher voltages. **EVERY ASSEMBLY IS AVAILABLE COMPLETE WITH LAMP.** For design purposes we will send :

### SAMPLES ON REQUEST—AT ONCE—NO CHARGE

**CATALOG "L-200"** gives you complete specs on DIALCO'S Oil-Tight Indicator Lights. Also available—a file of Special Catalogs on DIALCO Pilot Lights covering every indication requirement.

**FREE** — Brochure on "Selection and Application of Pilot Lights".

Foremost  
Manufacturer  
of Pilot Lights



**DIALIGHT**  
CORPORATION

58 STEWART AVENUE  
BROOKLYN 37, N. Y.  
HYACINTH 7-7600

DIALIGHT CORP., 58 Stewart Ave. Brooklyn 37, N. Y.

- Please send Cat. "L-200" on Oil-Tight Lights
- "Selection" Brochure.  Pilot Light Catalogs.

Name \_\_\_\_\_

Company \_\_\_\_\_

Address \_\_\_\_\_

City \_\_\_\_\_ State \_\_\_\_\_



why  
design  
your  
own

## COAXIAL CRYSTAL MIXERS

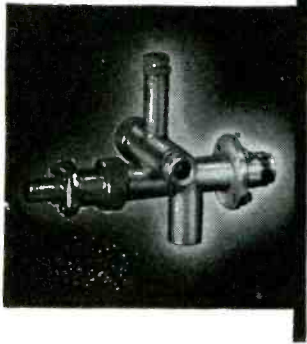
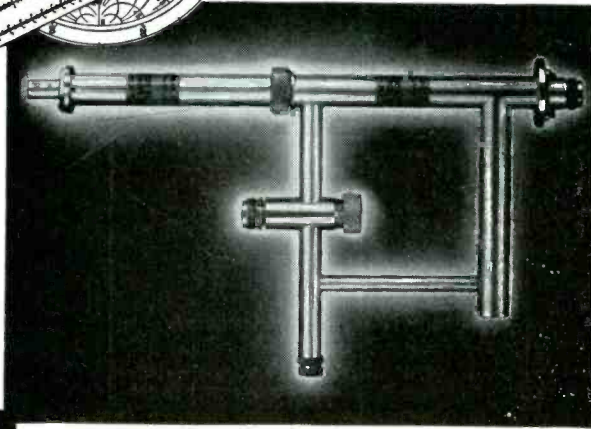
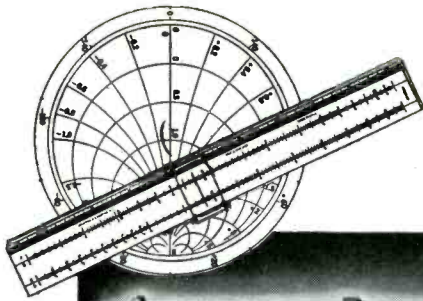

**...you can buy them from stock!**

Save time... reduce costs... avoid design headaches. Empire Devices offers a wide variety of standard broad band, fixed tuned coaxial crystal mixers to meet your needs. Specialized manufacturing facilities and techniques result in economy, and a high degree of quality control by competent engineers assures uniformity in manufacture. Immediate delivery in many instances.

Select one of 8 models in the CM-107 Series, covering the entire frequency range from 225 to 5600 mc. Input VSWR of any crystal mixer in the line is better than 2:1, without adjustments, for all frequencies within its rated range. Local oscillator input requires 10 milliwatts, has a VSWR of 2:1 or better with any injector adjustment. A choice of input connectors is available. Standard models can be modified for special purposes!

For complete engineering data, ask for our free catalog C-356.

NEW YORK—Digby 9-1240 • SYRACUSE—Syracuse 2-6253 • PHILADELPHIA—Sherwood 7-9080 • BOSTON—Twinbrook 4-1955 • WASHINGTON, D. C.—Decatur 2-8000 • ATLANTA—Exchange 7801 • DETROIT—Broadway 3-2900 • CLEVELAND—Evergreen 2-4114 • DAYTON—Fulton 8794 • CHICAGO—EStebrook 9-2700 • DENVER—Main 3-0343 • FORT WORTH—WAlnut 3-8811 • ALBUQUERQUE—Albuquerque 5-9632 • LOS ANGELES—Republic 2-8103 • PALO ALTO—Davenport 3-4455 • EXPORT: NEW YORK—Murray Hill 2-3760

### EMPIRE DEVICES PRODUCTS CORPORATION

38-15 BELL BOULEVARD • BAYSIDE 61 • NEW YORK

manufacturers of

FIELD INTENSITY METERS • DISTORTION ANALYZERS • IMPULSE GENERATORS • COAXIAL ATTENUATORS • CRYSTAL MIXERS

type Dekatron tube control. With the assistance of various illustrations and a block diagram, the four functions spot welder is simply and effectively explained. Circle L42 inside back cover.

**Data Processing Systems.** Consolidated Electrodynamics Corp., 300 N. Sierra Madre Villa, Pasadena, Calif. Bulletin 3003A is an 8-page folder covering the Millisadic data processing systems. Unit and component data, systems tabular material and ordering information are included. Circle L43 inside back cover.

**Oscilloscope.** Hewlett-Packard Co., 275 Page Mill Rd., Palo Alto, Calif. Volume 7, No. 8 of the *Journal* covers a new d-c to 10-mc oscilloscope with dual-trace and high-gain preamplifiers. A well-illustrated article and technical specifications are included. Circle L44 inside back cover.

**Cable Trough and Accessories.** P-W Industries, Inc., Duncan & Melrose Sts., Philadelphia 24, Pa. Bulletin No. 256-F (12 pages) fully describes cable trough and accessories for holding cables for all industries. The channel connector, extension connector and adjustable connectors, for any change in direction or elevation, eliminate all field cutting and offer a strong, versatile and easily assembled system. The trough described is supplied in various widths and lengths to meet requirements in the field. Circle L45 inside back cover.

**H-F Capacitors.** General Electric Co., Schenectady 5, N. Y. High-frequency Pyranol capacitors, generally designed for power-factor improvement in circuits operating at frequencies from 500 to 12,000 cps, are described in a new 4-page bulletin.

The majority of applications of the h-f capacitors described are with induction heating equipment for melting, forging and hardening operations. The capacitors discussed are also used for series application on the load side of a h-f generator, where they supply a reactive component to the gen-

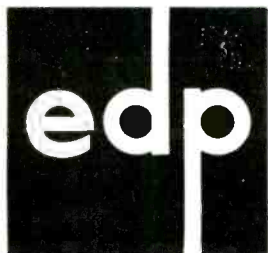

# RAWSON ELECTROSTATIC VOLTMETERS

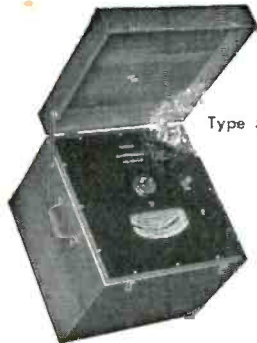

Type 518

Available ranges 100 volts to  
35,000 volts

Measure true R.M.S. values on A.C., no wave-  
form or frequency errors.

### NO POWER CONSUMPTION

Leakage resistance greater than one million  
megohms. These meters may be used to  
measure STATIC ELECTRICITY!

Ideal for measuring high voltage power sup-  
plies with zero current drain. Rugged, well-  
damped movement. All elements surrounded  
by metal shielding for accuracy and safety.

Write for bulletin

**RAWSON ELECTRICAL  
INSTRUMENT CO.**

111 POTTER ST. CAMBRIDGE, MASS.

## Wanted:

by the industry's leading technical literature specialists

## MANUALS

of the most superior quality

## TO PRODUCE

most quickly and economically

The professional organization producing the greatest volume of technical literature in the electronics field is now available to you. We have complete facilities for organizing, writing and illustrating your operating and maintenance manuals for equipment—or any technical literature you may require—at substantial savings in time and money. Complete production and printing facilities are a part of our integrated operation. Your inquiries are cordially invited.

call or write **HOWARD W. SAMS & CO., INC.**

Special Services Division, 2201 E. 46th St., Indianapolis 5 • Phone: Glendale 4531

Ask  
for it

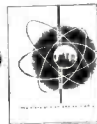

We'd like to send  
you our brochure:  
"The Story of a  
Unique Service"

**SILICON AND GERMANIUM  
CRYSTAL GROWING AND  
REFINING EQUIPMENT**

**SINGLE-CRYSTAL GERMANIUM**  
N-type and P-type  
for diode and transistor applications

**SINGLE-CRYSTAL SILICON**  
for diode and transistor applications

**SEMIMETALS, INC.**  
130-11 90th Avenue  
Richmond Hill 18 New York, U.S.A.

HIGH PRODUCTION,  
PRECISION,

# GENERAL

SILK SCREEN  
PRINTING

\*Electronic Circuits  
\*Nameplates \*Dials...

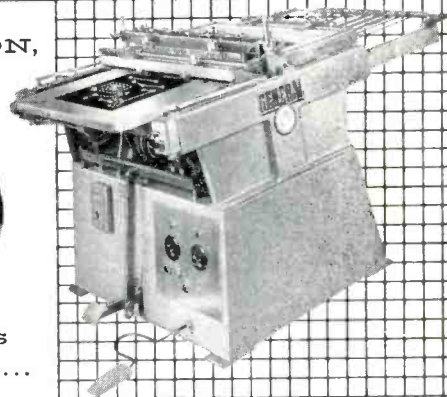

## GENERAL

DECORATOR PRESSES—SERIES "B"

A new General precision built screen  
process press, especially adapted to the  
high volume production of printed  
circuits, nameplates and dials.

Incorporates a new and completely  
different approach to the handling of  
many difficult materials. Precision  
register assures proper placement of  
print on panel and accurate backing-up  
of two-sided circuits. Heavy deposits of

plating and acid resists can be laid down  
assuring quality printed circuit results.  
Fine lines print clean and sharp and the  
enamel effect required in the manufacture  
of nameplates and dials is effectively  
reproduced. Work can be both fed and  
delivered at front of press, or delivered  
at rear for in-line operation with the  
General Thermo-Jet Dryer, or other  
drying equipment.

Model	Sheet Size	Speeds Up To
B1224	13"x25"	1000 iph
B2230	22"x30"	800 iph
B2236	22"x36"	800 iph

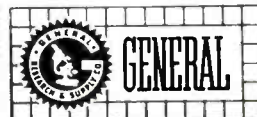

Write for  
complete information!  
**RESEARCH & SUPPLY CO.**  
572 S. Division Avenue  
Grand Rapids 3, Michigan

# POLYPENCO® **TEFLON\*** SHAPES

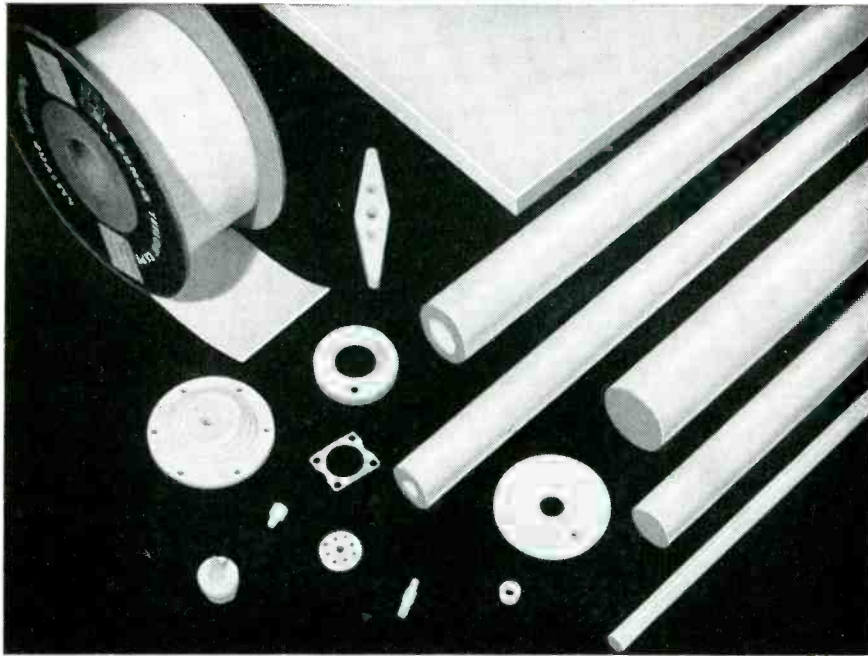

## For electronic components: high quality Teflon plus low-cost fabrication

No other material is proving so versatile in the electronics and electrical field as Teflon. It is now widely used for insulating bushings, terminal connectors, stand-off insulators and many other parts as its applications continue to expand.

### TEFLON'S OUTSTANDING PROPERTIES

Dielectric Constant.....	2.0
Power Factor.....	0.0005
Dielectric Strength, volts/mil.....	400-500
Surface Resistivity (100% R.H.) megohms.....	$3.6 \times 10^9$
Temperature Range.....	-110°F. to +500°F.
Water Absorption.....	nil
Chemical Resistance.....	excellent

### FABRICATION FROM STANDARD SHAPES

POLYPENCO Teflon Shapes are available in rod, tubular bar, tape, slab and flexible tubing—in a wide range of sizes—for fast, easy machining to close tolerances on standard metalworking tools or automatic equipment.

### POLYPENCO TEFLON MEANS QUALITY

In order after order, POLYPENCO Teflon comes to you with uniform, controlled density and maximum dimensional stability. Stock sizes available for immediate delivery from distribution locations throughout the country.

Take this first step toward a more efficient, economical solution to your design problems. Write today for latest technical data.

THE POLYMER CORPORATION OF PENNA. • Reading, Penna.  
Export: Polypenco, Inc., Reading, Penna., U. S. A.



**POLYPENCO®**

Nylon, Teflon†, Q-200.5 (cross-linked polystyrene) and K-51 (chlorinated polymer)

\* PATENTS APPLIED FOR  
† DU PONT TRADEMARK

NEW LITERATURE

(continued)

erator windings and tend to neutralize its reactance. **Circle L46 inside back cover.**

**Fluorocarbon Products.** The M. W. Kellogg Co., P. O. Box 469, Jersey City 3, N. J. The forms, properties and uses of a wide range of fluorocarbon products—from plastic resins to acids and dielectric fluids—are described in a new 8-page brochure.

Detailed in the booklet are the types and grades available of each form of KEL-F fluorocarbon products and their suggested uses. **Circle L47 inside back cover.**

**Power Supply.** EECO Production Co., 506 East First St., Santa Ana, Calif., has published a bulletin on its Z-95000 series power supplies which are designed specifically for the user of the company's plug-in circuits. Illustrations, specifications and prices are included. **Circle L48 inside back cover.**

**Voltage Stabilizing Transformer.** General Electric Co., Schenectady 5, N. Y. Bulletin GEA-5754C is a 16-page publication giving the voltage stabilizing transformer's features and data on where to use the equipment. The 2-color booklet includes operating characteristics and specifications. It is illustrated with application pictures as well as wiring diagrams and performance graphs. **Circle L49 inside back cover.**

**Precision Potentiometer.** Helipot Corp., 916 Meridian Ave., South Pasadena, Calif. The new 3-in. diameter series 5700 precision potentiometer is the subject of data sheet 54-66. A single-turn, continuous-rotation unit for servo or bushing mounting, the series 5700 combines a wide range of total resistance and close linearity characteristics.

The data sheet is illustrated and lists specifications, construction, coil characteristics and available modifications. **Circle L50 inside back cover.**

**Electrolytic Grinding.** Anocut Engineering Co., 631 W. Washington Blvd., Chicago 6, Ill. Engineering

bulletin No. 300 is titled "Suggestions for Modification of Standard Grinding Machinery to Anocut Electrolytic Grinding Equipment." It clearly outlines the procedures in adapting any standard grinder for use with the company's process.

Complete with cutaways, exploded views and parts recommendations this bulletin contains much to interest anyone who contemplates the use of electrolytic grinding. Circle L51 inside back cover.

**Toroid Catalog.** Burnell & Co., Inc., 5 Warburton Ave., Yonkers 2, N. Y., announces a 16-page catalog which describes its complete line of wound toroids, including standards, miniature, subminiature and h-f toroids; Adjustoroids, Rotoroids, telemetering band-pass filters, miniaturized band-pass filters, communications filters and sideband filters.

These toroids are available in a wide range of finishes. The company's filters and networks are also available in a wide range of case types.

The new catalog fully describes the various characteristics and uses of each of the toroids or filters, and is well-illustrated with photographs. Performance curves for inductance changes with d-c are given for each product, as well as charts and graphs illustrating inductance values and ranges. Circle L52 inside back cover.

**Toroidal Winding Machine.** Arnold Magnetics Co., 5962 Smiley Drive, Culver City, Calif. A 4-page bulletin illustrates and describes a machine which, in one compact design, winds toroidal coils for both laboratory and production use, with substantial savings in time, labor and wire. Specifications and applications are included. Price of the unit described complete with all accessories, both counters, set of three winding rings and sliders, set of nylon inserts, and foot rheostat is \$1,200. Circle L53 inside back cover.

**Engineering Data Wall Chart.** Perkin Engineering Corp., 345

# NEW SHIELDING'S UNIVERSAL ENCLOSURE

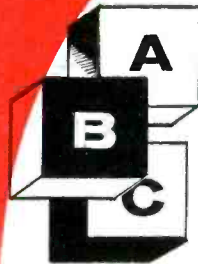

## EASY TO INSTALL

A Shielding Universal Enclosure can now be erected by using **only a screwdriver!** . . . saves time and labor costs . . . your choice of modular panels of single or double shielding.

Both cell and isolated type enclosures are now available . . . at your request. Enclosures can be constructed of 40 or 48 inch wide panels and in combinations of both . . . standard door can be installed in any wall position to open left or right, in or out.

Completely interchangeable standard panels can be supplied with either **solid and/or mesh material.** Construction design insures maximum shielding effectiveness for any material specified. For complying with Mil-I-16910 and Mil-I-6181B radio interference specs, Shielding's Universal enclosures provide the quick, correct solution to your particular shielding and erection problem.

**"The Talent to Create,  
the Skill to Produce"**

Write today  
for illustrated  
booklet

# SHIELDING INC.

Dept. E-2 • Box 217 • RIVERSIDE, NEW JERSEY

In Chicago, R. W. Stemm In Canada, MJS Sales Ltd.

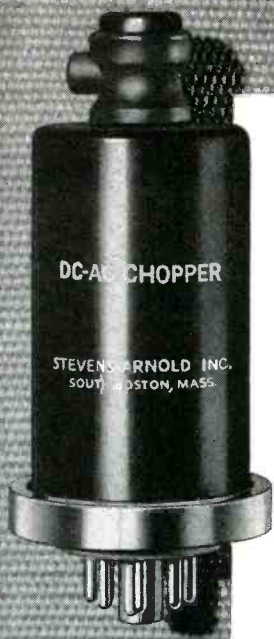

## DC-AC CHOPPERS

**For 60 Cycle Use**

Built to rigid commercial specifications.

Twenty-two types, both single and double pole.

Long life.

Low noise level.

Extreme reliability.

Write for Catalog 370.

**STEVENS  
INCORPORATED  
ARNOLD**

22 ELKINS STREET  
SOUTH BOSTON 27, MASS.



S/A-10

Kansas St., El Segundo, Calif., has available a useful engineering data wall chart dealing with power supplies and a-c line regulators. It gives tables on decimal equivalents, temperature conversion, wire size and current ratings, mechanical and electrical conversion. Request the chart on company letterhead. **Circle L54 inside back cover.**

**Panel Instruments.** Weston Electrical Instrument Corp., a subsidiary of Daystrom, Inc., 614 Frelinghuysen Ave., Newark 5, N. J. A new bulletin (A-7-F) covers the more popular styles and ranges of panel instruments in sizes from 2½ in. to 4¾ in. It contains complete specifications on all a-c and d-c instruments including rectifier type a-c and thermo instruments; as well as on power level meters; VU and db meters, frequency meters and wattmeters. Also included are dimensional diagrams, typical full size scales, and detail data on instruments for h-f measurements. **Circle L55 inside back cover.**

## Electroplated WIRE

*For Many Different Applications*



**Specialists in the Unusual**

More and more people are turning to us for electroplated wire. We electroplate by continuous methods a wide variety of wire in a range of diameters from .035" to the smallest available. In our laboratory, Tungsten wire as small as .00015" has been electroplated with Gold . . . New applications for electroplated wires on different base materials are being developed from time to time . . .

Your inquiry is invited. Consult our staff, without obligation, about your specific wire problems.

**SIGMUND COHN MFG. CO., INC.**  
121 SOUTH COLUMBUS AVENUE, MOUNT VERNON, N. Y.

 SINCE 1901

Write for List of Products.

**Copper Clad Data.** Formica Corp., 4614 Spring Grove Ave., Cincinnati 32, Ohio, has released a new 16-page copper clad technical data book. The brochure will be of great value to electronics manufacturers making their own printed circuits, since it explains the principles and some of the problems of printed circuitry. It advises on the proper selection of laminates, and tells how to make a printed circuit using both the photoengraving and silk screen methods. It also covers the subjects of plated circuits, plating through holes, flush circuit production and circuit fabricating.

The booklet is amply illustrated with photos, data sheets and comparator charts. **Circle L56 inside back cover.**

**Recording and Controlling.** Fielden Instrument Division, Robertshaw-Fulton Controls Co., 2920 North Fourth St., Philadelphia 33, Pa. A new approach to recording, indicating and controlling instruments required in industrial processing, is described in a 4-page bulletin. The systems described

feature four basic components that can be interchanged to perform a variety of functions, as well as minimize maintenance problems.

The publication is designed as bulletin No. F-403. Circle L57 inside back cover.

**Pulse Patterns for Testing Cores.** Burroughs Corp., 1209 Vine St., Philadelphia 7, Pa. Bulletin 136, "Pulse Patterns For Testing Cores," provides helpful information on how both manufacturers and users of tape-wound or ferrite cores can benefit from using the company's pulse control systems to test cores by digital techniques.

The 16-page booklet discusses the current state of the core manufacturing art. It proves how reliable testing procedures are a must, and goes on to point out the need for equipment which not only tests how a core will meet specifications within all necessary ranges of tolerance, but also how it will eventually operate in the system for which it is intended. Block diagrams and timing diagrams are included. Circle L58 inside back cover.

**Toroid Coil Winder.** Electro Devices Co., Inc., 580 Main St., Wilmington, Mass., has available a brochure on the MidJet toroid coil winder. It describes the new method of winding off the inside of the shuttle that makes possible the winding of finished coils having an inside diameter of  $\frac{3}{8}$  in.

The brochure also contains full specifications of the wide range of wire sizes possible; the full 360 deg coverage of the core; and the high 200 turns per minute winding speeds. Other features described include: wide range of coil sizes possible; elimination of wire strains; elimination of tensile shock; polished windings guides; and polished vent in the shuttle to prevent kinks and loops. Circle L59 inside back cover.

**Infrared Transmitting Materials.** Servo Corp. of America, 20-20 Jericho Turnpike, New Hyde Park, L. I., N. Y. A key factor in the design of infrared equipment is the bandwidth of infrared trans-

## Precision Frequency Source...

WESCON SHOW  
Booths 508 & 509

### ULTRA STABLE OSCILLATOR

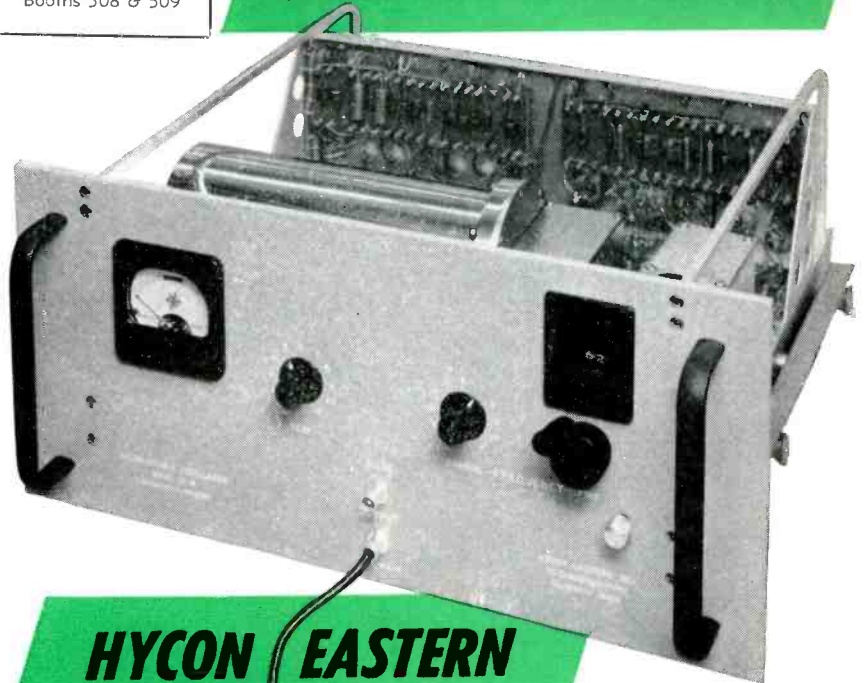

## HYCON EASTERN

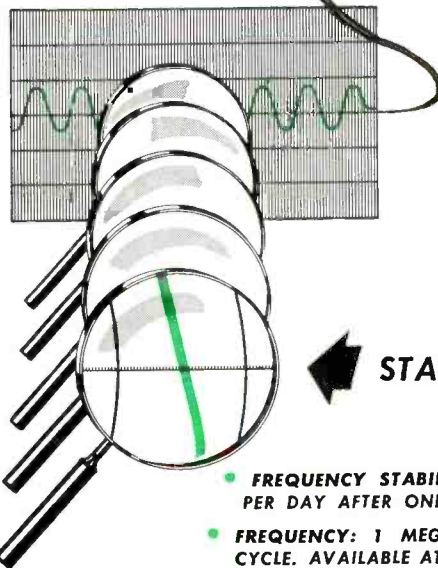

Hycon Eastern's new Ultra Stable Oscillator is a one megacycle signal source of exceptional stability. It is useful wherever precise time measurements or frequency control are required, as in reinsertion of carrier in suppressed carrier systems, telemetry, astronomical measurements, navigation systems, geophysics or other critical applications.

**STABILITY: 1 PART IN  $10^9$**

- **FREQUENCY STABILITY: DRIFT RATE LESS THAN 1 PART IN  $10^9$  PER DAY AFTER ONE MONTH'S OPERATION.**
- **FREQUENCY: 1 MEGACYCLE, VARIABLE OVER A RANGE OF 1 CYCLE. AVAILABLE AT OTHER FREQUENCIES ON SPECIAL ORDER.**
- **CRYSTAL OVEN: STABILIZED TO BETTER THAN  $0.01^\circ\text{C}$  BY TEMPERATURE-SENSITIVE RESISTANCE BRIDGE. OVEN CONTAINS NO MOVING PARTS.**
- **DISSIPATION IN OSCILLATOR CRYSTAL: STABILIZED AT A POWER LEVEL LESS THAN ONE MICROWATT.**
- **2 OUTPUTS: SINE WAVE—4 VOLTS RMS; PULSE—1 VOLT.**
- **OUTPUT IMPEDANCE: APPROXIMATELY 250 OHMS.**

Write for Ultra Stable Oscillator Bulletin



**HYCON EASTERN, INC.**

75 Cambridge Parkway Dept. A-10 Cambridge 42, Mass.  
Affiliated with HYCON MFG. COMPANY, Pasadena, California

with **ERIE**  
**PAC\***



**THIS IS REPLACED**

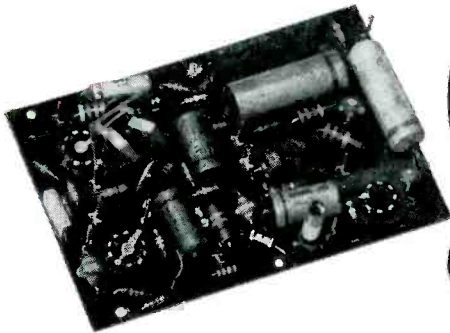

**WITH THIS**

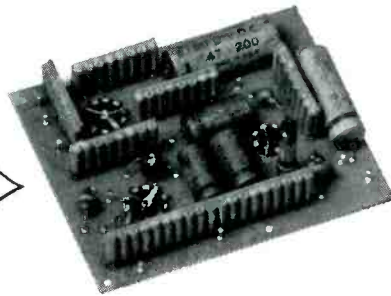

**\*PACKAGED ASSEMBLY CIRCUIT**

**PAC-Facts**

**REDUCED COSTS**

PAC requires fewer insertions. Simplified equipment. Smaller chassis area. Reduced inspections. Fewer items purchased. Fewer chassis holes. Simplified chassis wiring.

**UNIQUE TERMINAL DESIGN**

The ERIE PAC terminal provides a "U" shaped cross section and tapers in both planes to assure easy insertion, self-adjusting—rigid fit, and large contact area.

**FLEXIBILITY**

All Resistance values between 5 ohms and 50 megohms. Wide range of capacitor temperature characteristics. Parallel and series arrangements readily obtained. Excellent circuit flexibility thru use of printed wiring type base.

**REDUCED CHASSIS AREA**

Chassis area is reduced by use of the vertical plane design feature. 15 components per square inch.

Erie's new Packaged Assembly Circuit is able to reduce assembly and labor costs for electronic component users by simplifying automation. By employing standard size resistor and capacitor pins, a PAC module can be assembled simply, automatically, and economically.

PAC will drastically reduce the number of component insertions in TV, radio, computers, and other electronic equipments by combining up to 90 components into one PAC module. The illustration above clearly exemplifies how Erie's Packaged Assembly Circuit will clean up and simplify nearly any printed circuit board. The original conventional design, at left, contains 44 individual components. The electrically equivalent Erie PAC design, at right, contains but 16 individual units—a savings of 64% in the number of insertions.

Experimental PAC Design Kits have been prepared and are available at a moderate cost. The 5% PAC Kit includes 195 different resistance and capacitance values, strips, wiring boards, clips, eyelets, and other material essential for building complete PAC circuits. The 10% PAC Kit contains 105 values along with the other items, and the 20% PAC Kit has 54 values plus equipment. This Design Kit is your key to cost savings.

Write for Erie Engineering Bulletin No. 450-1

mission accepted by the transducer components. Since optical elements are generally critical portions of the infrared system, they must transmit infrared in the proper bandwidth as well as meeting other chemical, physical and mechanical requirements.

A new brochure provides comparative information on 15 different infrared transmitting materials suitable for use as optical elements. Transmission curves are included for the 11 most important materials. Circle L60 inside back cover.

**Scatter Communications System.** Canadian Marconi Co., 2442 Trenton Ave., Montreal 16, Canada, has prepared an illustrated brochure on its latest type radio relay communication equipment for beyond-the-horizon communications. The system described is intended primarily for use over routes of greater distance than optical or quasioptical paths, to carry multi-channel telephone and telegraph traffic.

Less maintenance because of fewer sites; reduced outage time because of quicker access; and terminals easily located near local power supply, are vital factors in assessing the merit of the system discussed in the brochure. Circle L61 inside back cover.

**Test Laboratory.** Electrical Testing Laboratories, Inc., Two East End Ave., New York 21, N. Y., has published a new 72-page bulletin on its services and facilities to enable executives, engineers and others in industry and government to evaluate its capabilities.

The 8½ in. by 11 in. bulletin contains more than 70 photographs and covers typical measurements and determinations made on hundreds of products and materials. It also catalogs laboratory equipment available for limitless assignments in the fields of testing, applied research and engineering analysis.

Also covered in the bulletin is information on such special services as in-plant checks of instruments, test sets and apparatus; audits of testing and quality control procedure; audits of specific

**ERIE**  
TRADE MARK  
*electronics*

**ERIE ELECTRONICS DIVISION**  
**ERIE RESISTOR CORPORATION**  
Main Offices and Factories: ERIE, PA.  
Manufacturing Subsidiaries  
HOLLY SPRINGS, MISSISSIPPI • LONDON, ENGLAND • TRENTON, ONTARIO



cation compliance procedure; and inspection and witness testing of wire, cable, transformers and generators.

Additional services are described. Circle L62 inside back cover.

**Signal Generator and Control System.** Brush Electronics Co., 3405 Perkins Ave., Cleveland 14, Ohio, has published an 8-page folder illustrating and describing its new signal generator and control system. The instrument has been designed with numerous features to meet the varied requirements of a signal source for electrical, electroacoustical and acoustical measurements.

Typical applications for the signal generator described include all a-f response curve measurements, h-f vibration testing, calibration measurements, automatic sound insulation testing, acoustical measurements, and automatic distortion measurements. More than a dozen illustrations augment the text. Circle L63 inside back cover.

**Data System.** Beckman Instruments, Inc., 2500 Fullerton Road, Fullerton, Calif. Bulletin 494 is a 16-page brochure describing model 111 data system. It contains all of the latest information on the system which has been called "the link between sensing elements and computer" in chemical processing industries.

Digital control of the system described is accomplished through use of the Pinboard Programmer—a device which eliminates time-consuming calibration and re-engineering to accommodate changes in process requirements. Other features are also covered in the brochure. Circle L64 inside back cover.

**Loudspeakers.** Jensen Mfg. Co., 6601 South Laramie Ave., Chicago 38, Ill., has released catalog No. 1070 on its new line of Professional Series loudspeakers designed for commercial, industrial, institutional and p-a applications. The catalog contains 24 pages of definitive information on all equipment in the Professional Series line. Circle L65 inside back cover.

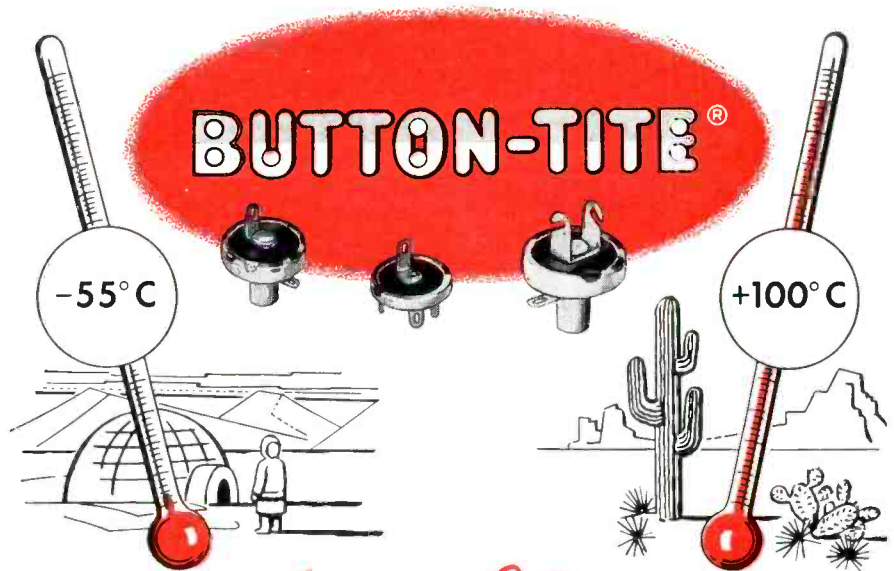

The New "Torture-Tested" Seal

For all  
**ERIE**

**BUTTON<sup>®</sup> Silver-Mica Capacitors**

Button silver-mica capacitors, the world's best high frequency capacitors . . . have been still further improved. ERIE has developed in the laboratory and proven on the production line a new seal — Button-Tite.

The material used for the new Button-Tite seal was subjected to these terrific torture tests before it was approved: From room temperature the buttons are completely submerged in  $-55^{\circ}\text{C}$  alcohol for 5 minutes; removed and immediately plunged into boiling tap water for 5 minutes; removed and immersed in tap water at just above freezing temperature. The surface is dried and the capacitor read for insulation resistance and dielectric strength.

*The Button-Tite is the only known suitable resin seal capable of withstanding this torture test for wet thermal shock.*

Button silver-mica capacitors, coated with Button-Tite, exceed the minimum insulation resistance limit specified under MIL-C-10950A, characteristic "D." They still have the same inherent qualities that have made them superior for many years for Military, Industrial, and Commercial applications. They are available in a wide variety of styles and sizes and have many mounting arrangements.

To provide maximum protection against tarnishing, ERIE packages Button silver-mica capacitors with an anti-tarnish paper in heat-sealed polythelene bags.

Write for Engineering Bulletin fully describing ERIE Button-Tite Seal



**ERIE ELECTRONICS DIVISION**

**ERIE RESISTOR CORPORATION**

Main Offices and Factories: ERIE, PA.  
Manufacturing Subsidiaries

HOLLY SPRINGS, MISSISSIPPI • LONDON, ENGLAND • TRENTON, ONTARIO

# Plants and People

Edited by WILLIAM G. ARNOLD

Electronics scientists named to receive top IRE awards for 1957. Manufacturers add more plant space through mergers, acquisitions and new construction. Industry engineers and executives move to new technical and management posts

## IRE Selects Stratton And Heising For Highest Awards

JULIUS A. STRATTON, Chancellor of the Massachusetts Institute of Technology, has been named to receive the IRE's 1957 Medal of Honor. The award is to be given "for his inspiring leadership and outstanding contributions to the development of radio engineering as a teacher, physicist, engineer, author, and administrator."

Raymond A. Heising, radio pioneer and consulting engineer, is to receive the Institute's Founders Award which is given only on special occasions to an outstanding leader in the radio industry. It is bestowed on Dr. Heising "for his leadership in Institute affairs, for his contributions to the establishment of the permanent IRE Headquarters, and for originating the Professional Group system."

Presentation of the awards will be made at the annual IRE banquet to be held at the Waldorf-Astoria Hotel, New York, N. Y. on March 20, 1957 during the Institute's national convention.



Julius A. Stratton



Raymond A. Heising

Dr. Stratton joined MIT in 1925 and served on the staff of the electrical engineering and physics departments for 20 years. In 1945 he was appointed head of the Research Laboratory of Electronics. He became vice-president and Provost of MIT in 1949 and this year was appointed to the specially created position of Chancellor.

Dr. Heising was associated with

the Western Electric Co. and Bell Telephone Laboratories from 1914 until his retirement in 1953. He played a major role in the original development of transoceanic and ship-to-shore radio telephone systems for the Bell System and contributed many firsts in this field. He conducted and supervised much research work on ultra-short waves, electronics, piezoelectric crystals.

## Pacific Mercury Expands Electronic Organ Plant

PACIFIC MERCURY TELEVISION MFG. CORP. has increased its Sepulveda, Calif. plant area to 150,000 sq ft. This brings total combined area to over a quarter-million sq ft when added to the firm's Van Nuys, Calif. and Joplin, Mo. operations. The firm employs a total of over 1,200 people.

The company recently entered the electronic organ field and is now producing the Thomas Organ at the Sepulveda plant.

The firm is also subcontractor to a major airframe producer in its Sepulveda plant. Its Joplin facility is designed and dedicated entirely to military work. Expan-

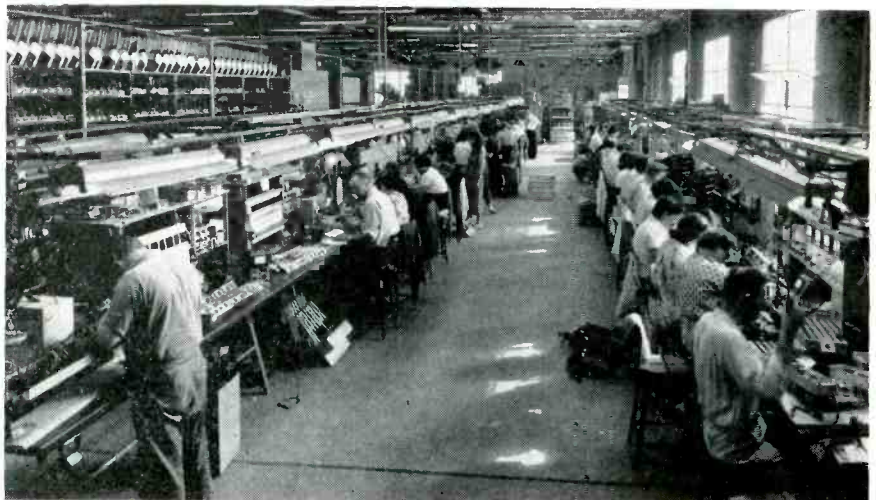

Electronic organ production line at Pacific Mercury's Sepulveda plant



Uses

NATVAR  
Styroflex<sup>®</sup> Film

TO MAINTAIN  
Capacity Tolerance

AND  
Longtime Stability  
IN THEIR  
ADJUSTABLE CAPACITORS

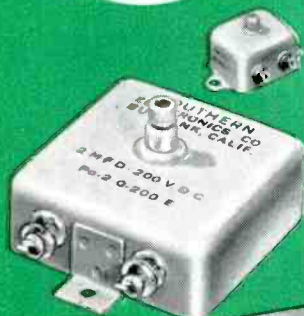

These SEC Polystyrene Capacitors have an accuracy in the order of 0.1% or better and longtime stability in the order of 0.03%. Natvar Styroflex film is used as the dielectric.

SOUTHERN ELECTRONICS CORPORATION, Burbank, California, manufactures precision capacitors for applications where difficult specifications have to be met, such as computer integrators, test equipment, secondary standards and certain weapons programs.

Because polystyrene comes closest to meeting specifications for a perfect dielectric, various polystyrene films were tested. Natvar Styroflex film was selected because of its uniformly excellent pliability, freedom from faults, high shock resistance and excellent dielectric characteristics.

Natvar Styroflex film is available in standard thicknesses from .0004" to .006" in widths from 1/2" to approximately 10" or in special put-ups to meet manufacturing requirements.



### Natvar Products

- Varnished cambric—cloth and tape
- Varnished canvas and duck
- Varnished silk and special rayon
- Varnished—Silicone coated Fiberglas
- Varnished papers—rope and kraft
- Slot cell combinations, Aboglas<sup>®</sup>
- Isoglas<sup>®</sup> sheet, tape, tubing and sleeving
- Vinyl coated—varnished—lacquered tubing and sleeving
- Extruded vinyl tubing and tape
- Styroflex<sup>®</sup> flexible polystyrene tape
- Extruded identification markers

Ask for Catalog No. 23

# NATVAR CORPORATION

FORMERLY THE NATIONAL VARNISHED PRODUCTS CORPORATION  
TELEPHONE  
FULTON 8-8800  
CABLE ADDRESS  
NATVAR: RAHWAY, N. J.

201 RANDOLPH AVENUE • WOODBRIDGE, NEW JERSEY

sion of the present engineering group is planned to increase military electronics work.

## Gulton Acquires Two More Companies

THERMISTOR Corp. of America and Vibro-Ceramics Corp. have merged with Gulton Mfg. Corp. Gulton recently changed its name to Gulton Industries. Thermistor and Vibro-Ceramics will operate as divisions of the new organization, as will Engineered Magnetics of Culver City, Calif., which is presently a division of Gulton Mfg. Corp.

Dr. Leslie K. Gulton, president, said that the merger will increase the coordination of production and engineering of the three companies that previously were affiliated only through advertising and sales policies.

Gulton Industries manufactures electronic, electrical and electromechanical instruments and systems.

## General Instrument Expands In Canada

GENERAL INSTRUMENT CORP. has acquired all the outstanding stock of T. S. Farley, Ltd., of Hamilton, Ont., producer of radio and television coils.

The Farley company will retain its identity and will be operated as a separate division with present personnel retained. Theodore S. Farley, former president, continues with the company as a consultant and Lloyd R. Harris remains as vice-president and general manager.

## National Electronics Conference Set To Open In Chicago

NATIONAL ELECTRONICS CONFERENCE for 1956 will be highlighted by 24 technical sessions and three luncheon addresses in Chicago on Oct. 1 to 3 at the Hotel Sherman.

The tentative program for the 12th annual conference features approximately 100 papers on electronic research, development and application.

More than 10,000 persons are expected to attend the three-day technical meeting and exhibition—having "Fifty Years of Progress

## Varian Builds Plant, Appoints Officers



Watching Dr. Russell Varian break ground for new plant are: left to right: Major General Frank E. Stoner (ret.), director of program planning; Captain W. C. Sprenger, U. S. Navy; Major Louis Wampler, U. S. Air Force and H. Myrl Stearns, executive vice-president and general manager of Varian Associates

WORK has started on a new 80,000 sq ft building for Varian Associates to house the instrument division's administrative, research, production and sales departments. The new building is part of a half million sq ft total planned for completion within the next five years on the firm's 33 acre leasehold in Stanford Industrial Park.

Under a reorganization, Russell Varian, who has served as president of Varian Associates, moves up to chairman of the board and Sigurd Varian, formerly vice-president, engineering, takes over the presidency. In his new post, Dr. R. Varian plans to devote more time to direction of the research activities of the company.

H. Myrl Stearns will continue as executive vice-president and gen-

eral manager and will serve as chief executive officer in charge of all company operations.

Emmet Cameron, formerly vice-president for production has moved up to the new position of vice-president in charge of the tube division. Heading the division's four main operations are: Theodore Moreno, appointed manager, development engineering; Robert Jepsen who continues as director, tube research; Howard Patterson, appointed manager for manufacturing; and Cliff Gardner, who continues as chief product engineer.

Ralph W. Kane, formerly manager, instrument division, has been elected vice-president in charge of the instrument division. Lloyd Sorg has been appointed manager of plant engineering and facilities.



John P. Hagen

Through Electronics" as its theme.

Principal addresses will be given by Dr. John P. Hagen, director of the "Vanguard" project at the Naval Research Laboratory, Washington; Dr. Frederick L. Hovde, president of Purdue University, Lafayette, Ind. and Dr. Herbert Scoville Jr., assistant director of the U.S. Central Intelligence Agency, Washington.

The NEC is sponsored annually by the IRE, AIEE, Illinois Institute of Technology, University of

keeping  
an idea  
**locked**  
between  
your ears?

If that idea deals with the Guided Missile field, you'll find that Firestone has the key to unlock it—and open the door to a happier future for you. Firestone's creative climate and tangible rewards keep that door open to a steady flow of achievement.

Since the turn of the century, Firestone has built its phenomenal progress on men with ideas. Currently, Firestone is carrying forward the Army's vital program for the "Corporal," first surface-to-surface ballistic guided missile. This involves engineering, field test and service, and missile and component development.

But we need more men to fill more key spots than we can list here:

*Electronic Systems*  
*Propulsion Components*  
*Flight Simulation*  
*Mechanical Structures*  
*and Dynamics*  
*Field Engineering*

Let's get together to make the most of that idea... and your future. Write us today!

**Firestone**

**GUIDED MISSILE DIVISION**

RESEARCH • DEVELOPMENT • MANUFACTURE

*"Find your Future at Firestone"—Los Angeles • Monterey*

WRITE: SCIENTIFIC STAFF DIRECTOR, LOS ANGELES 54, CALIF.

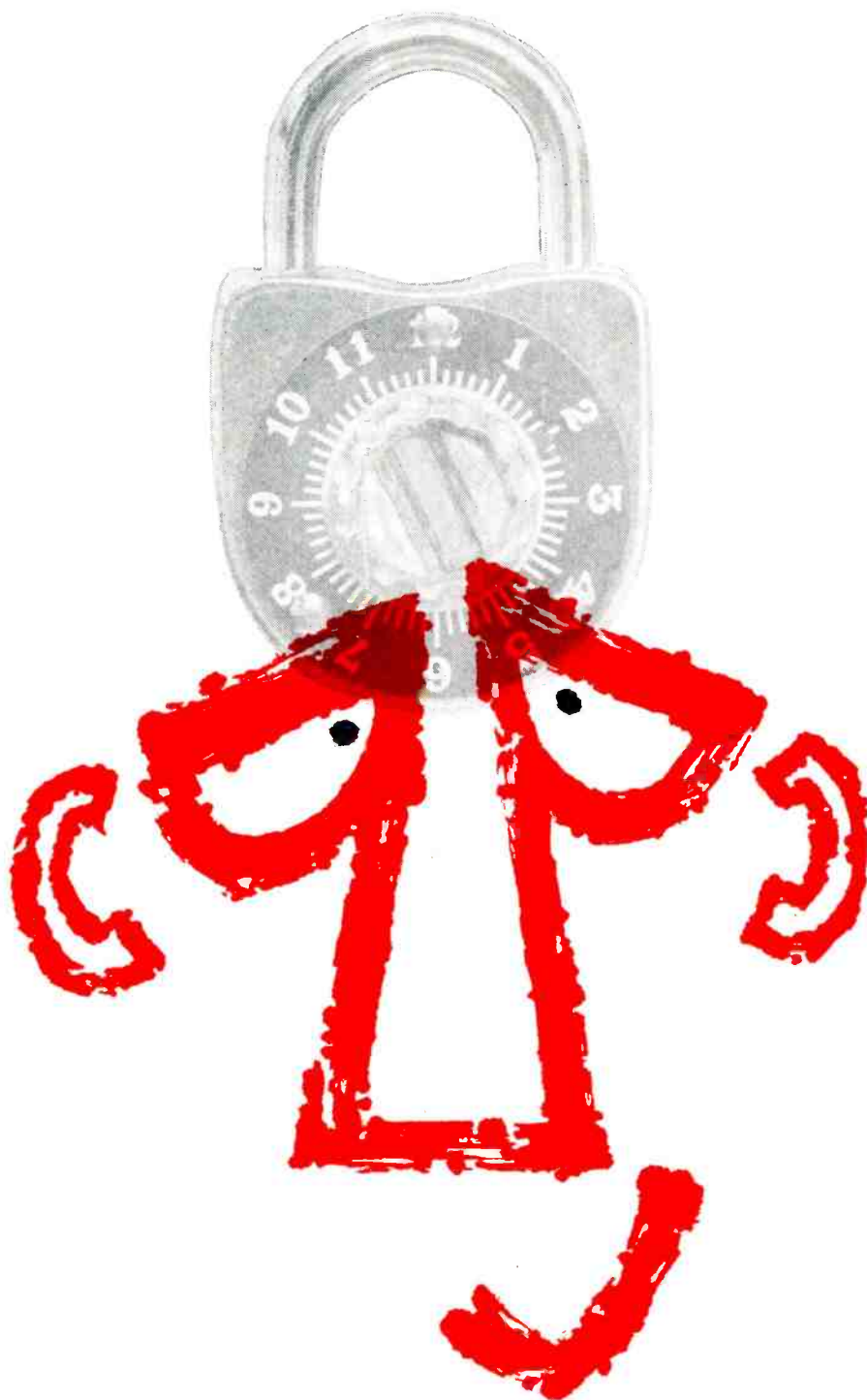



## Centrifugal Blowers

quickly dissipate heat from tubes, circuit components, other enclosed equipment

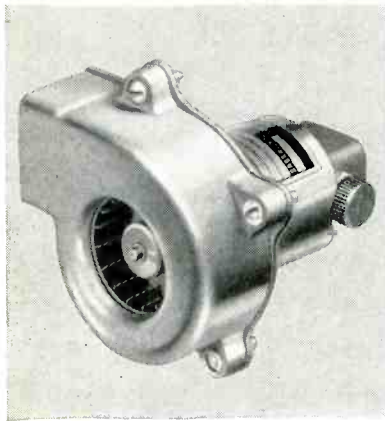

powered with Barber-Colman permanent magnet d-c motors

Having heat problems with electron tubes and other circuitry equipment mounted in confined enclosures? Install Barber-Colman permanent magnet centrifugal blowers for quick, dependable heat dissipation. Air volume for a typical unit is 20 cfm at 0 static pressure and 70° F. Voltages range from 6 to 115 volts d-c. Units available for either clockwise or counter-clockwise rotation . . . several sizes, various mountings. Send for free technical bulletin.

The complete line of Barber-Colman d-c motors



. . . includes both permanent magnet and split series types . . . in various mountings and speeds with outputs up to 1/10 hp. Ideally suited to power electro-mechanical actuators, switches, and programming devices. Also available with gearheads or blowers for special applications. Whatever your problem involving small d-c motors, let Barber-Colman Company engineers help you find the solution. Write for free Catalog F-4344-3.

**Barber-Colman Company**

Dept. J, 1459 Rock Street, Rockford, Illinois  
Want more information? Use post card on last page.

Illinois and Northwestern University.

Also participating in the conference are Michigan State, Purdue, Michigan and Wisconsin universities, as well as RETMA and SMPTE.

► **Program**—The opening day's technical sessions will concern components and materials, instrumentation, measurements, receiver techniques, data storage systems, servomechanism theory and applications.

On Oct. 2, the technical program will deal with information theory applications, magnetic amplifiers, solid state devices and applications, network and filter theory, data processing systems, microwaves, and radio isotopes.

The conference will conclude on Oct. 3 with sessions relating to solid state, high power audio systems, network synthesis, antennas, quality control and reliability, automation techniques, medical electronics and pulse techniques.

The Midwestern Simulation Council will hold a concurrent session on "Simulation of Hydraulic Systems" on the afternoon of Oct. 3 for those specializing in this field.

A record 240 commercial exhibits also will be displayed at the conference, 54 more than the previous high set last year.

### Litton Plans To Acquire Triad

LITTON INDUSTRIES plans to purchase Triad Transformer Corp.

Triad and its Indiana subsidiary, Utrad Corp., would be the ninth facility operated by Litton. Triad makes electronic transformers, reactors, toroid coils, electronic wave filters and related products.

### Stromberg Selects Chief Engineer

RUDOLPH G. MILLER has been appointed chief engineer of the special products division of Stromberg-Carlson.

He succeeds Frank H. Slaymaker, who recently was named manager of electroacoustical research.

Miller first joined Stromberg-

## Have you received your copy?

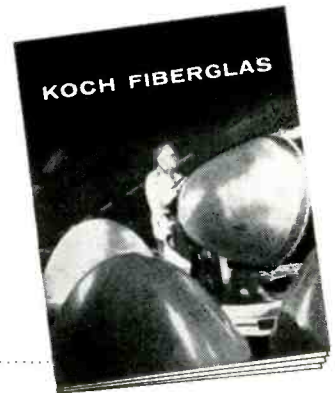

VALUABLE NEW  
TECHNICAL DATA  
DESIGN IDEAS  
MATERIEL INFORMATION

Send for

"Introduction to  
Fiberglas Fabrication"  
by

**KOCH FIBERGLAS**

**FREE!**

**TENTH ANNIVERSARY 20-PAGE  
ILLUSTRATED MANUAL**

**Every day, Koch Fiberglas is  
filling new uses in your industry**

Koch cases for electronic equipment will not dent, are impervious to moisture, vapor, fungus, mildew and corrosion. They are shock and vibration-proof when fitted to Koch specifications with special hair-latex shock pads. Can be self-palletized for fork lift. Can be insulated by Koch with foamed-in-place plastic. Koch cases are air-tight; require no paint or outer packaging for long-range storage or overseas shipment. Re-usable, so cost amortizes through re-use. Withstand parachute drops from any height, free falls onto water or snow from 500 feet, or submersion.

For manual, write on your business letterhead to Dept. EBD.

**KOCH**  
PRONOUNCED "KOKÉ"  
**FIBERGLAS**

CORTE MADERA, CALIFORNIA

One of the world's largest fabricators of molded Fiberglas products  
Want more information? Use post card on last page.

Carlson in 1926 as a radio design engineer, and worked in that capacity until 1929. He returned to Stromberg-Carlson in 1940 as engineer in charge of the special products laboratory and subsequently became assistant chief engineer of the radio-television division.

### Beckman Opens Plant, Expands In Germany



New Beckman Berkeley division plant

BERKELEY division of Beckman Instruments has completed a \$500,000 building program initiated last year to more than double the size of the Richmond, Calif. facilities. The division makes electronic counting and computing equipment.

Remodeling of the existing plant plus a new, 55,000 sq ft building provide 100,000 sq ft of working space for 550 engineering, production and office employees.

In addition, the plant houses an analog computer rental center, with a 100 amplifier computer available to solve problems on a leased-time basis.

► **Abroad**—Beckman plans to expand its German subsidiary in Munich, Beckman Instruments GmbH., which was founded about three years ago.

A new manufacturing plant and an office building for the production of instruments, ultra-centrifuges and computers is to be constructed. Total construction cost is about \$590,000.

Some 500 workers and employees will work in the new plant buildings but provisions are made to

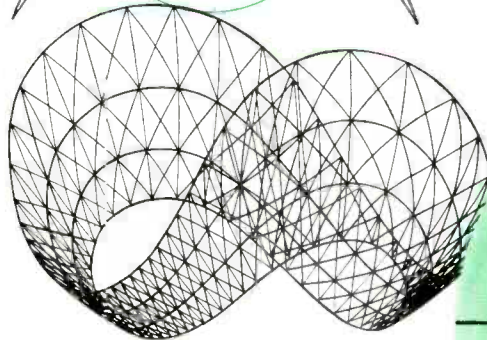
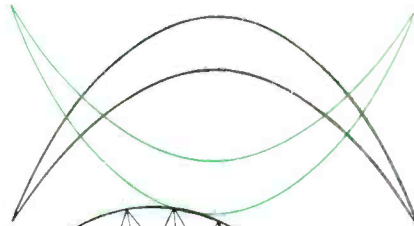
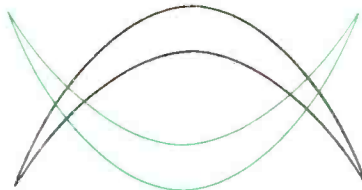
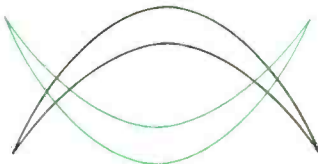
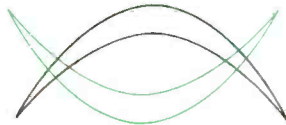
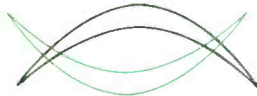
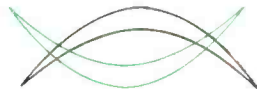

## ... ROUND TRIP TICKET

You can obtain the obvious advantages of a round trip ticket by bringing your radar component problems to Microwave Associates. We are equally concerned with both legs of the radar journey. Our products will not only help insure maximum transmission of energy to the target but will contribute to most efficient conversion of available return signals into useful data.

Microwave Associates offers the following design improvements to increase radar efficiency, sensitivity and reliability:

*New, higher power designs, decreased spike leakage and insertion loss, faster recovery time and longer life.*

**SILICON DIODES**

*Long life Philips cathode, high altitude designs, extra rugged construction for operation under extremes of shock and vibration.*

**TR DUPLEXER TUBES**

*Recently developed super sensitive E Mixer series offers increased burn out resistance for longer life.*

**MAGNETRONS**

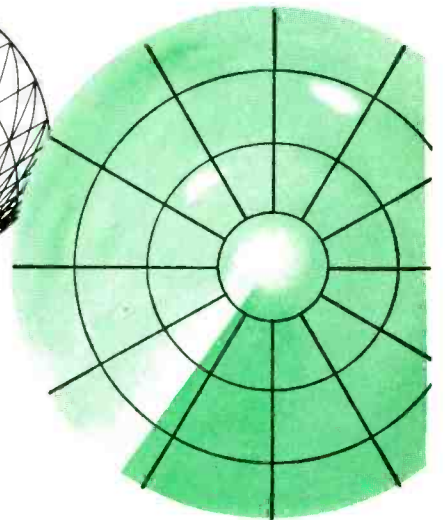

**MICROWAVE ASSOCIATES INC.**

22 Cummington St., Boston 15, Mass. CO pley 7-7577

Soon at our new plant: Northwest Industrial Park, Burlington, Mass.

...and it's  
extra-sensitive to



# Red!

New! Low-cost G-E cadmium selenide photoconductive cell offers you:

- **Wide range** — Responds to most visible light sources. *Excellent response in near infrared*—peaks at 7600 Angstrom units.
- **Long life** — HERMETICALLY SEALED IN GLASS. Excellent resistance to shock and vibration.
- **5 Sensitivity Ranges**—From 1 to 300 microamps at 100 v, 1 ft-candle to meet your design requirements.
- **High-speed response** — 10 to 60 milliseconds at 1 ft-candle.
- **Simplified circuitry** — Fewer tubes — 100 to 300-volt operating range.

For complete technical data, write X-Ray Department, General Electric Company, Milwaukee 1, Wisconsin. Ask for Pub. BY-104.

*Progress Is Our Most Important Product*

**GENERAL  ELECTRIC**

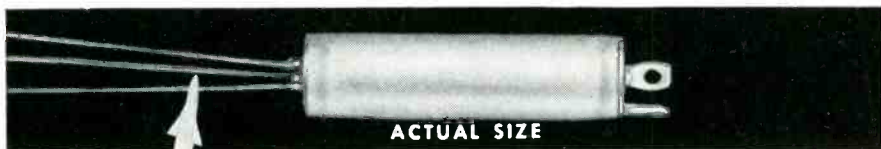

ACTUAL SIZE

## A RELAY that flies with NIKE

### 15 G UP TO 2000 CPS

Limited quantity of model shop samples available. Submit your specifications and requirements with your inquiry.

#### DIMENSIONS

15/32" dia. x 1-3/4" long

#### WEIGHT

7/8 oz.

#### OPERATING POWER

500 MW Max. (This relay is available for power requirements as low as 100 MW but with slightly less vibration resistance.)

#### VIBRATION RESISTANCE

15G up to 2000 CPS

Photo  
Nike installations,  
courtesy Western  
Electric Company

# Wheelock SIGNALS INC.

RELAYS



LONG BRANCH, N. J.

later expand the plant facilities for 1,000 workers.

Arnold O. Beckman, president of Beckman Instruments, has been elected to the board of directors of Marchant Calculators of Oakland, Calif. Dr. Beckman is to serve on the Marchant board's executive committee, also.

## Westinghouse Air Brake Elects President

A. KING MCCORD has been elected president of Westinghouse Air Brake.

He succeeds E. O. Boshell who has been serving as both chairman of the board and president since joining Westinghouse Air Brake in 1951. He will remain chairman of the board.

McCord has been president since 1950 of the Oliver Corp., producer of agricultural and construction equipment. He started with the company as an attorney in 1930.

## Carrier Organizes Research Company

COLORADO RESEARCH CORP., with headquarters at Denver, has been organized by Carrier Corp., air conditioning firm.

The new firm will work on electronic and applied physics. Special work on air conditioning will also be done for Carrier.

Present facilities in Denver will be replaced with expanded quarters later.

The new research organization is headed by Richard C. Webb as president and William R. Jewell as vice-president. Both were formerly with the Denver Research Institute of the University of Denver.

## RCA Selects Four Engineers

ANTHONY L. CONRAD has been elected vice-president, missile test project, RCA Service Company.

He has been manager of RCA's missile test project, government service department at Patrick Air Force Base, Florida, since its establishment in 1953. He joined the company in 1946. RCA operates



the electronics portion of the Air Force Guided Missile Test Range.

As manager of the missile test project, Conrad has directed the installation, operation and maintenance of electronic and optical instrumentation at the Patrick Base and at the down-range islands in the Atlantic Ocean.

RCA also announced the appointment of John M. Spooner as manager of the Findlay, Ohio, plant which manufactures transformers and deflection yokes. Previously he was manager of the kinescope servicing plant at Sellersville, Pa. He joined RCA in 1936.

Alvin B. Pollock has been named manager of the Bloomington, Indiana, tv plant of RCA Victor.

He succeeds George L. Leinenweber, who becomes general manager of the television division of RCA Victor in Canada.

Leinenweber joined RCA as an accountant in 1942. Pollock first came to RCA in 1941 and rejoined the company in 1946.

### Firestone Names Chief Engineer



Daniel T. Sigley

DANIEL T. SIGLEY has been appointed chief engineer for the guided missile division of the Firestone Tire & Rubber Co. of Calif.

He was formerly chairman of the guided missile steering committee and associate director of the general engineering laboratories for the American Machine & Foundry Co. in Greenwich, Conn.

Dr. Sigley replaces Capt. Frank MacDonald, USN, ret., who has been named director of the firm's



**PRECISION REGULATED**

- ✓ **STABILITY**  
(Long term  $\pm 100$  ppm — Short term  $\pm 50$  ppm per hour)
- ✓ **LOW RIPPLE**
- ✓ **LOW IMPEDANCE**

Here's a voltage reference that can be depended upon for many laboratory functions, but specifically suited for calibrating meters, powering multi-stage amplifiers and computers.

**OUTPUT TOLERANCE** for 10% line voltage variation:  $\pm .05\%$  or less.  
**VOLTAGE RELIABILITY** read on decade dials: .02% or 5 millivolts, whichever is greater.  
**OUTPUT VOLTAGES:** (1) 10 to 310 volts in 1 volt steps @ 150 ma. max. (2) 0-150 volts continuously variable @ 5 ma. max. (3) 6.3 volts unregulated @ 3 amperes CT.

*Oregon Electronics*  
Model PR 300



**CLOSELY REGULATED**

- ✓ **Low Voltage—High Current**
- ✓ **DC POWER SUPPLY**

A Magnetic Amplifier Power Supply with output at 15 amperes continuously variable from 5 to 32 volts without switching.

**REGULATION**  $\pm 1\%$  from no load to full load,  $\pm 1\%$  from 105 to 125 volts input.  
**RIPPLE VOLTAGE:** 1% RMS @ 32 volts and full load, increasing to 2% @ 5 volts or full load.

Complete specifications and details upon request—write or wire today

*Oregon Electronics*  
Model 32V15A

**Oregon Electronics** 2232 EAST BURNSIDE STREET  
 PORTLAND 15, OREGON  
 BElmont 6-9292  
**MANUFACTURERS OF SPECIAL ELECTRONIC EQUIPMENT**

*designed for continuous duty.*

### 360-440 CPS BENCH TYPE

#### Variable Frequency Power Supply

Operating from standard 115v 60 cps power, the Model 1460 provides 400 cps 100-130 volt supply at any bench position. Utilization of units of this type allows testing at 400 cps - 10% at any individual position without interference with any other test position. The unit can be easily operated by unskilled personnel.

Catalog "M" describing this unit as well as other CML generators in the power range of from 50 VA to 80 KVA in single and three phase units and frequency range of 20 cps to 60 KC with all specifications listed, is yours on request.

Our design engineering department is at your service to design and custom-build a power supply unit for your specific need.

**WHERE  
DEPENDABILITY  
IS OF  
PRIME  
CONCERN**



**OUTPUT - 100 V. A.  
DISTORTION - 2%  
STABILITY - 1 CPS  
REGULATION - 1%**



**COMMUNICATION MEASUREMENTS LABORATORY, INC.**

350 LELAND AVENUE, PLAINFIELD, NEW JERSEY

# DEFLECTION YOKES

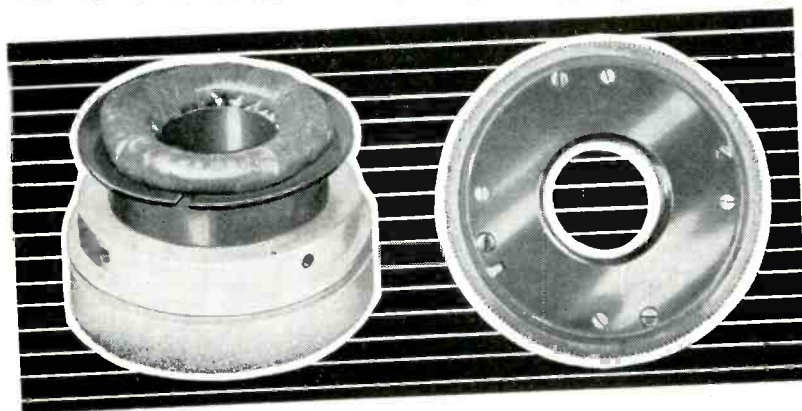

We specialize in the design and manufacture of precision deflection yokes for military and commercial applications. Phone or write for immediate engineering evaluation of your critical display problems.

## Celco

Phone: RAmsEY 9-1123

*Constantine Engineering Laboratories Co.*

Island Avenue

Mahwah, N. J.

newly-established engineering laboratory at Monterey, Calif.

At Firestone, Sigley will direct the company's engineering, both electronic and mechanical, on advanced weapon systems, such as the Army's Corporal.

As a member of the principal professional staff and chairman of the planning board at the Applied Physics Laboratory, Johns Hopkins University, he was responsible for the guidance portion of the Navy's Bureau of Ordnance missile programs which included the technical development of the Bumblebee, Terrier and Talos missiles.

## Huggins Expands For Traveling-Wave Tubes

HUGGINS LABORATORIES, producer of traveling-wave tubes, is completing construction of a plant addition in the San Francisco area which will double previous working space and bring total area to 16,000 sq ft. The plant will be devoted to both the production and development of traveling-wave tubes. In its expanded form, the building will accommodate approximately 100 employees. The building program represents the fourth time the plant has been doubled since 1952.

## Norden-Ketay Builds Plant

THE NORDEN-KETAY CORP. has constructed additional office and production facilities on 20,000 sq ft of land in Gardena, Calif. This brings the total manufacturing and laboratory space to 50,000 sq ft.

The new area will be used for the manufacture of aircraft-type synchros and resolvers. Harry Loveman, operations manager, has been named to head the instrumentation group.

## Burroughs Forms Tube Division

BURROUGHS CORPORATION has formed a new electronic tube division in Plainfield, N. J. and appointed Saul Kuchinsky as the division's general manager.

The new division will occupy the

Plainfield plant of Haydu Brothers of New Jersey, formerly a Burroughs subsidiary. It will be responsible for the manufacture and sale of special vacuum tubes and other electronic components.

Kuchinsky, previously in charge of tube research and development at Burroughs research center, has been for the last year manager of the applications engineering department of the former Plainfield subsidiary.

### Sperry Rand Builds For Aviation Electronics

SPERRY RAND has acquired a 480-acre plant site, near Phoenix, Ariz., and plans the immediate construction there of an aviation electronics plant.

Construction of an initial plant unit, between 75,000 and 100,000 sq ft in area, begins in September. Manufacturing operations are to commence next Spring.

The company also plans construction later of a companion flight research unit at Phoenix's Sky Harbor Airport.

The initial Arizona plant unit will represent an investment by the company of more than \$2.5 million.

Sperry Rand will utilize the manufacturing facility for the development and production of electronic flight and engine control systems for advanced aircraft. About 500 people will be needed initially.

### GE Adds New Operation, Names Three

THE defense electronics division of GE has organized a new technical military planning operation, TEMPO, with responsibility for preliminary planning of future complex weapons systems. An organization of about 50 employees is planned with headquarters in California. Richard C. Raymond has been appointed manager of the new unit. He comes to GE from the Rand Corp. of Santa Monica, Calif., where he was head of the electronics department. The division also announced that the advanced electronics center at Cornell University, Ithaca, N. Y., will become a part of the company's light mili-

SEE GRC AT THE  
NAT'L METAL SHOW  
Booth # 550  
On the stage



## if you use small gears & pinions

**IT WILL PAY YOU TO CHECK**

### GRC'S STOCK SHEET

Before you order gears or pinions, see GRC's new Stock Sheet. All items listed are cast from stock dies, individually or in various combinations of gears, pinions, hubs, shafts, etc. Holes, shafts spacers, shoulders, etc., are made to your exact specifications at no extra tool charge, quantity permitting. Maximum O.D. about 1 1/2", with 1/16" face width; wider faces for smaller diameters. • Unusual shapes, extra precise requirements, available on special order.

**WRITE TODAY for new stock sheet and samples.  
SEND SPECIFICATIONS FOR PROMPT  
QUOTATION — 100,000 TO MILLIONS**



**GRIES REPRODUCER CORP.**  
World's Foremost Producer of Small Diecastings  
151 Beechwood Ave., New Rochelle, N. Y. • Phone NEw Rochelle 3-8600

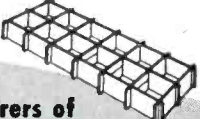

**For manufacturers of  
Radio, Electrical and Electronic  
components and allied products!**

Pre-assembled...custom-made

## PARTITIONS

**for Protective  
Packaging  
made to your exact  
specifications  
for faster packing  
at lower cost!**



**WRITE, PHONE or WIRE  
for QUOTATIONS on  
YOUR REQUIREMENTS**

**PETER PARTITION CORP.**  
operates one of the largest  
plants in America devoted  
exclusively to the produc-  
tion of cardboard partitions.  
Because of our unexcelled  
facilities, our customers  
know we are equipped to  
fill orders **FAST, ON TIME,**  
and **AS SPECIFIED—at a  
price that's always right!**

## PETER PARTITION CORP.

Manufacturers of Cardboard Partitions

**124 BOERUM PLACE      BROOKLYN 1, N.Y.**

Telephone: TRIangle 5-4033

## "OUR HF THERMATOOL Method WELDS TUBING FASTER AND BETTER WITH THE HELP OF MAGNATRAN TRANSFORMERS"

says *W. C. Rudd, Vice President*  
New Rochelle Tool Corporation.

Using a patent pending method this company relies on the dependability of Magnatran transformers in their equipment. They specialize in HF equipment for either induction or dielectric heating.

Magnatran Magnetic Components are used throughout the electronic industry. Proven performance and quality is yours with Magnatran.

Whether you require conventional equipment or specially engineered products, choose and use Magnatran. Be modern and secure. All Magnatran components meet or exceed the standards of AIEE, ASA, NEMA and RETMA.

Write for BULLETINS.

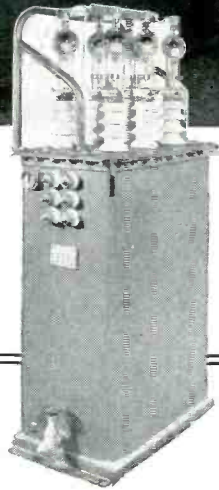
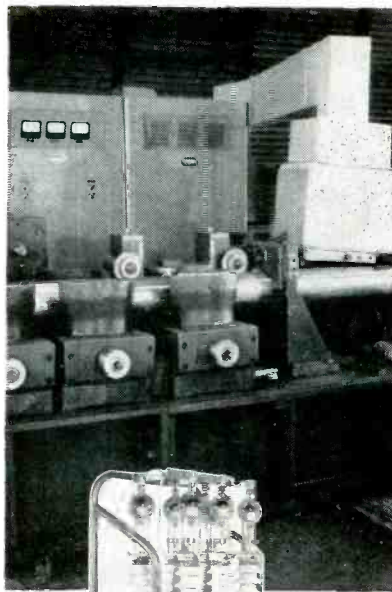

**MAGNATRAN** incorporated

P.O. Box 211 KEARNY, NEW JERSEY, U.S.A.

for service and lab. work

### Heathkit PRINTED CIRCUIT OSCILLOSCOPE KIT FOR COLOR TV!

① Check the outstanding engineering design of this modern *printed circuit* Scope. Designed for color TV work, ideal for critical Laboratory applications. Frequency response essentially flat from 5 cycles to 5 Mc down only 1½ db at 3.58 Mc (TV color burst sync frequency). Down only 5 db at 5 Mc. New sweep generator 20-500,000 cycles, 5 times the range usually offered. Will sync wave form display up to 5 Mc and better. Printed circuit boards stabilize performance specifications and cut assembly time in half. Formerly available only in costly Lab type Scope. Features horizontal trace expansion for observation of pulse detail — retrace blanking amplifier — voltage regulated power supply — 3 step frequency compensated vertical input — low capacity nylon bushings on panel terminals — plus a host of other fine features. Combines peak performance and fine engineering features with low kit cost!

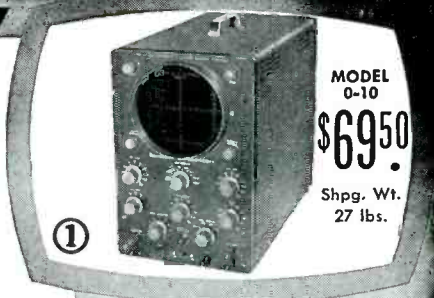

MODEL  
0-10  
**\$695.00**  
Shpg. Wt.  
27 lbs.



MODEL  
TS-4  
**\$495.00**  
Shpg. Wt.  
16 lbs.

### Heathkit TV SWEEP GENERATOR KIT ELECTRONIC SWEEP SYSTEM

② A new Heathkit sweep generator covering all frequencies encountered in TV service work (color or monochrome). FM frequencies too! 4 Mc — 220 Mc on fundamentals, harmonics up to 880 Mc. Smoothly controllable all-electronic sweep system. Nothing mechanical to vibrate or wear out. Crystal controlled 4.5 Mc fixed marker and separate variable marker 19-60 Mc on fundamentals and 57-180 Mc on calibrated harmonics. Plug-in crystal included. Blanking and phasing controls — automatic constant amplitude output circuit — efficient attenuation — maximum RF output well over .1 volt — vastly improved linearity. Easily your best buy in sweep generators.

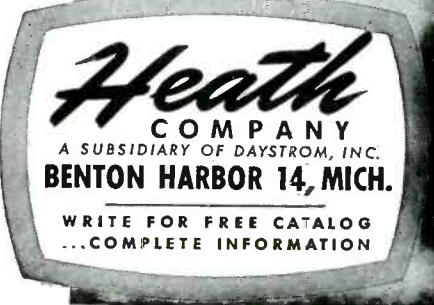

**Heath**  
COMPANY  
A SUBSIDIARY OF DAYSTROM, INC.  
BENTON HARBOR 14, MICH.

WRITE FOR FREE CATALOG  
...COMPLETE INFORMATION



O. H. Winn

tary electronic equipment department at Utica, N. Y.

It was formerly a part of the defense division's laboratories operation.

The move is an organizational one designed to provide the department with additional facilities for applied research and advanced development. No move of the AEC facility from Ithaca is planned.

The laboratory employs 275 people, including about 150 scientists and engineers, working on military projects involving air defense, air-surface warfare, countermeasures, communications, navigation, detection and automation.

O. H. Winn has been named manager of the Cornell center, succeeding Walter Hausz who is now on assignment with a special study group for the Secretary of Defense.

Winn has been manager of fire control radar and countermeasures systems engineering for the LMEE department since 1951.

GE also announced that Robert R. Johnson has been named manager of digital-computer-engineering for the industrial computer section in Syracuse, N. Y. He has been doing engineering development work for the industrial computer section's ERMA computer project in Menlo Park, Calif.

### Stewart-Warner Buys Cardwell

STEWART-WARNER'S ELECTRONICS division has entered the facsimile transmission and reception equipment field, with purchase of the entire facsimile business of The Allen D. Cardwell Electronics Pro-

ductions Corp. of Plainville, Conn. Stewart-Warner electronics plans to expand the development and production of facsimile apparatus for both commercial and military applications. Planned development includes press association use of facsimile for picture transmission and reception as well as intercity and interplant use of facsimile both by industrial, commercial and government agencies.

### Ferrite Testing Group Formed

AT THE ANNUAL MEETING OF THE AMERICAN CERAMIC SOCIETY, a group was formed under the ASTM C-21 committee to set up specifications for the testing of ferrites. About twelve companies were represented.

Other companies interested in ferrites testing are invited to contact Dr. S. Blum, Research Division, Raytheon Manufacturing Co., Waltham, Mass. A group meeting is scheduled for October 15, 1956 at M.I.T. to discuss future activities.

### Bendix Names West Coast Engineer



Ralph A. Lamm

RALPH A. LAMM has been appointed director of engineering for the pacific division of Bendix Aviation Corp. He was head of special missile development at the Bendix research laboratories division. He joined the corporation staff in 1955.

Prior to World War II, he was

# Teflon...\*

## Your Best Source Is

### JOHN CRANE

Thickness Inches	Nominal Size
1/16	12 x 12
3/32	18 x 18
1/8	24 x 24
3/16	36 x 36*
1/4	48 x 48*
3/8	
1/2 & Up	

\* Can be furnished in 1/2 sheets



### SHEET

**HERE'S WHY:** You can order in quantity and in a wide variety of sizes—and be certain of complete uniformity throughout. Our strict density control assures you thoroughly non-porous Teflon—free from any flaws which might possibly affect your end use or product. Dimensions are accurate to your most critical tolerances—no rejects, waste of material or loss of time. You get product purity—Teflon at its best in every one of its remarkable characteristics. Delivery is prompt—you get the quantity you want when you want it.

Since the availability of Teflon, "John Crane" engineers have worked with Industry to successfully solve innumerable problems and develop new applications. *You can benefit from their experience and know-how.*

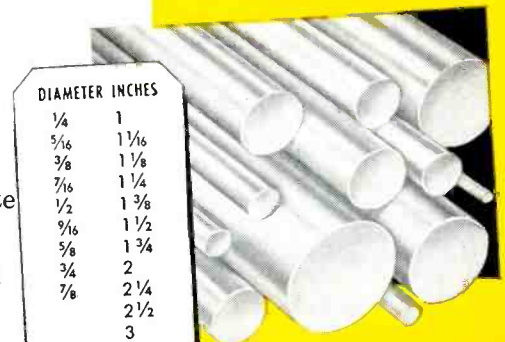

DIAMETER INCHES	
1/4	1
3/16	1 1/16
3/8	1 1/8
7/16	1 1/4
1/2	1 3/8
5/8	1 1/2
3/4	1 3/4
7/8	2
	2 1/4
	2 1/2
	3

Other diameters on specification

### ROD



TYPICAL SIZES INCHES	
O. D.	I. D.
3/8	1/4
1/2	3/8
3/4	1/2
1	3/4
1 1/2	1
2 1/2	1 1/2
3	1 3/4

### TUBING

#### Characteristics of Teflon

- CHEMICAL**  
Completely inert.
- ELECTRICAL**  
Very high dielectric strength.  
Extremely low power factor.
- THERMAL**  
Temperature range  
-300° to +500° F.
- MECHANICAL**  
Strong, flexible, weather resistant.
- LOW COEFFICIENT OF FRICTION**  
Absolutely non-stick.

\* DuPont Trademark

Request full information and ask for our bulletin, **The Best in Teflon.** Crane Packing Co., 6402 Oakton St., Morton Grove, Ill., (Chicago Suburb)

In Canada: Crane Packing Co., Ltd., Hamilton, Ont.



## CRANE PACKING COMPANY



## POTTING AND ENCAPSULATION IN RESINS FOR PROTECTION PLUS IN COILS AND TRANSFORMERS

Protection is Potting and Encapsulation for longer life and better performance under adverse conditions such as moisture, vibration, heat. The Plus is NYCO's 53 years of experience in custom manufacturing.

For specification-correct transformers, reactors, chokes, capacitors, coil windings, assembly with or without parts fabrication, contact NYCO . . . producer since 1903 of electrical and electronic parts.

Send your specifications now for quotation. Address New York Coil Company, Phoenixville 10, Pennsylvania.

# nyco

AS OLD AS THE INDUSTRY

### have you Edge Lighting Problems?

The unparalleled design flexibility of the Lackon® photo-marking process may offer you the best solution. With a minimum of gimmicks and gadgetry, Lackon® gives you a panel of unequalled marking accuracy, optimum legibility and lighting uniformity, with excellent resistance to severe environmental conditions. Designed, tested and quality controlled in our government approved laboratory, Lackon® edge lighted panels, knobs and knob skirts meet and exceed lighting, legibility and durability requirements of specification MIL-P-7788.



The Lackon® engineering staff of the United States Radium Corporation will readily assist your panel engineering department during the initial design stage. The cooperative application of their skill and experience in lighting techniques will speedily resolve design difficulties, result in decided production economies, and yield a remarkably superior finished product. For information write Dept. E-10

**United States  
Radium Corporation**

Hanover Ave., Morristown, N. J.

Regional Offices: 5420 Vineland Ave., N. Hollywood, Calif.; 4624 W. Washington Blvd., Chicago, Ill. Affiliates: In Canada — Radelin-Kirk Ltd., 1168 Bay St., Toronto, Ont.; In Europe — United States Radium Corp.—Europe, 36 Avenue Krieg, Geneva, Switzerland.

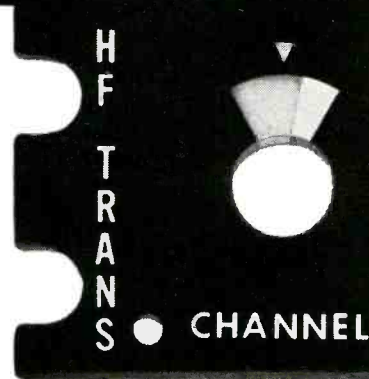

chief engineer for Troy Radio and Television, Los Angeles.

From 1941 to 1943, he was a staff member of the Radiation Laboratory of MIT.

In 1948, he became chief of the missiles division of the National Bureau of Standards in Washington, and in 1951 he came to California as assistant director and chief of the missile division of the newly-established Corona Laboratories of NBS. He became technical director in 1953.

## Daystrom Pacific Builds New Plant

GROUND breaking for Daystrom's new million-dollar Daystrom Pacific Corp. plant in Westchester, Calif. is scheduled for late September. The corporation, with its American Gyro division, will move into the new 50,000 sq ft office-research-manufacturing structure in February, 1957. Initially, the plant will have an employment capacity of 500 persons.

Daystrom Pacific, now located in Santa Monica, Calif., has two divisions—American Gyro with headquarters at Santa Monica and Daystrom Potentiometer in West Los Angeles. Total employment for the operations is 350 people.

The Daystrom systems division has been formed by Daystrom, Inc. It will design, build, test and install systems for automation applications. The new division will be located in LaJolla, Calif.

Chalmer E. Jones, formerly as-



Chalmer E. Jones

sistant to the president of Heath Co., another Daystrom unit, will be general manager of the systems division. He was formerly product line manager of the computer division of Beckman Instruments.

## Ramo-Wooldridge Expands, Names Duke

CONSTRUCTION has started on a new production facility for The Ramo-Wooldridge Corp. The plant, which will be located on a 640-acre site near Englewood, Colo., will cover 140,000 sq ft and will be used to produce electronic systems. It will also house development and liaison facilities. The plant will be completed in mid-1957 and will employ about 1,300 people.

► **Promotion**—William M. Duke, former vice-president of the Cornell Aeronautical Research Laboratory, has been named program director for the "Titan" Intercontinental Ballistic Missile program at Ramo-Wooldridge.

A member of The Ramo-Wooldridge senior staff, he was affiliated with the Cornell Laboratory and its predecessor, the Curtiss-Wright Research Laboratory, from 1943 to 1956.

## Intelligent Machines Begins Construction

INTELLIGENT MACHINES RESEARCH CORP. of Arlington, Va., has begun construction of new office, research and production facilities in Fairfax County, Va. Situated on a three-acre tract, the new plant will provide 15,000 sq ft of floor space, about three times the area presently used. Occupancy is to begin in November.

## U. S. Industries Acquires Western Design

U. S. INDUSTRIES has acquired all the assets of Western Design & Manufacturing Corp.

Among the products presently being manufactured by Western are g-limiters, intervalometers and electronic power supply systems as well as motors and actuators.

U. S. Industries, under the

# Ask Yourself...

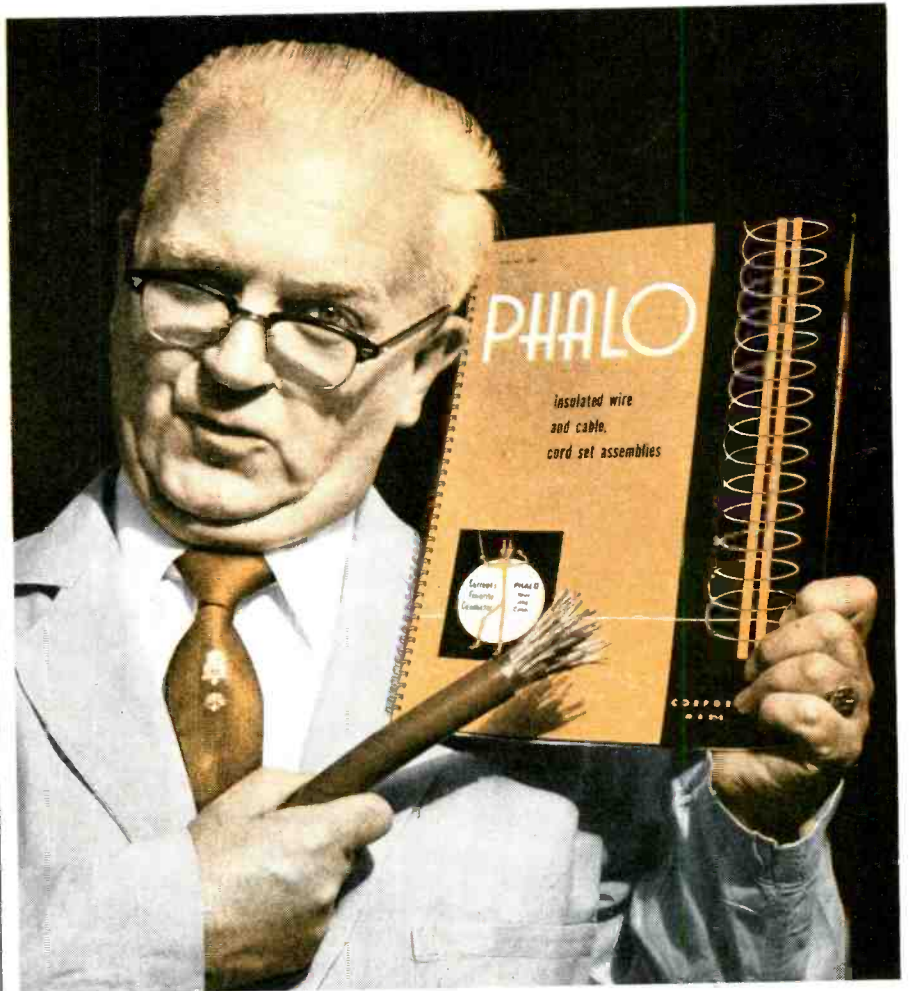

## Why Do More Of The Better Custom Cables Come From PHALO???

There has to be a reason — and there is! PHALO simply has more custom cable experience — more built-in custom cable ability — and the results prove it!

Phalo can show you a blue chip list of the firms who turn to them for the special cables.

— Same For Hook-Up Wire —

PHALO is the answer!

You'll get the quality you want, the specs you want, the delivery you want on Hook-Up Wire from PHALO!

Get this complete catalog — NOW!

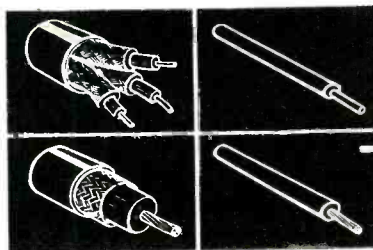

# PHALO

PLASTICS CORPORATION

*The Custom Insulation House*

CORNER COMMERCIAL STREET  
WORCESTER, MASS.

Insulated Wires, Cables — Cord Set Assemblies

# TRANSISTOR MAKING EQUIPMENT

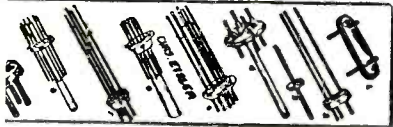

## DIODE MACHINERY AUTOMATIC OR SEMI-AUTOMATIC

FOR TRANSISTORS and DIODES  
8 STATION INDEXING 34 TURNING SPINDLES

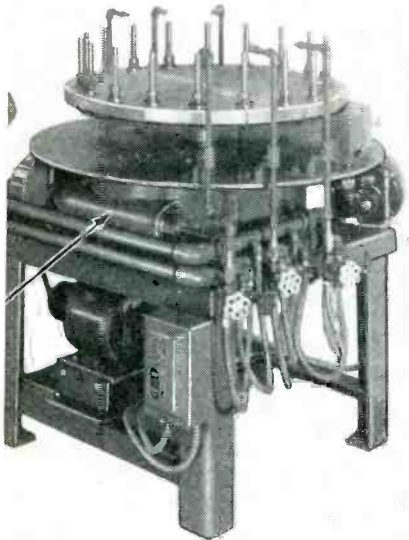
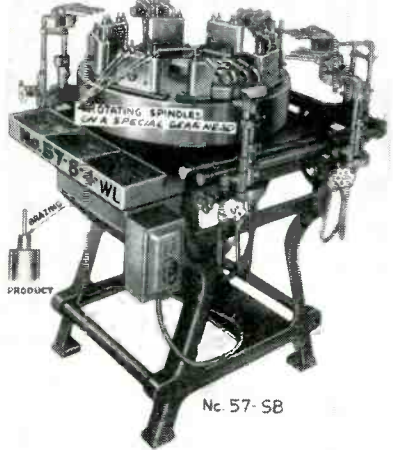

24 POSITION TRANSISTOR OR DIODE HEALER FULLY AUTOMATIC  
WIRE GLASS AND SHELL W/ HOPPER FEEDS

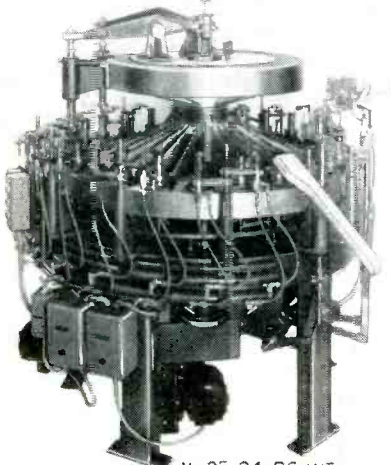

No. 23-24-BS WE

Send for Catalog Dr. Chas. Eisler, M.E. Founder  
CHAS. EISLER, JR., PRES.

**EISLER ENGINEERING CO., INC.**

751 So. 13th St. NEWARK 3, N. J.

Want more information? Use post card on last page.

### PLANTS AND PEOPLE

(continued)

leadership of John I. Snyder, Jr., is active in many fields, including oil field production equipment; water pumping, transmission and treatment equipment; and metal fabricating equipment.

U. S. Industries, whose sales amounted to \$81,279,343 and net earnings to \$3,606,221 in 1955, has 12 plants. The company employs over 6,000 persons and has over 10,000 stockholders.

## Continental Carbon Acquires Wirt

CONTINENTAL CARBON of Cleveland has acquired the Wirt Co. of Philadelphia.

Wirt manufactures electrical resistor type products and has operated continuously since 1910.

Production will continue on the firm's wire wound potentiometers, rheostats, tubular type wire wound fixed and adjustable resistors, flat type resistors, precision film type resistors and a line of slide switches.

## Davies Labs Appoints Engineering Chief



John M. Magida

JOHN M. MAGIDA has been appointed to the new post of director, systems and application engineering of Davies Laboratories. His new duties will center around the development and application of data recording equipment for air and ground instrumentation systems.

Magida previously served as

## Negative temperature and voltage coefficients

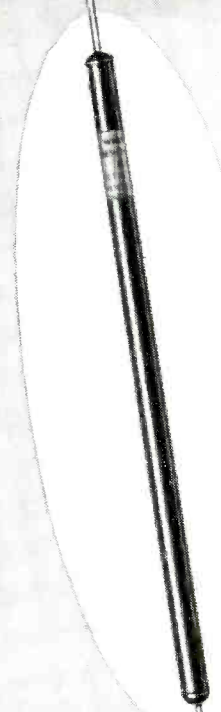

## S. White 80X MOLDED RESISTORS

**RATING**—3 watts—100 to 100,000 megohms

**SERVICE**—High voltage equipment such as electrostatic generators, atomic energy equipment, etc.

### CHARACTERISTICS

- Negative temperature coefficients
- Negative voltage coefficients
- Good stability, durability, mechanical strength
- Non-deterioration of values due to age
- Non-hygroscopic base specially processed against humidity
- Compactness

BULLETIN 4906 has full details. Send for a copy. Attention Dept. 9R.



THE **S. White INDUSTRIAL DIVISION**  
DENTAL MFG. CO.

10 East 40th St. New York 16, N. Y.

Western Office: 1839 West Pico Blvd., Los Angeles 6, Calif.

Want more information? Use post card on last page.

October, 1956 — ELECTRONICS



chief of the development and engineering section, for instrumentation at Air Force Flight Test Center, Edwards Air Force Base. There he headed the development of new instruments and instrumentation systems for flight testing aircraft and missiles.

During the Korean War he served as engineering officer for Airways and Air Communications Service, engineering the development and installation of navigational aids.

### Sorensen Merges With Beta Electric

SORENSON & COMPANY of Stamford, Conn., manufacturer of power supplies and line voltage regulators, has merged with the Beta Electric Corp. of New York, manufacturers of electronic instruments and meters.

The Sorensen firm, with a subsidiary in Zurich, is controlled and managed by Blanc and Marcel Corbat.

Beta Electric's president is Victor Wouk.

### Magnetic Tape Firm Formed

THE FERRODYNAMICS CORP. of Lodi, N. J. has been formed to manufacture magnetic recording tapes.

President of the new firm is Frederick I. Kantor and executive vice-president is O. Louis Seda.

### Ampex Promotes Three Engineers

WALTER T. SELSTED, director of research, has been elected an officer of Ampex Corp.

He organized the research department last year to carry out advanced study in many fields related to magnetic recording. He was formerly chief engineer of Ampex and is one of the four original engineers employed by the firm in 1949.

Before joining Ampex, Selsted was at the University of California Radiation Laboratory as a research engineer. He was also formerly chief engineer of the Pacific Broadcasting Co.

Robert Sackman has been elected

# NEW CASES • • NEW ADVANTAGES



## METALLIC CASES

- Tight-sealed with no rolled edges
- minimum axial case length for **MINIATURIZATION**
- surface insulated against voltage breakdown
- precision shaped for multiple stacking of cores



## PHENOLIC CASES

- Tight-sealed rigid core protection
- free from case to coil capacitance



## CERAMIC CASES

- Tight-sealed with maximum temperature endurance
- highest electrical insulation

Selection of suitable encasement will assure better uniformity of magnetic Centricore properties. Review of present core specifications to new case types should be made NOW. Write for data and prices.

**Centricores—Magnetic-engineered since 1930**

○ NO ROLLED EDGES

○ SURFACE INSULATED

○ TIGHT-SEALED



○ RIGID CORE PROTECTION

## MAGNETIC METALS COMPANY

ELECTROMAGNETIC CORES AND SHIELDS

HAYES AVENUE AT 21st STREET • CAMDEN 1, NEW JERSEY

# ANNOUNCING...

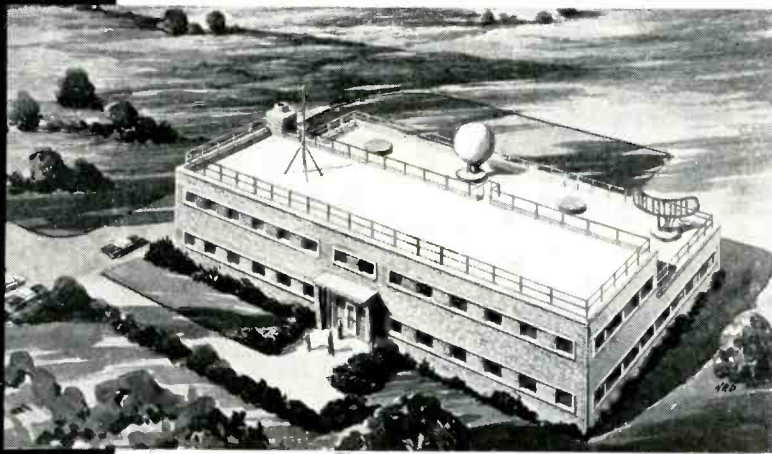

The microwave development facilities of Wheeler Laboratories are being augmented by an antenna range at Smithtown, Long Island. These new quarters, now under construction, will be equipped and staffed to solve unusual antenna problems.

*Inquiries are welcomed; a brochure describing our services is available.*

**WHEELER LABORATORIES, INC.**  
122 Cutter Mill Road • Great Neck, N. Y.

HUNter 2-7876



vice-president of Ampex Corp. He will continue as manager of the firm's instrumentation division, his position since 1954.

Sackman joined Ampex in 1953. Before that time he headed a Department of Defense research branch devoted to the development of recorders and data processing systems.

Russell J. Tinkham has been appointed manager of audio custom engineering for Ampex Corp. Tinkham has been with Ampex since 1952. He was formerly manager of the audio marketing department.

Before joining the firm, he was active in several areas of magnetic recording development and research. Until 1946, he was coordinator of magnetic research for the Armour Research Foundation of the Illinois Institute of Technology. He then became founder and president of Magnecord in Chicago, Illinois, which is engaged in the manufacture of magnetic tape recorders. Subsequently, in 1951, he became manager of the magnetic recording department for Shure Brothers in Chicago, Illinois.

## Eimac Names Tube Manager



Richard Chamberlin

RICHARD CHAMBERLIN has been named manager of the newly-created receiving tube department of Eitel-McCullough of San Bruno, Calif. manufacturer of Eimac electron power tubes. The department will handle production of the firm's new line of stacked ceramic receiving tube types.

Chamberlin, employed at Eitel-McCullough for the past 13 years, was formerly administrative as-

## STOCK KNOBS

IN ANY QUANTITY  
NEVER A MOLD CHARGE

GEE-LAR—The House of Knobs—can give you a wide selection of knobs for every application. Hundreds of patterns and styles always in stock, and you're never concerned with a tool charge.

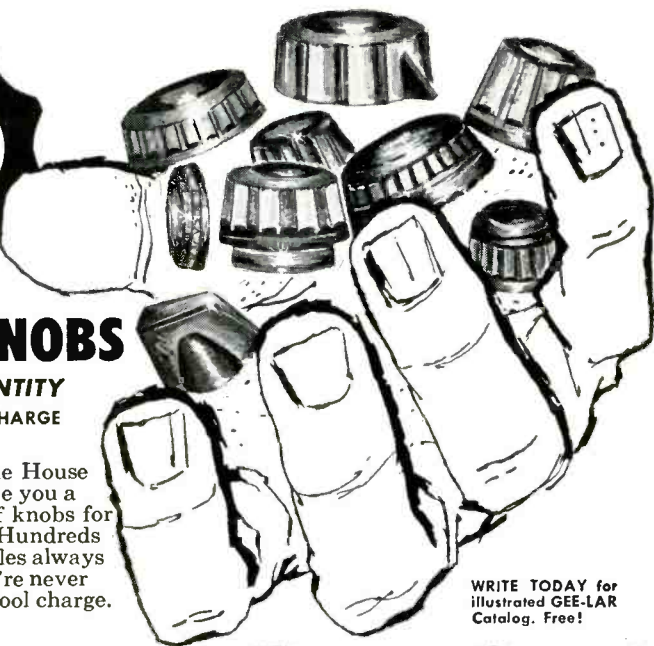

WRITE TODAY for illustrated GEE-LAR Catalog. Free!

### GOLD INLAY KNOBS

Select your knobs or pointers from GEE-LAR'S huge stock of quality products. Fast service... lower cost—always at GEE-LAR!



## GEE-LAR MANUFACTURING COMPANY

421 South Wyman Street • Rockford, Illinois

sistant to the manager of manufacturing. He will supervise pilot-plant production recently begun on the Eimac 33C3A2 twin-triode. Pilot-run production on this tube and other ceramic types already developed will involve only a few hundred tubes per week. However, Chamberlin will also be responsible for full-scale manufacturing operations using Eimac-developed automation equipment to meet a production target of 900 tubes per hour.

### Canadian Honeywell Elects President

W. H. EVANS has been elected president of Minneapolis-Honeywell Regulator Co. in Canada.

Evans, who has been general manager since 1941 and vice-president and general manager since 1951, takes over the presidency from Harold W. Sweatt who has been elected board chairman. He joined Honeywell as credit manager in 1931.

### Ruge Associates Appoints Koch

PAUL W. KOCH has been appointed executive vice-president and general manager of A. C. Ruge Associates of Cambridge, Mass. Koch was general manager of the Cambridge plant of the Baldwin-Lima-Hamilton Corp. Prior to that, he was general manager of Ruge-DeForest, of Cambridge and works manager of the Nordon Laboratories Corp. His experience in the instrumentation field includes 21 years with Bendix Aviation Corp. and Manning, Maxwell & Moore.

### Teleregister Selects Development Head

PHILLIP C. MICHEL has been appointed director of advanced development for The Teleregister Corp. of Stamford, Conn., a subsidiary of Ogden Corp. Dr. Michel will direct a group in the study of application of new techniques to the problems of electronic data handling systems.

From 1935 until 1949 he was a member of the advanced develop-

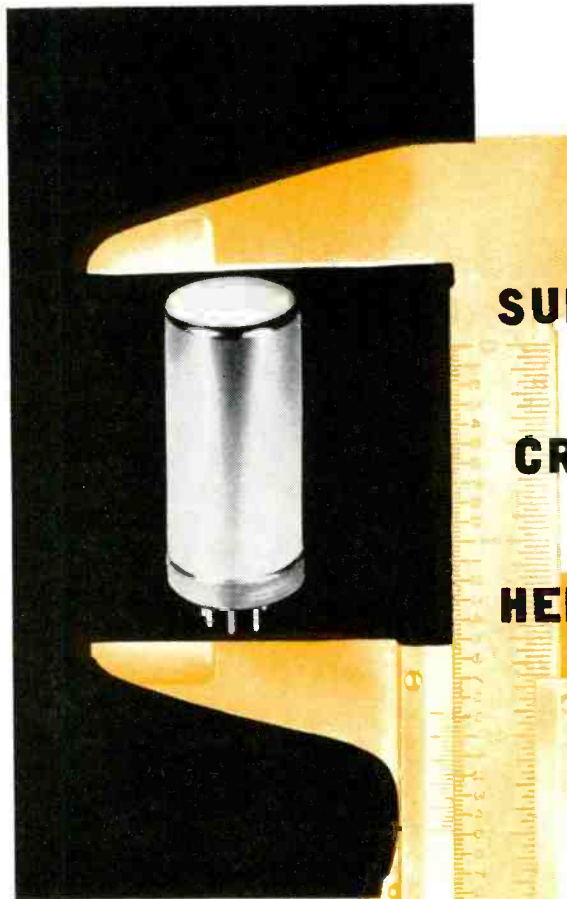

**BLILEY TYPE BTC-1**

SHOWN ACTUAL SIZE

This newest Bliley plug-in unit combines frequency control with integral temperature stabilization at 75° C. Specify BTC-1.

Frequency range: 5 mc to 125 mc.

Write for technical Bulletin #494.

Another achievement of Bliley craftsmanship!



**BLILEY ELECTRIC COMPANY**  
UNION STATION BUILDING • ERIE, PENNSYLVANIA

**NEW**  
**SUBMINIATURE PACKAGE**  
**CRYSTAL AND OVEN**  
**HERMETICALLY SEALED**

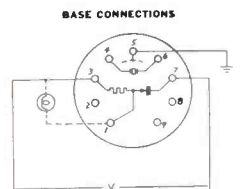
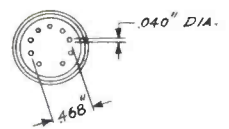
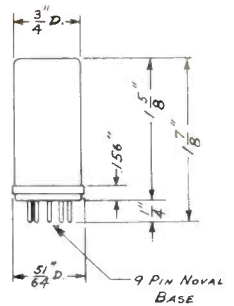

AMERICAN TELEVISION &  
RADIO CO. ST. PAUL, MINN.

introduces the  
**new**

**ATR TV**

*Full Door Console  
Receiving Sets*

UNSURPASSED  
IN BEAUTY

UNEQUALLED  
IN PERFORMANCE

UNMATCHED IN  
QUALITY  
CONSTRUCTION

exclusive  
profitable  
dealer  
franchises  
now available

*designed  
with the  
Serviceman  
in mind  
... easy to  
get at*



WRITE TODAY FOR COLORFUL  
BROCHURE SHOWING THE  
NEW LINE OF ATR TV SETS

ALSO MANUFACTURERS OF DC-AC INVERTERS,  
"A" BATTERY ELIMINATORS, AUTO RADIO VIBRATORS

**ATR** AMERICAN TELEVISION & RADIO CO.  
*Quality Products Since 1931*  
SAINT PAUL 1, MINNESOTA-U. S. A.

Want more information? Use post card on last page.

PLANTS AND PEOPLE

(continued)

ment group at the general engineering and consulting laboratories of GE. For the last seven years he has been in charge of development at the Potter Instrument Co.

### Hallicrafters Promotes Two Engineers

CHARLES T. CARROLL has been promoted to vice-president-engineering, of the Hallicrafters company. He was formerly director of engineering for Hallicrafters and has been with the company since 1946. In his new position, he will devote his time to advance systems development of airborne equipment.

W. F. Frankart will replace Carroll as director of engineering. Frankart was chief engineer of Hallicrafters airborne division and has been with the company since 1949.

### DuMont Names General, Selects Tube Head



Raymond C. Maude

MAJOR GENERAL RAYMOND C. MAUDE, former commander of the Air Force Cambridge Research Center, Air Research and Development Command, has joined A. B. Du Mont Laboratories.

General Maude will assist T. T. Goldsmith, Jr. in directing and coordinating the firm's program of supplying electronic equipment to the armed services.

As Commander of the Cambridge Research Center, General Maude has been closely involved with the Lincoln Laboratory and master planning for the continental defense of the United States, as well

## CANNON PLUGS

FOR YOUR  
Miniaturization Program



TYPE "D" . . . UP TO 50 CONTACTS

Save space . . . save weight . . . rugged. 1000's of uses! Pressed steel shells. Heavily gold-plated copper-alloy 5-amp. contacts give untarnishing high surface conductivity and corrosion resistance. Take #20 solder-tipped wires. Polarization means. Salt-spray resistant shells. Flashover 1700 vdc.

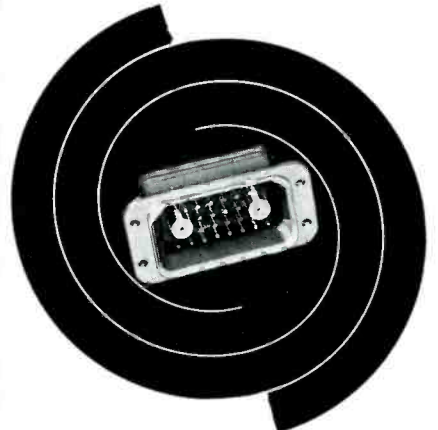

TYPE DPA-DPX . . . UP TO 40 CONTACTS  
15 DPX and 2 DPA layouts, or  
a total of 17 rack/panel layouts.

### Small Connectors of Great Strength

DPA-DPX Miniature connectors give desired contact capacity in 35% less space. For "unit-plug-in" applications. Strong aluminum shells. Chamfered lead edges permit blind piloting. Corner-keying prevents mismatching. Hi-dielectric insulation. Gold plated contacts, 5 amp. and coaxial.

Write for Miniature—Sub-Miniature Bulletin  
Please Refer to Dept. 120

CANNON ELECTRIC COMPANY, 3209  
Humboldt St., Los Angeles 31, Calif.  
Representatives and Cannon distributors in all principal cities.



Since 1915

## CANNON ELECTRIC

Want more information? Use post card on last page.

October, 1956 — ELECTRONICS

as other advanced military programs.

Du Mont also announced Joseph P. Gordan was appointed assistant director of the tube research division. He had served as the division's administrative assistant and manufacturing department manager.

### Airtron Opens Ferrite Division

AIRTRON, INC. has opened a new ferrite division in Cambridge, Mass.

Known as the Cambridge division of Airtron, the new ferrite center includes research, design, development and production facilities. The Airtron ferrite materials laboratory, formerly located at the main plant buildings in Linden, N. J., has been transferred to Cambridge where it has been expanded to provide microwave ferrite materials as well as develop advanced techniques for newer ferrite components.

In charge of the new Cambridge division is Ernest Wantuch, who was appointed vice-president of Airtron. Prior to joining the firm, Dr. Wantuch was section manager in charge of microwave development at the missile systems division of Raytheon. Previously, he was associated with the Fairchild Engine and Airplane Co.

### Burndy Engineering Expands Activities

BURNDY ENGINEERING OF NORWALK, CONN. has organized an Omaton division, serving the electrical and electronic manufacturing, military and aircraft markets. The firm manufactures electrical connectors.

The company dedicated its new plant in Milford, Conn., as the principal manufacturing facility of the Omaton division. Starting with 100 employees and 27,000 sq ft floor area, the Milford plant is expected to expand its capacity threefold in the near future. The firm now has total floor space of 360,000 sq ft.

In the past two decades, Burndy's sales have grown from little over \$1 million in 1937 to an

## TEST COILS ... in one fast, simple operation before assembly

### for SHORTS and OPEN CIRCUITS

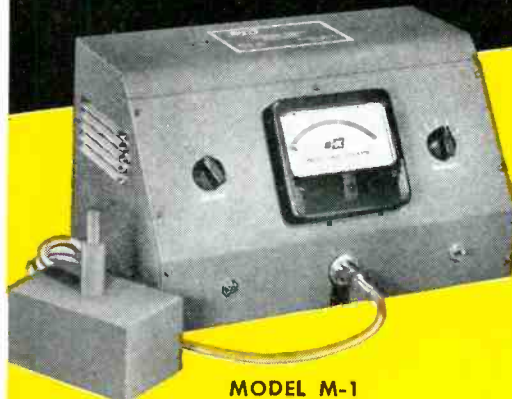

MODEL M-1

## NEW B&K SHORTED TURNS INDICATOR

Gives "Go—No Go" Indication for

- PRODUCTION TESTING
- INCOMING INSPECTION
- LABORATORY USE

This unique new "M-1" coil tester prevents losses in material and labor by finding shorts and open circuits before the coil is mounted onto a relay, transformer or other device. Adjustable sensitivity provides selective testing—permits passing or rejecting coils with any particular number of shorted turns. Actually measures the coil "Q" but under conditions whereby a small difference in "Q" can easily be detected. Fast, easy to use. Safeguards are built-in. No shock hazard to operator. Operates on 110-120 volts, 60 cycle AC.

NET \$179<sup>50</sup>

## CHECK and ADJUST YOUR TEST INSTRUMENTS with LABORATORY ACCURACY



MODEL 750

## NEW B&K TEST EQUIPMENT CALIBRATOR

Voltage Accuracy  $\pm 1\%$  or Better  
Stops losses due to instrument errors.

Enables you to use inexpensive test instruments and yet maintain testing accuracy.

Accurately calibrates VOM, VTVM and other meters, signal, sweep and marker generators, and oscilloscopes. Provides: DC and AC voltages for checking voltage ranges—standard resistances from 10 ohms to 10 megohms for checking reliability of resistance ranges—crystal oscillator generating harmonics over 300 mc. for use as marker generator, and to align audio I.F. system—built-in tone generator for signal tracing amplifiers in all audio equipment. Measures peak-to-peak voltages of unknown waveforms. Complete with 5 mc crystal. Operates on 110-120 volts, 60 cycle AC. NET \$54<sup>95</sup>

Send for informative Bulletins M-1-K and 750-K.

**B & K MANUFACTURING CO.**  
3726 N. Southport Ave. • Chicago 13, Illinois  
Also Makers of DYNA-QUIK, CRT and DYNA-SCAN

# B&K

## Dependable high vacuum pressure monitoring during processing!



**Ionization Gauge  
and Amplifier  
cover  $10^{-4}$  to  $10^{-7}$  mm Hg.**



**New Model 193A Ionization Gauge and Model 192A Ionization Gauge Amplifier** provide a convenient, accurate and dependable method of monitoring pressures from  $10^{-4}$  to  $10^{-7}$  mm Hg. The ion gauge can operate for months without attention; the cost and inconvenience of burned out gauges, poisoned cathodes, grid heating, etc., is eliminated.

**Sierra 193A Ionization Gauge** has a monel-encased interaction space with case near ground potential. A nichrome wire anode at 2.5 Kv is centered inside the case. An insulated out-gassing heater is mounted nearby. An insulated kovar tube is provided for connection to the vacuum line. Permanent magnets in the shell provide the magnetic field, with the shell serving as a return magnetic path, connection block, envelope and heater oven. Electrical connections are made to external binding posts. The tube weighs 22 oz., measures 7" x 5" x 3½".

**Sierra 192A Ionization Gauge Amplifier** consists of a high voltage rf power supply, voltmeter, heater transformer and self-regulating low voltage power supply. It provides range switches, a special leak-check range for full scale meter deflection at any pressure, built-in calibrating circuits, and a heater switch for out-gassing the gauge tube. The instrument operates on 115 v 60 cycle power, measures 10" x 8" x 8" and weighs 17½ lbs.

*Specifications subject to change without notice*

WRITE FOR COMPLETE DETAILS

# sierra



### Sierra Electronic Corporation

San Carlos 2, California, U. S. A.  
Canada: Atlas Radio Corporation, Ltd.  
Toronto, Ontario

Manufacturers of Carrier Frequency Voltmeters, Directional Couplers, Wave Analyzers, Line Fault Analyzers, Wideband RF Transformers, Custom Radio Transmitters, VHF-UHF Detectors, Variable Impedance Wattmeters, Reflection Coefficient Meters, Colorimeters, Water Loads, Thermopiles, Ion Gauge and Ion Gauge Amplifiers, Phase Changers.

Sales representatives in major cities

annual rate of over \$20 million in 1956.

Officers of the firm include: Bern Dibner, president and founder; Marvin Lee, executive vice-president; Julian Rogoff, vice-president and general manager, Omaton division; Eric E. DeMarsh, vice-president and general manager, utility-industrial division; Sidney Wolberg, secretary and director, Stanley W. Loomis, treasurer and director and George M. Szabad, legal counsel and director.

The company has a new mobile display unit to show products of the Omaton division throughout the U. S. and in Canada.

### Consolidated Electro-dynamics Names Engineer



Philias H. Girouard

PHILIAS H. GIROUARD, chief engineer, U.S. Navy Bureau of Ordnance, has been appointed assistant director of engineering at Consolidated Electrodynamics Corp.

During his 13 years in the government post, Girouard received the Presidential Medal for Merit for engineering leadership and accomplishment throughout World War II and the Distinguished Civilian Service Award, the Navy Department's highest civilian honor.

### Hancock Electronics Elects Ogilvie

ALLAN R. OGILVIE has been elected vice-president of Hancock Electronics Corp., manufacturer of closed circuit television equipment in Redwood City, Calif.

He previously was vice-president-

are you  
**LOOKING**  
for fine  
pitch  
precision  
gears?

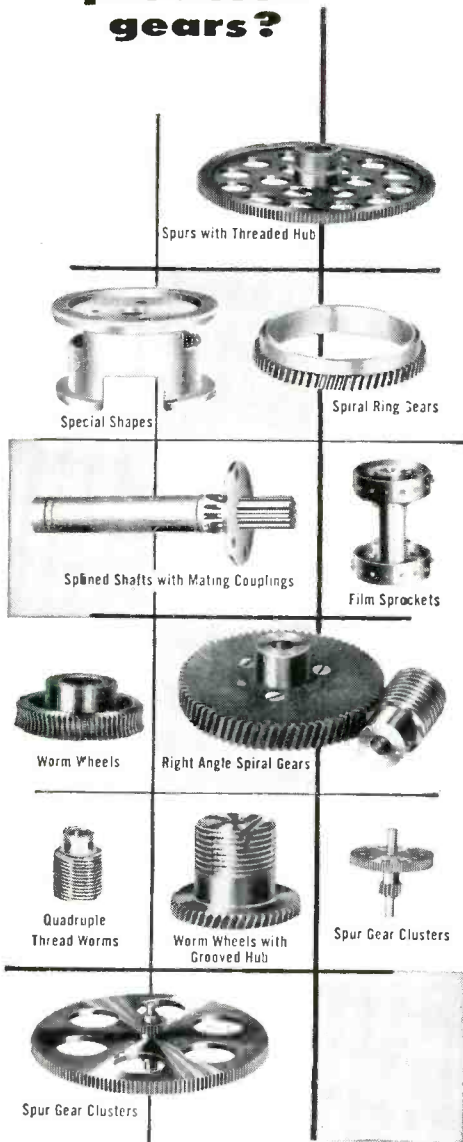

If your requirements  
include  
 $\frac{1}{8}$ " to 5" O.D.—180-16 D.P.  
AGMA Precision #3

Then, write us for  
prompt response, today!

**H. O. Boehme, Inc.**

Designers and Manufacturers

Communication Equipment

Precision Electro-Mechanical

Apparatus Since 1917

915 Broadway

New York 10, N. Y.



Want more information? Use post card on last page.

ELECTRONICS — October, 1956

PLANTS AND PEOPLE

(continued)

manufacturing of Remler Co. of San Francisco. He was with Remler for 10 years, starting as plant manager.

Before moving to the west coast, Ogilvie was vice-president and general manager of the electronics division of Maguire Industries. He started with the company as chief engineer of the electronics division and was later promoted to director of engineering for all divisions.

He was associated with RCA from 1929 to 1944.

**Ferrite Firm Formed  
in San Francisco**



Emo D. Porro

A NEW company, Thermo Materials, Inc., specializing in the development and production of high temperature industrial ceramics, has been formed in San Francisco, Calif.

It is jointly owned by Gladding, McBean and Co. of San Francisco and Los Angeles, Provident Securities Co. of San Francisco, and the Frenchtown Porcelain Co. of Trenton, N. J. The plant will occupy a 2½-acre site near Menlo Park, Calif. It is expected to be in production by December, 1956.

The firm will manufacture and distribute high temperature ceramic and cermet items for the electronic and fabricated metal industries. Ultimately, the firm will expand into other areas of high temperature research.

President of the firm is Emmett G. Solomon, vice-president of Provident Securities Co. Executive vice-president and general manager is Emo D. Porro, formerly of

**NEW**  
*ultra-thin*  
**CHASSIS-TRAK**  
**"DETENT"**  
cabinet slides

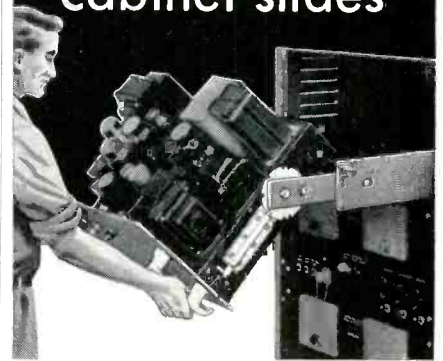

give  
easier access  
and mounting  
for  
electronic equipment

Chassis-Trak "Detent" slides tilt down as well as up to give you ready access to any part of the instrument. Front panel trigger control locks chassis in 7 different tilting positions. Solid bearing surfaces are permanently dry lubricated, glide smoothly without brinnelling or peening under loads up to 175 lbs. Ideal solution to shock or vibration problems. Standard unit accommodates 17" chassis in standard width cabinets 11" to 25" deep. Meets JAN 50-hour salt spray requirements. Now used in many military installations. Available in light, medium, heavy-duty and roller slide models.

write Dept. E-1 for  
equipment bulletin D-151A

**CHASSIS-TRAK CORPORATION**  
525 SOUTH WEBSTER  
INDIANAPOLIS, INDIANA

Want more information? Use post card on last page.



## HYCOR TELEMETERING FILTERS



Hycor band-pass and low-pass telemetering filters are produced in exact accordance with accepted military standards. In addition to designs which conform to Applied Physics Laboratory specifications, miniature units are available.

Hycor telemetering filters are patted for complete protection against vibration and humidity. The finest components are used to minimize aging effects on characteristics.

Send for Bulletin TF which describes standard types available.

Hycor engineers will be pleased to quote on your most exacting specifications.

*Representatives in  
Principal Cities*

### HYCOR

DIVISION OF  
INTERNATIONAL RESISTANCE COMPANY

12970 Bradley Avenue, Sylmar 1, Calif.

Kaiser Industries and Stanford Research Institute. He was engineering assistant to the director at Stanford.

## Sylvania Opens Lab, Appoints Engineers

SYLVANIA opened a new receiving tube engineering laboratory in Los Angeles. It is the second such facility the company has placed in operation to service customer tube problems. It specializes in engineering service and application problems.

Carl A. Peterson was named manager of the new laboratory. He joined the firm in 1950 as an engineer.



Norman L. Harvey

Norman L. Harvey has been appointed operations manager for the tube activities of the electronics division of the company.

He has responsibility for the engineering and production of the line of special-purpose electron tubes manufactured by the division.

He was chief engineer of the radio and television division at Buffalo, N. Y., before he assumed his new duties. He joined the company in 1941 in the radio tube division, transferring two years later to the research laboratories in Long Island, N. Y. In 1949, he became head of the applied research section of the physics laboratory, and a year later was appointed to the radio and television chief engineering post in Buffalo.

Jerome R. Steen has been appointed quality manager—semicon-

## D-B broad band gas-filled cavity wavemeters

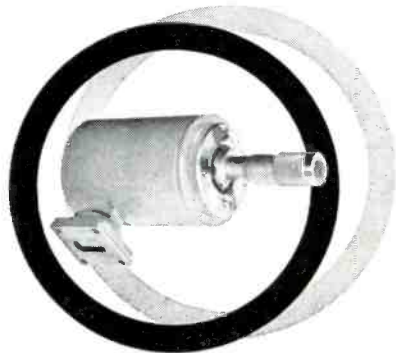

Each instrument covers a wide segment of the total range. Only 11 sizes serve from 2.6 KMC to 90 KMC. Accuracy is so high they may be used as secondary standards. Nitrogen filled and sealed for long life and high Q. Bi-metallic structure provides high degree of thermal compensation. Write for literature.



780 South Arroyo Pkwy. • Pasadena, Calif.

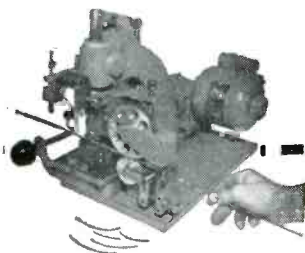

## AUTOMATIC WIRE MARKER

for COLOR MARKING

This ACROMARK Model EMA MARKING MACHINE continuously marks plastic, woven and enameled or lacquered, insulated wire in color. It has an automatic feed for both the cable and the color transfer.

It is only one of several ACROMARK "standardized" types of wire and cable marking machines. Send samples or specifications and a list of codes for literature and prices.

The **ACROMARK** Company

323 Morrell St., Elizabeth 4, N. J.  
"The Original Marking Specialists"

Want more information? Use post card on last page.

Want more information? Use post card on last page.



ductors of the electronics division of Sylvania.

He had been manager of quality control for the radio and television division at Buffalo, N. Y. He has held various quality control positions in Sylvania for 25 years, beginning as supervisor in charge of finished tube quality in 1931 at the Emporium, Pa., radio tube plant.

Sylvania also announced that the operations of the radio and television division in Buffalo will be relocated in the firm's television set plant in Batavia, N. Y. by the end of the year.

An expansion program will be undertaken in Batavia to accommodate some 250 to 300 employees that will be transferred there.

Robert Thalner was appointed chief engineer of the radio and television division. He has been engineering manager, television chassis. He joined Sylvania in 1943 as a research engineer.

Before joining the firm, Thalner was a project engineer on missile television with RCA and was manager of studio equipment design with Raytheon and later with Farnsworth Electronics.

► **Parts**—The parts division of Sylvania has purchased the Titusville, Pa., plant of Ruel H. Smith Enterprises.

The 45,000 sq ft plant, which has been operating on a subcontract for Sylvania for six years, assembles electronic components for the television and radio industry and lamp-holders for the lighting field.

The newly-acquired plant employs about 190 people.

Raymond J. Ledebur, who is manufacturing superintendent of the facility, will continue in that post under the Sylvania operation.

### Magnavox Names Division Head

DAVID W. MARTIN has been appointed manager of the government products division of Magnavox, succeeding the late Barry Carlton.

Martin held the position of project engineer and research project engineer with Bendix Radio over a period of years and later, spent

# BIRD Model 43 *ThruLine* DIRECTIONAL WATTMETER

*Reads Directly . . . WATTS FORWARD*  
**WATTS REFLECTED . . . In 50 Ohm Coaxial Lines**

Measures POWER into the antenna in the actual operating circuit. Continuous monitoring if desired.

Measures reflected power, direct reading. In antenna matching work, results show directly in lower reflected power. Ideal for mobile equipment.

Tests 50 ohm r-f lines, antenna connectors, filters—quickly. **ACCURATE** because of high directivity and small frequency error.

**DIRECT READING**—no calibration charts, no full scale meter adjustments needed. Meter scale reads directly for all ranges and is expanded for better down-scale reading.

**CONVENIENT**—does not require reversal of r-f connections. No auxiliary power required.

Negligible power loss and insertion VSWR. Full scale power range and frequency range are determined by the selection of plug-in elements from the following list.

**Frequency Range**—25-1000 megacycles in five ranges vis. 25-60 (A), 50-125 (B), 100-250 (C), 200-500 (D), 400-1000 (E).

**Power Range**—10, 25, 50, 100, 250, and 500 watts full scale. Available in most frequency ranges.

**Accuracy**— 5% of full scale.

Write for literature.

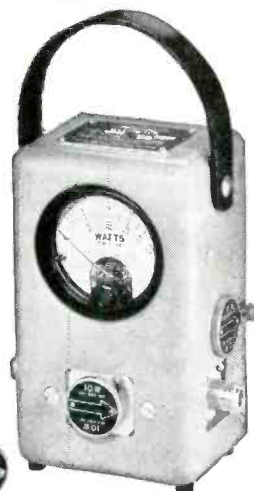

Model 43 with front element in operating position. Dimensions: 7" x 4" x 3" Weight, 4 pounds. SO239 jacks for PL259 plugs available.



**BIRD ELECTRONIC CORP.**  
 1800 EAST 38<sup>TH</sup> ST., CLEVELAND 14, OHIO  
**TERMALINE Coaxial Line Instruments**

**VAN GROOS COMPANY**  
 Sherman Oaks, Cal.

# YOKE SPECIALISTS



COMPLETE LINE of deflection yokes for every need including military and special yokes. Focus Coils for tough problems. We'd like to help you with new applications. Write or phone Dr. Henry Marcy today.

*syntronic*

**INSTRUMENTS, INC.**

170 Industrial Road • Addison, Ill. • Phone: TErrace 4-6103

## Mars Pencils Sponsors Tomorrow's Designs

MARS OUTSTANDING DESIGN SERIES—featured in the current advertising of J. S. Staedtler, Inc.—has attracted widespread attention among the users of fine drafting pencils. It has fulfilled our expectation that the men who appreciate the finest working tools are those with a lively creative interest in new designs, new projects, new ideas.

Concerned with unusual projects—*designs of the future*—Mars Outstanding Design Series provides a “showcase” for originality, for interesting work of engineers, architects, and students which so often lies buried. To stimulate you to send in *your* designs, Mars Pencils

### will pay you \$100

for any design accepted. This \$100 is paid you simply for the right to reproduce your project in the Mars Outstanding Design Series. There are no strings attached. You will be given full credit. (See ad on facing page—one of the ads in the current series.) All future rights to the design remain with you. You can reproduce it later wherever you like and sell or dispose of it as you wish.

The subject can be almost anything—aviation, space travel, autos, trains, buildings, engineering structures, household items, tools, machines, business equipment, etc. It should be a project that appeals to design-minded readers, be of broad interest, and be attractively presented. Do not submit a design that has been executed. As a matter of fact, the project does not need to have been planned for actual execution. It should, however, be something that is either feasible at present or a logical extension of current trends. It cannot be unrealistic or involve purely hypothetical alterations of natural laws.

There is no deadline for entries but the sooner you send yours in, the greater the probability of its use as one of the subjects in the 1957 Mars Outstanding Design Series.

#### It Is Simple To Submit a Design For Mars Outstanding Design Series

Just mail in an inexpensive photostat or photocopy of the subject—one you can spare, since it cannot be returned.

If your entry is accepted, we will ask you to send in a sharp photograph of the design, or the design itself, so that we can make a sharp photograph suitable for reproduction—after which it will be returned to you promptly.

Send your entry to:

### J.S. STAEDTLER, INC.

DICAROLIS COURT, HACKENSACK, NEW JERSEY

Want more information? Use post card on last page.

several years in the design and construction of tv broadcasting stations.

He joined Magnavox in 1950. His previous position with the company was manager of government sales.

### Rauland Buys Plant Space

ZENITH RADIO'S Rauland Corp. has purchased the Charles Bruning Co. property in Chicago.

It consists of 60,000 sq ft of factory space and 100,000 sq ft of land. Rauland will use the property to expand its cathode ray tube manufacturing operations and to increase efficiency by consolidating some of the company's operations that are now being done elsewhere.

### Hughes Acquires Research Firm



HUGHES AIRCRAFT Co. has acquired all the stock of the Santa Barbara Research Center in Goleta, Calif.

The Research Center is engaged in electronics research including infrared detection techniques and electro-optical mechanisms and is manufacturing an infrared detection device. It will continue its current activities as a supplement to the Hughes research and development laboratories in certain specific fields.

David H. Evans, founder and president of Santa Barbara Research, will continue in charge of its operation. The firm employs 40 people.

Evans, a former Hughes execu-

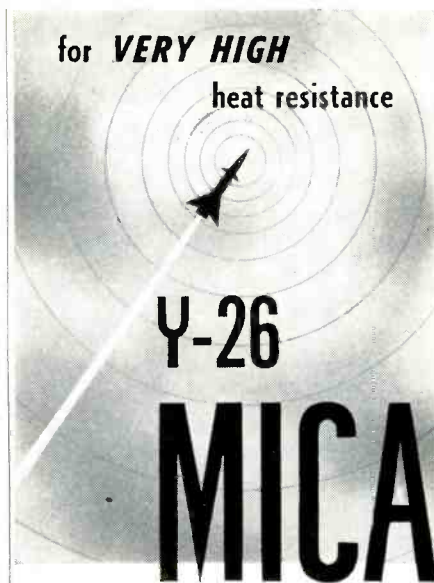

CONSIDER the tremendous possibilities of mica for that new product you're developing or the present one you're improving.

Glance over this quick check list. The solution to your problem may lie in one of mica's unique properties.

- Completely inorganic and smokeless
- High mechanical integration and strength
- Outstanding electrical insulation value
- High reflective value to permit quick and uniform heating
- High durability and moisture resistance
- Complete resistance to temperatures of redness
- Chemically unreactive with resistor materials
- Unaffected by oils or organic solvents
- Does not deteriorate when stored
- Can be stamped cleanly to specified dimensions
- Available in large sheets



We have the facilities to supply you promptly with sheets or pieces punched to your exact specifications. Send today for generous working samples and 36-page reference catalog.

NEW ENGLAND

Mica co.  
INCORPORATED

Waltham 54, Massachusetts

Want more information? Use post card on last page.

five, was one of a small group of engineers responsible for Hughes entry into the electronics field. He joined the company in 1938 to help set up radio-communications for Howard Hughes record-breaking around-the-world flight during which an air-to-ground radio link covering 5,730 miles was maintained. Following the flight Evans remained with Hughes Aircraft in the service and flight department, later as a chief radio engineer and, finally, as manager of the then small electronics department.

Dr. Custer C. Baum is technical director of the company with the title of chief engineer. He also formerly worked for Hughes Aircraft.

### Fairchild Names Two Executives

MAJ. GEN. KENNETH P. McNAUGHTON, USAF (Ret.), recent vice-commander of the Far East Air Force, has been named director of west coast operations for Fairchild Camera and Instrument Corp. He will hold a top level staff position as part of the parent company organization and will be particularly concerned with the company's reconnaissance systems division in connection with the determination of long-range future requirements of the military, involving photo and other kinds of reconnaissance systems.

Raul H. Frye has been appointed general manager of the electronics division of Fairchild. The division



Raul H. Frye

## MARS outstanding design SERIES

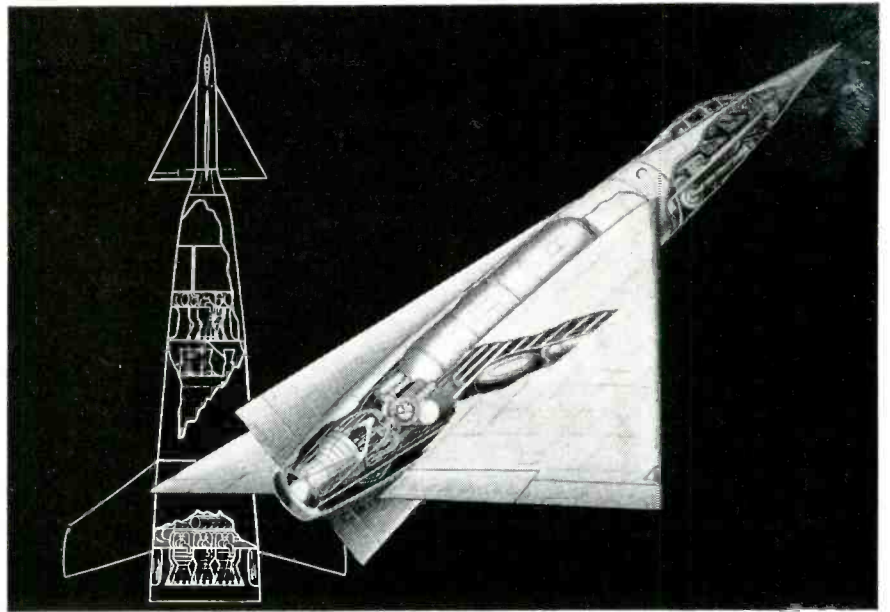

### 3 stages to space

The designs that will make news tomorrow are still in the "bright idea" stage today—or perhaps projects under development like this three-stage, two-man space ship. Drawn by Fred L. Wolff for Martin Caidin's "Worlds in Space," the rocket craft would start out as shown in the reverse drawing at left, shed its propulsion boosters in two stages as fuel is exhausted, and end up as the trim plane-like ship at right. Ship is planned to orbit a hundred miles above earth, return safely after one to two days.

No one knows what ideas will flower into reality. But it will be important in the future, as it is now, to use the best of tools when pencil and paper translate a dream into a project. And then, as now, there will be no finer tool than Mars—sketch to working drawing.

Mars has long been the standard of professionals. To the famous line of Mars-Technico push-button holders and leads, Mars-Lumograph pencils, and Tradition-Aquarell painting pencils, have recently been added these new products: the Mars Pocket-Technico for field use; the efficient Mars lead sharpener and "Draftsman's" Pencil Sharpener with the adjustable point-length feature; and — last but not least — the Mars-Lumochrom, the new colored drafting pencil which offers revolutionary drafting advantages. The fact that it blueprints perfectly is just one of its many important features.

The 2886 Mars-Lumograph drawing pencil, 19 degrees, EXEXB to 9H. The 1001 Mars-Technico push-button lead holder. 1904 Mars-Lumograph imported leads, 18 degrees, EXB to 9H. Mars-Lumochrom colored drafting pencil, 24 colors.



**J.S. STAEDTLER, INC.**  
HACKENSACK, NEW JERSEY

at all good engineering and drawing material suppliers

Want more information? Use post card on last page.

# direct measurements on TRANSISTORS!



... using MEASUREMENTS'  
STANDARD TEST SET  
for Transistors

Model 505



- Provides rapid "go-no go" transistor testing — important for quality control, production, engineering groups.
- Useful for comparison of incoming or untested transistors with a reference transistor which meets device specifications.
- Extremely flexible — utility and type of measurement can be established by use of auxiliary equipment — makes all measurements.
- "h" or "r" parameters are measured by connecting external test equipment to applicable jacks and terminals on front panel.

Measurements' Model 505 Standard Test Set for Transistors is a self-contained, battery-powered instrument designed for rapid d-c measurement of important junction transistor parameters. Permits multiple testing of PNP and NPN small-signal, medium-power, and switching (computer) transistors.

#### SPECIFICATIONS

**DIRECT MEASUREMENTS:** Makes fundamental d-c measurements on small-signal, medium-power, and switching transistors operating in the common-emitter configuration.

Measures collector-to-emitter leakage current from 0 to 10 ma; measures collector current from 0 to 10 ma.

Measures direct current gain (d-c Beta) or "incremental current gain" from 0 to 200, or as calibrated. Indicates  $G_m$  from 0 to 0.39 mhos.

**AUXILIARY MEASUREMENTS:** External test equipment can be used for dynamic measurement of "h" or "r" parameters and switching transistor characteristics up to the megacycle region for selected values of operating biases.

**POWER SUPPLY:** Collector supply voltages of 6 and 12 volts from internal batteries, or from suitable external power supply.

Laboratory Standards



**MEASUREMENTS CORPORATION**  
BOONTON • NEW JERSEY

Want more information? Use post card on last page.

was acquired in 1955.

Frye was recently associated with American Machine and Foundry Co. in Boston, where he was general manager of the company's electronics division.

## Packard-Bell Selects Jones



Kenneth L. Jones

KENNETH L. JONES has joined Packard-Bell as assistant chief engineer for the technical products division.

Jones, formerly with Sylvania Electric as an engineering manager in its microwave laboratory, will be largely concerned with mechanical engineering activities in his new position. His experience also includes five years as a project engineer with the Dalmo Victor Co. in San Carlos, Calif.

## Batdorf Joins Lockheed Missiles

SAMUEL B. BATDORF has joined Lockheed Missile Systems division's research branch as assistant director and head of the electronics division.

He will direct the missile division's activities in electronics research, electronics development, flight test electronics, and advanced telemetering development.

Before joining Lockheed, he had been with Westinghouse Electric since 1951 where he was for a while manager of development in materials engineering and later director of development, engineering headquarters staff.

He served from 1948 to 1951 in

# Malco IS YOUR BEST SOURCE FOR SOLDERING LUGS TERMINALS PRINTED CIRCUIT HARDWARE

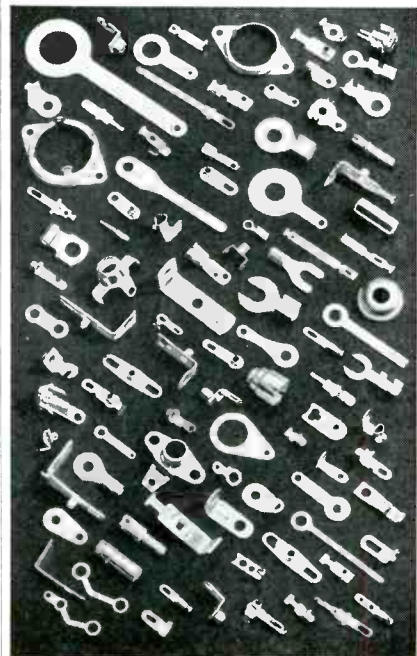

### HERE'S WHY:

- Specialized high production techniques afford lowest possible unit cost.
- Precision tooling, rigid quality control assure tolerances to critical specifications.
- Ample stocks of over 1000 different parts permit prompt delivery.
- Malco specializes in a complete line of small stampings for Radio-TV, electrical/electronic and automotive industries.
- Our line includes terminals and printed circuit hardware in loose or in chain form for automatic insertion.

Let Malco show you how you can save on production time and costs. Contact us today.



Request handy reference catalog containing specifications on standard and custom-made lugs, terminals, corona rings, pins, contacts and similar stampings.

**Malco TOOL and MANUFACTURING CO.**  
4023 W. Lake St., Chicago 24, Ill.

Want more information? Use post card on last page.

October, 1956 — ELECTRONICS

the Structures Research Division of the National Advisory Committee for Aeronautics.

## Varo Appoints Chief Engineer



W. D. Fuller

W. D. FULLER has been appointed as chief engineer of Varo Mfg. Co. in Garland, Texas.

Previously he was chief electronics engineer for Engineering Laboratories. His first association with Varo was in 1953 when he was employed as a project engineer on airborne power conversion equipment.

## ACF Promotes Avion Engineers

M. LLOYD BOND has been promoted to plant manager of ACF's Avion division in Alexandria, Va. Arnold Lesti, formerly department head of data processing at ACF Electronics in Alexandria, is now manager of research for the division. Wilfrid A. Yates, who was formerly department head of instrumentation at Alexandria, is now engineering manager.

## Federal Telephone Acquires Equipment

IT&T's FEDERAL TELEPHONE AND RADIO Co. has purchased certain assets of a subsidiary of Electronics Specialty Co. of Los Angeles.

These assets include a line of large-screen oscilloscopes and accessory equipment.

This operation will be merged with that of Federal's instrument division, and manufacture will take

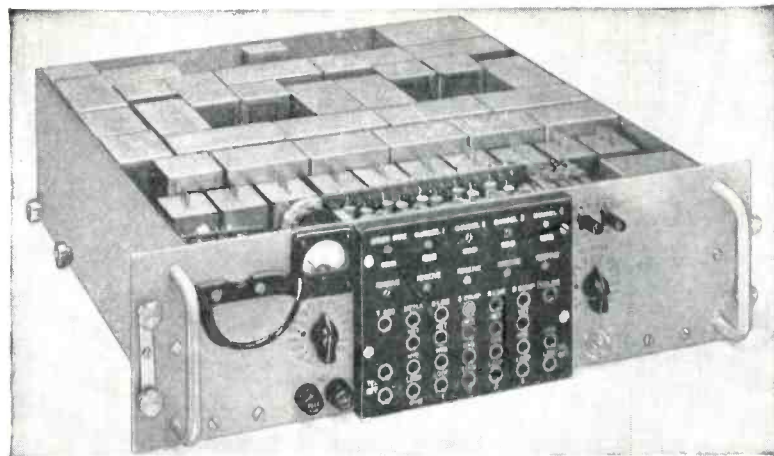

### FOUR-CHANNEL CARRIER-TELEPHONE TERMINAL FOR RADIO LINKS

This is a miniaturized unit of advanced design which provides four voice channels on a frequency-division basis above a voice-frequency order-wire channel. Each of these five channels is provided with a 4-wire 2-wire termination and a voice-frequency ringing circuit for d-c or 20-cycle signals. Adjustable attenuators are provided in the 4-wire side of all channels, and a built-in test oscillator and meter permit complete line-up, maintenance and trouble-shooting checks to be made. Channel levels are from -9 to 0 dbm and line levels from -30 to 0 dbm. Channel width is 300 to 3500 cycles within 1 db.

This unit is only 5 1/4" high by 19" wide by 14" deep. It mounts on a standard rack and operates from 115 volts 50-60 cycles a.c.

## RADIO ENGINEERING PRODUCTS

1080 UNIVERSITY ST., MONTREAL 3, CANADA

TELEPHONE  
UNiversity 6-6887

CABLES  
RADENPRO, MONTREAL

## Less than one part per million impurity

remains during low cost gas purification with

# DEOXO purifiers

NO MAINTENANCE

NO OPERATING COST

NO REACTIVATION

CATALYTIC OPERATION  
AT HIGH OR LOW PRESSURE:

AT ROOM TEMPERATURE:

Removal of oxygen (up to 3%)  
and/or hydrogen (up to 6%)

AT 125° CENTIGRADE:

Conversion of CO to CO<sub>2</sub>

AT 250° CENTIGRADE:

Methanation of CO to CH<sub>4</sub>

AVAILABLE CAPACITIES:

25 CFH to 500,000 CFH and larger. Special units designed for specific requirements.

Write for FREE, informative booklet No. 10 and technical assistance.

**BAKER**  
& COMPANY, INC.

PRECIOUS  
METALS

113 Astor Street  
Newark 5, New Jersey

ENGELHARD INDUSTRIES

NEW YORK • SAN FRANCISCO • LOS ANGELES • CHICAGO

place at the firm's Clifton, N. J. plant, under the Federal name. Certain of the key personnel formerly engaged in this work in Los Angeles will be transferred to Clifton.

### Crosley Selects Research Head



Mark G. Foster

MARK GARDNER FOSTER has been appointed director of research for the Crosley government products division of Avco Manufacturing Corp.

Dr. Foster comes to Crosley from the Cornell Aeronautical Laboratory in Buffalo, N. Y., where he was head of the development division. He joined the Cornell staff in 1945, after being engaged as a physicist in development and product engineering for the Naval Ordnance Laboratory during the war. Previously, he was employed by the Champion Paper and Fibre Company, Hamilton, in research.

### N. Y. Transformer Buys Essex Stock

NEW YORK TRANSFORMER Co. of Alpha, N. J., has acquired stock in Essex Electronics of Berkeley Heights, N. J., to expand its product line.

Newly elected directors and officers of Essex are: chairman of the board, J. B. Schaefer, president of N.Y.T.; president and general manager, B. M. Goldsmith; vice-president, A. W. Adler; secretary-treasurer, Kenneth G. Llewellyn.

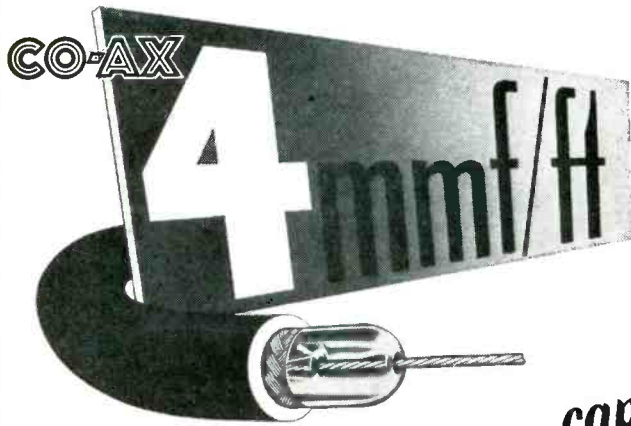

**★ ULTRA LOW capacitance & attenuation**

WE ARE SPECIALLY ORGANIZED TO HANDLE DIRECT ORDERS OR ENQUIRIES FROM OVERSEAS  
 SPOT DELIVERIES FOR U.S.  
 BILLED IN DOLLARS—  
 SETTLEMENT BY YOUR CHECK  
 CABLE OR AIRMAIL TODAY

TYPE	$\mu\text{mF/ft}$	IMPED. $\Omega$	O.D.
C 1	7.3	150	.36'
C 11	6.3	173	.36'
C 2	6.3	171	.44'
C 22	5.5	184	.44'
C 3	5.4	197	.64'
C 33	4.8	220	.64'
C 4	4.6	229	1.03'
C 44	4.1	252	1.03'



**NEW 'MX and SM' SUBMINIATURE CONNECTORS**  
 Constant 50 $\Omega$ -63 $\Omega$ -70 $\Omega$  impedances

TRANSRADIO LTD. 138<sup>a</sup> Cromwell Rd. London SW7 ENGLAND CABLES: TRANSRAD, LONDON

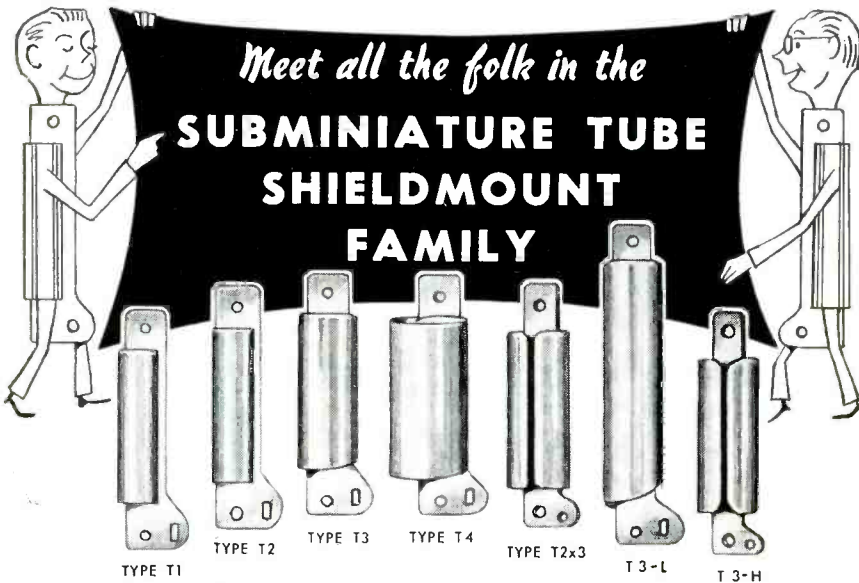

The NEMS-CLARKE Shieldmounts, designed and manufactured by us, have become the standard for the industry. All types are recommended by equipment manufacturers because of these features: Spring temper phosphor bronze, obtainable silver plated, blackened or unfinished \* perforated for riveting directly to chassis or terminal board \* excellent heat dissipating qualities.

NEMS-CLARKE has the facilities to design and produce equipment to your specifications.

**NEMS CLARKE**  
 Incorporated  
 919 JESUP-BLAIR DRIVE SILVER SPRING, MARYLAND  
 For further information write Dept. T-2

## New Books

### Science Encyclopedia To Be Published

A multivolume compendium of the world's technical and scientific knowledge, "The McGraw-Hill Encyclopedia of Science and Technology", is now in preparation at the firm's branch editorial office, Charlottesville, Va. The encyclopedia will comprise more than 7,000 oversize pages and will probably be bound in ten volumes. It will take about three years to complete.

The work will consist of several thousand alphabetically arranged and cross indexed articles written by some 2,000 specialists in science and engineering. The encyclopedia will be pitched at the college upperclassman level in comprehension and readability.

► **Yearbook**—The publishers plan to revise and rewrite articles as new scientific and technological developments occur. An annual publication, "The McGraw-Hill Yearbook in Science and Technology", will provide a complete summary of each year's scientific and engineering progress.

William H. Crouse, author of some 15 technical books, will be editor-in-chief assisted by some 30 consulting editors and an editorial staff of 20.

### Radio Electronics

By SAMUEL SEELY  
McGraw-Hill Book Co., New York,  
1956, 527 p, \$11.50

THIS book would have been of interest if it had been published in the early 1930's. It is a conventional rehash of the many books on the subject which have been published since that time and offers practically nothing novel in material, treatment, or arrangement. The inclusion of an introduction to information theory is a possible exception.

► **Basic Elements**—The first chapter of the book discusses the basic elements of a communication system. It is routine except for the

considerable usage of such terms as frequency-modulated oscillator superheterodyne receiver, reactance tube, mixer and so forth without definition or explanation. It must be bewildering to an actual neophyte in the field and might well scare off a prospective student of the subject.

Chapters 2 and 3 give a good physical description of electronic vacuum tubes, including rectifiers and the filters used to remove their residual ripple. Design equations are given.

► **Circuits**—The next seven chapters comprise a routine discussion of the basic amplifier circuits. These are mildly mathematical but carefully avoid the use of the calculus as an analytic tool. Taylor's expansion is stated but not used. This is especially true of the problems which seem to be designed to test whether the student stayed awake rather than to stimulate ingenuity.

Chapters dealing with oscillators, amplitude modulation and demodulation, and frequency modulation and detection are then presented to round out the book.

► **Information Theory**—An introduction to information theory, ending in an evaluation of a-m, f-m, and various pulse systems in the effectiveness of their ability to trade bandwidth for signal-to-noise ratio, closes the formal portion of the book.

Three appendixes follow: The first gives an elementary discussion of network analysis including some general theorems; the second and third give characteristics of certain vacuum tubes, which may be useful in setting up the problems in the text but which probably are out of date by now.

► **Evaluation**—The bibliography is barely adequate. The format is excellent and the freedom from typographical errors commendable. The index seems good.

This reviewer was stunned to find not one single reference to the transistor.

This book follows a pattern simi-

used by **LEADING  
MANUFACTURERS**  
of transistorized radios

**1 1/2" TRANSISTOR I. F.  
RI-trans**

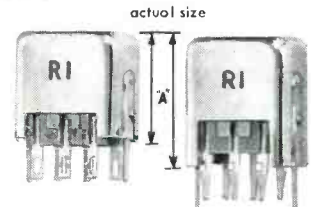

for wired circuit for printed circuit

top and higher low loss  
bottom tuned efficiency dielectric  
base material

Designed to meet any transistor impedance.

	type I	
	W.C.	P.C.
capacity in mfd.	65-450	65-450
"Q"	200 max.	200 max.
dim. "A"	45/64	27/32
	type II	
	W.C.	P.C.
capacity in mfd.	125-450	125-450
"Q"	200 max.	200 max.
dim. "A"	37/64	23/32
	type III	
	W.C.	P.C.
capacity in mfd.	140-450	140-450
"Q"	110 max.	110 max.
dim. "A"	37/64	23/32

also low voltage class 2

**DISC  
CAPACITORS**  
RI-CAP K-500 series

W.V.—30 VDC	cap. in mfd.
I.R.—2500 meg-ohms min.	+100%
P.F.—3% max. at 1 KC	-20%
T.V.—2 X rating	.001
T.C.—from 25°C to 10°C not greater than 20%, and 25°C to 65°C not over 60%	.005
	.01
	.02
	.03
	.05
	.10
	.20

built by RI economical quantity production process

write for details

**RI RADIO INDUSTRIES, INC.**  
5225 no. ravenwood ave.  
chicago 40, ill.

Want more information? Use post card on last page.

for a  
good connection..

USE  
**Automatic  
CONNECTORS**

Up to date production facilities using the most modern high speed, automatic machinery producing quality components for the Electronics and Telecommunications Industries.

Automatic's high standards of quality are based on over 15 years experience manufacturing precision parts for the Army, Navy, Air Force and Atomic Energy Commission.

Prompt engineering service is available for design and production of any special connector or component you may require.

Manufacturers of  
**RF FITTINGS • RF CONNECTORS  
COAXIAL RELAYS • COAXIAL  
SWITCHES • INSULATED CONNECT-  
ING RODS AND SHAFTS • POWER  
PLUGS • AUDIO PLUGS • COAXIAL  
CABLE ASSEMBLIES**

WRITE, WIRE OR PHONE FOR FURTHER  
INFORMATION.



321 Berry Street, Brooklyn 11, N.Y. • EVergreen 8-0364

Want more information? Use post card on last page.

452

NEW BOOKS

(continued)

lar to many radio books which have been published in the last ten years. It is mildly mathematical and could be useful as a textbook where not too deep a basic understanding is required.

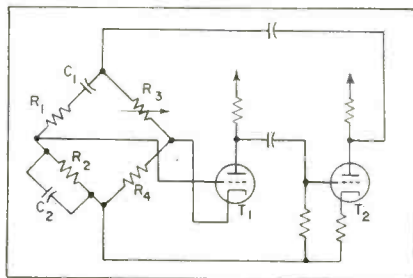

The Wien-bridge oscillator

The format is excellent and the freedom from typographical errors commendable.

It would have been desirable to have included the subject of transistors. — KNOX MCILWAIN, *Burroughs Corp., Paoli, Pa.*

## Principles of Electronics

By L. T. AGGER

*St. Martin's Press, New York, 1956,*  
340 p, \$5.00

WRITTEN in England, this book is intended as a preparation for examinations leading to a certificate in electrical engineering. Accordingly it is replete with sets of sample problems with some worked out for the student as illustrative examples.

In this country, it amounts to a general text on the technical-institute level. As such it is no better and no worse than several adequate texts now in print. As is the case with all British books, slight differences in technical terminology, for example valve for tube, can be distracting at times.

► **Content**—The first four chapters introduce the student to electron flow as it concerns the electronics technician, treating electron dynamics in a basic and qualitative manner, thermionic emission and conduction through gas.

A somewhat novel approach is followed by discussing an electron tube structure and then discussing circuits utilizing the structure rather than relegating a discussion

## 3 ANSWERS TO POWER PROBLEMS

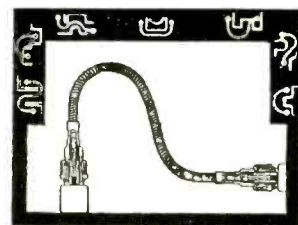

More flexible shafts are being used in the electronic field today because they offer an economy in time, space, and costs.

There are three types of flexible shafts available, each having certain advantages.

The FIRST type of flexible shaft is power drive, which transmits power between two points where, due to position, solid shafts cannot be used. The power drive flexible shaft provides for rotation either clockwise or counter-clockwise with the wire wound according to the direction rotation in order to strengthen the cable while the assembly is in use.

SECOND is the remote control flexible shaft which offers the advantages of rotation both clockwise and counter-clockwise and may function in either a continuous or an intermittent operation. The remote control flexible shaft has proven its value many times where the driven element required only a fraction of a turn or many complete turns and where both rotation and reciprocation were required.

The THIRD type of flexible shafting is the coupling which is an added application of the remote control flexible shaft and is most useful to control the movement of parts within a piece of equipment. There are no alignment problems to contend with because the flexibility of the coupling compensates for any difference in alignment between the drive and the driven elements.

For complete information write Dept. E, F. W. Stewart Corporation, 4311 Ravenswood Ave., Chicago 13, Illinois.

## ✓ O-RINGS ✓ SPECIALTY PARTS ✓ POTTING RESINS ✓ ADHESIVES

Can these unique Bacon Industries' services help you?

... Formulation and testing of rubber and plastic materials — or finished parts made from such materials.

... Laboratory-controlled production of precision silicone and other elastomer O-rings in a broad range of standard sizes or to custom specifications . . . special potting resins, impregnation compounds and adhesives with unusual temperature and dielectric properties.

... Development and design of special rubber, plastic and elastomer parts — and the molds from which such parts are produced.

... Custom molding of parts — on volume production or prototype basis — using silicone, natural rubber, polyethylene, Kel-F Elastomer, and other plastics and elastomers.

Write today for special file folder  
of B.I. Technical Data Sheets

**Bacon INDUSTRIES, Inc.**

192 Pleasant Street, Watertown, Mass.

Want more information? Use post card on last page.

October, 1956 — ELECTRONICS



of all varieties of electron-tube to a single chapter or so. A chapter on the diode is followed by one on rectification. After the triode comes a chapter on amplification. Multi-element tubes are introduced and followed by chapters on multistage, tuned and power amplifiers.

After gas tubes comes a chapter on controlled rectification and inversion. Other chapters deal with oscillators, modulators and demodulators, cathode-ray tubes and photoelectricity.

► **Evaluation**—The book presumes a knowledge of elementary a-c and d-c electricity yet falls short of the engineering level. It would be useful in technical institutes and possibly for self study if the student had adequate electrical background.

Its main shortcomings are that it is weak in pulse circuits that are becoming increasingly important in industrial and military electronics. Furthermore, the student is not given the opportunity to become acquainted with the transistor which he is almost sure to meet later on in his work.

This latter situation causes the transistor to remain for a long time a stranger rather than a familiar alternate to the electron tube.—J.M.C.

### Color Television Standards

BY DONALD G. FINK  
McGraw-Hill Book Co., New York, 1956, 520 p., \$8.50

THE first two chapters of this book constitute an excellent review of the history and background of color television. They are strongly recommended for background reading for the student, for the electronic engineer who is being introduced to color television and for those of us who were confused with the doings of the National Television Systems Committee (NTSC).

Further analysis reveals the book to be a condensation of 4,100 pages of committee reports submitted by 10 panels, 55 subpanels and 315 individuals who studied, analyzed, and in some cases created parts of the finally approved system. The work took 32 months and entailed studies and recommendations that were

# Unitize—Miniaturize

WITH *Vector* STRUCTURES FOR CIRCUITRY

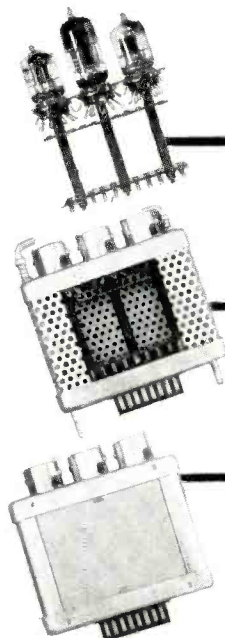

TAKE ONE STRIP TURRET

ASSEMBLE IN LIP-LOC CASE

Result PLUG IN UNIT

Choice of Deck, or Wall type strips in many sizes offer miniaturization, accessibility, ease of assembly and adaptation to semi-automatic machinery.

A sectionalized case with a choice of plugs quarter turn locks, ventilated or solid wall; with two piece center section or snap-open side ports.

For circuit unitization, faster final assembly, stock reduction and ease of maintenance.



VECTOR ELECTRONIC COMPANY, 3352 San Fernando Road, Los Angeles 65, Calif. • Tel. CLinton 7-8237

### A REVOLUTIONARY "First"

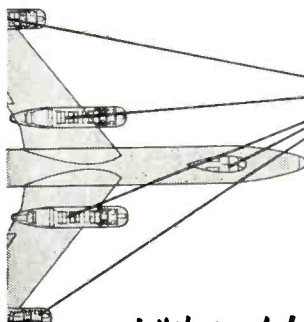

SERVICE-FITTED  
SERVICE-TESTED  
SERVICE-APPROVED

SILICONE IMPREGNATED  
FIBERGLAS CUSHIONED  
**CLAMPS**

Withstand Jet Engine Heat or Stratospheric Cold...

ADEL has the answer to the need for a rugged, heat and abrasion-resistant clamp that can withstand the attack of the stratosphere's sub-zero cold and the intense heat of today's aircraft, missile and rocket power plants. TEMPERATURE CHARACTERISTICS: Far above +550° F. to well below -90° F. Performance far beyond specifications of any other clamp.

Easily installed on "bundle" or removed, and they retain their firm, cushioned grip despite severe vibration and extreme temperatures. Cut maintenance and replacement costs...cushions won't tear during engine harness assemblies and if material chars, due to extremely high temperatures, there still remains a safe, non-conductive layer—A positive "design-fix" for jet engines.

SAMPLES & SPECIFICATIONS: Aircraft, Component & Guided Missile Manufacturers mail coupon today for samples and detailed information on how CLAMPS fit your specific needs.

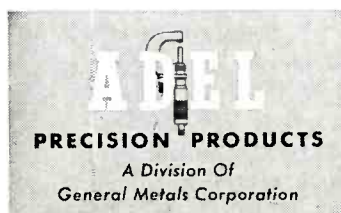

HUNTINGTON DIVISION  
1444 Washington Avenue, Huntington 4, West Virginia

Name \_\_\_\_\_  
Company \_\_\_\_\_  
City \_\_\_\_\_ Zone \_\_\_\_\_ State \_\_\_\_\_

## You Can Now Afford Top Quality Test Equipment!

THE NEW AND VERSATILE



■ Designed for you—and at a price you can afford to pay—precision *service* instruments made by world-famous ADVANCE Components, Ltd. ADVANCE instruments, functionally designed and laboratory engineered, will provide many years of reliable, trouble-free performance.

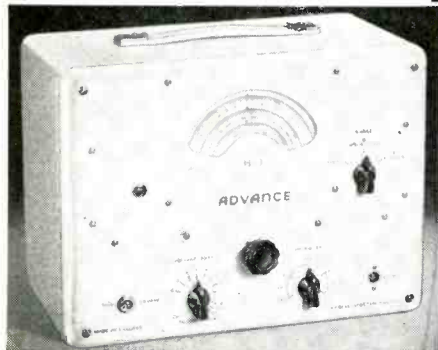

### Sine and Square Wave AUDIO GENERATOR

■ ADVANCE Model 11-1 Audio Generator covers, in three ranges, 15 cps to 50 Kc. both sine and square waves. On *sine* waves, accurate to  $\pm 1\%$ ,  $\pm 1$  cycle; less than 1% distortion at 1 Kc. Output  $\pm 2$  db, 200 uv to 20 volts. On *square* waves, less than 3 microseconds rise time; output 400 uv to 40 volts. **Only \$82.50**



### RF SIGNAL GENERATOR

■ ADVANCE Model P-1 RF Generator covers 100 Kc to 100 Mc on *fundamentals* in six ranges, calibrated to 1%. Output variable from 1 uv to 100 mv,  $\pm 6$  db,  $\pm 3$  uv. 3 Outputs: 75 ohms, 37 ohms, 10 ohms. Audio modulation 30% at 400 cycles; AF output 0-8 volts. **Only \$69.50**

WRITE TODAY FOR COMPLETE SPECIFICATIONS  
Sole United States Agents

FISHER RADIO SALES Co., Inc.  
21-39 44th DRIVE • Long Island City 1, L. I.

particularly comprehensive and accurate since the future of an entire industry was at stake. These committees had to come up with a workable, compatible system that would please everyone and ultimately receive the approval of the Federal Communication Commission.

► **Problems**—From a distance one can now appreciate the complexities of the task when reviewing the divergent interests of the industrial groups who were interested in color broadcasting, the background of electro-political implications preceding the time the committee was formed, plus the somewhat incomplete crystallization of any group upon a system which was final in all technical aspects.

The final results are a tribute to the supreme cooperation of an entire industry when one considers that the entire NTSC operation was rather dimly regarded by the FCC in the early months of its existence. It took a fantastic number of man hours, thousands of committee meetings and a large amount of pure research and development to come up with the final system. The television industry, of course, footed the bill, the committee chairman contributed an untold amount of personal effort, and, above all, the men who steered the committees and coordinated their efforts had rare organizational ability and tremendous forethought.

The situation was as if the government threatened to curtail the manufacture of commercial automobiles until General Motors, Ford, and Chrysler came up with the design of a universal car which was better than any of those being produced by the three companies, which had interchangeable parts with all of them and which would give the public the utmost in cheap, reliable transportation. All this at the companies' own expense, without stepping on anyone's toes, and without obsoleting the already established industry and used car market.

► **Recommendations** — Getting down to technical details of the final recommendations we find them divided into three sections:

1) The study any analysis leading up to the recommendations for a compatible color video signal. This

## STAVOLT POWER RECTIFIERS

30  
Standard  
U. L. Approved  
Models



- Stationary or Mobile Types
- For Hangars, Air Fields, Missiles
- For Factories and Labs

Mag-Amp Control, Stable, Fast  
15 to 1500 amps

Write for interesting  
information to

**CHRISTIE ELECTRIC CORP.**  
Formerly McCOLPIN-CHRISTIE CORP.  
27th Year of Rectifier Manufacturing  
3410 W. 67th St., Los Angeles 43, Calif.



## SPADE BOLTS

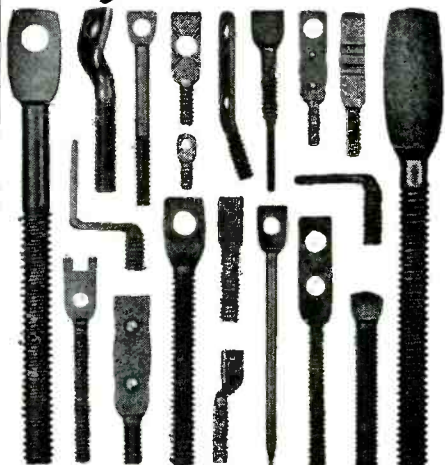

Specialists in designing and manufacturing of all-purpose fasteners and wire forms. Tooled to produce over 1000 styles in any screw size, material, finish, quantity, to your specifications.

Serving Industry for Thirty-five Years  
— OTHER PRODUCTS —

## Simplex WIRE STRIPPERS & CUTTERS

- TOOLS • DIES • STAMPINGS
- Bulletins on complete line upon request

**WENCO MANUFACTURING CO.**  
1133 W. Hubbard St., Chicago 22, Ill., U.S.A.

Want more information? Use post card on last page.

Want more information? Use post card on last page.

Under one roof . . .

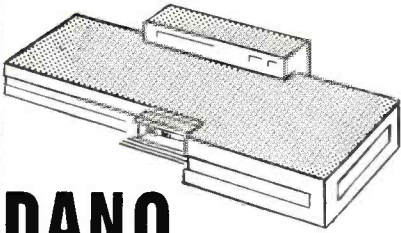

## DANO

makes all these coils to exact specifications:

- ✓ Encapsulated Coils — in either Polyester or Epoxy Resins
- ✓ Coils for High Temperature Applications
- ✓ Bobbin Coils
- ✓ Form Wound Coils
- ✓ Paper Section Coils
- ✓ Acetate Bobbin Coils
- ✓ Cotton Interweave Coils

Analyse YOUR coil problems carefully. If your products require any of these coils you'll do well if you "deal with Dano", leaders in electrical coil windings to customer specification.

TRANSFORMERS MADE TO ORDER



# ENGINEERS . . .

SPECIFY *Hoyt* FOR— ✓ Accuracy

✓ Appearance ✓ Economy

You get big advantages—optimum performance at minimum cost—when you specify HOYT Instruments incorporating more than 50 years' Manufacturing experience. HOYT offers you a complete Line of Panel and Portable Meters in a variety of sizes, ranges and cases . . . Milliammeters, Microammeters, Millivoltmeters, Ammeters, Voltmeters and others—Moving-Coil, Repulsion and Rectifier Types—all designed for today's needs.

Take advantage of HOYT'S lower cost! Write today for complete information and prices on the Meters you need.



POLYSTYRENE CASES  
ANTI-STATIC TREATED



BAKELITE CASES  
ROUND & SQUARE



METAL CASES  
FLUSH & SURFACE

*Hoyt*

## ELECTRICAL INSTRUMENTS

Sales Div.: BURTON-ROGERS COMPANY  
42 Carleton Street, Cambridge 42, Mass., U. S. A.

When  
to specify  
Vulcan  
Electric



### CARTRIDGE HEATERS

1. When application is for: Complete insertion into machine parts, dies, platens, molds, presses, die blocks of embossing machines, packaging machines, etc.
2. When specifications call for: Length — 1" to 25" (or longer); diameter — 1/4" to 1-19/64" (or greater); wattage — 10 to 3200 (or higher); voltage — standard 115 or 230, special 6 to 440; sheath — brass, steel, nickel or high temperature alloys; standard or special lead wires or terminals.
3. When you have "hot" problems: Vulcan Engineers are ready to provide special heating units — engineered to your needs.

Write for free catalog.



ELECTRIC COMPANY  
DANVERS 10, MASS.

Cartridge • Strip • Tubular • Immersion  
Electric Heaters • Soldering and Branding Irons  
Solder and Glue Pots

Research and Development Laboratories!

## Vari-Flex® CHASSIS and POWER SUPPLIES

. . . are designed to save TIME and MONEY

An ultra stable Vari-Flex Regulated Power Supply mounted on a precision Vari-Flex Chassis puts you days ahead in the design and construction of electronic circuitry for research and development—and provides a finished item which conforms to the highest standards of the professional art. The chassis is a precision, pre-drilled and tapped, ready to assemble, unit of great flexibility. The series of four regulated supplies, which amply cover all normal demands of modern electronic circuitry, are soundly engineered and built, ready to connect and operate. Vari-Flex will greatly enhance the efficiency of your organization.

Send for literature and prices!



**Hamner Electronics  
Co., Inc.**

P.O. BOX 531, PRINCETON, N.J. • PENnington 7-1176

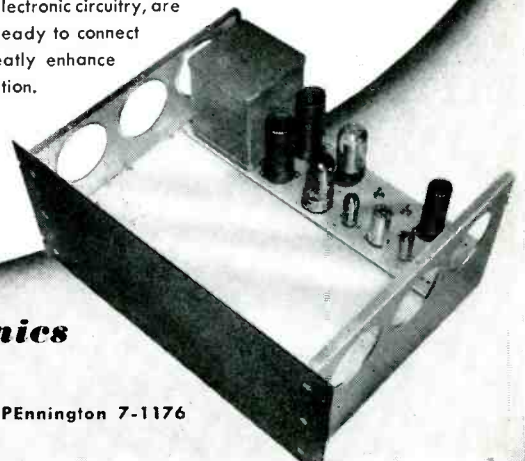

# HYGROCELL

## Humidity Measurement and Control Instantaneously

A new concept in the detection of moisture in the air. No human hair, parchment, block of wood or other absorbing medium used. Since no absorption is required, action is instantaneous, as soon as the moist air strikes the element. Element (using new patented principal) detects the presence of and integrates the water molecules in the air, close to the element. This is indicated by a change in resistance of the element. A standard vacuum tube voltmeter, or other sensitive instrument is suitable for indicating resistance change. For control, a simple one tube amplifier will operate a relay and indicate the humidity on a milliammeter. A variable control in the tube circuit will operate the relay at any humidity point.

Price  
Sample quantities, \$2.00 each HYGROCELL 100-999, 1.50 each HYGROCELL  
Price for larger quantities on request  
Sample sockets for HYGROCELL \$0.30 each

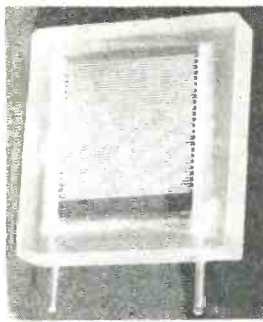

HYGROCELL H-1 Actual Size

Humidity-responsive HYGROCELL is molded in high temperature glasslike plastic. Two contact pins .040" Dia. (Miniature tube pin size) are spaced .750" apart for plugin socket use. Element area is .688" square exposed to atmosphere for instant response to atmospheric moisture change. Overall cell dimensions 1.00 x 1.125 x .250".

Response is instantaneous requiring time only for meter damping when such is used.

Technical assistance is available for the solution of special problems.

### TENTATIVE CHARACTERISTICS

Temp. Range.  $-55^{\circ}\text{C}$  to  $100^{\circ}\text{C}$  (Higher on special order) R.H.—R Range.. 0% relative humidity equals approx. 0 $\Omega$  ohms. (@  $80^{\circ}\text{F}$  or  $27^{\circ}\text{C}$ ) 100% relative humidity equals approx. 50,000 ohms. Maximum recommended cell voltage—110 volts—with current limiting series resistance.

material encompasses the heart of the color tv system. The records and conclusions on studies, colorimetry, matrixing, transmission, proportional bandwidths frequency interlace and two-phase modulation cover the final system in its basic theoretical and mathematical form.

2) The color synchronization signal. The evolution of this signal was simple in comparison to that of the color video signal. The recommendations of course called for correct relationship of the two signals and encompassed studies that related mostly to receiver performance such as signal to noise ratios, synchronizing signals and automatic phase control of the receiver's subcarrier oscillator.

3) Field testing of the system. This lengthy and complicated work had to be repeated in part many times as modifications or conditions changed during the development of the system. Analysis of color performance was a primary testing operation; it was combined and interleaved with compatibility tests, synchronization and transmitter and network evaluation. These latter phases led to exhaustive tests on color films and their processing, plus various aspects of studio and transmission equipment.

Quite appropriately, the last chapter was devoted to the definitions of color television terminology and symbols. In typical NTSC fashion this material is a careful compilation made by a specifically assigned subpanel.

This volume is a nugget—a shiny, well polished one—which concentrates the essence of our present compatible TV system into 500 pages of basic operating facts and fundamentals.—HARRY E. THOMAS, *Montclair, New Jersey.*

### Elements Of Pulse Circuits

By F. J. M. FARLEY  
*John Wiley & Sons, New York, 1956, 143 p., \$2.00*

THIS little book is another one of the extremely useful Metfuen's Monograph on Physical Subjects. It is addressed primarily to physicists and research workers who require an introduction to the subject of pulse circuitry. Thus, the author

## PHOTO-CRYSTALS, INC. 13 S. 1st. St. GENEVA, ILL.

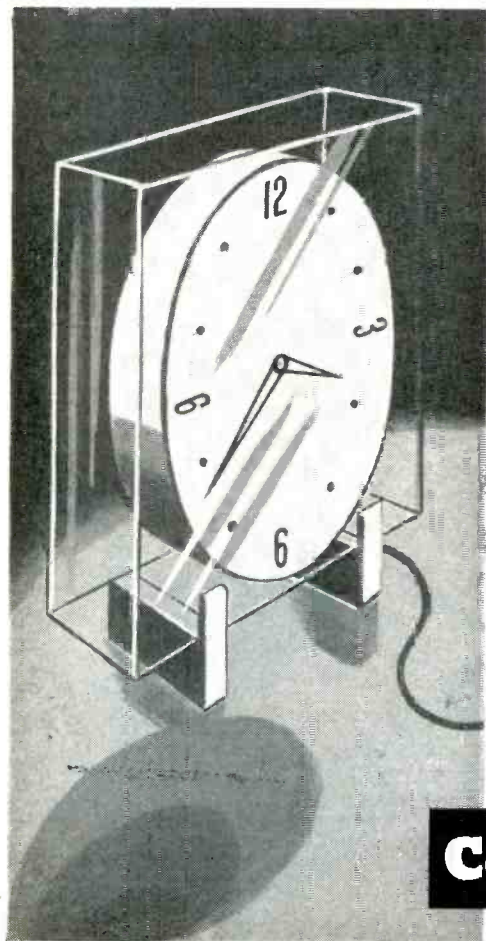

## Your *time* and COTO-COIL

Coto-Coils provide long life and accuracy to some of today's most dependable electric clocks.

Save your valuable time by handing over your coil problems to a specialist—Coto-Coil. With nearly forty years of "know-how" plus the most modern shop practices we can quickly produce the exact coil you need in quantity.

Send details to

COTO-COIL CO., Inc.  
65 Pavilion Avenue  
Providence 5, Rhode Island

PRECISION

Coto  Coils

WOUND

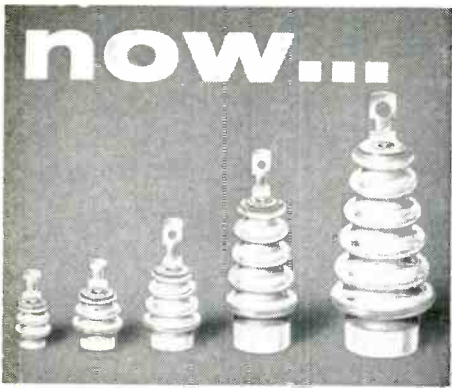

### Frenchtown Metallized Terminals!

Here is Frenchtown's improved line of Annulated Type NICOTE Metallized Hermetic Terminals for use in controls, relays, transformers, capacitors, motors, and heater units. Custom-engineered of HIGH ALUMINA CERAMICS and metallized with our exclusive NICOTE, these terminals are available in six varying sizes with a choice of terminal hardware to fit any exacting application. Write for Engineering Bulletin 1055.

**frenchtown PORCELAIN COMPANY**  
 86 Muirhead Avenue • Trenton 9, N. J.  
 National Representatives: Lundey Associates  
 694 Main St., Waltham 54, Massachusetts

does not develop the circuits from the ground up, so to speak.

The book cover includes square-wave generators, trigger circuits, time bases and pulse amplifiers.

► **Reference**—The book is not a heavy work on circuit design by any means but rather the aggregation of useful pulse circuits pulled together and explained in a sort of quasiquantitative fashion. The author does not make use of transform analyses or other high-powered mathematics. The book should be useful as a quick review, introduction or ready reference for engineers whose work brings them into contact with pulse circuits.—J.M.C.

### Science and Information Theory

By LEON BRILLOUIN  
*Academic Press Inc., New York, 1956, 320 p. \$6.80*

IN this book a distinguished physicist looks at information theory and its relation to modern science. Many persons have probably wondered about the superficial resemblances between information theory and some of the older branches of study, particularly thermodynamics and statistical mechanics.

Words such as entropy and ergodic are shared, the mathematical operations are similar, and theorems on best possible results in ideal cases constitute a common goal. Here is just the book for those who wish to penetrate farther into the meaning of these resemblances.

► **Negentropy** — After developing the basic concepts of information theory in about the first third of the book the author summarizes thermodynamics from a strong information-theoretic point of view. It is found to be no idle coincidence that both information and entropy are proportional to logarithms of probabilities. Entropy with a minus sign appended is not merely analogous but is actually equal to information. Entropy itself is lack of information.

The reviewer's impression is that if the early thermodynamicists had known this, the world might have been spared the creation of the

### NEW PLANT



Our new plant at 5500 Balcones Trail,

with expanded engineering and production facilities, will allow us to maintain prompt delivery of special networks and filters, in small or large quantities.

### MORE PRODUCTION

- RC twin-T networks (Bulletin 500)
- Plug-in feedback nets (Bulletin 572)
- Plug-in amplifiers (Bulletin 212)
- Special LC filters

### NEW PRODUCT

#### BAND PASS AMPLIFIER FILTER

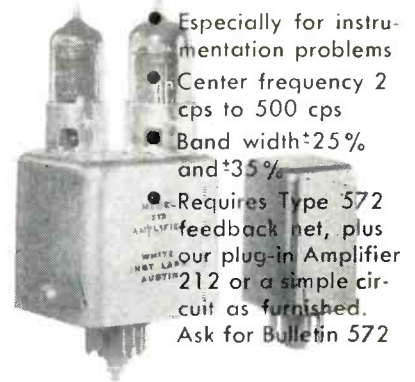

- Especially for instrumentation problems
  - Center frequency 2 cps to 500 cps
  - Band width  $\pm 25\%$  and  $\pm 35\%$
  - Requires Type 572 feedback net, plus our plug-in Amplifier 212 or a simple circuit as furnished.
- Ask for Bulletin 572

### NEW ENGINEERING

New Miniaturizations of RC filters and networks.

New active filter networks

### AT A NEW ADDRESS



INSTRUMENT LABORATORIES  
 PO Box 9006  
 AUSTIN 17, TEXAS

Want more information? Use post card on last page.

I'm Building a College Fund for My Kids with the **EXTRA MONEY** I'm earning in Mobile-Radio Maintenance!

I couldn't set aside from my engineer's salary enough money to send the kids through college. So when I learned of the boom in mobile-radio I decided to start my own part-time business. Now my income from mobile-radio maintenance goes into a "college bank account."

This can be your story, too. Send coupon for your free copy of "HOW TO MAKE MONEY IN MOBILE-RADIO MAINTENANCE." Published by Lampkin Laboratories, Inc., manufacturers of the 105-B Micrometer Frequency Meter and 205-A FM Modulation Meter.

105-B                      205-A

**LAMPKIN LABORATORIES, INC.**  
 Instruments Div., Bradenton, Fla.

At no obligation to me please send "HOW TO MAKE MONEY IN MOBILE-RADIO MAINTENANCE."  
 Name \_\_\_\_\_  
 Address \_\_\_\_\_  
 City \_\_\_\_\_ State \_\_\_\_\_

Want more information? Use post card on last page.

Specify



# PRECISION QUALITY Components

OF TUNGSTEN,  
MOLY, NICKEL CLAD WIRE,  
ALLOYS, KOVAR\*

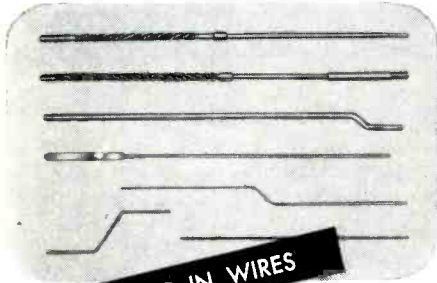

• DKE LEAD IN WIRES

Quality controlled throughout production with Tungsten hard glass leads produced under General Electric Timing Control. Each tungsten lead is microscopically inspected for flaws. DKE offers highest quality and LOW PRICES. Send drawings for quotations and let us prove the economy of our prices.



• DKE TUBE BASES

The Engineering Company can give you immediate delivery on following bases: 50 Watt, 3303B, 412 Industrial Base, Giant 7 Pin Bayonet, 4310 Four Pin Jumbo, Tetrode, Hydrogen Thyatron Bases in both Aluminum and Copper up to 6.50 dia. etc. All bases to JAN-1A/MIL-E-1B and subjected to weights and strength tests.

## DKE HYDROGEN THYATRION TUBE BASES



CALL OR WRITE FOR QUOTATIONS

\*Registered trademark of the Westinghouse Electric Corp.

# THE engineering co.

27 WRIGHT ST., NEWARK 5, N.J.

Want more information? Use post card on last page.

NEW BOOKS

(continued)

mysterious word "entropy." The more familiar word "ignorance" could have sufficed. The second law would then say that in a closed isolated system ignorance must always increase or more accurately can never decrease.

The meaning is that transfer of energy from primary sources to thermal agitation is describable as loss of information. In the language of communication, signals get lost in thermal noise unless something is done from outside to prevent it. It suits the author's purpose to deal with information rather than ignorance and for a thermodynamic synonym he coins the word "negentropy" as a contraction of "negative entropy."

► **Demons**—The concept of negentropy is useful in dealing with the problem of Maxwell's sorting demon. Maxwell conjured up this demon in 1871 as a theoretical way of beating the second law. Its task is to herd the fast molecules into one end of a gas chamber, producing a useful temperature difference.

What would now be called the information-theoretic aspects of the problem were explained as long ago as 1929 in a paper by Szilard. The author reviews this and other contributions including his own and succeeds in exorcising the demon and vindicating the second law.

A condensed explanation is that the demon is so thoroughly embedded in thermal agitation that it cannot make any useful observations without the aid of energy from an outside source. Quantitative studies show that the additional energy would be more efficiently utilized running a heat engine directly than as prime mover for an intermediate program to set up a temperature difference by molecular selection.

► **Measurements**—The author then investigates the limitations imposed by the negentropy principle on physical measurements in general. Measurements of length, frequency, and time are discussed in detail. A concise chapter on telecommunication sums up signaling in the presence of noise as a negentropy problem.

There is a chapter on writing,

# J. I. MORRIS

Gives you EXPERIENCE  
PRECISION AND  
SPECIALIZATION IN

## MINIATURE SCREW THREADS

Many years of specialization in miniature parts and screws plus the latest methods and equipment assure your complete satisfaction with our quality and service.

Brass Screws and Nuts are carried in stock in sizes 00-90, 00-96, 0-80 and 1-72. Other screws and nuts with threads from 56 to 160 per inch and metric as well as small parts can be made to order in any quantity from a single dozen to large production runs.

High Speed and Carbon Steel taps, dies and drills in matching sizes are also available.

Make J. I. Morris Company your one reliable source for all your miniature thread requirements.

Write for our new catalog giving prices and dimensional information.

## J. I. MORRIS COMPANY Southbridge, Mass.

Precision Craftsmen since 1920

How to be the happiest  
creative engineer  
in California

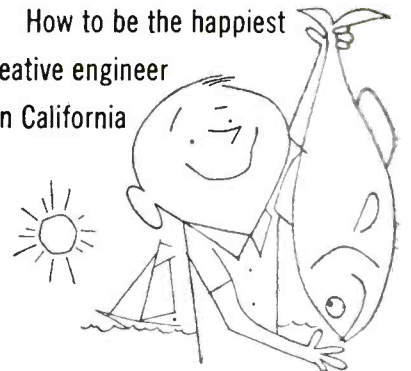

Beckman Instruments, Inc.\* offers E.E.'s, M.E.'s, Manufacturing, and Sales Engineers the kinds of jobs that creative men dream about. Top salary, all employment "extras" including our Educational Assistance Plan, modern facilities and personal recognition that comes naturally with our decentralized operation. Small town living...but near metropolitan areas in either Fullerton, Newport Beach, Richmond, or Palo Alto.

\*We're pacing the commercial electronics field (\$3,000,000 sales in 1949 to \$29,000,000 sales in 1955) and we'll be disappointed if you don't grow with us.

# Beckman

 instruments, inc.

Write Beckman Instruments, Inc., 2999 W. 6th St., Los Angeles 5, Calif. Ask for Career File 52-10. Want more information? Use post card on last page.

October, 1956 — ELECTRONICS

# COHRLASTIC



## TEMP-R-TAPE

PRESSURE-SENSITIVE

## TEFLON TAPE

TEFLON tape with a silicone polymer adhesive backing. An easy-to-apply Class H insulation for slot lining, bundling, splicing, wrapping. Excellent adhesion, elongation and dielectric over entire -100°F to 400°F temperature range. 6 mil and 13 mil thick in rolls and sheets.

FREE SAMPLE and data sheet.

Write direct or use magazine inquiry card.



THE CONNECTICUT HARD RUBBER CO.  
407 EAST STREET - NEW HAVEN • CONN.  
SPruce 7-3631

## NEW METER-RELAYS

FROM 0-5 MICROAMPERES-UP  
Ruggedized - Sealed, Black Bakelite or Clear Plastic Cases

D'Arsonval meters

with locking contacts for sensitive and accurate control or alarm.

TRIP POINT ADJUSTABLE to any point of scale arc. Sensitive to changes as little as 1%.

One contact on moving pointer. The other on adjustable pointer.

When pointers meet, contacts close and lock. Holding coil wound on moving coil. Locking is electro-magnetic. Manual or automatic reset. Spring action kicks contacts apart.

Ranges: From 0-5 microamperes, 0-5 millivolts or 0-300°F up.

Standard Contact Rating 5 to 25 milliamperes DC. Can be up to 100 milliamperes DC.

Ruggedized-Sealed metal cases, 2½", 3½" or 4½" round, shock-mounted movement, gasket-sealed.

Black Bakelite case, 4½" rectangular.

Clear Plastic cases, 2½", 3¾" or 4½" rectangular.

Panel meters and indicating pyrometers also in ruggedized-sealed, black bakelite or clear plastic cases. Write for new 40 page Catalog 4A on meter-relays, meters, pyrometers and automatic controls.

Model 255-C, 0-10 V DC \$42.50

Assembly Products, Inc., Chesterland 4, Ohio. Hamilton 3-4436 (West Coast: Desert Hot Springs 4, Calif. Phone: 4-3133 & 4-2453).

Booth 1702, Metal Show, Oct. 8-12, Cleveland, O.

# CALL YOUR "SWITCHCRAFT" DISTRIBUTOR TODAY FOR THIS HANDY "ADAPTER KIT"!

## SWITCHCRAFT® "ADAPTERS"

For Quick Connection of Equipment Having Different Type Connectors

### NOW AVAILABLE IN THIS STURDY TRANSPARENT CASE

### DON'T WASTE TIME CHANGING CONNECTORS

Be sure to have this ELECTRONIC TECHNICIANS TOOL KIT with 10 different "ADAPTERS" — for adapting different connectors such as Phone Jack Input to Female Microphone Connector Output — and other combinations.

Now used by hundreds of Production, Laboratory, and Testing departments on Sound Equipment, Hi-Fi, Recorders and Musical Equipment.



SWITCHCRAFT ADAPTER KIT No. 33

List. . . \$1470

## SWITCHCRAFT INC.

Chicago 22, Ill.

Canadian Representative: Atlas Radio Corp. Ltd. 50 Wingold Avenue, Toronto, Canada

ORDER FROM YOUR "SWITCHCRAFT" DISTRIBUTOR

## Sonex Transistor Curve Tracer

The curve tracer when used with an oscilloscope, presents one curve at a time of the collector family, ( $V_c$  vs  $I_c$ ) with  $I_b$  held constant. This may be done on all NPN, PNP, surface barrier, grown or diffused junction transistors. The base current is indicated at all times on a four inch panel meter and can be varied from zero to 500 microamperes. The collector current can sweep out to 10 milliamperes while the limits of collector voltage being swept are controlled. Calibrated co-ordinate axes are displayed at all times.

SONEX, INC.

245 Sansom Street, Upper Darby, Pa.



Model CT-103  
120.00

## HIGH ENERGY, PRECISION ALNICO PERMANENT MAGNETS

When you need them—as you need them  
Experimental or production quantities

Catalog upon request

PERMAG CORP., 210 TAAFFE PLACE, BROOKLYN 5, N. Y.

WE CARRY IN STOCK ALL SIZES, ALL SHAPES, ALL ALNICO GRADES

## PERMAG

services include

- ENGINEERING
- PRECISION CUTTING
- PRECISION GRINDING
- MAGNETIZING

24 HOUR DELIVERY

Phone: MAin 2-0114

**HEYCO NYLON STRAIN RELIEF BUSHINGS  
CUT PRODUCTION COSTS AND IMPROVE  
PRODUCT QUALITY**



With Heycos it's no longer necessary to tie wire knots or use insulating grommets. Product life is increased and product appearance is greatly enhanced.

HEYMAN MANUFACTURING COMPANY  
Kenilworth 2 New Jersey



Send wire sizes for free samples and specifications.



**Approved**

**RIBBONS • STRIPS**

- of
- ★ PURE TUNGSTEN
  - ★ THORIATED TUNGSTEN
  - ★ MOLYBDENUM
  - ★ SPECIAL ALLOYS

and OTHER METALS

IN  
**ULTRA THIN SIZES**

to  
TOLERANCES CLOSER THAN COMMERCIAL STANDARDS  
by

**OUR SPECIAL ROLLING TECHNIQUE**

Note: for highly engineered applications—strips of TUNGSTEN and some other metals can be supplied

**ROLLED DOWN TO .0003 THICKNESS**

- Finish: Roll Finish—Black or Cleaned
- Ribbons may be supplied in Mg. weights if required

**For HIGHLY ENGINEERED APPLICATIONS**

DEVELOPED AND MANUFACTURED BY

**H. CROSS CO.**

15 BEEKMAN ST., N. Y. 38, N. Y.  
TELEPHONE: WOrth 2-2044  
COrtlandt 7-0470

printing and reading which deals with storage and recovery of information. The negentropy disappears in any storage process, but since energy must be supplied to read out the information there is no thermodynamic contradiction in its reappearance.

In a chapter on computing, the point of view is taken that computing machines do not manufacture new information but rather act as a transmission channel, which may include coders, decoders, and storage elements. The useful output information is also present in the input data, but not in the form desired. Human processes such as thinking are excluded from the theory since it is not known how to evaluate them quantitatively.

In the final chapter the information represented by complex organizations is evaluated. It turns out that the bit is an exceedingly small unit compared with practical units of negentropy in thermodynamics. The information required to specify even the most complicated man-made system represents a negligible correction to the entropy of the physical parts. It is conceded that the information describing a living organism may reach values of significance in the entropy scale.

The book is most imaginative and stimulating. It can be read for pleasure as well as education.—W. R. Bennett, *Bell Telephone Laboratories, Murray Hill, N. J.*

**Thumbnail Reviews**

**NEL Reliability Bibliography.** W. E. Jorgensen, I. G. Carlson and C. G. Gros. USN Electronics Lab, San Diego, Calif., 1956. Material published since 1950 on circuit design, components, tubes, failure analysis, human engineering, maintenance, mechanical design, systems and testing.

**How To Find a Buyer For Your Invention.** V. D. Angerm. Science and Mechanics Publishing Co., Chicago, 1956, 186 p, \$2.95. When, how and where to sell an invention. Covers patent protection, publicity, advertising; also lists consulting services and manufacturers in search of inventions.

**Time-Saving Network Calculations.** Harry Stockman. SER Co., Waltham, Mass., 1956, 120 p, \$1.75. General rules for network calculations. Covers use of Thevenin's theorem and other techniques for steady state and transients.



## NEW! ENGRAVED Rubber Dies and Stamps!

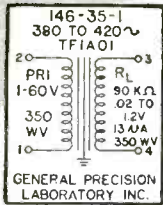

**CLOG  
RESISTANT**

**N  
20**

**ACID  
RESISTANT**

**134**

**LONGER  
LASTING**

● Now you can get clean, clear, sharp, even impressions everytime with Krengel Deep-Kut Engraved Rubber Dies and Stamps. Lasting impressions remain on metals . . . printed materials . . . textiles . . . glass . . . on any surface.

● We make Deep-Kut Engraved Rubber Dies and Stamps for every marking unit . . . any type style or logotypes. Anything you need in any quantity you desire.

● We also make every type of marking machine and can supply you with the proper marking ink.

● Write for free sample and catalogue, or send us your requirements for price quotation.

**KRENGEL MANUFACTURING COMPANY**  
227 FULTON STREET, NEW YORK 7, N. Y.  
TEL. CO 7-5712

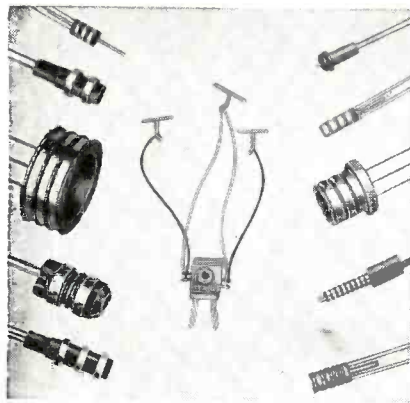

## Miniature and Sub-Miniature SLIP RING ASSEMBLIES BRUSH BLOCK ASSEMBLIES COMMUTATORS

and other  
Electro-Mechanical Components

**PRECISION MADE  
TO YOUR OWN SPECIFICATIONS**

Precision molded products with exacting tolerances in precious and non-precious solid metals of all alloys. All types of Thermo-Plastic and Thermo-Setting materials

Slip Ring Assemblies fabricated or one-piece precision molded to your specifications in Nylon, Kel-F, Mineral filled Mellamine, Phenolic, and other materials. Rings and leads spot welded or brazed together for positive electrical circuit.

**Our Swiss methods and techniques are geared to meet exacting requirements. We invite your inquiries.**

**COLLECTRON CORPORATION**  
MUrray Hill 2-8975 • 216 East 45th Street • New York 17, N. Y.

*for Results*



**Mc GRAW-HILL**  
DIRECT MAIL LIST SERVICE

**McGraw-Hill Mailing Lists  
Will Help You**

- Merchandise your advertising
- Conduct surveys
- Get inquiries and leads for your salesmen
- Pin-point geographical or functional groups
- Sell direct
- Build up weak territories
- Aid dealer relations

Direct Mail is a necessary supplement to a well rounded Business Paper advertising program.

Most progressive companies allocate a portion of their ad budgets to this second medium at the same time as they concentrate on the best business publications.

600,000 of the top buying influences in the fields covered by the McGraw-Hill publications make up our 150 mailing lists. Pick YOUR prospects out of our Industrial Direct Mail catalogue.

Write for your free copy.  
It contains complete information.

**S** IF IT'S **NEW** —  
**Schweber STOCKS IT!**

**Cannon** MINIATURE PLUGS & SOCKETS

NOW, from Schweber stock for Immediate Delivery:  
"KO" connectors for "K" performance in miniaturized form. Available in six keyed positions, 10, 20 and 30 contact configurations (#20 wire max.), also with 45° and 90° end bells. Other Cannon miniatures and "E" connectors in stock.

WRITE for "Bulletin HMC"

Pioneer 6-6520

**Schweber ELECTRONICS**  
122 Herricks Road Mineola, L. I., New York

**FIRST Industrial Component SPECIALIST**

## • IMMEDIATE DELIVERIES • RELAYS & BUZZERS



Medium Duty Power Relays. 6-12-24-115-230 Volts AC. 50-60 Cy. 6-12-24-115 Volts DC. All coils formvar wound. Pure silver contacts. 10 Amp. rating. Minimum contact pressure 25 grams. Dimensions: 2.36" x 1 1/2" x 1-11/16"



AC Vibrating Type Mini-Buzzers. Give clear penetrating signals. Available in 6-12-24-115, 230 & 460 Volt AC ratings. Ideal for all paging systems, warning alarms, signals. All metal case easily mounted with screwdriver.

Catalog information for Relays and Buzzers sent free on request.

**LINE  
ELECTRIC**

**LINE ELECTRIC COMPANY**  
1419 McCARTER HIGHWAY  
NEWARK 4 NEW JERSEY

*In winding Toroids  
on a BOESCH  
machine a finished  
coil can be removed  
and a new one inserted  
ready for winding  
in the time it took you  
to read this far.  
No need to remove  
shuttle or other  
parts.*

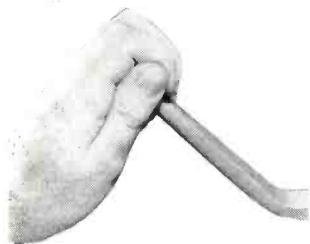

CALL YOUR  
BOESCH REPRESENTATIVE TO SHOW  
YOU THE REST OF THIS PICTURE

## **ONE LEVER**

*controls clamping  
and spreading of  
shuttle -*

## **ONE HAND**

*inserts core and  
removes finished  
coil.*

*Write today for  
complete information  
on BOESCH  
winding machines*



Want more information? Use post card on last page.

## **Backtalk**

### **Power Broadcasting**

DEAR SIRs:

I NOTICED in the July issue of ELECTRONICS, page 180, an interesting writeup on the work of Tesla.

During 1948 and 1949 we were engaged in some experimental work in the transmission of power following a parallel with the work of Tesla. After carefully considering what he had done, we worked out the basic principles of power transmission through the air without wires and proved the laws relative to the possibility of such transmission. Later, we had this checked to prove our findings.

Work was conducted to get a patent but we were informed that the original Tesla patents were so completely covered that we could not be granted further patent protection. The original experiments were carried on in a shielded building and when we wanted to get a license from the FCC to use the frequency which seemed possible we were naturally denied this privilege.

Knowing the effect of power transmission and the danger of burning out receivers tuned to the right frequency the project was discontinued. Later we read of requirements for power transmission without wires, and each time we answered an inquiry nothing further was heard from the source.

Just thought you would be interested to know that power transmission, at least in our estimation, is possible and practical; and, although Tesla did not have suitable electronic equipment, power capabilities and technical information, he still invented a revolutionary system which can be used when the world is ready for it.

JO EMMETT JENNINGS  
President  
Jennings Radio Mfg. Corp.  
San Jose, California

### **Profitable Problem For Design Engineers**

DEAR SIRs:

IN RECENT months there have been

editorial commentaries in ELECTRONICS and letters concerning some of the unexploited possibilities of electronic circuitries, also about work being done without those in other fields knowing of it.

A problem was brought to our attention for which a solution may already exist but of which we are not yet aware, or perhaps a solution can be devised.

A desiccated coconut factory would like to improve the quality of product by more careful grading of the raw nuts before acceptance. Present methods done by men are unsatisfactory due to the inherent difficulties of judgment and because of the possibilities of external influences on the graders. Some improved method, no doubt electronic, could perhaps be devised to do this on a conveyor belt system with an automatic drop-out for rejects.

Desiccated coconut is made by grating the nut meat of the mature coconut, which is then dried by thermo-mechanical means and shipped to the U. S. in large paper sacks. There are several grades, depending on the fineness or the shape of the grated meat.

The average coconut is somewhat larger than a baseball when removed from its protective husk. A ripe, mature coconut has a dark brown, dried-out husk and, when the husk is removed, the shell is dark in color. The meat of this nut is firm and has a moisture content of about 53 percent or lower. The interior of the nut is filled with a liquid called coconut water which fills virtually the entire interior of the nut.

#### *Sorting Problem*

The problem is the elimination of the green nuts. These nuts have a green or mixed green and brown outer skin. The husk has a percentage of moisture content and is lighter in color. The shell is normally light brown or yellow brown

For consistently high purity...

**"LINDE" M.S.C. RARE GASES**  
Trade-Mark (Mass Spectrometer Controlled)

- Helium
- Argon
- Neon
- Krypton
- Xenon

In radar electronic equipment, nuclear radiation counters, cosmic ray cloud chambers, and thyratrons, where the purest rare gases are demanded, LINDE M.S.C. Grade gases meet the specifications. They are produced under continuous mass spectrometer control to assure you of gases of *known* purity and consistently high quality. LINDE, the world's largest producer of gases from the atmosphere, can meet your individual needs of volume, mixture, and container.

For information on the physical, chemical, and electrical properties of these gases, send for the booklet, "LINDE Rare Gases."



**LINDE AIR PRODUCTS COMPANY**

A Division of  
 Union Carbide and Carbon Corporation  
 30 E. 42nd Street **UNION** New York 17, N.Y.

In Canada:  
 LINDE AIR PRODUCTS COMPANY, Division  
 of Union Carbide Canada Limited, Toronto  
 The term "Linde" is a registered trade-mark of Union  
 Carbide and Carbon Corporation.

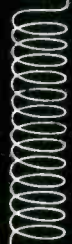

high-vacuum  
 high-voltage  
 rectifier tubes

**DUNLEE**

also a complete line of  
 industrial x-ray tubes

**DUNLEE CORPORATION**  
 4560 West Congress Street  
 CHICAGO 24, ILLINOIS



**All these precision features in a low-priced instrument:**

- |  |  |
|--|--|
| <b>BROAD FREQUENCY COVERAGE—</b><br>10 MC—490 MC                                     | <b>HIGH FREQUENCY STABILITY—</b><br>Completely regulated plate & filament supplies |
| <b>FINE FREQUENCY READABILITY—</b><br>Interpolating vernier with resettable zero     | <b>NEW PISTON ATTENUATOR—</b><br>0.2 microvolt to 0.2 volts output                 |
| <b>ACCURATE FREQUENCIES—</b><br>½% Calibration                                       | <b>CLEAN CARRIER—</b><br>Oscillator tube dc operated, filament & plate             |
| <b>CONVENIENCE MODULATION—</b><br>C.W., 400 cycles, 1000 cycles, with standby switch |  |

This instrument is ideal for use in the communication ranges for both design and maintenance work where the highest performance must be had. Elimination of gadgetry and "sales features" permits inclusion of the finest operational qualities at moderate cost.



**THE CLOUGH-BRENGLE CO.**

6014 Broadway, Chicago 40, Illinois

**PRECISION  
 PLASTIC  
 CAPACITORS  
 AT  
 COMPETITIVE  
 PRICES!**

**POLYSTYRENE and MYLAR\***  
 Capacitance From .001 mfd to any value  
 Voltage From 50 V.D.C. to 30 KV  
 Tolerance Polystyrene From ±0.1% to ±5%  
 Mylar\* From ±1% to ±10%

**SMALLEST CASE SIZES  
 TUBULAR—BATHTUB—RECTANGULAR**

Very Good Deliveries \*DuPont T.M.

**PRECISION CAPACITORS, INC.**  
 319 N. Victory Blvd. Burbank, Calif.

**PALLADIUM • GOLD  
 SILVER • RHODIUM  
 LEAD • other metals  
 PLATED ON  
 ALUMINUM • STAINLESS STEEL  
 MU-METAL • BERYLLIUM COPPER  
 MONEL • PHOSPHOR BRONZE  
 POWDERED METALS ETC.**

- Contact Pins
- Wave Guides
- Conductors
- Cavities
- Terminals

**ELECTRONIC ELECTROPLATING  
 TO EXACTING SPECIFICATIONS**

During the growth of the Electronic Industry, MERIT PLATING CO., has been in the forefront in solving Electroplating problems arising from the highly specified requirements for plating Electronic Components and Equipment.

**MERIT PLATING COMPANY**

216 East 141st Street New York 51, N. Y. CYPRESS 2-6380

# HIGHER EFFICIENCY H-F POWER TRANSFORMERS

THIS IS A TYPICAL FERROXCUBE  
MAGNETIC CORE DESIGN

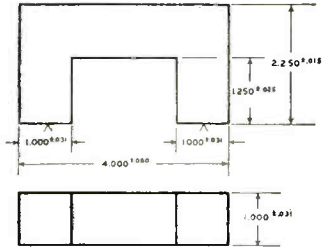

Smaller, lighter and less costly H-F power transformers of outstanding efficiency are being designed around Ferroxcube magnetic cores. The unique advantages of Ferroxcube are particularly marked in transformers required to handle up to 2 kilowatts of power in the frequency range from 2 kilocycles to 2 megacycles.

Ferroxcube-cored transformers are being used successfully in applications as diverse as ultrasonic power generators and rectifier power packs operating from an aircraft's normal a-c supply. In the latter application, the low leakage field of Ferroxcube eliminates the need for external shielding — for further reduction in transformer size and weight.

Ferroxcube cores are designed and produced to specifications. Our engineering department offers a complete, prompt service to assist in the design of Ferroxcube cores for specific applications. Your inquiry will receive immediate attention.

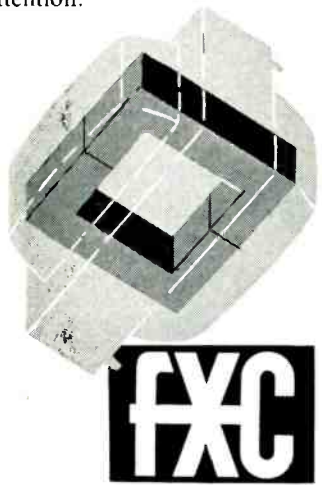

**FERROXCUBE CORPORATION OF AMERICA**

A Joint Affiliate of Sprague Electric Co. and Philips Industries  
Managed by Sprague

35 EAST BRIDGE STREET • SAUGERTIES, NEW YORK

Want more information? Use post card on last page.

in color when freshly husked. Over a period of about two weeks, this shell darkens until it looks like a mature nut.

If, however, the nut is opened and the meat is used, it will have poor keeping qualities compared with the mature nut, is more easily susceptible to becoming rancid, which will have naturally a considerable effect on the quality of the subsequent product. The moisture content of an immature nut will be 53 percent or higher. This also results in a greater loss of weight during this desiccation process and a higher cost of the finished product.

The method of payment of those who pick and transport the nuts is such as to provide no incentive to favor discrimination of proper choice. The desiccated coconut mills have no control over the land owners or the pickers of the nuts; they buy them on the open market and are forced to do their own grading. The rejected nuts are taken back by the owners and used to make copra, another even more important product of the coconut industry. The monetary return they get is only slightly less than for desiccation purposes. The percentage of rejects is from 3 to 25 percent.

### Speed Required

The coconut mill under discussion handles an average of 600,000 nuts a day and turns out several hundred tons of finished product per day.

Various schemes have been tried and discarded for grading. A fresh green nut will sink, and a mature nut will float (husked nuts) so it seems that a method could be worked out even though something more accurate than merely floating in water is required. However this is a slow method.

The immature nut, kept for about two weeks, will change its specific gravity and will behave like a freshly husked mature nut, as well as change its color. There would be no protection against the unscrupulous seller who would keep husked immature nuts for a proper length of time.

An x-ray method has been tried and discarded because the shell is

## ..... for the finest MODULAR INSTRUMENT ENCLOSURE SYSTEM

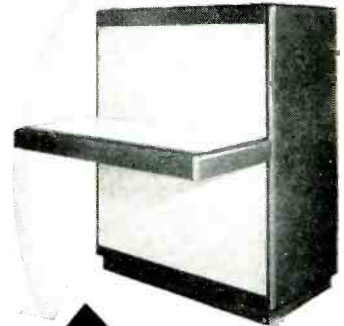

*Amco* **save time!  
save money!**

### COMPARE

- True custom built appearance
- Complete modular versatility
- Multi-width exterior surfaces independent of frames

SEND FOR OUR NEW CATALOG NO. 101

Look for us at the N.E.C.  
Booth No. 208

AMCO ENGINEERING COMPANY  
7335 Ainslie St. Chicago 31, Ill.

## INCREASED INSULATION BETTER CONNECTIONS

### JONES BARRIER Terminal Strips

Leakage path is increased—direct shorts from frayed terminal wires prevented by bakelite barriers placed between terminals. Binder head screws and terminals brass, nickel plated. Insulation, molded bakelite.



No. 2-142



No. 2-142-3/4 W



No. 2-142-Y

Shown: Screw Terminals—Screw and Solder Terminals—Screw Terminal above, Panel with Solder Terminal below. For every need.

Six series meet every requirement: No. 140, 5-40 screws; No. 141, 6-32 screws; No. 142, 8-32 screws; No. 150, 10-32 screws; No. 151, 12-32 screws; No. 152, 1/4-28 screws.

Catalog No. 21 lists complete line.

**Jones** **HOWARD B. JONES DIVISION**  
CINCH MANUFACTURING CORPORATION  
CHICAGO 24, ILLINOIS  
SUBSIDIARY OF UNITED-CARR FASTENER CORP.

Want more information? Use post card on last page.

much denser than the meat. However, the immature meat is slightly less opaque than the mature meat.

One method used with only fair success is thumping the nut by one's knuckles. An experienced grader can determine the extremes of quality, but, since the greater portion of the nuts lie both above and below the borderline, there is no way of distinguishing about 60 percent of the nuts.

An application of the radar-sonar principle of echo response might be the solution. We would like to contact any firms that are interested in this field or who might be doing investigative work already, or who have equipment which could be applied. The operators of these factories believe that a substantial improvement in quality of their product, as well as a reduction in operating expenses, could be effected even by the employment of a relatively expensive machine due to the large volume of production.

We can arrange to forward by air express samples of coconuts upon which tests could be performed. It is necessary that nuts be air expressed, as considerable error may occur due to the relatively rapid changes occurring in transit that may affect the accuracy of reading of nuts and because nuts from the Philippines might differ from those of other regions.

EARL HORNSBOSTEL  
President & General Manager  
Radio Electronic Headquarters, Inc.  
Manila, P. I.

Editor's Note: Here's a nice problem in which electronic engineers can really set their teeth.

The thought of measurement of dielectric quality occurs because of the difference in a liquid content. Or, day-dreaming, a low-power dielectric heater that could discriminate its loading, reject immature nuts that load heavily due to higher moisture content, yet not heat the meat of the mature nut unduly.

### Gravity and Other Factors

DEAR SIRs:

COMMENTS of Mr. Tewksbury on the nature of gravity (ELECTRONICS, page 372, July 1956) deal with a



also  
150 &  
450 MC  
Omnidirectional  
Arrays—  
gains to 10db.

**PARABOLAS**  
890-960 MC  
450-470 MC  
**MULTI-ELEMENT  
GRID CONSTRUCTION\***

*light weight, low windage, rugged HELIARC welded aluminum  
open construction permits lighter, lower cost towers  
Parabolas up to 15' diameter  
retain electrical properties of solid spun dish up to 1000 MC*

\* patent applied for

# MARK PRODUCTS

6412 W. LINCOLN AVE.

MORTON GROVE, ILLINOIS • PHONE ORchard 5-4999

**free** send for the  
most widely used  
**ELECTRONIC SUPPLY GUIDE**

**ALLIED'S  
COMPLETE 356-PAGE  
1957 CATALOG**

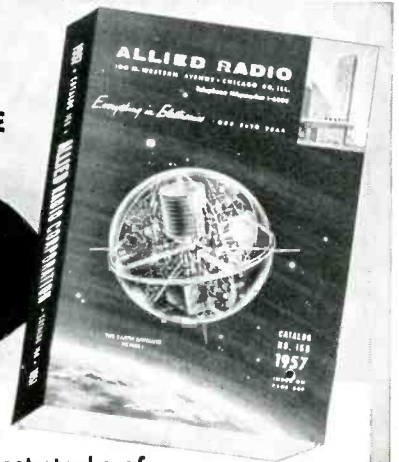

We specialize in  
Electronic  
Equipment Supply  
for Research,  
Development,  
Maintenance  
and Production

**COMPLETE EXPERT  
INDUSTRIAL SERVICE**



One complete  
dependable source  
for Everything  
in Electronics

Our 36th Year

**your buying guide  
to the world's largest stocks of  
ELECTRONIC SUPPLIES FOR INDUSTRY**

Simplify and speed your purchasing of electronic supplies and equipment: send your orders to ALLIED—the reliable one-supply-source for *all* your electronic needs. We make fastest shipment from the world's largest stocks of electron tubes (all types and makes), transistors, test instruments, audio equipment, electronic parts (transformers, capacitors, controls, etc.), and accessories—*everything* for industrial and communications application. Our expert Industrial supply service saves you time, money and effort. Send today for your **FREE** copy of the 1957 ALLIED Catalog—your *complete* Buying Guide to quality Electronic Supplies for Industrial and Broadcast use.

**ALLIED RADIO**

100 N. Western Ave., Dept. 11-K-6  
Chicago 80, Illinois

Send for  
**FREE  
Catalog**



# LONCO

## PRINTED CIRCUIT CHEMICALS *mean:*

**Faster Production  
... Minimum Rejects  
..... Better Circuits**

Choose Lonco, the Most Complete Line of Soldering and Fluxing Chemicals Available, for:

### 1 Pre-Soldering Protection

Coat with Sealbrite No. 230-10. This thin, clear liquid coating provides 3 important advantages over other products of this type: 1) longer protection against oxides, carbonates and hydrates; 2) greatly increased solderability; 3) instant displacement of water and moisture from metal surfaces.

### 2 Masking

Coat with PC No. 33 Solder Resist. This is an extremely easy to apply masking coating which can be silk screened onto the circuit panel, if desired. It effectively minimizes bridging, saves solder and produces a neater circuit. Solder Resist has a short time low temperature cure of 20 to 30 minutes and resists high solder pot temperatures up to 650°F. It may be used as received or thinned to any working viscosity.

### 3 Fluxing and Soldering

Spray, dip or roller coat Fluxcote 21XR onto the circuit panel. This promotes quick and quiet soldering — whether area, spot or other automatic tinning or soldering systems are used. The bright, varnish-like residue is completely dry and tack-free and acts as a protective coating against leakage or breakdown.

If insulating fluxes are preferred, Lonco Insulating Rosin Flux or fast-taking Rosin Flux No. 160 are recommended. Special fluxes are also available for individual applications.

### 4 After Soldering

Use Lonco Flux Removers to insure fastest possible removal of flux residue and complete safety to personnel, the electrical circuit itself, plastic parts, color coding, decals, etc. Four types are available in varying degrees of solvency. Special removers can be furnished to order.

All Lonco Flux Removers are rated as non-flammable or as safety solvents... toxicity is always in the least toxic range of commercial solvents.

Get complete information and literature now. Request technical bulletin, *Soldering of Printed Circuits*.



**LONDON CHEMICAL  
COMPANY, Inc.**

1535 North 31st Avenue  
Melrose Park, Illinois

Want more information? Use post card on last page.

BACK TALK

(continued)

serious problem of extreme importance in the whole realm of science and technology.

The acceleration of gravity is one of the most important constants of Nature. It is so important that the National Bureau of Standards has considered trying to redetermine the mathematical value of the pull of gravity. The presently accepted international value is 32.174 feet per second for every second. This is to an accuracy of one part in 50 million. But scientists are not satisfied with this accuracy; it is too coarse for nuclear problems.

I am inclined to agree with Mr. Tewksbury's view that gravity may be the resultant of forces within the observed masses.

Newton's fundamental law assumes all the mass concentrated at the center of a body. There may exist anomalies in the internal structure. Because of this, at times, inaccurate answers are deduced.

Consider the earth, for instance. If it were a true sphere, geophysicists would have an easy time figuring things out. However, the rotation of a partially elastic earth flattens it at the poles and bulges it at the equator; like any elastic sphere would when rotated. The ellipsoid shape causes different values of gravity, according to geographical position, gravity pull increasing toward the poles.

The variations are serious enough to require correction factors for athletic records in Olympic Games. A smaller force of gravity favors the athlete on latitudes near the equator.

The gravity pull is also affected by what the geodesist calls isostatic equilibrium. This mouthful is nothing more than what the engineer calls even distribution of weight in a flywheel. The earth is also like an immense flywheel with peripheral speed of approximately one thousand miles per hour. It, too, must have its weight evenly distributed, or shake itself to pieces.

Like all wonders in Nature, the earth's crust has been formed so that under heavy, massive moun-

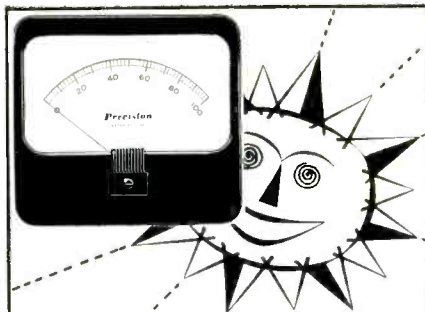

THERE IS  
SOMETHING NEW  
UNDER THE SUN!

Panel meters at SENSIBLE PRICES! PRECISION METERS are Accurate - Rugged - Dependable, designed for Lifetime Service. Latest Engineering Methods and Production allow us to maintain absolute Quality Control and ship orders Promptly. Give us your meter requirements and PRECISION METER will provide the answer.

Write today for FREE CATALOG and be convinced!

**PRECISION METER CO., Inc.**  
126 Greenpoint Ave. • Brooklyn 22, N. Y.

## Designed for Aircraft, Industrial and Scientific Instrumentation



### Beattie VARITRON Electric Camera - Model D

- Radar Scope recording
- Oscilloscope recording
- Panel instrumentation
- Aerial spotting
- Security surveillance
- Personnel survey
- Identification
- Manometer panel recording
- Test surveillance
- Inspection records

Here is the versatile data recording camera that saves you time and labor, and gives you a permanent, accurate record. Rugged construction... interchangeable lenses... available in different camera body lengths for special applications.

Write for complete detailed literature today.

*Photographic  
Products Inc.*

1000 North Olive St. • Anaheim, California

Want more information? Use post card on last page.

**COMPLETE  
BURNER  
CATALOG**



AGF, builders of gas burners and equipment for over 77 years, offers this first complete catalog of technical data on air-gas and oxygen-gas burner equipment.

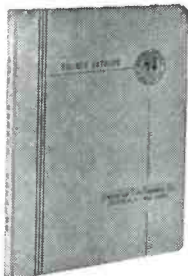

- Sharp Flame, Fish Tail, Blast and Oxygen-Hydrogen Burners.
- Blowpipes, Hand Torches and Mixing Equipment.
- Flow Meters, Fire Checks and Ball Joints.
- Many accessories and much technical data.

All of the above are available in the new AGF Burner Catalog, promptly mailed to you upon written request on your company's letterhead.



**AMERICAN GAS FURNACE CO.**

130 Spring St. Elizabeth 4, N. J.

**MILFORD**



TUBULAR RIVETS

SPLIT RIVETS

COLD-FORMED SPECIALTIES

RIVET-SETTING MACHINES



**THE  
MILFORD  
RIVET & MACHINE CO.**

**PLANTS:** MILFORD, CONNECTICUT  
HATBORO, PENNSYLVANIA • ELYRIA, OHIO  
AURORA, ILLINOIS • NORWALK, CALIFORNIA

**TRANSFORMERS FOR  
ELECTRONICALLY REGULATED POWER SUPPLIES**

*Now... over the counter*

Avoid delay in making your breadboards,  
no waiting for a special when a

**STERLING 2K SERIES**

transformer will meet your requirements exactly. Stock STERLING 2K units are available for supplies from 100 milliamperes at 100 volts to 400 milliamperes at 300 volts



Technical specifications on a typical unit of this family of transformers for use in a 300 volt 200 milliamperes dc regulated power supply with 90 to 130 V AC input:

**ST2010**

Primary:  
115 Volts AC, 50 to 1000 cps

Secondaries:	
570-0-570V	240 ma*
5.0V	3 A
6.3V	3 A
6.3V	1.2A
6.3VCT	6 A

\*Note 40 ma provided

Size: 5 1/8 x 4 5/8 x 5 1/2 H  
Mtg. Centers: 3 1/2 x 3 1/2  
Weight 15 lbs.  
Associated Choke: ST2009  
4 Henries at 240 ma.

**Each 2K transformer provides:**

- PLATE VOLTAGE ALLOWANCE FOR PASS TUBE..... VOLTAGE DROP
  - RECTIFIER FILAMENT POWER.....
  - PASS TUBE FILAMENT POWER.....
  - REGULATOR CIRCUIT FILAMENT POWER.....
  - AUXILIARY FILAMENT POWER FOR OTHER CIRCUIT REQUIREMENTS.....
  - REGULATOR CIRCUIT PLATE POWER.....
  - APPLICATION BULLETIN WITH EACH UNIT
- Military versions of each of these units is also available. Technical data on the complete line is available on request.

*SAMPLES? SPECIALS? SHORT RUNS?*

The 2K series is only one of the many types we make. We specialize in custom-built transformers to your specifications. Let our engineering staff help solve all your transformer problems.

Samples delivered in 1 to 3 weeks.



299 North 7th St., Brooklyn 11, N. Y.  
STagg 2-4200



DE MORNAY-BONARDI

first in  
ultramicrowave  
equipment

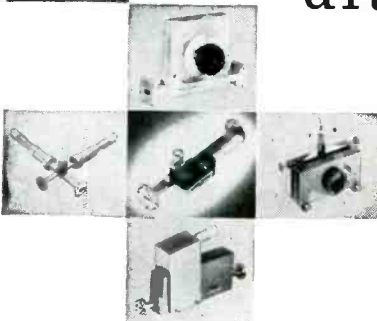

A complete line of research instruments covering frequencies up to 90,000 mc... proved in laboratories the country over.



DE MORNAY-BONARDI • 780 SOUTH ARROYO PARKWAY • PASADENA, CALIFORNIA

**COSMIC  
CONDENSERS**  
ELECTROLYTIC & PAPER TUBULAR  
For A.C., D.C. Sets - Radio, Television  
Phonographs, etc.

CONDENSER  
SPECIALISTS  
SINCE 1923

STABILITY  
AND  
RELIABILITY

**COSMIC CONDENSER CO.**  
853 WHITTIER ST., BRONX, N. Y.  
Phone: LUdlow 9-3360

# MARKEM<sup>®</sup> MACHINES

Solve "IN-PLANT" PRINTING PROBLEMS  
- FASTER - NEATER - AT LOWER COST

## COLOR BANDING WIRE LEAD COMPONENTS

The Markem 69A Machine semi-automatically applies up to six color bands to wire lead components such as resistors and condensers. Band width and color changes are easily made. Automatically feeds and ejects; bands about 50 objects per minute. The 69A will also mark cylindrical objects with complete label detail, in one or two colors.

Other Markem machines available for marking electrical parts and products of all sizes and shapes. Write for detailed information.

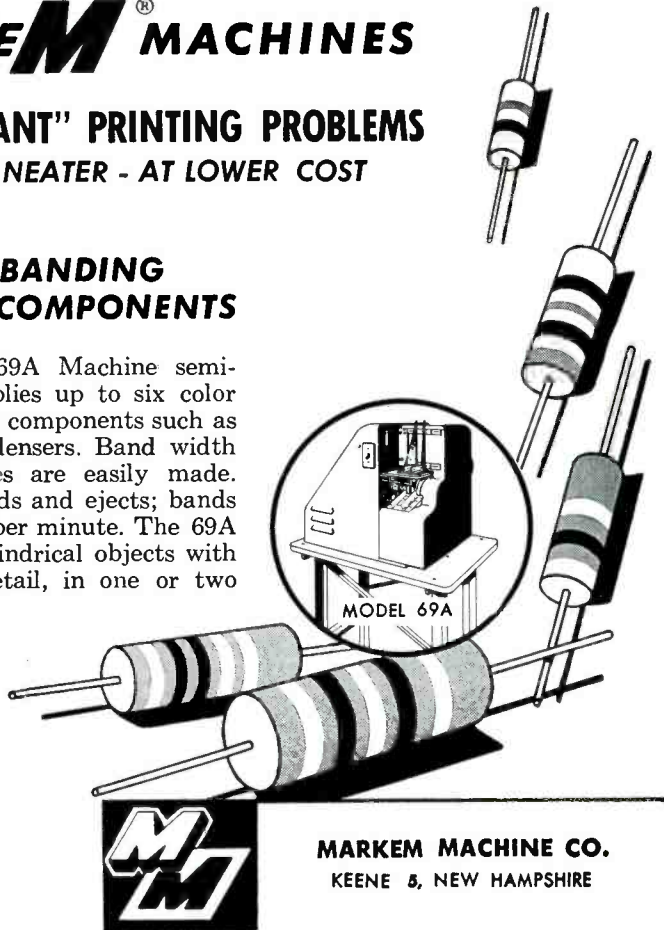

BACK TALK

(continued)

tains there is a deficiency of weight, and under relatively light ocean basins there is an excess of weight. This internal structure gives the earth its dynamic balance and saves it from destructive vibration; but it also puts in gravitational anomalies which plague the geophysicist.

Another factor is the centrifugal force of the earth's rotation. It exerts a small counter action which is maximum at the equator and diminishes to zero at the poles.

There is also the gravitational pull of the sun, varying from day to day, because the earth's solar orbit is not a true circle. To complete the trip around the sun in one year (375,000,000 miles) the earth must hurry along with a speed of approximately sixty thousand miles per hour. This adds another centrifugal force to the experimenter and his instruments, all of which must stay with the earth wherever she goes.

These observations bring out the staggering proportions of the problem of refining the mathematical value of the pull of gravity. It is one of the greatest challenges of science to mankind.

JOHN J. RIVERA  
Senior Designer  
Federal Telecommunications Lab.  
Nutley, New Jersey

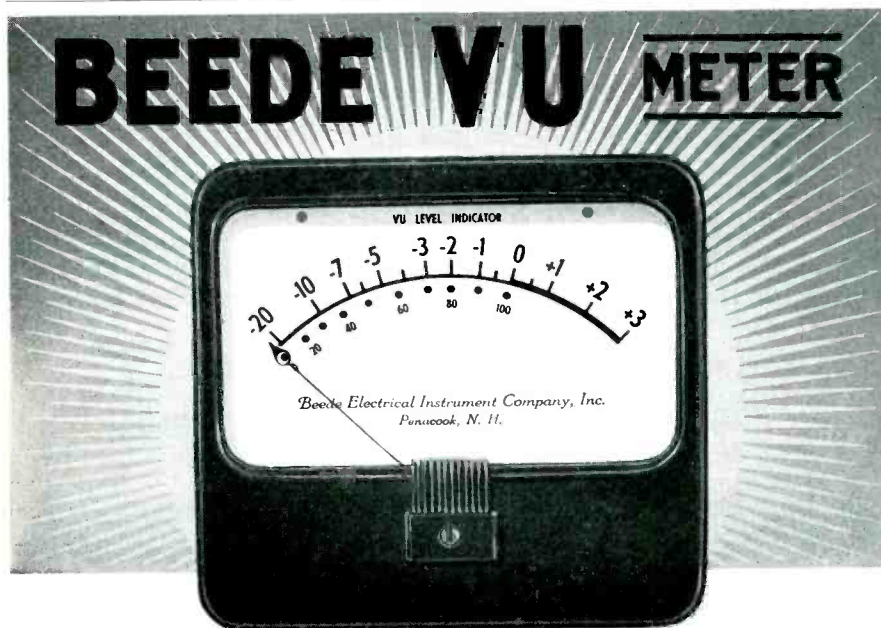

IN THE NORMAL EXPANSION AND DEVELOPMENT OF THE BEEDE INSTRUMENT LINE THE **VU** METER BECOMES ANOTHER PROMINENT MEMBER. THE MOST POPULAR MODEL IS IN THE **16** STYLE.

*Inquiries as to modifications of  
this meter are always welcome*

**BEEDE** ELECTRICAL INSTRUMENT CO., INC.  
PENACOOK, N. H.

## Gravity Radiation Concept

DEAR SIRS:

WAS much interested in the gravity theory discussion.

As a curbside physicist, an interesting factor in gravitation theory is that it is not necessary to use an attraction hypothesis. Many of the same properties can be worked out on the basis of radiation and absorption theory.

Mass absorbs the radiation and its momentum, and shields other masses in so doing. This can lead to the inverse square law and to small-distance effects. The nature of the small-distance effects can be selected by suitable choice of absorption law.

Would be an interesting subject for some Ph D thesis. I considered it once but ended up with a



# PROFESSIONAL SERVICES

Consulting—Patents—Design—Development—Measurement

in

Radio, Audio, Industrial Electronic Appliances

## BRIGGS ASSOCIATES, INC.

*Engineering Services*

ELECTRONICS MECHANICAL

Development — Manufacturing — Consulting  
Special Machines — Instrumentation — Automation  
Electron Tube Design, Materials, Reliability

10 DeKalb St. Broadway 9-2120 Norristown, Pa.

## GENERAL ATRONICS CORPORATION

David E. Sunstein, George J. Laurent  
Dr. Robert W. Roop, Bernard D. Steinberg

Consulting Services—Electronics, Acoustics, Technical  
Planning Operations Research for Industrial  
Consumer and Government Products.

125 City Line Av. Bala-Cynwyd, Pa. (Phila. suburb)  
MOhawk 4-8090

## NIAGARA ELECTRON LABORATORIES

CONSULTATION - DESIGN - CONSTRUCTION  
MFG. THE THERMOCAP RELAY

Specializing in solution of problems of electronic  
and electro-physical instrumentation for the research  
or analytical laboratory. Industrial plant problems  
also invited.

Andover, New York Cable Address: NITRONLAB

## BART LABORATORIES

Division of BART MANUFACTURING CORP.

Consultation and Manufacturing Services on precision  
electro-forming and precious metal plating  
since 1918.

227 Main Street Belleville 9, N. J.  
PLYmouth 9-0200

## HANSON-GORRILL-BRIAN INC.

*Product & Mfg. Development*

ELECTRICAL - ELECTRONIC  
HYDRAULIC - MECHANICAL

One Continental Hill Glen Cove, N. Y.  
Glen Cove 4-7300

## PICARD & BURNS, INC.

*Consulting Electronic Engineers*

Analysis and Evaluation  
of Radio Systems

Research Development and Production  
of Special Electronic Equipment

240 Highland Ave. Needham 94, Mass.

## CROSBY LABORATORIES, INC.

*Murray G. Crosby & Staff*

Radio - Electronics  
Research Development & Manufacturing  
Communication, FM & TV

Robbins Lane, Hicksville, N. Y.  
WElls 1-3191

## THE KULJIAN CORPORATION

*ELECTRONICS DIVISION*

*Consulting Electronic Engineers*

Research Development, Production of  
Automatic Controls — Special Instrumentation  
1200 No. Broad St., Philadelphia 21, Pa.  
Stevenson 2-9000

## ALBERT PREISMAN

*Consulting Engineer*

Television, Pulse Techniques, Video  
Amplifiers, Patent technical consultation.

616 St. Andrews Lane, Silver Spring, Maryland.  
JUmpier 5-6307

## DELAWARE PRODUCTS CO.

Analog Voltage to Digital Conversion  
Digital Voltage Recording Systems

*Design-Development-Manufacturing*

300 Broadway Camden 3, N. J.

## McDOWELL ELECTRONICS, INC.

Soft soldering of  
metallized ceramics by  
induction heating.

Consulting—Development—Manufacturing  
P. O. Box 342, Metuchen, N. J.  
Liberty 8-9109

## TELECHROME, INC.

*Electronic Design Specialists*

COLOR TELEVISION EQUIPMENT

Flying Spot Scanners, Color Synthesizers, Keyers,  
Monitors, Oscilloscopes and Related Apparatus  
J. R. Popkin-Chirman, Pres. & Ch. Engr.  
88 Merriek Rd. Anstyville, L. I., N. Y.

## ELECTRONIC RESEARCH ASSOCIATES, INC.

"TRANSISTORIZE" YOUR PRODUCT!  
Complete Service in consulting, research, develop-  
ment, and production on Transistor circuitry, prod-  
ucts and instrumentation.

67 East Centre Street Nutley, N. J.  
NUTley 2-5410

## Measurements Corporation

*Research & Manufacturing Engineers*

HARRY W. HOUCK MARTIAL A. HONNELL  
G. ROBT. MEZGER

Specialists in the Design and  
Development of Electronic Test Instruments  
Boonton, New Jersey

## WHEELER LABORATORIES, INC.

Radio and Electronics

Consulting — Research — Development

R-F Circuits — Lines — Antennas

Microwave Components—Test Equipment

Harold A. Wheeler and Engineering Staff

Great Neck, N. Y. HUInter 2-7876

## ERCO RADIO LABORATORIES, INC.

*Radio Communications Equipment*

Engineering - Design - Development - Production

Our 27th Year in Air to Ground  
Communications and Radio Beacons

Garden City • Long Island • New York

## MINOT INFORMATIC DEVICES

AUTOMATIC RECOGNITION OF  
SHAPES, PATTERNS & INFORMATION  
RESEARCH - INVENTION - CONSULTING

on detection and interpretation of  
complicated forms, characteristics of  
materials, printed characters, etc.  
Otis N. Minot, 22 Eliot Rd., Lexington 73, Mass.  
Tel. VOLunteer 2-9465 or - 3974

## YARDNEY LABORATORIES

*Research-Design-Development*

Electro-Chemical Generators of Energy

40-46 Leonard Street Worth 6-3100  
New York 13, N. Y.

THE  
CONSULTING  
ENGINEER

"By reason of special training, wide experience and tested ability, coupled with professional integrity, the consulting engineer brings to his client detached engineer and economic advice that rises above local limitations and encompasses the availability of all modern developments in the fields where he practices as an expert. His services, which do not replace but supplement and broaden those of regularly employed personnel, are justified on the ground that he saves his client more than he costs him."

# PRECISION ATTENUATION to 3000 mc!

## SINGLE "in-the-line" ATTENUATOR PADS and 50 ohm COAXIAL TERMINATIONS



PROTECTED UNDER STODDART PATENTS

This new group of pads and terminations features the popular Types C and N connectors, and permits any conceivable combination of the two styles.

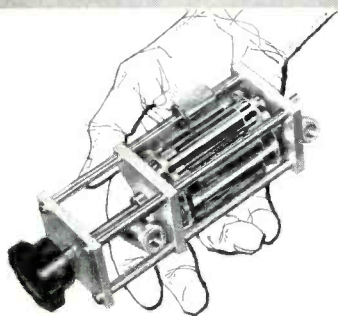

PROTECTED UNDER STODDART PATENTS

six-position

## TURRET ATTENUATOR

- Frequency Range: dc to 3000 mc.
- Characteristic Impedance: 50 ohms.
- Available Attenuation: Any value from 1 db to 60 db.
- Accuracy:  $\pm 0.5$  db.
- Power Rating: One watt sine wave power dissipation.

# STODDART

Aircraft Radio Co., Inc.  
6644-A SANTA MONICA BLVD.  
HOLLYWOOD 38, CALIF. • HO 4-9294

BACK TALK

(continued)

less ambitious alternative.

GEORGE F. FORBES  
Pacoima, California

## Useful Gage

DEAR SIRs:

WITH reference to your article "Noncontacting Gages for Non-ferrous Metals," (March '56, p 171) you may be interested to learn that equipment operating on the same principles as that described in your article has been made commercially for several years by Institute Dr. Foerster, Reutlingen, Germany.

Due to a thorough theoretical analysis of the basic principles involved and the results of practical field experience, the German equipment is somewhat more highly developed than that described in your article.

A resume of the theoretical analysis may be found in the following paper: F. Foerster, "Die beruehrungsfreie Messung der Dicke und Leitfaehigkeit von metallischen Oberflaechenschichten, Folien und Blechen", *Zeitschrift fuer Metallkunde*, Volume 45, 1954, No. 4, pages 197-199.

B. H. ROBINSON  
Research Engineer  
Magnaflux Corporation  
Chicago, Illinois

DEAR SIRs:

THIS is in reply to your letter and that of Mr. Robinson of Magnaflux Corporation. We have obtained a copy of the translation of the article by Dr. Foerster.

There seems to be no basic difference of opinion between Dr. Foerster's work and our work. The general approach and explanation is slightly different but the results come out virtually identical.

We have a number of these units in the field and they work very nicely. It may interest you to know we had one of these units in Europe for over five years.

We have had a number of requests for further details from people who are building units as a result of our article. You will probably take this as an indication, as I do, that your publication is fulfilling one of its objectives.

R. B. COLTEN  
Process Development Section  
General Motors Corporation  
Detroit, Michigan

# THE RIGHT LOCATION for your operation



OVER  
350

COMMUNITIES TO CHOOSE FROM

Address  
S. P. Vecker, Vice President  
Area Development Dept.

## CAROLINA POWER & LIGHT COMPANY

RALEIGH / NORTH CAROLINA

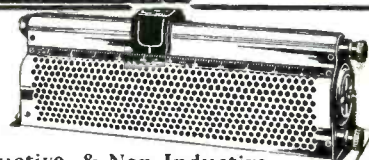

Inductive & Non-Inductive  
Rheostats & Resistors  
Toroidal Coil Winding Mach.



Taping Machines  
Winding Machines

REX RHEOSTAT CO.  
BALDWIN, SO. L. I. N. Y.

## MOISTUROMETER

Model 910 reads moisture percentage of powders, dehydrated foods, soils and other granulated materials directly.

Transistorized. Very accurate. Dependable. Portable.

Only \$75.00, F.O.B. Factory.

HENRY FRANCIS PARKS LABORATORY  
104 S.E. 57th Ave. Portland 15, Oregon

## MICA

India • Brazil

BLOCKS • FILMS • SPLITTINGS

All Grades & Qualities—Warehouse Stocks  
New York—Prompt Forward Shipments

Phone: Worth 4-4192 or write

ASSOCIATED COMMODITY CORPORATION  
Woolworth Bldg., New York 7, N. Y.



## MANUFACTURERS' REPRESENTATIVES

## MARYLAND

### MACLEN CORPORATION

Manufacturers Representative  
8616 Georgia Ave., Silver Spring, Md.  
Electronic Equipment

Territory:		Government
Pennsylvania	New Jersey	
Delaware	Maryland	and
Virginia	W. Virginia	Industry
District of Columbia		

# EMPLOYMENT OPPORTUNITIES

The Advertisements in this section include all employment opportunities—executive, management, technical, selling, office, skilled, manual, etc.



Positions Vacant  
Positions Wanted  
Part Time Work

Civil Service Opportunities  
Selling Opportunities Wanted  
Selling Opportunities Offered

Employment Agencies  
Employment Services  
Labor Bureaus

DISPLAYED

---RATES---

UNDISPLAYED

The advertising rate is \$21.50 per inch for all advertising appearing on other than a contract basis. Contract rates quoted on request.  
An advertising inch is measured  $\frac{3}{8}$ " vertically on a column—3 columns—30 inches to a page.  
Subject to Agency Commission.

\$2.10 per line, minimum 3 lines. To figure advance payment count 5 average words as a line.  
Box Numbers—counts as 1 line.  
Position Wanted ads are  $\frac{1}{2}$  of above rate.  
Discount of 10% if full payment is made in advance for 4 consecutive insertions.  
Not subject to Agency Commission.

Send NEW ADS or inquiries to Classified Advertising Division of ELECTRONICS, P.O. Box 12, N. Y. 36, N. Y., for November issue closing October 2nd.

## EDWARDS

EMPLOYMENT AGENCIES, INC.  
EXECUTIVES—ENGINEERS  
73 Warren St., N.Y. 17, N.Y. • BA 7-3672  
ELECTRONIC AND MECHANICAL ENGINEERS for positions as directors, scientists, physicists, staff, project, departmental heads, designers  
for: guided missiles • radar  
analog computers • tubes  
field engineering • pulse  
servomechanism • antennas  
communications • packaging  
transformers • TV and radio  
transistors • audio systems  
• instrumentation •  
microwave research & development  
Discreet service. Hundreds of client companies from coast to coast. Mostly fee-paid positions. Send resumes. Confidential.

REPLIES (Box No.): Address to office nearest you  
c/o This publication Classified Adv. Div.  
NEW YORK: P. O. Box 12 (36)  
CHICAGO: 520 N. Michigan Ave. (11)  
SAN FRANCISCO: 68 Post St. (4)  
LOS ANGELES: 1125 W. 6th St. (17)

### SELLING OPPORTUNITIES OFFERED

Manufacturer's representative—E.E. degree, industrial, for quality pulse transformer line. All territories open. RW-2882, Electronics.

Sales Representative Wanted to sell vinyl lacing cord to manufacturers. Our lacing cord approved and specified for Army Navy contracts. Superior to other types of lacing. Price now reduced to competitive levels. Liberal commissions. Kenmore Sales Company, Industrial Park, Lowell, Massachusetts.

### POSITIONS WANTED

Development Engineer, 31, single, Korean Vet., available March, 1957, desires position with very small company or self-supporting research lab only. Experienced in advanced physics. Media: Industrial Controls, Magnetic propulsion and networks, Electronic supplements (Motion Picture Techniques), Galvanic Logistics. World-wide travel, bilingual. Nat'lzd U. S. Citizen. PW-2881, Electronics.

Successful operations executive: Graduate Engineer, strong talent and practical ability in administering broad programs. Capacity for planning, organizing, supervising. Imaginative in dealing with people, equipment and facilities. PW-2824, Electronics.

Former Chief Engineer: Young, aggressive, directed research and development of Electronic and Electro Mechanical equipments under Government contracts. Technical planning and promotion, knows latest technical trends and techniques. Instrumental in motivating unsolicited proposals. Heavy sales experience in direct contacts with military and commercial engineering groups. Seeks challenging position or opportunity. PW-2922, Electronics.

### SELLING OPPORTUNITY WANTED

Representative for 8 years Phila.—Balto.—Wash.—with many contacts in Electronic field desires additional companies. RA-2983, Electronics.

Personnel Managers—Need experienced Engineers and Technicians? We offer a booklet especially prepared to help you solve this problem. Write for your "free" copy of "Reservoir of Engineers and Technical Men." Classified Adv. Div.—Electronics, P.O. Box 12, New York 36, N. Y.

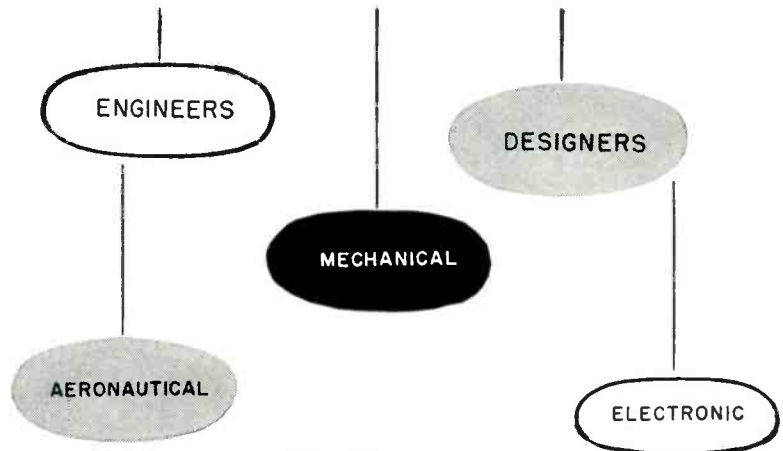

Provides MIDWEST Opportunities for Experienced Engineers

In South Bend, hundreds of professional people have found a community adequately satisfying for a highly educated way of life. Notre Dame is an excellent center for technical, graduate study, as well as affording cultural opportunities.

Immediate openings available in research, design, test and development:

AIRCRAFT JET FUEL SYSTEMS



Electro-Mechanical Design  
Magnetic Amplifiers  
Nuclear Control Applications  
Rocket Circuitry  
Servo-Mechanisms  
Systems Evaluation  
Thermo-dynamics  
Transistorization  
Vibration Analysis

AIRCRAFT LANDING GEAR



Computer Applications  
Heat Transfer  
Stress Analysis  
Structure  
Systems and Component Design or Testing

AUTOMOTIVE COMPONENTS



Conventional Brakes  
Hydraulic Systems  
Mechanical Design and Test  
Power Brake Research  
Power Steering

If you are interested in any of these engineering projects, send a summary of education and experience to:

Technical Employment,  
Department C-3  
BENDIX PRODUCTS DIVISION OF  
BENDIX AVIATION CORPORATION  
401 Bendix Drive  
South Bend, Indiana

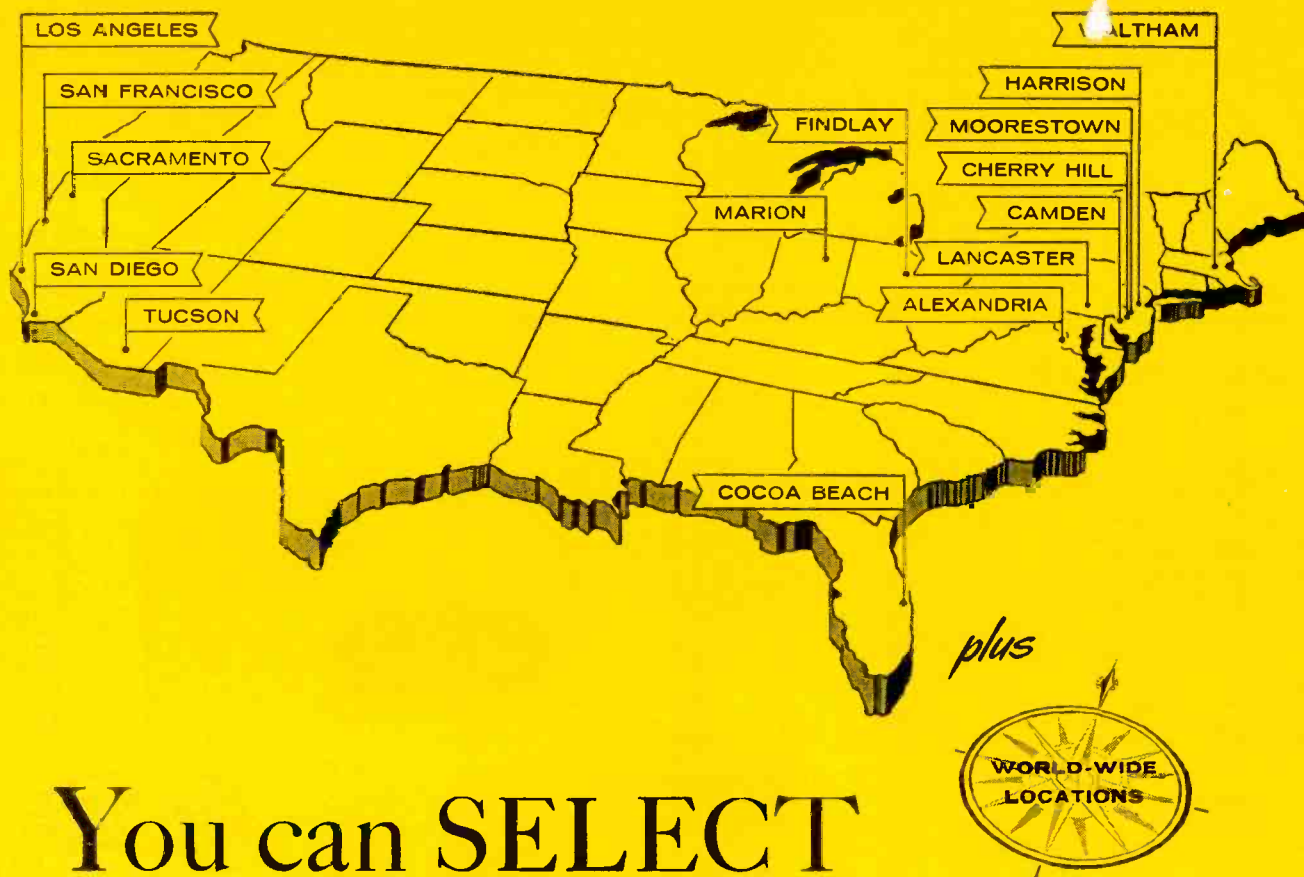

# You can SELECT at RCA!

**... New Opportunities ... 17 + Locations ... One Best For You And Your Family**

**Can anyone but RCA offer you  
a choice of locations like this?**

At Camden, Moorestown or Cherry Hill, you enjoy cultural advantages of Greater Philadelphia, live at moderate cost in pleasant suburban communities. Waltham offers at-home opportunities for New England engineers. Four ideal West Coast locations. Harrison borders on Greater New York. Lancaster, Marion and Findlay have small-town advantages. There's pleasant year-round outdoor living in Cocoa Beach, on Florida's central east coast. RCA Service Company and International Division assignments include ideal locations in the United States, and wherever RCA electronic equipments are installed and serviced throughout the world.

**Individual Recognition—**

RCA organizes engineering activities into groups small enough to allow broadest scope for your individual accomplishment. The average group has just 11 engineers. Yet, in all activities, you are supported by the entire facilities and engineering resources of RCA.

**Salaries—**

RCA engineering salaries average measurably higher than other companies' in the field. Intermediate engineers, \$5000-\$8500; senior engineers, \$8500-\$15,000; staff and supervisory salaries open.

**Advancement—**

Scheduled, objective appraisal of your work speeds promotion. Professional and financial progress is just as sure as your achievements make it.

**Professional Status—**

RCA bases world leadership in electronics on the abilities of exceptional men at every organizational level. Many have notable engineering and scientific reputations. You work in day-by-day association with men of this caliber.

**Benefits—**

There's a complete program at RCA. A very liberal Tuition Refund Plan. Company-paid life, sickness and accident, hospital-surgical insurance for you and your family. Modern retirement plan. Relocation expenses paid. Suggestion and patent awards.

# Now, Pinpoint Your Future

...Here are the Opportunities!  
...Here are the Locations!

FIELDS OF ENGINEERING ACTIVITY		MANAGERS	TYPE OF DEGREE AND YEARS OF EXPERIENCE PREFERRED													
			Electrical Engineers			Mechanical Engineers			Physical Science			Chemistry Ceramics Glass Technology Metallurgy				
			0-2	2-3	4-15	0-2	2-3	4-15	1-2	2-3	4-15	1-2	2-3	4-15		
<b>• SYSTEMS</b> (Integration of theory, equipments and environment to create and optimize major electronic concepts.)	<b>AVIATION ELECTRONICS • CONTROLS</b>			W	W							W	W			
	<b>DIGITAL DATA HANDLING DEVICES</b>	M	C	C	C			C	C			C	C			
	<b>MISSILE ELECTRONICS • RADAR</b>	M	W	M	W			M	W			M	W			
	<b>INERTIAL NAVIGATION</b>	W			W					W				W		
	<b>COMMUNICATIONS</b>				C									C		
<b>• DESIGN • DEVELOPMENT</b>																
<b>KINESCOPES (B &amp; W and COLOR), OSCILLOSCOPES</b> —Electron Optics—Instrumental Analysis—Solid States (Phosphors, High Temperature Phenomena, Photosensitive Materials and Glass to Metal Sealing)				L	L	L	L	L	L	L	L	L	L	L	L	
<b>RECEIVING TUBES</b> —Tube Design—Test and Application Engineering—Chemical and Physical Development—Methods and Process Engineering—Advanced Development				H	H	H		H	H			H	H		H	
<b>SEMI-CONDUCTORS</b> —Transistors—Semi-Conductor Devices—Materials				H	H	H	H	H	H	H	H	H	H	H	H	
<b>MICROWAVE TUBES</b> —Tube Development and Manufacture (Traveling Wave—Backward Wave—Magnetron)		H		H	H			H	H			H	H		H	
<b>GAS, POWER AND PHOTO TUBES</b> —Photosensitive Devices—Glass to Metal Sealing—UHF and VHF—Power				L	L	L	L	L	L	L	L	L	L	L	L	
<b>AVIATION ELECTRONICS</b> —Radar—Computers—Servo Mechanisms—Shock and Vibration—Circuitry—Remote Control—Heat Transfer—Sub-Miniaturization—Automatic Flight—Automation—Transistorization		W	C	W	W	W	W	W	W	W	W	W	W	W	W	
<b>COMPUTERS</b> —Systems—Advanced Development—Circuitry—Assembly Design—Mechanisms—Programming				C	C	C	C	C	C	C	C	C	C	C	C	
<b>RADAR</b> —Circuitry—Antenna Design—Servo Systems—Gear Trains—Intricate Mechanisms—Fire Control—Information Handling—Displays		M	C	M	M	M	M	M	M	M	M	M	M	M	M	
<b>COMMUNICATIONS</b> —Specialized Military Systems—Microwave—Aviation—Audio—Propagation Studies				C	C	C		C	C	C	C	C	C	C	C	
<b>MISSILE ELECTRONICS</b> —Systems Planning and Design—Radar—Fire Control—Shock Problems—Servo Mechanisms		M		M	M	M	M	M	M	M	M	M	M	M	M	
<b>COMPONENTS</b> —Transformers—Coils—TV Deflection Yokes (Color or Monochrome)—Resistors—Ferrites (Material and Parts)				C	C	C	C	Z	Z	C	C	C	C	C	Z	
<b>• SYSTEMS APPLICATION</b> (Evaluation and Planning—Design and Development—Modification—Specification)																
<b>MISSILE TEST INSTRUMENTATION</b> (Data Acquisition and Processing)—Radar—Telemetry—Timing—Communications—Optics—Computers		F		F	F	F	F	F	F	F	F	F	F	F	F	
<b>RADAR</b> —Airborne—Surface—Shipboard—Sona—Fire Control		F		F	F	F	F	F	F	F	F	F	F	F	F	
<b>COMMUNICATIONS</b> —Radio—HF—VHF—UHF—Microwave—Telephone—Teletype—Telegraph Terminal Equipment—Wave Propagation		F		F	F	F	F	F	F	F	F	F	F	F	F	
<b>• MACHINE DESIGN</b> Mechanical and Electrical—Automatic or Semi-Automatic Machines				L	L		L	L	L	C		L	L			

Locations: C—Camden, N.J. F—Ft. Collins, Colo. H—Harrison, N.J. I—International Div. L—Lancaster, Pa. M—Moorestown, N.J. S—RCA Service Co. (Cherry Hill, N.J.; Alexandria, Va.; Tucson, Ariz.; San Diego, Sacramento, San Francisco, Calif.; Foreign Assignments). W—Waltham, Mass. X—Los Angeles, Calif. Y—Marion, Ind. Z—Findlay, Ohio



Please send resume of education and experience, with location preferred, to:

Mr. John R. Weld, Employment Manager  
Dept. A-15K, Radio Corporation of America  
30 Rockefeller Plaza, New York 20, N.Y.

**RADIO CORPORATION of AMERICA**

Copyright 1956 Radio Corporation of America

# ENGINEERS

for immediate placement

**ELECTRICAL ENGINEERS  
MECHANICAL ENGINEERS  
ELECTRONIC ENGINEERS  
COMPUTER ENGINEERS  
SOLID-STATE PHYSICISTS**

## Engineering at NCR:

1. Immediate, permanent positions in Mechanical Engineering, Electrical Engineering and Physics Research Divisions.

2. Engineering project work in Adding Machines, Cash Registers, Accounting Machines, Computers and related Data Processing Equipment in Dayton, Los Angeles, and Ithaca, New York.

3. Opportunities in design, development, produc-

tion-engineering and packaging of mechanical, electronic, and electromechanical devices.

4. Some experience in development, design, and application of high-speed, light-weight mechanisms of the intermittent-motion type; or, experience in digital devices and components, is desirable, but not essential.

5. Ample training and indoctrination is available to all employees.

## As an NCR engineer you, with your family, will enjoy:

1. UNLIMITED OPPORTUNITY in the broad, ever-expanding field of Business Machine Engineering and Research.

2. AN EXCELLENT SALARY, plus exceptional benefits of lifetime value for you and your family.

3. A RECREATIONAL PROGRAM for year-round enjoyment of the entire family, including a new NCR Country Club with 36 holes of golf, and a 166-acre

employees' park for outings with swimming, boating, and supervised play for the children.

4. LIVING IN DAYTON . . . considered a clean, attractive, progressive city with outstanding school facilities.

5. YOUR WORK AT NCR with its friendly, family atmosphere, with its employee morale at a very high level, and with people who, like yourself, have decided to build their professional future with NCR.



**ACT AT ONCE** — Send résumé of your education, experience and geographic preference to:

**EMPLOYMENT DEPARTMENT, TECHNICAL PROCUREMENT SECTION 4**

**THE NATIONAL CASH REGISTER COMPANY  
Dayton 9, Ohio**

\* Trade-Mark—Reg. U. S. Pat. Off.

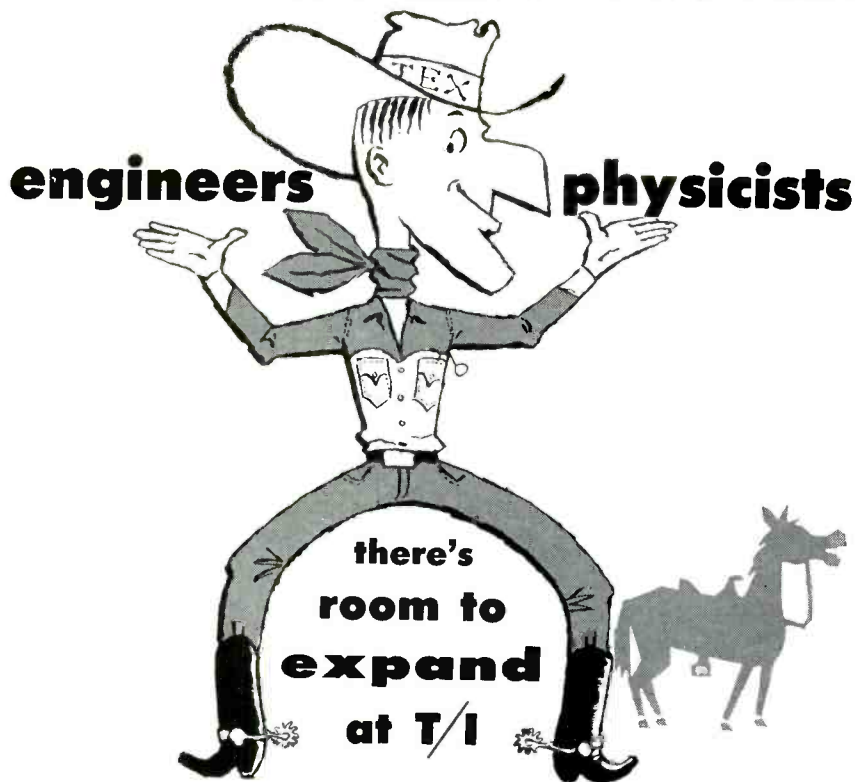

Texas Instruments expanding research and development programs have opened outstanding opportunities for physicists (solid state) and electronics engineers. TI offers you real chances for advancement in a rapidly-growing industry. Positions are now available in the following fields of engineering:

- Transistor device development**
- Transistor circuit applications**
- Automation and test equipment design**
- Microwave component development**
- Infrared radiation development**
- Transformer design**
- Resistor engineering**
- Electrical meter design**
- Production planning and control**

At Texas Instruments you will have the long-range stability of a 25-year-old firm with many notable "firsts" in the fields of semiconductors, geophysics, radar, infrared radiation, and others. You will enjoy the many living, cultural, and recreational rewards of the sunny Southwest. We would be glad to discuss these career opportunities with you . . . our profit-sharing plan and other personnel advantages at Texas Instruments.

*Write to Personnel Director*



**TEXAS INSTRUMENTS**  
INCORPORATED  
6000 LEMMON AVENUE DALLAS 9, TEXAS

**Bendix**  
needs

**ELECTRONIC  
and  
MECHANICAL  
ENGINEERS**

FOR AIRBORNE RADAR  
AND SONAR SYSTEMS

in  
**SOUTHERN  
CALIFORNIA**



Unusual engineering positions in electrical and mechanical design of Telemetering Systems are available. These positions, which are directly associated with our long-range projects for industry and for defense, are available at all levels.

There also are important positions open for Electronic Test Equipment Designers, Circuit Designers and Microwave and Transistor Engineers.

You are invited to consider becoming a member of this vital engineering group — with a forward looking company in Southern California.

*Please fill in the coupon or write us for complete information.*

W. C. Walker, Engineering Employment Manager  
Pacific Division, Bendix Aviation Corp.  
11608 Sherman Way, North Hollywood, Calif.

I am interested in Telemetering Engineering.

I am a graduate engineer with \_\_\_\_\_ degree.

I am not a graduate engineer but have \_\_\_\_\_ years experience.

Name \_\_\_\_\_

Address \_\_\_\_\_

City \_\_\_\_\_ Zone \_\_\_\_\_ State \_\_\_\_\_

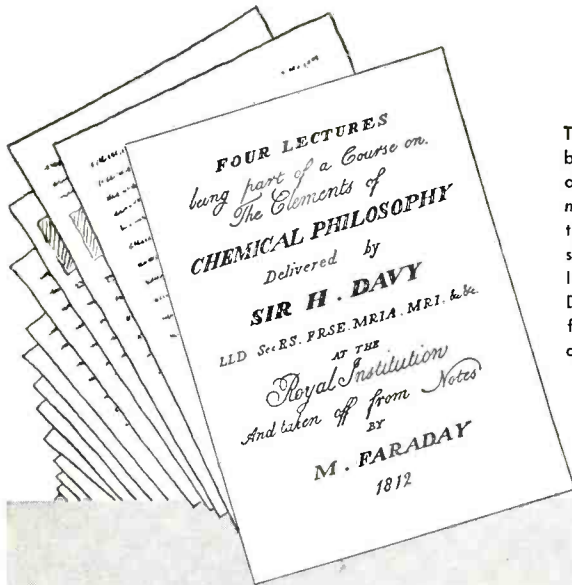

Title page of Faraday's beautifully illustrated set of notes that filled 386 manuscript pages. He sent the notes (which may still be seen in the Royal Institution Library) to Davy with a letter asking for a job as a laboratory assistant. (He got the job.)

# The application letter that **ELECTRIFIED** THE WORLD!



A set of tickets given young Michael Faraday, book binder's apprentice, not only admitted him to a series of lectures by Davy but opened the door to the Age of Electricity through his discoveries of the principles of the dynamo and the electric motor.

To men like Faraday who would like to associate themselves with eminent scientists, physicists and engineers, Farnsworth's doors are wide open. The genius that created electronic television continues to lead advances in radar; counter-measures; missile guidance; control, and test systems; industrial electronics; special purpose tubes; infra-red systems; solid state physics; electronic research, and production . . .

## **ENOUGH HERE TO CHALLENGE A HUNDRED FARADAYS**

Your resume (it needn't be 386 pages) will receive prompt, confidential attention.

Address Technical Employment Director  
**FARNSWORTH ELECTRONICS COMPANY, FORT WAYNE, INDIANA**  
A Division of International Telephone and Telegraph Corporation

## **Needed Now...**

### Engineering Talent

- in ■ Electronics
- Physics
- Mechanics



*Here's  
a Career  
with a  
Future!*

Here is a *career* opportunity for you to associate yourself with a rapidly growing organization. Industrial Research Laboratories is located in suburban Baltimore and is housed in buildings that were designed to be research laboratories. The organization is large enough to handle complex systems problems, yet small enough to insure individual recognition. Personnel are associated with all phases of projects to which they are assigned and have the advantage of participating in the entire project, not just a segment of it.

Industrial Research Laboratories has a liberal approach to vacations, sick leaves and incentive plans, and offers many additional benefits.

Our production and earning curves have been constantly on the upswing since our inception, and we have never discharged or furloughed an employee for lack of work.

If you are interested in a *career* with future, *write*:

## **INDUSTRIAL RESEARCH LABORATORIES**



*Div. of Aeronca Manufacturing Corp.*

Dept. A-10, Hilltop & Frederick Rds.  
Baltimore 28, Maryland



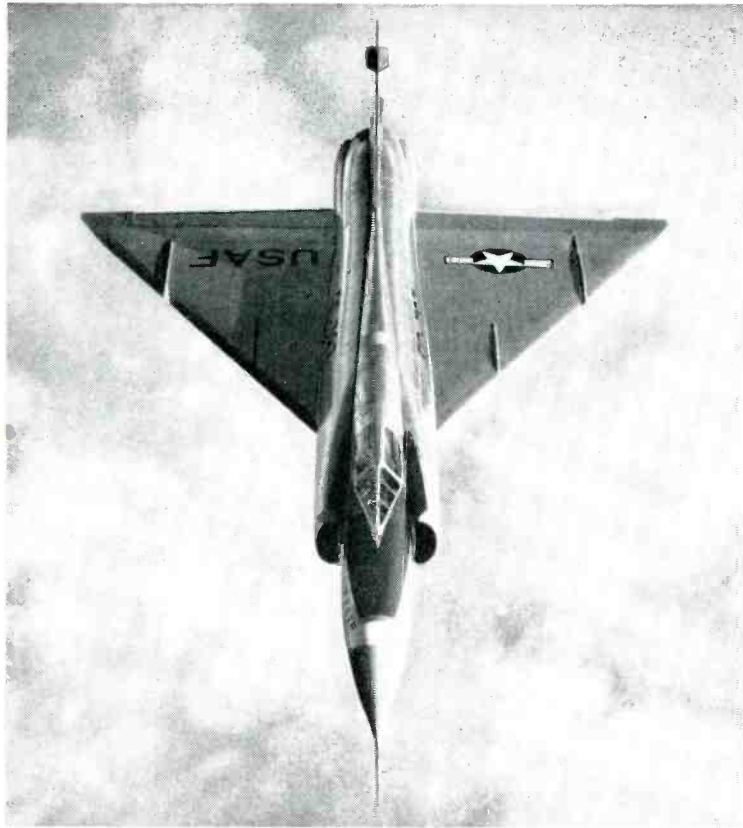

## THE CONVAIR CHALLENGE TO THE ENGINEER OF EXCEPTIONAL ABILITY

Beyond the obvious fact that Convair in San Diego offers you a way of living judged by most as the nation's finest from the standpoint of weather, beauty and interesting surroundings, the Convair Engineering Department offers you challenges found in few places.

It is, we believe, an "engineer's" engineering department — interesting, energetic, explorative — with the diversity that means security for capable personnel.

*As proof, consider this:* Convair developed and flew the world's first turbo-prop airplane, first delta-wing airplane, first vertical take-off airplane, first delta-wing seaplane — engineered and built the world's biggest transport, the world's safest high-performance commercial aircraft.

*Or this:* Convair's B-36 is the world's largest operational bomber, Convair's B-24 Liberator was World War II's most used heavy bomber, Convair's XP5Y-1 holds the world's endurance record for turbo-prop aircraft.

*Or this:* Convair was awarded the nation's first production missile contract and the first production contract for supersonic interceptors.

*Currently...* Convair has the greatest diversity of aircraft engineering projects in the country, including the F-102A supersonic interceptor, the new Metropolitan 440 airliner, the Convair 880 jet liner, the Atlas intercontinental ballistic missile, plus a long-range study of nuclear aircraft.

*Currently...* Convair has a completely integrated electronic development section engaged in advanced development and design on missile guidance, avionic projects and radar systems.

*Would you like to join us?* We earnestly need engineers of proven ability — men who want to make full use of their time, their minds, their skills and abilities solving the complex problems confronting us in these projects. If you are such a man, write us and we'll send you a free booklet about us, plus other interesting material to help you make the decision.

Write: H. T. BROOKS, Engineering Personnel

Department 922

**CV CONVAIR GD**  
A DIVISION OF GENERAL DYNAMICS CORPORATION

3302 PACIFIC HIGHWAY

**IN BEAUTIFUL SAN DIEGO, CALIFORNIA**

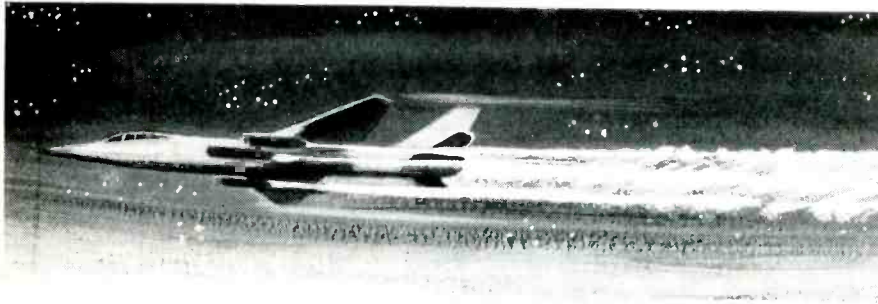

## Crosley Engineers ARE PUTTING THE EYES AND EARS IN SPACE!

*Do you fit into this Engineering drama?*

The daring approach . . . probing the dark recesses of the unknown. CROSLEY Electronics Engineers are taking the calculated risks which offer great discoveries as the triumphant reward.

Research and development in Communications and Radar now offer exciting possibilities. Here are areas now being explored.

- Radar—all phases
- Control Systems
- Digital Techniques
- Airborne Navigational Equipments
- Transmitters and Receivers
- Audio Circuitry
- Amplifiers
- Transistor Circuit Design

High calibre Engineers are needed to enter into these unusual programs. All benefits are available plus modern facilities. Relocation costs plus a 15 day subsistence allowance are paid by CROSLEY.

Please Send A Written Resume To:

**D. B. Nason**  
Vice President and Director of  
Engineering  
Dept. No. S



2630 Glendale-Milford Road, Evendale, Cincinnati 15, Ohio

*"Known for the NEWEST—Respected for the BEST!"*

the  
electronics  
engineer  
who can

# WRITE

is one of our favorite people

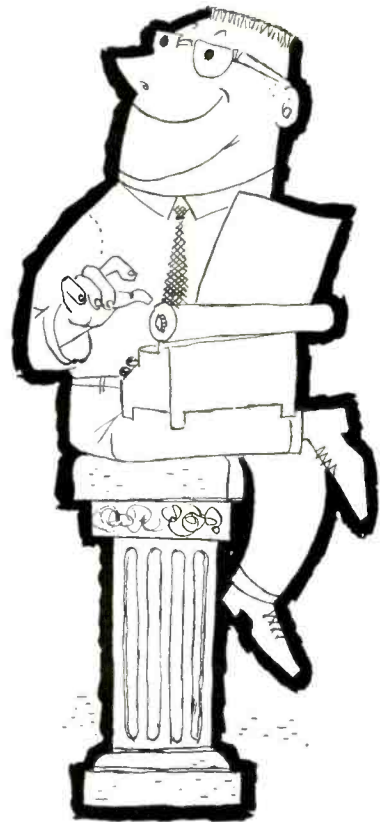

. . . if you're one of them, let us tell you about the opportunities for publications engineers at Collins . . .

*in the fields of . . .*

- |                       |                   |
|-----------------------|-------------------|
| Microwave Relay       | Flight Control    |
| Navigation Systems    | Radar Systems     |
| Communication Systems | Guided Missiles   |
| SSB Systems           | Computers         |
| Radio Astronomy       | Amateur Equipment |

Collins offers you top salary, rapid advancement, company benefits, liberal moving expense allowance. Electrical Engineers or Physicists are desired. Actual writing experience is not necessary . . . U.S.A. citizenship is.

Send resume to: Industrial Relations Director

### Collins Radio Company

Cedar Rapids, Iowa  
1930 Hi-Line Drive, Dallas 2, Texas  
2700 W. Olive Ave., Burbank, Calif.

# SENIOR ENGINEERS

write to W. L. Webb

## *Bendix* Guided Missiles



### SYSTEMS ANALYSIS

A fundamental problem in the development of guided missiles is analytical dynamics. For this work, we need Senior Engineers who have extensive backgrounds in the over-all dynamic behavior of missiles and weapons systems, as well as airframe systems of a missile. They will work with analogue computers, digital differential analyzers, breadboards, prototypes of missiles and missile equipment, and special mechanical and electronic simulators.

### MISSILE GUIDANCE

Senior Engineers, here is your opportunity to design and develop sub-systems, plan packaging components and supervise tests of prototype models for an extremely complex system of missile guidance, wherein experience in microwave, electronics, mechanics, and servo systems is essential. Particular emphasis is placed in solving vital problems relative to the performance of a missile under a variety of conditions and environments.

### TEST EQUIP. SR. ENG.

Test equipment is important to us in that it measures our product. If you feel that you have better than average engineering imagination, if you have 8-10 years of experience backed by a solid grounding in fundamentals, and if you can effectively put this to work in directing the design of new improved test equipment — such as automatically programmed testers to go-no-go comparators suitable for factory use—contact us.

### Also— Job Opportunities for Assistant Engineers Junior Engineers Technicians

A thirty-six-page book, "Your Future in Guided Missiles", describing in detail every phase of guided missile operation, will be sent to you on request. Write for your copy today.

At Bendix Products Division—Missiles Section, qualified engineers have the advantages of a compact, hard-hitting organization backed by all the resources of the nation-wide Bendix Aviation Corporation. If you can accept a challenge, want an opportunity to grow with a rapidly expanding technical business, and can accept the responsibilities that go with opportunity, I would like to hear from you personally—W. L. Webb, General Manager, BENDIX PRODUCTS DIVISION—MISSILES, 403A, Bendix Drive, South Bend, Indiana.



**Prime Contractor  
for  
TALOS MISSILE**

engineers . . . physicists  
**NEW** opportunities at  
**MOTOROLA** in Phoenix

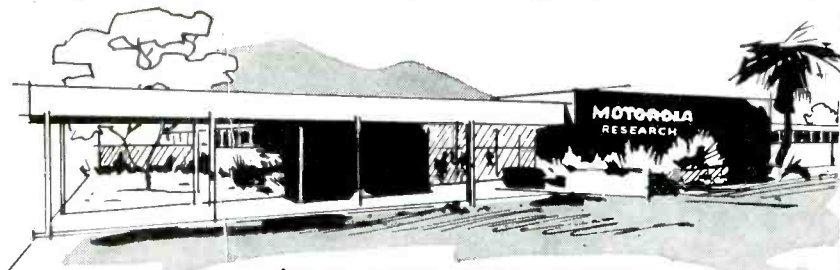

WORK IN A **VACATIONLAND**

(your family will love year-round outdoor living)  
**WHILE YOU ADVANCE YOUR CAREER**

Here are two of the country's newest and most complete Electronic Laboratories; (1) our expanding Military Research lab. and (2) our new Semi-Conductor Division. Both offer outstanding career advantages . . . (see listing below). This is your opportunity to get in on the ground floor of a swiftly expanding company. You'll enjoy working in air conditioned comfort in the most modern and well instrumented laboratories . . . with liberal employee benefits, including an attractive profit sharing plan and association with men of the highest technical competence.

Salary levels are open and commensurate with ability. You'll like working with Motorola in Phoenix, where there's room to grow and it's fun to live.

**MOTOROLA IN PHOENIX HAS OPENINGS FOR:**  
**Electronic Engineers, Mechanical Engineers, Physicists, Metallurgists, and Chemists, in the following categories:**

**Research Laboratory**

- Microwave Antennas
- Pulse and Video Circuitry
- Radar Systems Design
- Circuit Design
- Electro-Mechanical Devices
- Systems Test
- Transistor Applications

**DRAFTSMEN**

**Semi-Conductor Division**

- Transistor Application
- Transistor Devices
- Solid State Physics
- Physical Chemistry
- Metallurgical Engineering
- Production Engineering
- Transistor Sales Engineering

**Electrical Design and Layout**

for above positions write to:

Mr. R. Coulter, Dept.  
 3102 N. 56th St.,  
 Phoenix, Ariz.

for above positions write to:

Mr. V. Sorenson, Dept.  
 5005 E. McDowell Rd.,  
 Phoenix, Ariz.

**Excellent opportunities in RIVERSIDE & CHICAGO, too**

**RIVERSIDE, CALIF.,** Exceptional openings in Military Operation Analysis, Analog Computer Flight Simulation, Digital Computer Analysis, Microwave Systems, Servo Mechanisms, Missile Systems, Aerophysics.

Write to:

Mr. C. Koziol, Dept.  
 P O Box 2072  
 Riverside, California

**CHICAGO, ILL.,** Challenging positions in Two-Way Communications, Microwave, Radar and Military Equipment, Television (Color), Radio Engineering, Field Engineering, and Sales Engineering.

Write to:

Mr. L. B. Wrenn, Dept.  
 4501 Augusta Blvd.  
 Chicago 51, Ill.

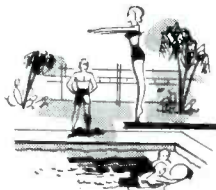

**ELECTRONIC ENGINEERS!**

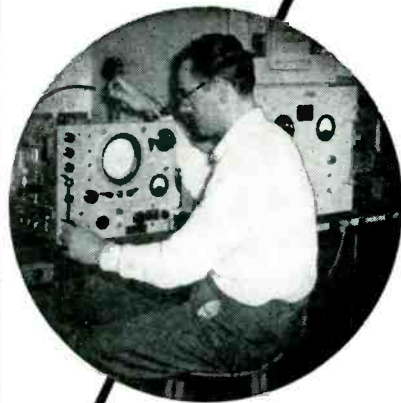

ARE YOU ENGINEERS . . . OR TIME CARD NUMBERS?

If you are tied up in red tape . . . if the scope of your work is limited . . . if you can't use your creative engineering abilities . . . then MEMCO offers you a sound escape from stagnation and monotony.

AT  
**MEMCO:**

every electronic engineer . . .

- is encouraged to use his creative talents.
- works on all phases of his projects.
- is appreciated as an engineer, not as a replaceable cog in a big machine.
- gets top pay and many benefits.
- can build a sound, worthwhile future.

For full details please write to:

**MARYLAND ELECTRONIC**

MANUFACTURING CORPORATION

5009 Calvert Road

College Park, Maryland

(A suburb of Washington, D. C.)



**MOTOROLA**



## Here's one **for you**

Inside this folder is a problem. It may be on missiles, on plastics, on structures, on electronics, on any of the diverse fields of engineering for which Goodyear Aircraft is renowned. Whatever it is, you can be sure it represents a real and important engineering challenge.

If you are a creative engineer, with faith in your ideas and confidence in your ability to make them work, *this* may be the challenge *you* have been seeking. For, due to our growth and diversification, we find it necessary to expand our engineering staffs at both Akron, Ohio, and Litchfield Park, Arizona. Opportunities are unlimited for rewarding professional careers in all specialties of engineering.

And, we mean *careers*—not just *jobs*. For here, your imagination and ingenuity are our raw materials. Here, your every idea has a chance. And, in transforming your ideas into practical realities, you will discover the exciting stimulation of creative challenge leading to a real satisfaction of accomplishment.

At Goodyear Aircraft you will discover a diversification rarely found under one roof. Whatever your specialty, you will find opportunities in every phase of aviation—civil and military.

Salaries and benefits are, of course, liberal. And, if you wish to continue your academic studies, company-paid tuition courses leading to advanced degrees are available at nearby colleges.

For further information on *your* career opportunities at Goodyear Aircraft, write: Mr. C. G. Jones, Personnel Department, Goodyear Aircraft Corporation, Akron 15, Ohio.

They're doing big things at

**GOOD YEAR**  
**AIRCRAFT**

THE TEAM TO TEAM WITH in AERONAUTICS

JOIN  IN BOSTON

Boston, and New England, is in the middle of a gigantic electronic boom... in fact, this is the NEW electronic center of America.

A leader in this movement is the Electronics Division of American Machine & Foundry Company in Boston... surrounded by the nation's leading universities, outstanding historical sites, and gateway to all New England's 4-season resorts and sports... easily accessible on new super highways. And our smart, modestly priced suburban home communities are models for today and tomorrow.

Work with outstanding colleagues in creative engineering where assignments are diversified and the programs long-range.

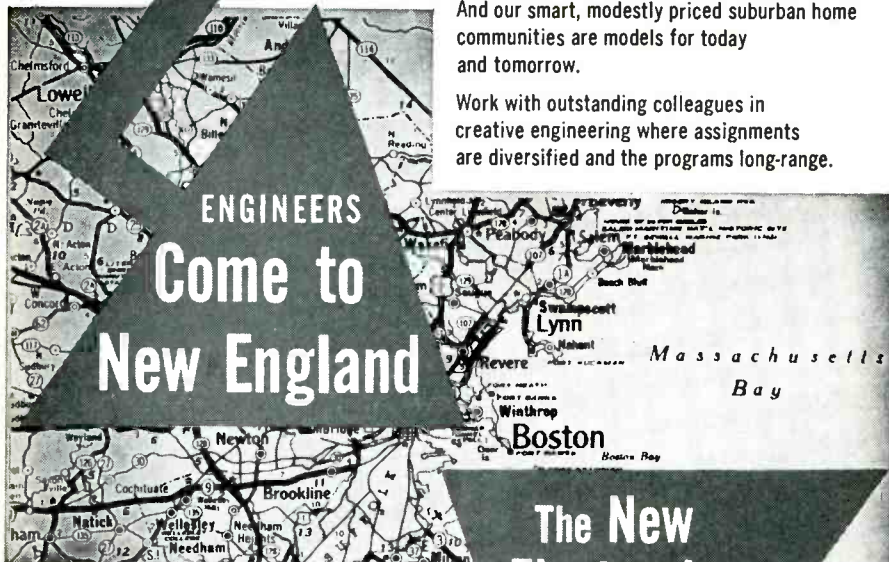

We have important openings for:

**SYSTEMS ENGINEERS**

to work on the development of Digital Data Processing and Display and Radar Training Equipment

Responsible for the development of an overall systems design, and for direction of unit design engineers to achieve the systems requirements. Must have broad design experience in applicable systems components and a degree in Electrical Engineering.

Positions where your talents can have full scope—in an engineering department where virtually all administrative and staff positions have been filled from within our own ranks. Unlimited growth opportunities. Added responsibilities accorded as abilities warrant.

Relocation Expenses & housing assistance. Comprehensive benefits program including tuition reimbursement plan for advanced studies.

Please send complete resume to Mr. Paul Dorr

**ELECTRONICS DIVISION**

**American Machine & Foundry Company**

1085 Commonwealth Avenue Boston, Massachusetts

**ENGINEERS**

**AC** *needs*

**SERVO ENGINEERS**

... Electrical  
... Mechanical

**GM**

**INERTIAL GUIDANCE SYSTEM PROGRAM**

**ELECTRONICS DIV.,**

Milwaukee 2, Wis.

Seeks experienced engineers for the further development and systems testing of Inertial Guidance Systems and their Servo Loops.

Enjoy Challenging Opportunities in the most versatile Laboratories in the country. Work with the top men in the field and with the finest test, research and development facilities. We are in the process of a Major, Permanent, Expansion Program. New Plant facilities being added in suburban Milwaukee area.

To aid you in your professional advancement AC will provide financial assistance toward your Master's degree. A Graduate Program is available evenings at the University of Wisconsin, Milwaukee.

GM's Electronics Division aggressive position in the field of manufacture and GM's long-standing policy of decentralization creates individual opportunity and recognition for each Engineer hired.

**Recent EE,ME Graduate Inquiries Also Invited**

Milwaukee offers ideal family living in a progressive neighborly community in cool, southern Wisconsin where swimming, boating, big league baseball and every shopping and cultural advantage is yours for the taking.

To arrange personal, confidential interview in your locality send full facts about yourself today to

Mr. John F. Heffinger  
Supervisor of Salaried Personnel

**AC** **Electronics Div.**  
**General Motors Corp.**  
**Milwaukee 2, Wis.**



*Excellence in Electronics*

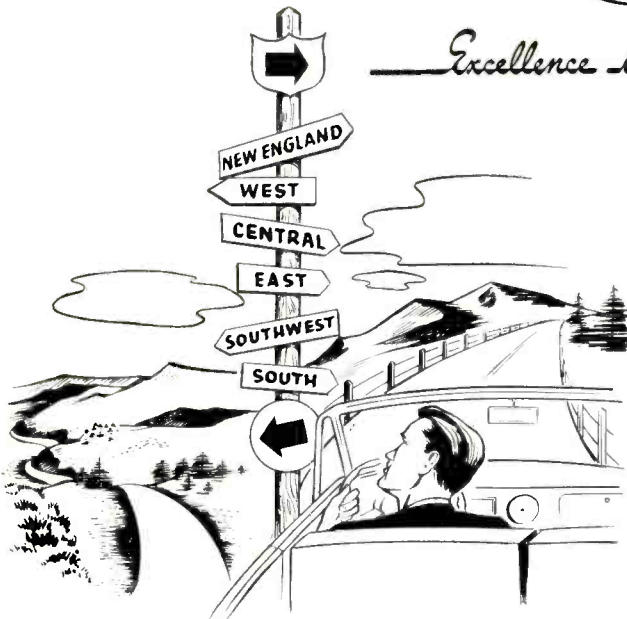

## Which direction are you going?

The Boston Area has everything . . .  
Fine Suburban Living  
Exceptional educational and cultural facilities  
Nearby famous winter sports and summer  
resort areas, and—

Opportunity to Travel the Road to Success  
with RAYTHEON in the fields of AIRCRAFT  
NAVIGATIONAL AND CONTROL SYS-  
TEMS, and GUIDED MISSILES.

As one of the largest, fastest growing and most progressive Electronics Companies in New England RAYTHEON can offer—numerous advancement possibilities, interesting professional challenges, tuition support plan for engineering courses, regular salary review, adequate supporting technical personnel, large company advantages, including Life and Health Insurance, paid vacations, and other employee benefits.

We are interested in ENGINEERS for:

- CIRCUIT DESIGN
- ELECTRONIC RELIABILITY & TEST EQUIPMENT
- ELECTRONIC PRODUCT DESIGN
- RADAR SYSTEMS
- TUBE APPLICATIONS
- MECHANICAL DESIGN
- ANALOG COMPUTERS
- MICROWAVE COMPONENTS
- AERODYNAMICS
- MECHANICAL PROCESS ENGINEERING
- SPECIFICATIONS ENGINEERING

Call or send resume to  
G. P. O'Neil  
CRestview 4-7100, Ext. 224



**MISSILE  
SYSTEMS  
DIVISION**

**B E D F O R D , M A S S .**

# ENGINEERING UNLIMITED

... an established concept at Convair-Pomona where your opportunities in the career of your choice are virtually unlimited. Work in the finest engineering facility in the country at America's first exclusive Guided Missile plant. Ultra-modern surroundings, completely air-conditioned, in beautiful Pomona only minutes from Los Angeles, the mountains, the seashore or desert recreation. Here is country living near the city at its best:

*Excellent opportunities available now in:*

- ELECTRONICS**
- DYNAMICS**
- AERODYNAMICS**
- THERMODYNAMICS**
- OPERATIONS RESEARCH**
- HYDRAULICS**
- MECHANICAL DESIGN**
- LABORATORY TEST ENGINEERING**

Generous travel allowance to Engineers who are accepted. Write now enclosing a complete resume to:

**Employment Dept. 3-G**

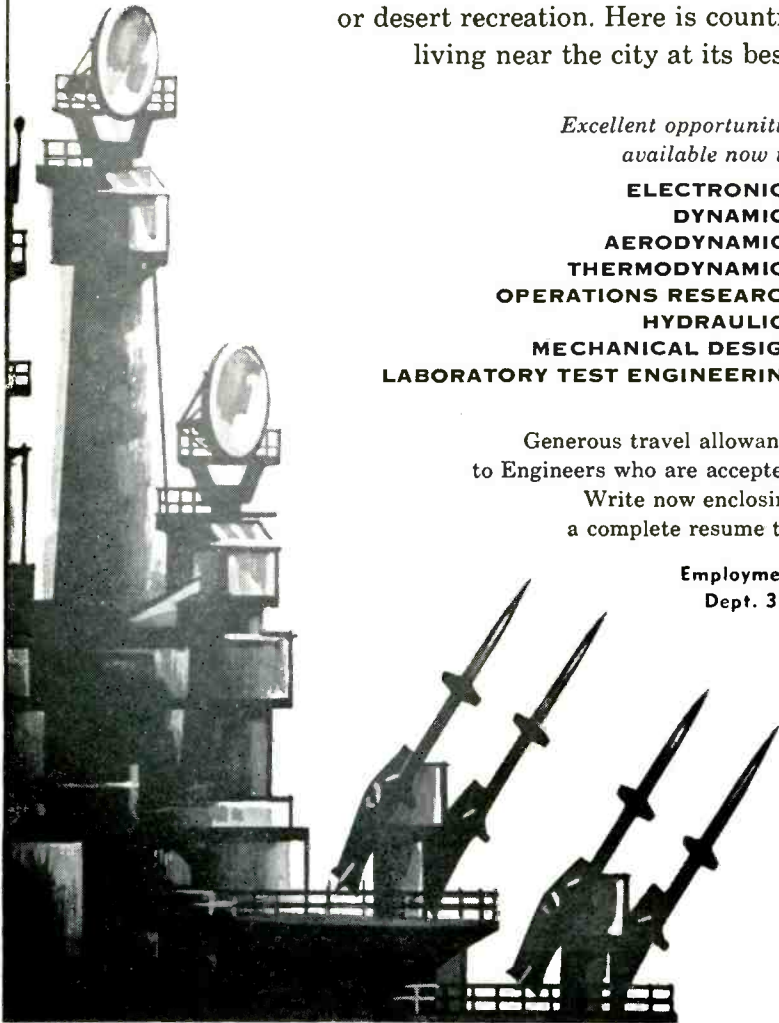

**CONVAIR**  
 A DIVISION OF  
 GENERAL DYNAMICS  
 CORPORATION  
**POMONA**  
 CALIFORNIA



## ELECTRONIC ENGINEERS

### RESEARCH DEVELOPMENT

Expansion of our engineering department requires electronic engineers with radar, servo, sonar or transistor circuit experience. Excellent opportunity for advancement with top-calibre associates. New modern plant in the suburbs with ideal laboratory facilities and well-trained technical assistants.

*Other Opportunities in the following areas:*

- **TECHNICAL WRITERS**
- **DRAFTING** Electrical Layout
- **DETAILING** Electrical - Mechanical

### DESIGN ENGINEERS

Must have EE degree or equivalent, with 3-5 years experience in one of the following:

- Flight Simulators
- Analog Computers
- Radar & Sonar Trainers
- Radar Guidance & Fire Control Systems
- Redesign, Modification & Testing of Radar & Electronic Systems
- Electronic Installation & Maintenance
- Coil & Transformer Design
- Packaged Power Supplies

*Other Openings For:*

### COMMUNICATIONS EQUIPMENT DESIGNERS

### COMPUTER DESIGNERS

### FIELD ENGINEERS

(\* Must have E.E. degree or equivalent with 5-10 yrs. experience.  
 \*Positions located throughout USA

#### LOCATION:

On U. S. Highway 22, thirty miles (45 minutes) from New York City.

#### ENVIRONMENT:

One of the finest plants of its kind . . . spacious, modern, air-conditioned. Conducive to bringing out the best of your abilities!

#### ABOUT THE COMPANY:

Organized in 1945. Engaged in research, design and development for the Armed Services.

#### ITS BENEFITS:

- Pension Plan
- Group Life Insurance
- Paid Holidays
- Paid Sick Leave
- Paid Vacations
- Education & Tuition Assistance
- Other Group Insurances

#### Interviews in Your Community by Appointment

*Send complete resume, write or call personnel director.*

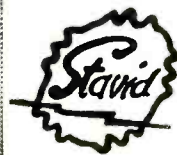

**STAVID**  
**ENGINEERING**  
 Incorporated  
 U. S. Highway 22  
 Watchung, P. O.  
 Plainfield, N. J.  
 Plainfield 7-1600



# Air Force "Super-Snooper" SEES ALL... TELLS ALL

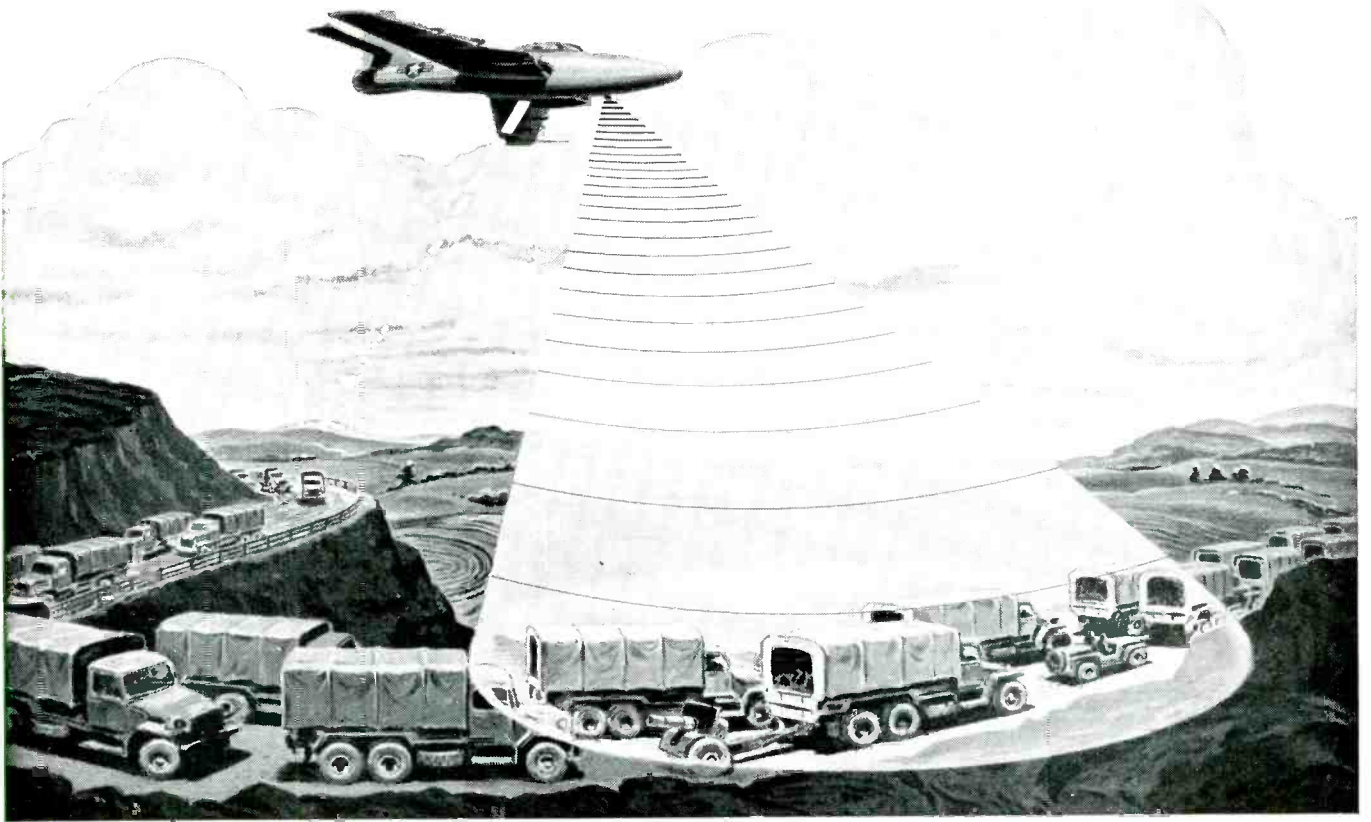

## Reconnaissance television moves GHQ directly over any target zone

Philco and the United States Air Force have perfected a far-seeing "third eye" . . . strategic airborne television. Now the Military Command can watch the TV screen as though it were a living, moving map . . . and direct distant maneuvers and operations as though they were on the scene.

### Mr. Electronics Engineer:

Opportunities are limitless in electronic and mechanical industrial engineering and research for men who apply to Philco now. Even more, Philco has one of the most liberal profit-sharing, retirement and insurance programs in all industry.

*Write, Phone Collect or Apply in person to John F. Morrissey  
. . . your Inquiry will be held in strictest confidence*

**PHILCO is Currently Engaged in Long Range Industrial and Diverse Military Engineering Fields**

- Guided Missiles • Radar • TRANSAC Digital Computers • Underwater Ordnance • Bombing and Fire Control Systems • Servo-Mechanisms • Microwave Communication Systems • Infra-Red Devices • Transistor Circuit Application • Multiplex Equipment • Television Relay Systems • Industrial TV • Color Broadcast Equipment • Forward Scatter Communications • Fire Control Systems • REDAP

**PHILCO CORPORATION**  
GOVERNMENT and INDUSTRIAL DIVISION • PHILADELPHIA 44, PENNA.



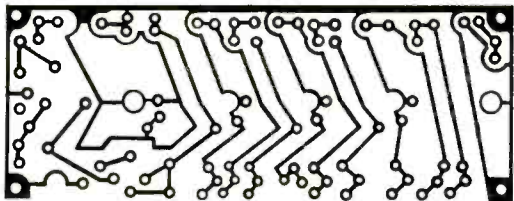

## ELECTRICAL ENGINEERS

If you have had engineering experience in any of the categories shown below, Northrop Aircraft has an attractive position for you, with many benefits. Important among them are high compensation, challenging assignments, steady advancement, recognition of initiative and ability, and continued interest in your progress. Many outstanding engineering positions are offered, as follows:

**ELECTRICAL GROUP**, which is responsible for the design of such things as power generation and distribution systems, rectifiers and power converters, and auxiliary systems as applied to manned aircraft, guided missiles and ground support equipment.

**COMMUNICATIONS AND NAVIGATION GROUP**, which is responsible for the design of C/N systems in manned aircraft and installation of guidance systems in missiles.

**FIRE CONTROL RADAR GROUP**, which is responsible for the installation and application of the most advanced type of fire control systems in fighter-interceptor aircraft. The work covers the installation of the equipment and associated wiring; continuing liaison with equipment manufacturers; preparation of system analysis and reports; and follow-up of system performance in the field as aircraft become operational.

**INSTRUMENT GROUP**, which is responsible for the design of instrument systems for manned aircraft and the installation of flight test instrumentation for guided missiles.

There are also opportunities for draftsmen with either electrical or mechanical experience.

At Northrop Aircraft you will be with a company that has pioneered for seventeen years in missile research and development. Here you can apply your skill and ability on top level projects such as Northrop's new supersonic trainer airplane, Snark SM-62 intercontinental missile, and constantly new projects. And you'll be located in Northrop's soon to be completed multi-million-dollar engineering and science building, today's finest in comfortable surroundings and newest scientific equipment.

If you qualify for any of these representative positions, we invite you to contact the Manager of Engineering Industrial Relations, Northrop Aircraft, Inc., ORegon 8-9111, Extension 1893, or write to: 1015 East Broadway, Department 4600-T, Hawthorne, California.



## NORTHROP

NORTHROP AIRCRAFT, INC., HAWTHORNE, CALIFORNIA

Producers of Scorpion F-89 Interceptors and Snark SM-62 Intercontinental Missiles

ENGINEERS . . .

## control systems

Research and Development  
for  
AIRCRAFT NUCLEAR  
PROPULSION

Exceptional opportunities are now available in this General Electric Department for control systems engineers who want to be in the lead in their art. You can't be further ahead than the development of control systems for aircraft nuclear power plants. You can't find greater scope than this group charged with executing complete projects—from idea through research and development to testing.

OPENS EXIST  
AT VARIOUS LEVELS IN:

- Systems Analysis
- Servomechanisms
- Systems Applications
- Printed Circuits
- Environmental Testing
- Saturable Core Components

at Cincinnati, Ohio and  
Idaho Falls, Idaho

In addition to these professional advantages, you'll enjoy the many personal benefits that go with being part of General Electric.

Send reply in confidence, stating salary requirements, to location you prefer.

Mr. J. R. Rosselot  
P. O. Box 132  
Cincinnati, Ohio

Mr. L. A. Munther  
P. O. Box 535  
Idaho Falls, Idaho

GENERAL  ELECTRIC

**PHYSICISTS—**  
*advance in the  
mushrooming  
field  
of*

**MICROWAVE TUBES**

KEY  
to your future  
SYLVANIA'S  
Microwave Tube  
Laboratory



Write Gordon McClure  
**SYLVANIA ELECTRIC PRODUCTS INC.**  
500 Evelyn Avenue, Mountain View, California

we're in  
Milwaukee so we ought  
to know!



## An AC\* ENGINEER TELLS HIS STORY



Working at AC, THE ELECTRONICS DIVISION OF GENERAL MOTORS is exciting . . . challenges every inch of my engineering ingenuity, currently I am working on a phase of the Inertial Guidance System Program. A month or two ago I was equally absorbed in our Jet Engine Fuel Control Program. I am certainly growing ENGINEERING "KNOW-HOW-WISE" and my salary checks reflect it. I started at a good salary . . . have had regular increases in salary and position . . . gosh, I like it here.

AND, I enjoy AC's MASTER'S DEGREE PROGRAM, University of Wisconsin—Milwaukee. I attend evening classes and AC is paying my tuition and with no strings attached.

My family enjoys Milwaukee too. Here in cool, southern Wisconsin we have endless miles of swimming beaches, parks, playgrounds that are ours for the asking. We have the cultural and shopping advantages of the big city in a community long known for its small town hospitality.

**P.S.** AC's Permanent Expanding Electronic Program provides openings for more Mechanical, Electrical Engineers and Engineering Technicians. Even "square pegs" are provided "square holes" at AC.

Write today in strictest confidence to my friend, Mr. J. F. Heffinger, Supervisor of Salaried Personnel.

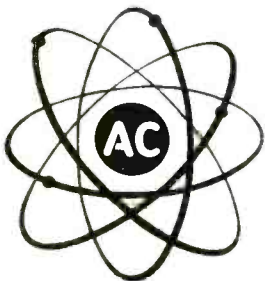

\*AC THE ELECTRONICS DIVISION  
**GENERAL MOTORS CORPORATION**

Milwaukee 2, Wisconsin

•

Flint 2, Michigan

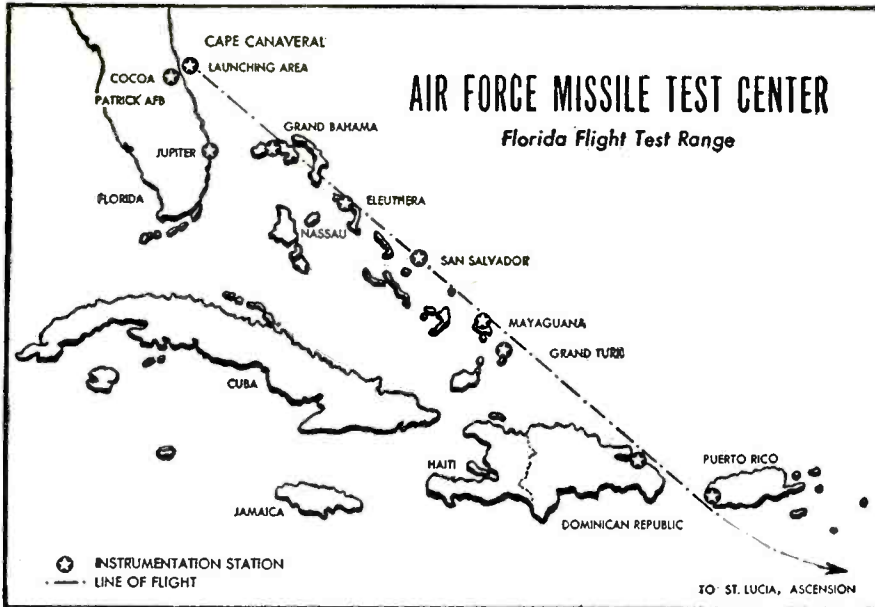

*Engineers and Scientists:*

**INSTRUMENTATION SYSTEMS ENGINEERING  
for MILITARY APPLICATIONS**

**SALARIES UP TO \$14,000.**

IN THESE NEW PROGRAMS AT THE MISSILE TEST PROJECT, FLORIDA

Have you as an engineer or scientist considered the problems and projects associated with the instrumentation and control of a long range missile, guided over a course that extends thousands of miles?

To achieve precision performance, missile launching and guidance require a vast network of instrumentation and control. New development programs have created challenging opportunities for Electronics Engineers, and Scientists who are interested in data acquisition, transmission, recording and processing systems.

A world leader in electronics provides instrumentation for the Air Force Long Range Testing Laboratory, which extends from Patrick Air Force Base, on the Central East Coast of Florida, to the Mid South Atlantic.

You will enjoy top salaries, liberal company-paid benefits, and ideal Florida living for you and your family. Relocation assistance, too.

**TODAY . . . get complete information on arrangements for personal interview. Send a complete resume of your education and experience to:**

**PERSONNEL MANAGER  
MISSILE TEST PROJECT—Dept. N-10K  
P. O. Box 1226  
Melbourne, Florida**

**MISSILE TEST PROJECT  
Melbourne, Florida**

# Semiconductor Development

**PHYSICISTS  
ENGINEERS**

*for*

- Research
- Development
- Applications
- Production
- Sales

Here is your chance to work with stimulating, congenial associates in a company atmosphere that is informal and free of red tape. You will be located in pleasant, suburban Boston, where cultural, educational and recreational advantages are found for you and your family.

In a few short years Transitron has carved out a leading position in the field of semiconductors. Today approximately 900 people are employed in two plants having over 300,000 square feet.

So if your experience is in

- Physics
- Component Engineering
- Applications Engineering
- Production Engineering
- Sales Engineering

there is an unparalleled opportunity for you right now at Transitron. Call or write . . .



**Transitron**  
electronic corporation

MELROSE, MASSACHUSETTS  
MElrose 4-9600

INTACC is AN/SPA-22 (XN-1)

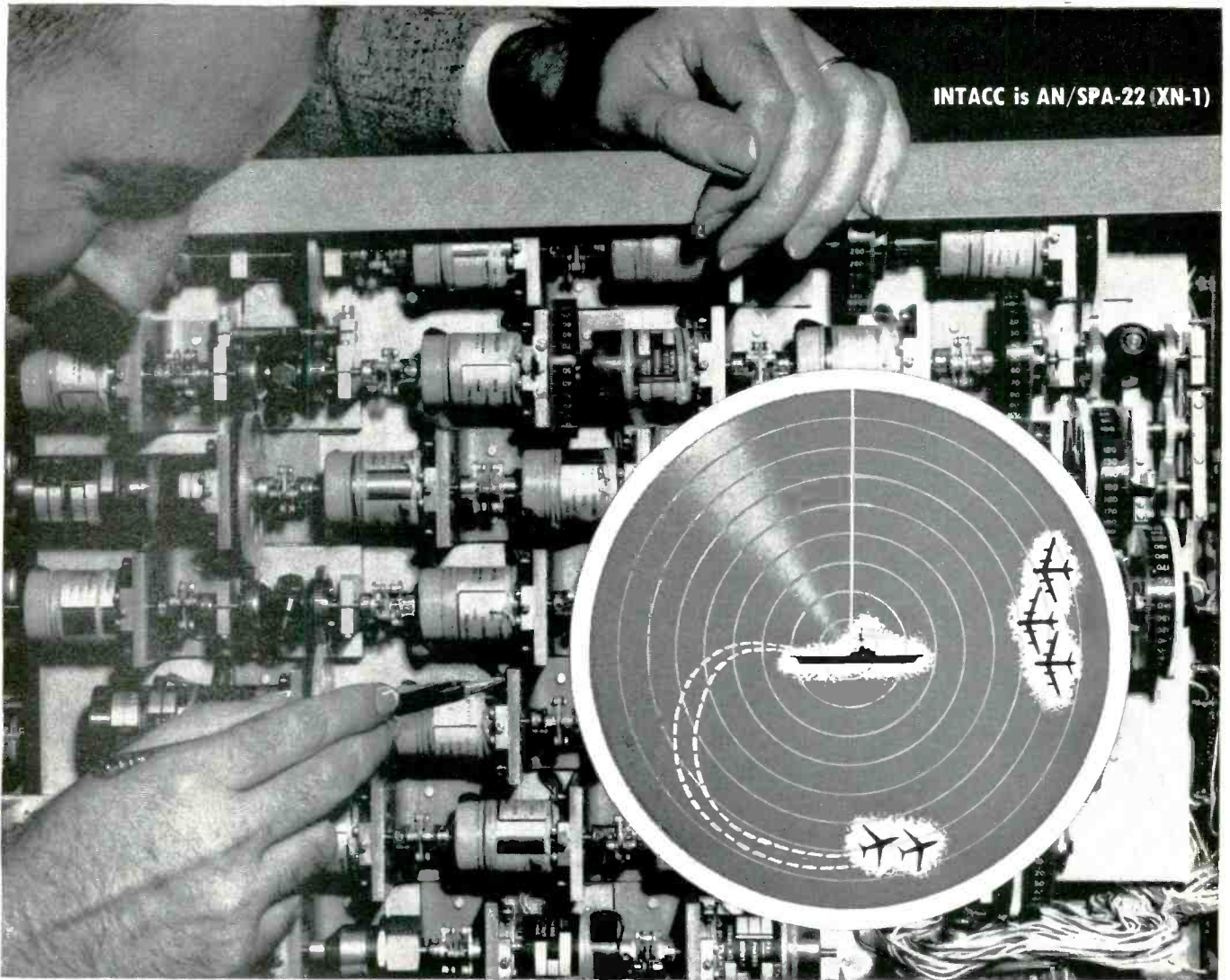

# COMPUTERS

## AT CORNELL AERONAUTICAL LABORATORY

Pictured above is the "heart" of INTACC, our project name for Intercept Tracking and Control Console. It wasn't built to any preconceived specifications, but developed by C.A.L. and recommended as a solution to a vital military problem.

INTACC is actually a coordinated group of electronic computers that not only introduces greater accuracy to the art of intercept control but, by relieving the air controller of former routine responsibilities, enables him to make better use of his own skill and abilities.

INTACC is but one of 160 separate projects currently active at C.A.L. Many of them involve electronics research, not only in intercept tracking and control equipment, but in the fields of search radar, flight-path prediction, target discrimination and missile systems. All offer interesting opportunities for the professional man with a probing mind.



**CORNELL AERONAUTICAL  
LABORATORY, INC.**  
OF CORNELL UNIVERSITY



The story behind Cornell Aeronautical Laboratory and its contributions to aeronautical progress is vividly told in a 68-page report, "A Decade of Research." Whether you are interested in C. A. L. as a place to work or as a place to watch, you will find "A Decade of Research" both useful and pertinent. Mail in the coupon now for your free copy.

**W. L. DIEFENBACH**  
**CORNELL AERONAUTICAL LABORATORY, INC.**  
Buffalo 21, New York

Please send me a copy of "A Decade of Research."

Name \_\_\_\_\_

Street \_\_\_\_\_

City \_\_\_\_\_

Zone \_\_\_\_\_

State \_\_\_\_\_

Please send employment information.

**ENGINEERS:** *Electronic & Mechanical*

**Physicists:**

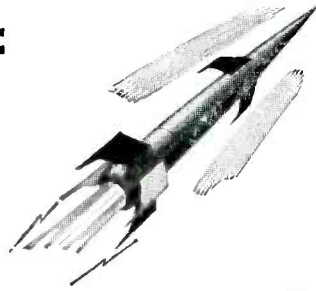

**Work where  
PERFORMANCE pays off**

Men of talent and drive can move ahead without delay or red tape at Melpar because skill, ability and performance are the *primary* factors governing advancement. Due to the fact that we've doubled in size every 18 months since our beginnings in 1945, middle and top level positions open up constantly.

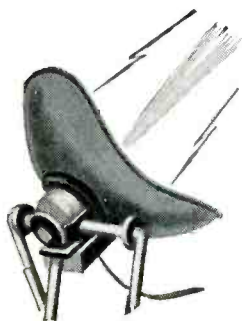

Melpar believes that the engineer deserves an organization and facilities that can enhance his creative abilities. For this reason our laboratories were designed and built to specifications prepared by Melpar engineers. A wealth of equipment is available. Our project group system enables the engineer to participate in all phases of development problems and thus quickly acquire greater technical and administrative know-how, essential to eventual managerial responsibility. The system also enables us to more accurately evaluate the individual's contribution and more rapidly justify promotions.

**Live Where You LIKE It**

Living—for the whole family—is immensely rich in the two locales where Melpar's R & D activities are centered. Our 265,000 sq. ft. main laboratory near Washington, D. C., enables you to live in an area enjoying incomparable cultural and recreational advantages. The climate allows outdoor recreation 215 days of the year. Fine homes and apartments are available in all price ranges. Our Watertown and Boston, Mass. laboratories offer the unique advantages of cosmopolitan Boston with its theatres, concerts, art galleries, museums, universities and schools which are second to none. Nearby are seaside and mountain resorts offering a variety of winter and summer sports.

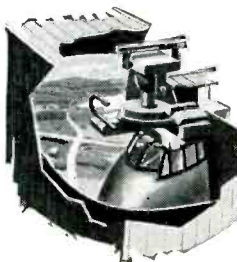

**Openings Exist in These Fields:**

- Flight Simulators • Radar and Countermeasures • Network Theory • Systems Evaluation • Microwave Techniques • Analog & Digital Computers • Magnetic Tape Handling • UHF, VHF, or SHF Receivers • Packaging Electronic Equipment • Pulse Circuitry • Microwave Filters • Servomechanisms • Subminiaturization • Electro-Mechanical Design • Small Mechanisms • Quality Control & Test Engineering



Write for complete information. Qualified candidates will be invited to visit Melpar at Company expense.

Write: Technical Personnel Representative



**MELPAR, Inc.**

A Subsidiary of Westinghouse  
Air Brake Company



**3196 Arlington Blvd., Falls Church, Va.**  
10 miles from Washington D. C.

Openings also available at our laboratories in Watertown and Boston, Mass.

**THE UNIVERSITY of MICHIGAN  
ENGINEERS and  
SCIENTISTS**

Unusual opportunities for outstanding and experienced men are available at The University of Michigan's Willow Run Laboratories. Research Engineers and Physicists with advanced degrees and and/or experience in the fields of:

- DIGITAL COMPUTER • LOGICAL DESIGN • INFRARED • ACOUSTICS • DIGITAL COMPUTER PROGRAMMING ELECTROMAGNETIC THEORY • COMMUNICATIONS CIRCUIT DESIGN • COMPONENT DEVELOPMENT • RADAR • OPTICS ENGINEERING • SYSTEMS DESIGN

Salary commensurate with training and experience. Excellent working conditions. Liberal vacation policy along with other fringe benefits. Unusual opportunity to carry on University graduate studies while working full time. Moving expenses paid. U. S. Citizenship required.

Write, giving details of education and experience, to

**A. J. Procassini**

The University of Michigan  
Willow Run Laboratories  
Ypsilanti, Michigan

**opportunities in**

**OPERATIONS  
RESEARCH**

The Operations Research Office of The Johns Hopkins University offers exceptional opportunities for scientists who prefer the challenge of operational problems of unusual scope and diversity to routine design and development work.

Our current research program has openings for men qualified in electronics and physics who are particularly interested in:

- Mathematical Analysis
- Determining applications of known photographic, acoustic, infrared and radar techniques to military problems
- Military communications systems planning, analysis and evaluation
- Electronic Countermeasures Analysis

Please send your resume to  
Research Personnel Officer

THE OPERATIONS RESEARCH OFFICE

**THE  
JOHNS HOPKINS  
UNIVERSITY**

7100 Connecticut Avenue  
Chevy Chase, Md.

GETTING ..... NOWHERE ?  
 .....  
 .....

## RAYTHEON FIELD ENGINEERING HAS A FUTURE!

Ready to go ahead? Field engineering at Raytheon is an open door to advancement. We recognize ability just as quickly as seniority. Many of our executives were formerly field engineers. And Raytheon's Field Engineering Section is continually expanding to meet the need for laboratory and field support of new electronic equipment.

Engineers with suitable experience are assigned highly responsible project engineering positions. In this capacity they provide liaison with company engineering laboratories and our military and industrial customers.

Our primary interest is in men who have field experience and a degree in Electrical Engineering. However, an extensive electronics background, which includes applicable missile, radar or sonar experience, will be given full consideration. We also have a few positions for men familiar with mechanical and hydraulic technics.

Your future at Raytheon includes attractive salaries — regularly reviewed for merit increases; relocation expenses; paid life and accident insurance; company-paid educational plan — other benefits and allowances. Write to E. K. Doherr for information.

*Excellence in Electronics*



**RAYTHEON MANUFACTURING COMPANY**

Government Service Department

100 River Street, Waltham 54, Massachusetts



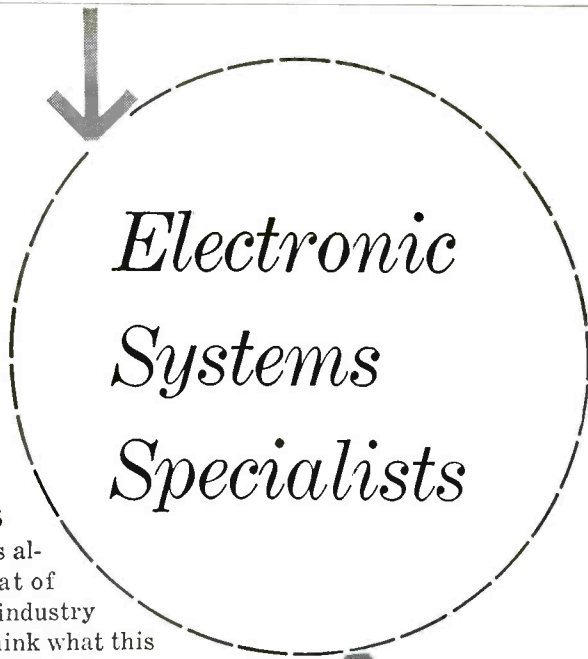

*Electronic  
Systems  
Specialists*

**SYLVANIA'S**

rapid growth is almost twice that of the electronics industry as a whole... think what this can mean to *you* in opportunity and rapid advancement. And Sylvania helps underwrite your advanced studies in leading universities in both locations... because we want you to assume greater responsibility and leadership. Here are some typical problems being solved by Sylvania engineers and physicists in our Buffalo, N. Y. and Waltham, Mass. laboratories.

**AT BUFFALO:**

1. How do you design 10 similar microsecond timing circuits whose delay times can be varied over a range of 100 times by analog control voltage maintaining a tracking accuracy of  $\pm 0.1\%$  in an environment of  $-65^{\circ}\text{C}$  to  $+125^{\circ}\text{C}$  at sea level to 100,000 feet?
2. If you know which bits of a code group are in error, can you modify the hamming code to use these data to provide maximum information capacity in a noisy channel?
3. Can you design a crystal mixer to operate with latest production type crystals and having a noise figure less than 12db above KTB operating in the "S"-band?

If you believe that you can assist us in the solving of these problems, please write:

**BUFFALO  
LABORATORY**

E. F. Culverhouse  
175 Great Arrow Ave.  
Buffalo 7, N. Y.

**AT WALTHAM:**

4. What are the statistical factors to be considered in calculating the detection probability of a search radar?
5. What is the effect of atmosphere turbulence on high gain antenna performance?
6. How is the sidelobe level of a radar antenna effected by random perturbations of phase and amplitude over the aperture?
7. How does the AGC bandwidth effect the accuracy of angle-tracking?

**WALTHAM  
LABORATORIES**

Erling Mostue  
100 First Ave.  
Waltham, Mass.

Your inquiries  
will be answered  
within 2 weeks.



**ARIZONA**

Famous for Its Climate  
and for Western Living

**GOODYEAR  
AIRCRAFT  
CORPORATION**

**ELECTRONIC LABORATORY**

Arizona Division  
Litchfield Park, Arizona

Modern schools and housing  
available. Outdoor recreation  
the year 'round.

This modern laboratory is the Western Division of the well-established Aerophysics Department of the Goodyear Aircraft Corporation of Akron, Ohio.

A Subsidiary of the

**GOODYEAR TIRE & RUBBER CO**

Openings are available for experienced personnel and recent college graduates.

Complete Missile and Electronic Systems  
Microwaves, Servomechanisms,  
Radars and Stabilized Antennas

Transistor Application,  
Electronic Packaging,  
Electronic Ground  
Support Equipment

Long range research and  
development projects.

University of Arizona graduate studies  
available under the Goodyear Fellowship  
Program, or company financed evening  
courses.

**WESTERN LIVING AT ITS BEST  
"IN THE VALLEY OF THE SUN"**

Modern Inexpensive Housing

Send resume to:  
A. E. Manning

Engineering and Scientific Personnel

**GOODYEAR AIRCRAFT**

LITCHFIELD PARK  
PHOENIX, ARIZONA

Similar opportunities available in our  
Akron, Ohio Laboratory



# A new Bendix Radio Engineering Building

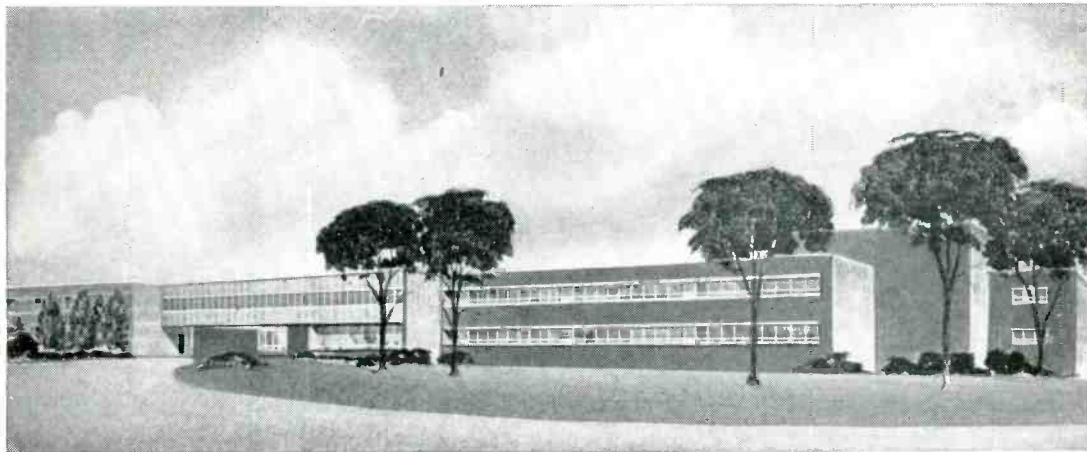

## AND WHAT IT CAN MEAN TO YOUR FUTURE!

**ELECTRONIC ENG.  
PHYSICISTS  
MECHANICAL ENG.**

Our new Engineering Building is one manifestation of our continuing rapid growth. Yes, we are expanding both our government and commercial business. This means you can step up your engineering career *fast* with us! You'll benefit from top salaries . . . a secure future . . . placement at highest level of your capabilities . . . pleasant living in beautiful residential area. Simply drop us a postal card, briefly stating your education and experience. We'll act fast . . . and confidentially!

*Do research, development & design in these fields:*

- COMPUTERS
- RADAR (Fixed, Airborne, Mobile)
- AIRBORNE COMMUNICATIONS & NAVIGATION EQUIP.
- MISSILE GUIDANCE SYSTEMS
- MOBILE COMMUNICATIONS
- AUTO RADIO
- MICROWAVE DEVELOPMENT
- TRANSISTOR APPLICATIONS
- TECHNICAL WRITING
- RADAR FIELD ENG.

*Move AHEAD with Bendix!*



Address: Personnel Manager, Dept. E

# Bendix Radio

DIVISION OF  
BENDIX AVIATION  
CORPORATION

Baltimore 4, Maryland

# PHILCO *wants* ELECTRONIC ENGINEERS

Who Really Have Something  
to Crow About . . .

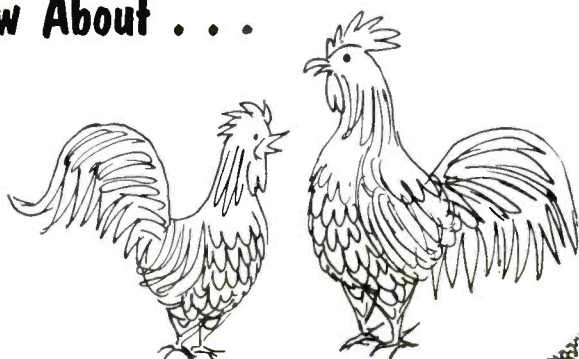

FIRST IN INCOME AND EMPLOYEE BENEFITS

Although a few openings exist for men at the Junior Level, our present need is for men of PROVEN performance . . . men who are tops in their field of Design, Maintenance and/or Instruction of others in Communications, Radar and Sonar Equipment.

If YOU have something to really crow about and seek challenge and opportunity to insure as bright a future as your past suggests, write now for ALL the details as set forth in our new, full color 22 page brochure on —

*"First* **PHILCO TECHREP**  
*In Employment Opportunities"*



**TECHREP  
DIVISION**

Department 13  
22nd & Lehigh Ave.  
Philadelphia 32, Pa.

FIRST

IN ELECTRONIC FIELD SERVICE

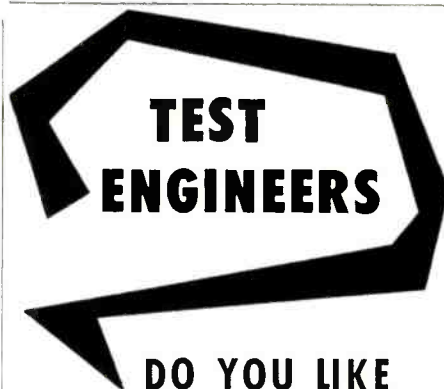

**DO YOU LIKE  
YOUR ENVIRONMENT?**

Investigate the Environment created at AC for its Advanced Development Programs on Missile Guidance and Aircraft Fire Control Systems.

### OUR ENVIRONMENTAL LABORATORY

is one of the most Versatile Laboratories in the country and is in the process of a Major, Permanent Expansion.

Men hired will enjoy working with the finest of test equipment and facilities, together with top men of the field.

We are currently engaged in the following Types of Test Activities:

- VIBRATION TESTING
- COMPLEX WAVE ANALYSIS
- LOW TEMPERATURE—ALTITUDE
- HIGH TEMPERATURE
- RELIABILITY EVALUATION
- INSTRUMENTATION

Write Mr. J. Heffinger,  
Supervisor of Salaried Personnel

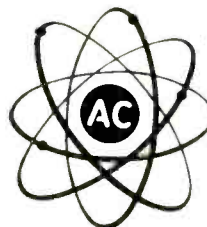

**THE  
ELECTRONICS  
DIVISION**

**GENERAL MOTORS CORP.  
MILWAUKEE 2, WIS.**



**Engineers • Physicists**

# On The Way UP!

● Planned progress is the key to success for an individual as well as a business.

● Here at BURROUGHS we know where we are going . . . our course is charted and, like such advanced Intercontinental Ballistic Missiles as ATLAS and TITAN, we too are on the way up!

*More than 1,600 people and in excess of 200,000 square feet of working space in our four centers, located in the Paoli area, testify to our progress since 1954.*

● If YOU are an Engineer or Physicist . . . ON THE WAY UP . . . why not make the ascent with us in the creation and development of the advanced new computer techniques which will be required to control the course, speed and altitude of such Intercontinental Ballistic Missiles as ATLAS and TITAN as they are propelled out into space beyond the earth's atmosphere?

● Sage . . . ICBM . . . are just a few of the many government projects under way at BURROUGHS RESEARCH CENTER where, and equally important, untold time and creative effort is also being spent by our scientists on new and better ways to improve the business machines which have given BURROUGHS the right to use the slogan:

## **THE Foremost Name IN COMPUTATION**

### **To Meet Tomorrow's Challenges Today**

*Burroughs Invites Inquiries from Those Qualified As:*

- ELECTRICAL ENGINEERS
- MECHANICAL ENGINEERS
- MATHEMATICIANS
- ELECTROMECHANICAL ENGINEERS
- MECHANICAL DESIGN ENGINEERS
- PHYSICISTS

*. . . in the following fields — Control Computers, Pulse Circuitry, Digital Computers, Optical Devices, High Speed Mechanisms, Guided Missiles, Solid State Circuitry, Electronic Packaging, Electrographic Recording Devices, Printed Circuit Development.*

**Write or Telephone M. E. JENKINS, Placement Manager**



*Near Historic Valley Forge*

# RAYTHEON

A  
D  
A  
R

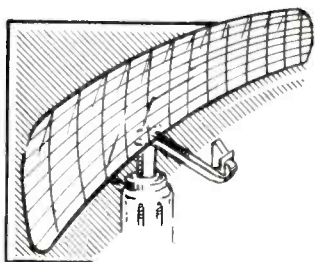

- ... guides 7 of 10 ocean-going ships around the world
- ... guards our freedom — arctic DEW line, Navy picket subs, long-range bombers
- ... controls civil air traffic
- ... forecasts the weather

The Radar Department of the Wayland Laboratory has several new and urgent development programs. You can enhance your professional stature by contributing to ours.

## SERVO ENGINEERS

with experience in closed-loop control systems, analogue computers or magnetic amplifiers desirable.

## MECHANICAL ENGINEERS

with design experience in structures, mechanisms, hydraulic components, heat transfer, or packaging.



Send brief resume to:  
Radar Professional Personnel, 242—Raytheon Mfg. Co., Wayland, Mass.

HOMING IN AT  
**VISIBILITY ZERO**

BY NIGHT OR BY DAY, IN ALL KINDS OF WEATHER, MILITARY AIRCRAFT—SUCH AS THE CHANCE VOUGHT "CRUSADER"—RELY ON PACKARD-BELL C-N-1\* SYSTEMS TO GUIDE THEM HOME

## LONG-RANGE JOB OPPORTUNITIES NOW OPEN

At Packard-Bell, designers and producers of many complex IFF, radar and missile equipments, no job is too tough for our select group of advanced electronic and mechanical engineers to tackle. Packaging problems, too, such as the \*Communications-Navigation-Identification System used by the Chance Vought "Crusader," have been successfully met—and conquered. Top paying positions are now available for electronic and mechanical engineers, design draftsmen, mechanical and electrical technicians. Paid vacations—overtime—sweeping hospital benefits for you and your family. Packard-Bell's future is your future—and a brilliant one it can be—with the West's most aggressive electronics design, development and production facility.

### WRITE TODAY!

Send complete background resume to Dr. George J. Mueller, Chief Engineer  
Technical Products Division

Packard-Bell

TECHNICAL PRODUCTS DIVISION



12333 WEST OLYMPIC BOULEVARD  
LOS ANGELES 64, CALIFORNIA

## NATIONAL REACTOR TESTING STATION

Career Opportunities

for: **ELECTRICAL ENGINEERS**  
**ELECTRONIC TECHNICIANS**

- Phillips Petroleum Company will soon be operating seven reactors, and excellent openings exist in Development, Research, Operations and Maintenance.
- Opportunities also exist for Physicists, Chemists, Metallurgists, and Chemical and Mechanical Engineers at all levels of academic training.
- Enjoy the benefits of a rapidly expanding organization, opportunities for graduate and undergraduate study, and the finest of modern plant facilities, as well as superb trout fishing and Sun Valley skiing.

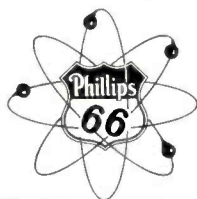

Write to: Atomic Energy Division  
Phillips Petroleum Company  
Box 1259, Idaho Falls, Idaho  
Att'n: Personnel Administration

# An Open Interview with an Engineer

at Westinghouse Electronic  
Tube Division, Elmira, N. Y.



Today's engineering applicants are interested not only in their opportunities for growth and advancement in their chosen fields, but they also carefully consider the community and its facilities for pleasant living.

Most young engineers today are married . . . many with small families already established. They usually ask about housing, schools, churches, community organizations and outdoor activities. Almost always they want to look the town over to make sure it's an attractive healthful place to raise a family.

Here is part of a typical interview as we see it at the Westinghouse Electronic Tube Division, Elmira, N. Y.

(Interviewer) "We're glad you could arrange to come to Elmira to talk over our professional openings".

(Applicant) "I've enjoyed it so far".

(I.) "Good! Looking over your resume, I see that you've been primarily concerned with circuit design problems since you got your degree in '52".

(A.) "That's right. While the work has been quite interesting, I feel that I'd like to get into something a little different—something that will make use of my circuit experience and also broaden my background".

(I.) "Do you want to stay in the equipment design field?"

(A.) "Well, no, not necessarily, I'd like to explore some aspects of tube design if you think I might fit in".

(I.) "I think so. It's been our experience that anyone with an E.E. degree has the background for learning design rapidly. This is even more true of those engineers who have taken our fundamentals of vacuum tubes course, here in Elmira. This, along with your experience, should make you highly competent rather quickly".

(A.) "Where would I fit into the Tube Division, then?"

(I.) "There's a possibility in each of several sections—Camera Tube Design, Application Engineering, Receiving Tube Design, and Equipment Development where our own manufacturing and test equipment is designed, to mention only a few. We will arrange interviews with the heads of those sections so you can go into detail of our work in each. Is that okay?"

(A.) "Sounds good".

(I.) "Do you have any other questions that can be answered while the interviews are being arranged?"

(A.) "Is there a Pension and Insurance plan?"

(I.) "You bet! Two of the best plans I've seen. Here are short, quickly read booklets describing them. You will find that they cover most every contingency. Incidentally, the life insurance and pension plan goes into effect the day you start to work".

(A.) "How about housing?"

(I.) "It's pretty good. We've been able to find suitable quarters fairly quickly in the past year or so. To help you get located, we'll run an ad in the local papers for you—Elmirans have found that Westinghouse engineers make desirable tenants. There are some good real estate buys available too. Do you go in for outdoor activities?"

(A.) "Whenever possible. Fishing and golf are my favorites. Haven't had much time for either since living in the big city".

(I.) "There's good trout and bass fishing here—both in the streams and the lakes. And \$30. pays your annual greens fees at the 18 hole course about a mile from the plant. There are lots of other activities that might be of interest—chess, little theatre, hiking, bridge, soft ball teams, management club, bowling, bird watching, sailing, community concerts, and others—lots of choice".

(A.) "How about Churches?"

(I.) "I don't know your choice, but I'll bet you'll find it! We have more than 50 churches within a radius of 5 miles. There are excellent Sunday Schools, too".

(A.) "How about the schools here?"

(I.) "Several beautiful schools have been completed recently to take care of the increasing school population. Your youngsters would get the benefit of fine modern schools—and both the public and parochial schools maintain high scholastic standards".

(A.) "Sounds good so far—now about pay".

(I.) "A very important item! After you have had your interviews, I'll get together with those men you talked with and the Wage and Salary Administrator. The contributions we can expect from you, your estimated potential and your relative spot in the organization will be translated into a monthly salary. That will be included in

our offer-letter which you will receive soon after your visit. You will find our salaries are very competitive".

(A.) "Any reasonable chance of getting more?"

(I.) "Naturally. There'll be at least a 3% general increase each Fall for the next three years, quarterly cost of living adjustments and periodic performance reviews to determine merit increases. There is nothing 'hit or miss' about our salary program. Promotions are very possible too, in a growing, dynamic organization like Westinghouse".

(A.) "Well—that sounds encouraging—and quite challenging too. It seems to me you've covered all my questions very well".

(I.) "Here, let me pin this identification badge on your lapel—and we'll go through the plant and offices on the way to your talks with each of the men with whom appointments have been made. I'll take you to the first one, and he'll 'pass you along' the chain. After the last interview, you will come back to my office for any further questions. We're aware of your travel arrangements—so we shall see that you make your plane home. Let's go meet the Engineering Manager".

If you are interested in advancing your career in the electronics field, we invite you to submit information which may lead to an interview with us at our Tube Division. Our rapidly expanding plants in both Elmira and Bath, N. Y., will give you an opportunity to find satisfaction and challenge in important branches of engineering.

The Elmira Bath area is a beauty-spot in upstate New York, located at the gateway to the Finger Lakes . . . just the kind of a community you and your family will enjoy.

At present we have opportunities for engineers in Tube Design and Development for Microwave Tubes, Receiving Tubes, Pickup Devices, Power Tubes, Cathode Ray Tubes; Application Engineering, Electrical Equipment Design, Manufacturing Engineering, and in Glass Engineering.

In submitting information concerning your background, phone collect to Westinghouse Electronic Tube Division, Elmira 9-3611 and ask for Robert M. Jarret in Department Q 21. (After 5 p.m. or week ends phone collect Elmira 9-2360). If you prefer, write a letter attention above person and Dept., giving basic information, and ask any question you wish.

REEVES

# ELECTRONIC FIELD SERVICE ENGINEERS

GRADUATES OR EQUIVALENT EXPERIENCE

Now read this!

Men with  
experience in

- Gun Fire Control
- Naval or Ground Radar
- Computers

are offered factory training at an excellent beginning salary.

Full per diem subsistence while on assignment. Free Hospitalization and Surgical benefits for you and your dependents.

Reeves, one of the foremost designers of Missile Guidance and Electronic Control Systems, as well as the REAC® Computer, requires additional Field Service Engineers.

Here is an opportunity to join an expanding organization with an exceptional reputation in the Electronic Field.

PRESENT OPENINGS ALSO IN THE RESEARCH

AND DEVELOPMENT SECTION OF REEVES

FOR ELECTRICAL ENGINEERS ARE AVAILABLE IN:

- |                           |                    |
|---------------------------|--------------------|
| • Industrial Automation   | • Analog Computers |
| • Guided Missile Controls | • Inertial Systems |
| • Gyroscopies             | • Radar            |
| • Transistor Circuits     | • Gun Fire Control |
| • Components              | • Nucleonics       |

ASSIGNMENTS in the United States and Overseas Areas. A few assignments with New York City as home base are available.

Interviews can be arranged in either New York City or Mineola, L. I. Daily, until 6:30 P. M.

## REEVES INSTRUMENT CORP.

SUBSIDIARY OF DYNAMICS CORP. OF AMERICA

215 East 91st Street, N. Y.  
Near 3rd Avenue  
Call Mr. Carew, TR 6-6222

East Gate Boulevard  
Roosevelt Field, Mineola, L. I.  
Call Mr. Waters, Pioneer 6-8100

### Design and Engineering Opportunities for

**Electronic Engineers      Design Engineers**  
**Electrical Engineers      Field Engineers**  
**Project or Systems Engineers**

Kollsman's expansion in the airborne equipment field has created a need for additional engineers and electro-mechanical designers, and offers unusual scope to alert, capable and enthusiastic professional men. For engineers, a degree in Mechanical Engineering, Electronic Engineering or Physics is necessary, plus experience or a strong interest in airborne instrumentation or allied fields.

America's finest aircraft instruments are designed at Kollsman, where the congenial atmosphere and modern facilities contribute to an environment in which a man can do his best work.

Please submit resumes to T. A. DeLuca



**kollsman** INSTRUMENT CORPORATION

60-08 45th AVENUE, ELMHURST, NEW YORK • SUBSIDIARY OF Standard COIL PRODUCTS CO. INC.

### DIGITAL ENGINEERS

for Long-Range Programs  
Airborne Control Applications

Challenging assignments with opportunity to carry your ideas through to final hardware and operational flight testing in:

- Computer Organization
- Logical Design
- Advanced Circuit Designs
- Laboratory Development
- Packaging and Reliability

*Forward confidential resume  
No reference contact without  
your permission.*

Manager of Technical Personnel Dept. 674

**ARMA**

Division of  
American Bosch Arma Corporation  
Roosevelt Field, Garden City  
Long Island, N. Y.

An employment advertisement in this EMPLOYMENT OPPORTUNITIES section will help you find the engineers you need. It's an inexpensive, time saving method of selecting competent personnel for every engineering job in the electronic field.

ON DECEMBER 2, 1942  
 MAN ACHIEVED HERE  
 THE FIRST SELF-SUSTAINING CHAIN REACTION  
 AND THEREBY INITIATED THE  
 CONTROLLED RELEASE OF NUCLEAR ENERGY

## Ingredients of Leadership

MAJOR REACTORS		ZERO POWER REACTORS	
CP 1 First Chicago Pile 1942	CP 2 Graphite-Research 1943	ZPR I Mark I Nautilus 1950	ZPR II Savannah River 1952
CP 3 D <sub>2</sub> O-Research 1944	Hanford-design 1944	ZPR III Fast Assembly 1955	ZPR IV Neutron Source 1953
CP 4 Fast Breeder— EBR I 1951	CP 5 D <sub>2</sub> O-Research 1954	ZPR V "Half-fast" Pile 1956	ZPR VI Fast Assembly 1957*
CP 6 Savannah-design 1954	CP 7 H <sub>2</sub> O Boiling Power 1956*	ZPR VII Thermal Assembly 1957*	
CP 8 Fast Breeder— EBR II 1958*	CP 9 Argonne "Package" 1958*	*Estimated	
CP 10 Isotope Producer-design 1953	CP 11 Argonaut-teaching 1956	BOILING REACTOR EXPERIMENTS	
CP 12 H <sub>2</sub> O Boiling- parametric 1958*	Borax I safety 1953	Borax II pressurized 1954	Borax III power 1955
		Borax IV fuel test 1956	

... a unique combination of basic, fundamental and applied research ... administration by scientists for scientists ... atmosphere and facilities conducive to creativity ... a dedication to knowledge of interest and significance to the individual ...

... the best of academic and industrial research practices ... effective inter-disciplinary approach to major problems ... a penchant for solving unsolvable research and engineering problems ...

... opportunity for unlimited professional growth and expression ... minimum direction ... equivalent salary recognition for the individual who does not assume administrative responsibilities ...

Now expanding our staff for the first time in a number of years. Scientists and engineers who hunger for intellectual and creative satisfaction are offered an extraordinary opportunity to become associated with the challenge that is offered at ...

*Argonne*  
 NATIONAL LABORATORY

Professional Personnel Office  
 P.O. Box 299 • Lemont, Illinois

ENGINEERS, BS, MS, PhD

# COMPUTER ENGINEERING POSITIONS

Now open at **General Electric's**

New Industrial Computer Section

at Palo Alto, Calif., Schenectady, N. Y. and another location (to be announced shortly)

Immediate Opportunities on **ERMA COMPUTER**

(Electronic Recording Machine Accounting)

**and many other general purpose and special application computers, both digital and analog**

Openings for

PHYSICISTS • ELECTRONIC ENGINEERS • MECHANICAL ENGINEERS  
ELECTROMECHANICAL ENGINEERS • NUMERICAL ANALYSTS

ERMA IS REVOLUTIONARY IN CONCEPT AND EXECUTION

- ... First industrial data processing system designed to solve entire checking account bookkeeping.
- ... Originally conceived by Bank of America and developed to the bank's specifications by Stanford Research Institute.
- ... Now being product-designed for manufacture, by General Electric, making optimum use of transistors.

Please send your resume to C. E. Irwin **INDUSTRIAL COMPUTER SECTION**

## GENERAL ELECTRIC

Building 32, Schenectady, N. Y.

## ELECTRONICS

REPORT

and

SPECIFICATION

## WRITER

Experienced in preparation of qualification reports and maintenance manuals. Must be familiar with MIL & AN specifications. Applicant with limited experience will be considered.

Excellent future. Many important and desirable benefits. Ultra-modern plant. Suburban area.

## CHATHAM ELECTRONICS

Division of Gera Corp.

Route 10, Livingston, N. J.

Phone: DI 9-0648 or  
Livingston 6-1100

## Goodyear Atomic Corporation

ENGINEERS  
and  
PHYSICISTS

M.S. — Ph.D.

Several engineers and physicists with extensive background in the fundamentals of analytical and laboratory research and development are needed for activities involving:

Computers, automatic controls, electro-mechanical designs.

Electronic circuit design and analysis. Development and application of transistor circuitry. Servomechanisms and control system analyses. Instrument design—electronic and pneumatic. Mass spectrometer development.

Send comprehensive resume indicating qualifications, minimum salary requirement and availability for interview. All replies held in strict confidence.

## GOODYEAR ATOMIC CORPORATION

EMPLOYMENT DEPARTMENT U  
BOX 628, PORTSMOUTH, OHIO

## opportunities in NEW HAMPSHIRE for a few ambitious, grad. ENGINEERS

electronics—general  
electrical—ind. control  
time and motion  
sales—electronics test  
equipment

ESTABLISHED mfg. needs competent men who seek challenging broad-gauge work in small but progressive company. No specialists—only well rounded men acceptable.

**Northeastern Engineering, Inc.**  
Manchester, N. H.

## EMPLOYMENT PROBLEM?

When you are in need of specialized men for specialized jobs, contact them through an employment ad in this publication.



# ENGINEERS!

*Let's talk turkey*

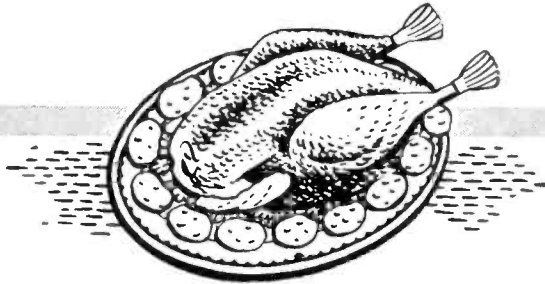

*Do you eat and sleep electronics?*

*Do you try to keep abreast of the advancements in the electronics industry?*

*Do you want to develop your own talent in a rapidly expanding electronics industry?*

*Then let's talk about HOOVER . . . Hoover Electronics Company, that is!*

Hoover Electronics Company in Baltimore has prospered because a group of engineers succeeded in establishing responsible engineering positions with an unlimited future. Naturally, these engineers became well known in the electronics research and development field. *There could be a spot on this team for you!*

The Hoover Company, with its world-wide position and reputation in the manufacture of electric appliances, dates back to 1908. To supplement its vast field of manufacturing The Hoover Company selected this group of specialized engineers and they are

known as the Hoover Electronics Company—a subsidiary of The Hoover Company.

The home plant of Hoover Electronics Company in Baltimore will be a 110,000 sq. ft. daylight plant with all modern conveniences including air conditioning, modern restaurant, and other conveniences to provide the ultimate in working comfort.

We are engaged in long range growth insured by a substantial backlog of contracts and a staff of electronics engineers with national prestige. This combination of work and skill provides an atmosphere conducive to your maximum development. This development will carry with it optimum advancement with commensurate monetary reward.

And now it is your turn to "talk turkey"—if you can answer "yes" to the above questions, forward a brief summary of your background experience to Personnel Director —

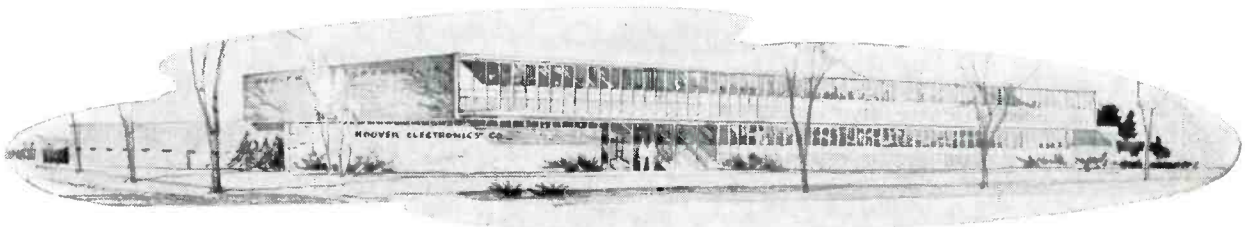

**HOOVER ELECTRONICS CO.**  
3640 WOODLAND AVE. • BALTIMORE 15, MD.

# AVION

DIVISION  
ACF Industries, Inc.

*Continues it's policy of  
Dynamic Leadership  
in Electronic Development*

Challenging Research &  
Development Positions For:

## ELECTRONIC ENGINEERS

Airborne Electronic & Missile Systems  
Equipment

- Analog Computers
- Aircraft Navigation Aids
- Magnetic Amplifiers
- Microwave
- Magnetic Storage Devices
- Radar
- Infra-Red
- Electro-Optics

Openings At All Levels  
From Junior to Supervisory

### Field Service Representatives

to represent AVION at permanent field locations. Work will consist of design, maintenance and liaison with the customer. **QUALIFICATIONS:** Experience in one of the following: Radar; Computers; Fire Control Systems; Servo-mechanisms; Magnetic Amplifiers.

Top Per Diem • Travel Allowances

Call or write:

Technical Employment Dept.

Every inquiry will be answered

### Tuition-Paid Educational Plan

AVION encourages advanced education. Our liberal educational benefits plan enables qualified employees to further their education either by taking courses leading to a degree, or courses pertinent to their assignments.

### Location ideal for working & living

Comfortable, convenient living provides optimum conditions to bring out the best of your capabilities. Suburban Paramus, N. J., offers countrified, neighborly residential communities nearby . . . yet it is only 15 minutes from G. Washington Bridge and New York City's superb cultural, educational and entertainment centers.

### You are invited to join a leader

Move to the forefront of your field . . . our important position in Electronics assures you of challenging assignments on advanced projects . . . rapid recognition of your accomplishments . . . as well as high salary supplemented with many company-paid benefits.

# AVION DIVISION

ACF INDUSTRIES, INCORPORATED

Route 17, Paramus, New Jersey Colfax 1-4100

Our Virginia Plant: North Pitt Street, Alexandria, Va.

## ENGINEERS & PHYSICISTS —

- small expanding company
- engineer owned and operated
- location—Cambridge, Massachusetts

GEL offers excellent opportunities to individualists who desire professional growth, responsibility, and good salary. Positions now available at all levels for electronic and mechanical engineers in the following fields:

- |                 |                      |
|-----------------|----------------------|
| Servos          | Receivers            |
| Antennas        | Countermeasures      |
| Microwaves      | Electronic Packaging |
| Pulse Circuitry | Pedestal Design      |

For further information—contact: L. Billig, Chf. Eng.

## GENERAL ELECTRIC LABORATORIES, INC.

18 Ames St.

UN 4-8500

Cambridge, Mass.

## NEED ENGINEERS

Place an "Engineers Wanted" advertisement in this EMPLOYMENT OPPORTUNITIES section. It's an inexpensive, time saving method of selecting competent personnel for every engineering job in the electronic industry. The selective circulation of ELECTRONICS offers you an opportunity to choose the best qualified men available throughout the industry.

# COMPUTER

Applications  
and  
Development

## ENGINEERS

## COMPUTING SERVICES

Engineering & Scientific Computation

Analog  
Digital

## COMPUTERS SYSTEMS DEVELOPMENT

## DEVELOPMENT

Analog and Digital

Systems analysis and synthesis  
Logical organization  
Circuit design

These are full time positions offering fascinating and varied work and educational benefits for graduate study. Contact:

Excellent openings also available in many areas of Electrical Engineering both in Chicago, and Tucson Arizona.

J. A. Metzger

## ARMOUR RESEARCH FOUNDATION

of Illinois Institute of Technology  
10 West 35th St. Chicago 16, Illinois

## LIAISON ENGINEER

for MICROWAVE SYSTEMS  
with GENERAL ELECTRIC  
in Utica, N. Y.

Man needed must be capable of directing and coordinating the design and development of microwave projects on military airborne electronic systems.

Salary to \$11,000  
Commensurate with experience

Write in  
complete confidence to:

Mr. John Sternberg, Dept. 842  
Light Military  
Electronic Equipment Dept.

**GENERAL ELECTRIC**

French Road, Utica, N. Y.

## Manufacturer's Representatives

WANTED

Ultradyne Engineering Labs specializing in design, development and manufacture of electro-mechanical transducers for measurement and control.

Manufacturer's representatives are needed in the following areas: New England, South-eastern States, Pennsylvania, Ohio and entire Middle West. For further information please contact:

L. E. Shaw

Ultradyne Engineering Labs, Inc.  
P. O. Box 8007 Albuquerque, New Mexico

✓ **ELECTRONICS TEST EQUIPMENT  
ENGINEERS**

✓ **PRODUCTION ELECTRONICS PROJECT  
ENGINEERS**

Phone

**EMERSON-ELECTRIC**  
OF ST. LOUIS

Collect...!  
for information about

*Exceptional career opportunities  
created by vital new projects and  
planned long-range expansion in  
our Aircraft Division*

Wherever you are, we'd like to talk to you personally. Telephone us ... collect ... from the comfort and privacy of your own home, for a friendly and informal discussion about your future, and the unprecedented opportunities now awaiting you at EMERSON-ELECTRIC.

EMERSON-ELECTRIC is a medium size company (5000 employees, 700 engineers), and a national leader in the design, development and production of supersonic airframe sections, missiles, electronic fire control systems and aircraft components. You'll be an important part of a team working on bombers which will fly at twice the speed of sound, plus other aircraft of the next decade.

Our Commercial Division, established in 1890, produces a comprehensive line of fans, motors, air conditioners and power tools. This perfect balance of aircraft, electronic and consumer production assures you of security and permanency in your career at EMERSON.

We're ideally located in a pleasant, suburban residential area, and our working atmosphere is relaxed, informal—and efficient.

Benefits include unusual salary arrangements, 48-hour week, rapid advancement, fully paid transportation and moving expenses to St. Louis, group insurance and pension plan, and many others.

This is opportunity—awaiting your call. Let us hear from you. Or if you prefer, write us and include a brief resume of your education, business background and approximate salary requirements.

**AIRCRAFT DIVISION**

**EMERSON ELECTRIC**

8100 W. FLORISSANT



ST. LOUIS 21, MO.



**...CALL**

**RON MIDDLETON  
or  
ANDY DEPKE**

any Wednesday evening between  
8-10 p. m. Eastern Daylight Time  
7-9 p. m. Central Daylight Time  
6-8 p. m. Rocky Mountain Daylight Time  
5-7 p. m. Pacific Daylight Time  
at COLfax 1-3484, ST. LOUIS, MO.

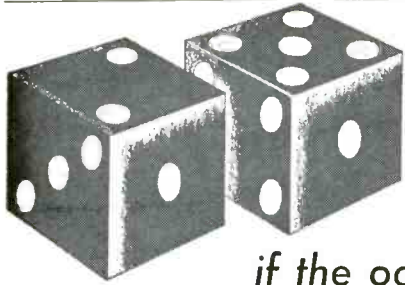

# GAMBLE?

sure . . .

if the odds are in **YOUR** favor . . .

**DECISION/INC**—nationwide specialists in recruitment of engineering personnel—have an active and enviable record in developing job opportunities for men who want bigger salaries and a chance for greater personal achievement.

**DECISION/INC** is retained by more top-ranking firms thruout the nation than any other organization to *find the right man for each job.*

This confidential service costs *you* nothing.

It takes **TIME—MONEY—EFFORT** to improve your job situation. If you are an engineer or scientist, particularly in the **ELECTRONIC—AERONAUTICAL** or **GUIDED—MISSILE** field, **DECISION/INC** will do this *quickly, effectively at no cost to you.*

**HOW?** After a study of your outlined objectives, our placement specialist develops a plan "tailor-made" for you—which includes a resume of your experience . . . and then a review by selected companies leading to confidential interviews at *your* convenience and *our* client's expense.

**NOW is the time for DECISION!**

All *you* do *Now* is . . . send us your name, home address, job interest or title. We take it from there.

Write or phone:

**OLIVER P. BARDES, President—DECISION/INC**  
1450 FIRST NATIONAL BANK BUILDING  
CINCINNATI 2, OHIO GARfield 1-1700

Publishers of the authoritative **ENGINEERS' JOB DIRECTORY**

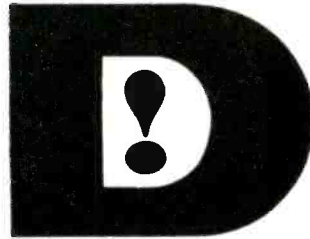

## TECHNICAL RESEARCH GROUP

Senior Level Openings  
in  
**Reactor Shielding**  
**Microwaves**  
**Solid State Physics**  
**Radar Systems**

Several positions are open in Technical Research Group's permanent staff. Qualified scientists can choose from among present programs on radar systems and components, nuclear resonance, electro-magnetic theory, nuclear reactors, and airborne reactor shielding. These and other programs of study and development continue to provide opportunities for diversified work.

Organized in 1953, TRG now has a full time technical staff of fifty, one-third of whom are at the PhD level. Offices, laboratories, and model shop are centrally located in New York City.

Company employee policy encourages continued education at nearby universities and provides for liberal vacation, holiday, and sick leave benefits in addition to free medical, hospital, and life insurance.

Immediate opportunities in **AIRBORNE**

## electronic countermeasures

Permanent positions of major responsibility. Work from initial concept to finished product. Associate with recognized leaders in the electronics field. Ability rewarded. Excellent employee benefits.

Immediate openings in Electronic Division:

**senior  
engineers**

— to direct development, layout and design through all phases to finished product. Prefer 8 to 12 years experience.

**design  
engineers**

—for development and design of electronic circuits to MIL Specifications. 4 to 8 years experience.

send detailed resumé to:

### Thompson Products, Inc.

Manager, Technical Placement 1-E

6410 Cedar Avenue • Cleveland 3, Ohio

For more than 55 years, Thompson Products has been a leader in creative engineering and precision manufacturing for aircraft, automotive and other diversified industries.

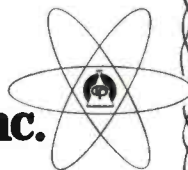

TECHNICAL  
RESEARCH  
GROUP

17 UNION SQUARE WEST  
New York 3, New York • WATkins 4-4363

# ELECTRICAL ENGINEERS

Challenging positions open for high caliber Electrical Engineers to work in interesting research and development programs in instrumentation and circuitry.

We offer an opportunity to do non-routine research with some of the leading engineers in the field. This is an opportunity to be creative and experience satisfaction of accomplishment and contribution.

Excellent employee benefits, good salary, and working conditions. Please send complete resume to:

**E. P. BLOCH**  
**ARMOUR RESEARCH FOUNDATION**  
 of  
**ILLINOIS INSTITUTE OF TECHNOLOGY**  
 10 West 35th St.  
 Chicago, Illinois  
 Opportunities also available in  
 TUSCON, ARIZONA

# COMMUNICATIONS ENGINEERS and TECHNICIANS

EXCELLENT SALARIES  
 MINIMUM PREREQUISITES

**ENGINEER** EE Graduates with 3 years experience  
**TECHNICIAN** 2 years technical school in communications and 3 years experience.

Require installation adjustment and maintenance experience with communication receivers and associated terminal equipment. Also, men with similar experience with high-powered transmitters, antennas, transmission lines.

Must be willing to travel in United States and Overseas.

Page Communication Engineers, Inc.  
 710 Fourteenth St., N.W., Washington 5, D.C.

# SYSTEMS ENGINEERS

FOR ADVANCED WEAPONS SYSTEMS

Join a team of engineers and scientists already working on stimulating assignments in the challenging field of Guidance and Control.

Carry your ideas through to final hardware and operational flight testing.

Perform creative system studies and instrumentation.

Apply the latest technological knowledge in such areas as:

INERTIAL GUIDANCE • DYNAMIC ANALYSIS  
 BALLISTICS RESEARCH • TELEMETRY

Please forward confidential resume. No reference contact without your permission  
 Manager of Technical Personnel, Dept. 674



Division American Bosch Arma Corp.  
 Roosevelt Field Garden City, L. I., N. Y.

# Electronic Technicians

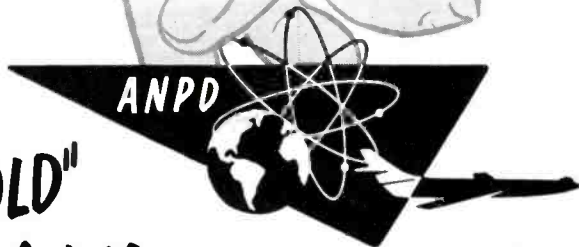

**"TAKE HOLD"**  
 Of your future  
 in the Atomic Energy Field!

Our organization offers unlimited possibilities for personal development and job advancement.

We seek technicians to assist in the development and prototype manufacture of electronic controls and instrumentation for the nuclear propulsion of aircraft. If you have military or civilian training and experience in electronics, fill out the coupon below and rush it to us at once.

AIRCRAFT NUCLEAR PROPULSION DEPARTMENT

**GENERAL ELECTRIC**

P.O. BOX 132 CINCINNATI 15, OHIO

Dear Mr. Hoopes:  
 I'm interested in full details about an opportunity at General Electric as an Electronic Technician. Please send me more information. I understand all replies are held in strictest confidence.

Mr. Robert H. Hoopes, Personnel Section, A.N.P.D.  
 General Electric Co., P.O. Box 132  
 Cincinnati 15, Ohio

NAME \_\_\_\_\_  
 STREET \_\_\_\_\_  
 CITY \_\_\_\_\_ STATE \_\_\_\_\_

## ELECTRONIC TECHNICIAN EXPERIENCE *Check* LIST

Check items listed below indicating approximate months or years of Electronic Technician experience.

	Yrs.	Mos.		Yrs.	Mos.
<input type="checkbox"/> High School	_____	_____	<input type="checkbox"/> Printed Circuit Dev. & Fabrication	_____	_____
<input type="checkbox"/> Correspondence School	_____	_____	<input type="checkbox"/> General - Laboratory Development	_____	_____
<input type="checkbox"/> Technical School	_____	_____	<input type="checkbox"/> Test - Construction	_____	_____
<input type="checkbox"/> Military Service Schools	_____	_____	<input type="checkbox"/> Nuclear Reactor Controls	_____	_____
<input type="checkbox"/> College	_____	_____	<input type="checkbox"/> Servo-Controls	_____	_____
<input type="checkbox"/> Math.-Algebra-Trig. Calculus	_____	_____	<input type="checkbox"/> Radar - Sonar - Loran	_____	_____
<input type="checkbox"/> Electrical Drawing	_____	_____	<input type="checkbox"/> Radio Communication Maintenance	_____	_____
<input type="checkbox"/> Radio & TV Servicing	_____	_____	<input type="checkbox"/> I.F.F. - Fire Control Systems	_____	_____
<input type="checkbox"/> Testing & Trouble Shoot Electronic Equipment	_____	_____	<input type="checkbox"/> Magnetic & Dielectric Circuitry	_____	_____
<input type="checkbox"/> Fabricate - Assemble - Wire Electronic Equipment	_____	_____	<input type="checkbox"/> Most Specialized In _____	_____	_____



# ENGINEERS

*Brown Instruments Division*

OFFERS EXCELLENT OPPORTUNITIES IN

**RESEARCH — DESIGN and DEVELOPMENT  
APPLICATION and SYSTEMS ENGINEERING**

Openings for ELECTRICAL ENGINEERS, MECHANICAL ENGINEERS, PHYSICS MAJORS, in all phases of Industrial Instrumentation, including Automatic Data Processing and Nuclear Reactor Controls.

Opportunities permit designing and working with equipment from the initial ordering through development to actual operational checkout. These positions offer excellent potential for men with ambition and inventiveness. Openings are with a separately functioning division which is expanding rapidly to meet present trend in Automatic Data Processing and Reactor Control areas. Positions provide prestige and benefits offered by one of the leaders in INDUSTRIAL AUTOMATION.

CONTACT OUR REPRESENTATIVE

MR. D. R. GARVEY

**HONEYWELL  
BROWN INSTRUMENTS**

Wayne & Windrim Avenues

Philadelphia 44, Pa.

# ENGINEERS! SCIENTISTS!

Is your advancement keeping pace with your ability?

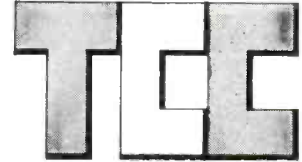

If you are not pleased with your present position . . . if you just don't seem to be doing the type of work you like to do . . . then we suggest you contact us at once.

We represent clients who retain us to secure qualified technical personnel for their ever expanding research and engineering programs. TCC can help you find the position that will utilize your abilities to the utmost . . . as well as satisfy your salary requirements and location preference.

Our service is completely confidential with all contacts being made at your residence. There is no expense or obligation to you what so ever.

*Write, phone, or wire today for information which will put you "on your way" to the position of your choice.*

**TECHNICAL CAREER CONSULTANTS**

643 Tri-State Building  
432 Walnut Street, Cincinnati 2, Ohio  
Attention: Robert Adams

ELECTRONIC ENG.  
MECHANICAL ENG.  
**LARGE Company...**

Stability &  
Security

**SMALL Division...**

Recognition &  
Responsibility

***Bendix York offers both!***

As a young, expanding Division of Bendix Aviation Corporation, Bendix York is adding key personnel RIGHT NOW! . . . It's your chance to get specific assignments at the peak of the art in electronics and microwave development and design. Good salaries, all employee benefits, ideal suburban living conditions. Openings for Principal, Senior and Junior Electronic Engineers, Mechanical Engineers, designers and draftsmen.

Address: Dept. H

**Bendix**

AVIATION CORPORATION

**York**  
DIVISION

York, Penna.

YORK 47-2611

SENIOR LEVEL  
**ENGINEERS**

OR

**PHYSICISTS**

in Radar Systems  
Analysis

Require M.S. in E.E. or Physics. Minimum 3 years' experience in radar systems engineering. Involves analysis of very large scale ground radars which are radically new in concept, application and technique and involves electronic scanning and automatic data processing of radar returns.

Please forward complete  
resume to:

D. Crowley

**SYLVANIA**  
SYLVANIA ELECTRIC PRODUCTS INC.

100 First Avenue  
Waltham, Mass.

**DESIGN  
ENGINEER  
RADAR TRANSMITTER  
& MODULATOR**

Progressive company in Greater Philadelphia area is looking for an Electrical Engineer who desires to do creative work in a professional atmosphere. He should be experienced in the design of high power ground based radar transmitter and modulator equipment. Some experience with High Power Klystron transmitters is desirable. Company willing to pay relocation expenses to the engineer who can fill this vacancy. First class benefit program, along with top salary.

Just call collect

**Mr. Putney,**  
Moorestown, N. J.  
**BEImont 5-5000**  
Dept. V-10K

**ENGINEERS**

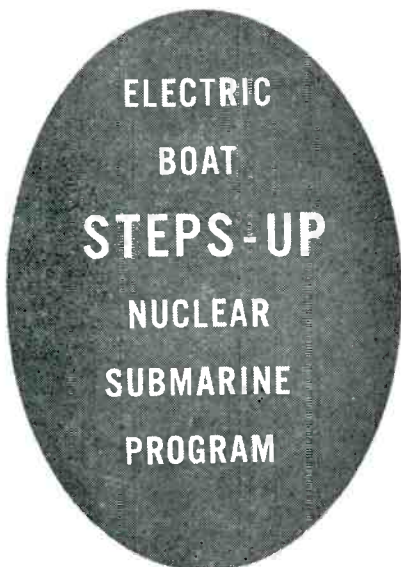

*offers unusual growth opportunities to engineers*

Two years ago, world attention centered on Electric Boat at Groton, Connecticut where scientific boldness harnessed the power of atomic energy to launch the Nautilus, which will soon be followed by its sister ship, Seawolf. Next to glide down the ways will be even more powerful versions . . . a third, fourth and fifth nuclear powered craft.

*Now, engineers who are cognizant of the implications of the Atomic Age are concentrating their interest on Electric Boat. The following opportunities exist for:*

- a) **Naval Architects**
- b) **Mechanical and Electrical Engineers** with 3 to 5 years experience in the application of mechanical and electrical marine power plant equipment.
- c) **Electrical and/or Mechanical Engineers** for basic design using analog computers, with respect to control systems, motor control circuits, power plant, speed and voltage regulators or fluid flow and thermodynamics. Familiarity with engine room and reactor plant electrical systems and controls desirable.

At Electric Boat your professional success is spurred by company sponsored courses at the plant, advanced study at leading universities, and by attention to broader professional growth by immediate supervision.

Electric Boat's location in Groton on the lovely shore of Long Island Sound makes life as pleasant as your job is stimulating. The surrounding resort area is well known for its year-round sports and recreational activities. And, you have all the advantages of nearby New York and Boston as well.

*Interviews can be arranged by sending resumes to Peter Carpenter.*

**ELECTRIC BOAT**

Division of General Dynamics Corporation  
GROTON • CONNECTICUT

**WHAT "CAREER OPPORTUNITY"**

**Means to an Electronic Engineer at General Electric**

"CAREER OPPORTUNITY"...two words you see used everywhere.

**WE USE THEM** a lot at Electronics Park. But with this difference. To every man who comes to work with us, "career opportunity" has a specific meaning.

And for a very good reason.

**ELECTRONICS PARK** is where many new concepts in electronics are born. The G-E organization here is primarily in the business of designing and developing new things—components, systems, equipments. Often a whole new product line results from applied research activities here—and after prelimi-

nary production and sales in this area, a new department is organized to handle it—a new plant built in another area—and a new management staff appointed to direct it.

**AND MANY** of the supervisory and specialist positions in such a new G-E department are drawn from the experienced development staff at Electronics Park.

**JOIN US NOW** . . . if you have a BS, MS or PhD degree in Electrical or Mechanical Engineering or Physics AND/OR electronic experience. Send the coupon below . . . or if you prefer, write us personally in complete confidence.

**TO: GENERAL ELECTRIC**  
Electronics Pk.,  
Syracuse, N. Y.  
ATT: Dept. 10-6-E  
Technical Personnel

I am interested in . . .  
... Advanced Development  
... Design  
... Field Service  
... Technical Writing  
... Sales

In the field of . . .  
... Military Radio & Radar  
... Multiplex Microwave  
... Mobile  
... Communications  
... Semiconductors  
... Electronic Components  
... Computers  
... Tubes & Antennas  
... Television Receivers  
... Industrial Television

**FROM:**

**NAME** \_\_\_\_\_

**ADDRESS** \_\_\_\_\_

**DEGREE** \_\_\_\_\_



nobody  
gets  
"lost in the  
shuffle"  
at



GENERAL PRECISION LABORATORY is organized in small engineering groups where everyone has a chance to use initiative, assume responsibility, show what he can do.

Results tell the story. Just one example: GPL engineers harnessed Doppler and developed the AN/APN-66 air navigation systems that are the most accurate airborne systems in operation today.

At GPL you'll have freedom from administrative routine, and enjoy the satisfaction that comes with using facilities as up-to-date as they come. Because GPL is a member of the nationwide General Precision Equipment Group, you'll share in numerous added employment and professional benefits. And remember—you and your future will never be lost in the shuffle.

If you have the skill and imagination we need—and if you want personal recognition and opportunities to grow in your profession—send your resumé to Richard E. Hoffman, Employment Manager. Interviews can be arranged in advance at any time, including weekends. Security limits us to U. S. citizens only. We will pay the expenses of qualified applicants to come for an interview.

**RADAR NAVIGATION AND BOMBING SYSTEMS (Doppler & Inertial)**

- Research • Development • Applications
- Systems Analysis • Systems Test
- Administrative Engineering • Mechanical Packaging
- Field Engineering • Technical Writing
- Production Follow-up
- Computers • Servos • Microwave Techniques
- Pulse Circuitry • Transistorization

**General Precision Laboratory Incorporated**  
63 Bedford Road, Pleasantville, New York  
In the heart of Westchester County



A SUBSIDIARY OF



electronic & mechanical  
**engineers**

**NEW Opportunities in Fort Wayne  
as Magnavox Continues to Grow**

Integrity, leadership, bold concepts... these have made Magnavox the significant name it is in the world of commercial television and military electronics. And the rewards at this company are many, based on our constant growth and expansion in the field of electronics.

An important way of life goes with Magnavox in Fort Wayne... because this community and its facilities and resources have earned for it the title of "The Happiest City in the United States" according to Look Magazine.

Career positions now open in:

- TELEVISION DESIGN • TEST PROCESS**
- TEST EQUIPMENT • ASW AND COMMUNICATIONS**
- MILITARY PUBLICATIONS • AIRBORNE RADAR**

Please forward complete resume to  
Mr. John Menzies

**THE MAGNAVOX CO.**  
FORT WAYNE 4, INDIANA

**transistor  
circuit  
engineers**

Forward  
confidential  
resume.

No reference  
contact without  
your permission.

Manager of Technical Personnel  
Dept. 674

**ARMA**

Division  
American Bosch  
Arma Corp.  
Roosevelt Field,  
Garden City,  
L.I., N.Y.

Challenging openings in the field of transistor circuit design and development... for application in fire control, navigation and guidance systems... utilizing analog and digital computing techniques.

**ELECTRONIC DESIGNER**

Development and design of industrial measurement and control equipment for the continual process industries. Unusual opportunities in a rapidly expanding firm and industry for personal growth through technical "know how" and hard work. BSEE or MSEE required. 1 to 10 years experience. Servo and feedback experience helpful. Send resume to: 1205 Chesapeake Ave., Columbus 12, Ohio.



**CHIEF ENGINEER  
CONTROLS DIVISION**

\$12,000-\$15,000 Old line, 3 plant corp., 1500 employees, starting new division. Build your own staff and products. Opportunity unlimited. Co. pays fee and relocation.  
28 E. Jackson Blvd. Chicago 4, Ill.  
MONARCH PERSONNEL

**NEED ENGINEERS**

Place an "Engineers Wanted" advertisement in this EMPLOYMENT OPPORTUNITIES section. It's an inexpensive, time saving method of selecting competent personnel for every engineering job in the electronic industry. The selective circulation of ELECTRONICS offers you an opportunity to choose the best qualified men available throughout the industry.



**Top Opportunity For ADMINISTRATIVE ENGINEER**

with  
Light Military  
Electronic Equipment Dept.  
of  
**GENERAL ELECTRIC**  
in Utica, N. Y.  
to \$9,000

The man who qualifies must be familiar with engineering budgets, administrative engineering systems, engineering communications, facilities planning and personnel records and contacts.

Reply in strict confidence to:  
Mr. John Sternberg, Dept. 842

Light Military  
Electronic Equipment Dept.

**GENERAL ELECTRIC**

French Road, Utica, N. Y.

Due to the expansion of our Research Design and Development Division  
**THE WALL STREET JOURNAL is currently seeking:**

**Electro-Mechanical ENGINEERS**

Junior  
**DRAFTSMEN**  
•  
**DRAFTSMEN**  
•

Resume should include complete work history, age, marital status, education, salary desired.

**THE WALL STREET JOURNAL**  
44 Broad St., N. Y. 4, N. Y.

We offer stimulating positions for men interested in Automation of high speed printing equipment and projects on Electro-Mechanical Devices from inception to completion.

- Excellent Advancement Opportunities
- Challenging Projects
- Good Starting Salary
- New York City Location

Profit sharing-retirement plan, group insurance, Blue Cross-Blue Shield, liberal vacation plan.

CLASSIFIED **SEARCHLIGHT SECTION** ADVERTISING

**BUSINESS OPPORTUNITIES**

**EQUIPMENT - USED or RESALE**

**UNDISPLAYED RATE**

\$2.10 a line, minimum 3 lines. To figure advance payment count 5 average words as a line.

PROPOSALS \$2.10 a line an insertion.

BOX NUMBERS count as one line additional in undisplayed ads.

DISCOUNT of 10% if full payment is made in advance for four consecutive insertions of undisplayed ads (not including proposals).

Send NEW Ads or Inquiries to Classified Adv., Div. of Electronics, P. O. Box 12, N. Y. 36, N. Y. for November issue closing October 2nd

The publisher cannot accept advertising in the Searchlight Section, which lists the names of the manufacturers of resistors, capacitors, rheostats, and potentiometers or other names designed to describe such products.

**DISPLAYED RATE**

The advertising rate is \$18.50 per inch for all advertising appearing on other than a contract basis. Contract rates quoted on request.

AN ADVERTISING INCH is measured 7/8 inch vertically on one column, 3 columns—30 inches—to a page.

EQUIPMENT WANTED or FOR SALE ADVERTISEMENTS acceptable only in Displayed Style.

**DUMMY LOAD-X BAND.** 50kw at a duty cycle of 1000 50 watts average. UG10 flange, 9" long, 10 fins. Mfg. for Giffilan. New \$27.50  
**TRANSITION** 1 1/4"x5/8" to 1 3/4"x3/4" (RG51 to RG52) Smooth electroformed taper. Standard flanges. New \$16.50

**WAVEGUIDE TO TYPE "N"** coax adapter. RG52 waveguide 1 3/4"x3/4" New \$14.50  
**DIRECTIONAL COUPLERS.** Three types a) uni-directional b) bi-directional c) cross guide. All 20db apx. All RG52 guide with standard flanges. New \$15.00

**COMPLETE RADAR PLUMBING FRONT END.** o/o 2K25 local osc. mount. 2K25 beacon mount, type N adapter, crystal mount with tuning slug, variable attenuator, beacon xtal mt. beacon N adapter. Also matching duplexer assy. All from latest type Navy Radar by Raytheon. Ideal for radar front end or as a complete laboratory bench set-up. Price incl. duplexer \$32.50. Less duplexer \$42.50. Brand new electrical and mech. tested.

**DALMO-VICTOR HI-SPEED SCANNER** rotating joint assembly 1200 rpm p/o AN/APS-6 complete joint kit. New \$47.50

**MINIATURE 60MC IF STRIP** uses 6 ea. 6AK5 tubes, with synchronous single tuned interstage coupling networks realizing an overall gain of 100db for a band width of 2mc. Weight 9 ounces. \$12.50  
**"BNC" COAXIAL SWITCH** single pole double throw. New \$6.50

**X BAND THERMISTOR** for TS-36 Power Meter \$7.50

**TS33 SIGNAL GENERATOR** complete "X" band coverage. CW output 0 to -70dbm, peak pulse output plus 3 to -67dbm. 0 to 35db attenuator. 2K25 oscillator. Tuneable wavemeter. Temp. compensated power meas. circuit -10 to plus 33dbm. 115 vac 60 cy input. Price like new guaranteed \$275.

**GUIDED MISSILE BEACON**

**FILTER CAVITY F-28/APN-19**

2700-2900 mc, 1.5 db max. loss at ctr. freq. over band, 3db at 15 mc band ends. JAN spec. Ideal as standard reference cavity. Brand new. \$37.50  
**CRYSTAL DETECTOR** assembly p/o AN/APN-19 and 60. 10cm. Low level converter with matching transformer from R10 line to crystal. New \$19.50

**COAX MIXER ASSEMBLY IN21** type crystal detector R10 to R10. "N" fittings, matching slug, duplex couplings. mfg. G.E. New \$18.50

**ADAPTER RG48 WAVEGUIDE** 3"x1 1/4" to type "N" coax. New \$34.50

**THERMISTOR MOUNT 10CM.** Avg power range -5 to plus 11 dbm, 72 ohm type "N" coax input. Accuracy .5db at 5 to 10 mw. Temp range plus 32 to 115F. 2400 to 3400 mc. New \$18.50

**UG65/66U FLANGES** for RG48 guide, high lub, bronze \$10.00

**COMPLETE SURFACE SEARCH RADAR** U. S. Navy type "SO" Raytheon 275kw nominal pulsed output in 3000mc. "N" band. Rotating yoke plan position indicator with 2, 4, 20, 80 mile range selection. Input 115vac, 32vac or 28vac. Lightweight. Delivered complete with installation accessories, set of drawings, instruction books, export cased. Price is less than half the cost of lowest priced commercial radar on market today Write- phone.

**RADIO-RESEARCH INSTRUMENT Co.**

550 - 5 Ave., N. Y. 19, N. Y. Tel: JU 6-4691

PAUL J. PLSHNER

TS46/AP FREQUENCY METER complete 3000mc band coverage with accuracy of .5mc relative, absolute plus and minus 3mc. 200 microamp. meter. Micrometer adjust. Equal to TS-117. New \$35.00

**WESTINGHOUSE Xfmr's—Min. Pulse**

134BW2F RADIATION LAB. # blocking osc. pulse voltage KV 2.5/2.5; 2.5/1.25 pulse duration 1 to 2.5 microseconds. Duty ratio .002. Load imp. 1500. Test voltage 1500 rms. List price \$22.00. Our price new \$9.75 or removed from equipment \$5.75. Fosterized.

148DW2F RADIATION LAB. # pulse output. Pulse voltage KV 2/57(2). Pulse duration .2 to 1 microsec. Duty ratio .002. Load imp. 800. Test voltage 1500 rms. List price \$22.00. Our price removed from equipment \$5.75. Fosterized.

**CW TUNEABLE PACKAGED MAGNETRON.** Tuneable 2800 to 3025 mc with calibration curve. Octal type base. New in original carton \$25.00

**AN/TCC-7 CARRIER TELEPHONE** component units in stock. Write.

**AIRBORNE POWER SUPPLY DY30/APN-19** Complete shock mounted package input 19.5 volts DC 2.7 amps. Output 360 volts at 60 ma. and 100 volts at 10 ma. Will operate 2C40 and 2C43. Part of guided missile radar beacon AN/APN-60. Fully regulated. \$34.50

**SPERRY MICROLINE MODEL 444** klystron signal source. In new condition. Complete source for all Sperry klystrons. List price \$1400. Our price \$425.00

**RCA MICROWAVE LINK**

4000mc band "C" includes modulator and demodulator. Model CW1A late type in very excellent condition. Xmitr uses 2K56 klystron. 2 complete systems incl. 5 ft parabolas. Cost over \$20,000. In stock at \$5000 for all.

- 17—B.C. 348R like new.
- 7—B.C. 312 excellent.
- 70—SCR. 536 like new.
- 19—A.N.F.R.C. 1 Transmitters new.
- 1—T.S. 174U, new.
- 1—B.C. 221 A.K. new.

All units are in new or like new condition—fully guaranteed.

EXPERT IN EXPORT

**A. van Breems—Radio engineer**

907 Shippan Avenue, Stamford, Conn.  
Telephone Fireside 8-4489

**this Searchlight Section of ELECTRONICS**

is an index of reliable sources for Used and Surplus Equipment now available. Consult the Searchlight Section in every issue for later offerings.

If you don't see what you want—ask for it. Ask the advertisers. They are constantly adding to their stocks and may have acquired just what you need. And, when you have special items to dispose of, use the Searchlight Section of Electronics to help you locate buyers. . . . Send a list of your equipment and we will gladly give full information as to space and rates.

Classified Advertising Division

**ELECTRONICS**

P. O. Box 12

New York 36, N. Y.





# NEW YORK'S RADIO TUBE EXCHANGE

## NEW TUBES

Standard brands. First grade only. No pull outs. No rejects. No rebrands. At lowest prices.

Type	Price	Type	Price	Type	Price	Type	Price	Type	Price	Type	Price	Type	Price	Type	Price	Type	Price										
OA2	.85	2J32	12.50	3DP1	3.30	6A	11.00	1K354C	15.00	725A	15.00	902P1	2.75	OA3	.90	2J33	32.00	8DP1A	3.95	C6J	12.50	357A	15.00	726A	6.00	931A	2.50
OB2	.75	2J34	14.25	3EP1	8.50	7B1P7	5.00	368AN	2.00	726H	20.00	951A	.35	OB3	.85	2J36	25.00	3EP9	8.50	7D1P7	9.00	371B	9.00	726G	20.00	955	.35
OC3	.75	2J38	8.95	3GP1	5.00	12AP4	50.00	385A	4.50	730A	7.50	956	.35	OD3	.75	2J39	8.50	3J21	75.00	12DP7A	45.00	388A	1.80	750TL	50.00	957	.35
O11L	1.40	2J40	25.00	4B26	5.40	LM15	200.00	393A	4.50	801A	2.25	959	2.25	1B22	1.50	2J42	60.00	4C27	18.00	15E	1.50	391A	2.50	802	2.00	E118	.25
1B23	6.95	2J49	40.00	4C28	23.00	15H	.50	MX108U	50.00	803	5.00	1280	1.20	1B24	12.00	2J50	55.00	4E27	8.50	NE16	59	417A	2.75	805	3.00	902P2	2.75
1B24	15.00	2J55	55.00	4J25	50.00	20F	.75	434A	15.00	807	1.20	1500T	135.00	1B26	1.25	2J56	110.00	4J26	50.00	KY21A	8.25	446A	7.50	808	1.90	HK1554	75.00
1B27	10.00	2J61	20.00	4J27	50.00	RK21	2.50	446B	3.95	809	2.25	1603	3.25	1B38	35.00	2J62A	35.00	4J28	50.00	RX21	8.00	450TH	47.50	810	10.50	1612	1.50
1B50	23.00	2J62	15.00	4J29	50.00	K1124G	1.50	450TL	47.50	811A	3.75	1613	1.25	1B51	7.50	2K22	14.50	4J30	30.00	25T	2.95	461A	2.65	812A	3.95	1616	.50
1B56	35.00	2K23	17.00	4J31	150.00	RK72	.60	471A	4.00	812A	3.95	1619	.30	1B60	35.00	2K25	12.00	4J32	150.00	RK73	.50	527	18.00	813	10.95	1622	1.25
1B21	.50	2K26	44.00	4J33	150.00	RK95	21.00	WL530	4.00	814	2.50	1624	1.25	1N21A	.95	2K28	25.00	4J34	100.00	100T11	6.50	WL531	4.00	815	1.50	1625	.30
1N21B	1.25	2K29	28.00	4J35	150.00	FG105	11.00	WL533	15.00	816	6.00	1626	.25	1N21C	12.50	2K33A	125.00	4J36	150.00	122A	1.75	HK654	35.00	829	1.00	1851	1.80
1N22	.50	2K39	140.00	4J37	75.00	203A	2.50	700A/D	10.00	829A	7.00	2000T	150.00	1N23	.50	2K41	95.00	4J38	150.00	211	.50	701A	2.75	829B	8.00	2050	1.00
1N23A	.50	2K42	180.00	4J39	150.00	217C	2.90	703A	1.10	830B	.70	2051	.65	1N23B	1.50	2K43	110.00	4J40	150.00	242C	10.90	704A	.75	832A	6.00	5820	475.00
1N23C	7.50	2K44	195.00	4J41	150.00	244C	9.50	705A	.75	833A	36.00	5826	450.00	1N25	4.50	2K45	35.00	4J42	180.00	249C	2.50	706A	.334	7	7.50	8012	1.00
1N26	4.00	2K48	75.00	4J51	190.00	250T11	23.00	FY	25.00	836	1.50	8012A	2.50	1N27	3.50	2K50	295.00	4J52	225.00	250T11	14.00	707A	3.50	837	1.25	8013	3.00
1N34A	2.25	2K51	35.00	4J53A	225.00	252A	3.95	271B	2.00	711AY	35.00	819	35.00	1N34B	1.95	2K55	15.00	51P1	3.95	271B	2.00	711AY	35.00	819	35.00	8019	1.75
1P25	65.00	2K56	72.00	51P2A	12.00	30T11H	8.75	715A	1.75	857B	125.00	8020	2.00	2C39	7.50	3AP1A	10.00	51P4	3.95	304TL	10.50	715B	3.00	860	3.00	8025	2.00
2C39A	9.00	3BP1	7.20	5CP1	1.75	307A	.60	715C	12.00	861	25.00	P38365	96.00	2C40	9.50	3B21	1.50	5CP2	5.00	310A	4.50	717A	.35	866A	1.25	9001	.85
2C43	8.50	3B25	5.00	5CP2A	18.00	310B	4.95	719A	11.00	869B	67.00	9002	.65	2C14	2.25	3B26	5.00	5CP12	5.00	311A	5.50	720AY	50.00	9003	1.35		
2C16	6.00	3B28	5.00	5D21	7.95	312A	2.95	GY	50.00	872A	1.25	9004	.85	2A	12.00	EL3C	5.50	5Jp1	27.50	323A	15.00	721A	.75	874	.60	9005	2.75
2J22	4.50	3C22	59.00	5Jp2	6.00	327A	3.50	721B	7.25	878	.50	9006	.20	2J26	15.00	3C22	59.00	5Jp2	6.00	327A	3.50	721B	7.25	878	.50	9006	.20
2J27	4.50	3C24	1.75	5J25	11.00	325A	6.75	723A/B	7.85	879	.75	884	1.00	2J31	14.25	3C31	1.40	5LPI1A	25.00	350B	2.75	724B	.75	885	1.00		

**Special! TS45 X BAND GENERATOR — \$99.00**

**NEW UNUSED SURPLUS TS 259 K BAND**  
23400-24500 MEGACYCLES SIGNAL GENERATOR

**SPECIAL! 5,000 V. POWER SUPPLY**  
For IP25 Infrared Image Converter from 3 V. Battery Source. **\$9.90**  
NEW, Complete with RCA 1C54 Tube.

**NEW MICROWAVE TEST EQUIPMENT**  
TS148/UP SPECTRUM ANALYZER  
TS147D SIGNAL GENERATOR

Field Type X Band Spectrum Analyzer. Band 8430-9580 Megacycles. Will Check Frequency and Operation of various X Band equipment such as Radar Magnetrons, Klystrons, TR Boxes. It will also measure pulse width, c-w spectrum width and Q or resonant cavities. Will also check frequency of signal generators in the X band. Can also be used as frequency modulated Signal Generator etc. Available new complete with all accessories, in carrying case.

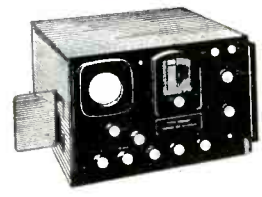

**OTHER TEST EQUIPMENT USED CHECKED OUT SURPLUS**

TSK1/SE	T35/AP	TS108	TS226	SURPLUS EQUIP.
TS3A/AP	TS36/AP	TS110/AP	TS239A-TS239C	
RF4/AP	1-96A	TS125/AP	APA10	
TS12/AP	TS45	TS126/AP	APA38	
TS13/AP	TS47/APR	TS147	APS3 APS4	
TS14/AP	TS69/AP	TS174/AP	APR4	
TS33/AP	TS100	TS175/AP	APR5A	
TS34/AP	TS102A/AP	TS182	APT2-APTS	

**SPECIAL**

Available Large quantities at special prices

2AP1	6H6	307A	5691
4C27	6K8G	274A	5692
4C28	6AR6	274B	5693
5A6	5RWGY	582B	5699
5BP4	5W4GT	328A	5814
4J52	0F4A	357A	9001
2A4G	6AC7	450TH	9002
6C21	28D7	450TL	9003
6J5GT	VT52	957	9006
	89		

WHOLESALE and EXPORT ONLY



Phone: ORegon 4-7070

**LIBERTY ELECTRONICS, INC.**

119 PRINCE ST.  
NEW YORK 12, N. Y.  
Cable: TELESERUP

**SAVE dough! / HARJO!**

**RCA TV CAMERA**



**NEW Surplus for Labs! Export! Industrial! Medicine! Closed Circuit TV!**  
Ideal for labs, industry, prisons, TV technicians, swim pools, medics—"mechanical eye" for closed circuit TV. 1816 Iconoscope, 6-stage video amplifier and clipper. THE REAL THING! Send for new, free, complete technical data. SOLD AT FRACTION OF REAL VALUE!

TEST EQUIPMENT	GROUND ELECTRONICS	AIRCRAFT ELECTRONICS	POWER ELECTRONICS
TS-10C	ARB	ARC-1	DY-11
TS-125	ART-13	ARC-3	DY-12
TS-13	BC-191	ARC-4	DY-17
TS-15	BC-182	ARC-5	Pioneer 12117
TS-16	BC-222	LP-21	Pioneer 12123
TS-19	BC-348	ARC-12	Pioneer 12133
TS-24	BC-312	IE-19	Pioneer 12142
TS-25	TCS-12		
TS-268			
TS-32			
TS-33			
TSX-45E			
TS-34			
TS-35			
TS-36			
TS-45			
TS-47			
TS-59			
TS-89			
TS-110			

**RADAR EQUIP.**

- APS-4,-6
- SCR-717,-720
- APQ-13

**Harjo Sales Co.**

Office-Warehouse: 503 N. VICTORY BLVD. BURBANK, CALIF. Phone: Thornwall 5-2613

**NEED METERS?**  
STANDARD or SPECIALS

ANY QUANTITY — NEW — MILITARY  
**FOR** ELECTRONIC — MILITARY  
AIRCRAFT — HAMS

**ALL** MAKES — MODELS  
RANGES — SIZES  
**METERS** REPAIRED  
RESCALED  
RECALIBRATED

WRITE - PHONE - WIRE  
**INSTRUMENT SERVICE**  
76-14 Woodside Ave.  
Elmhurst 73, N. Y.  
CAA No. 4264 Ltd. HA 9-2925

**A B RESISTORS** •••• Legri S Company  
391 Riverside Ave.  
Yonkers 5, N. Y.

Phone: Yonkers 9-6000

# ELECTRONIC

WAR TERMINATION INVENTORIES

WRITE OR WIRE FOR INFORMATION ON OUR COMPLETE LINE OF SURPLUS ELECTRONIC COMPONENTS. ALL PRICES NET F.O.B. PASADENA, CALIFORNIA

# C&H SALES CO.

2176-E East Colorado St.  
Pasadena 8, California  
RYan 1-7393

## INVERTERS

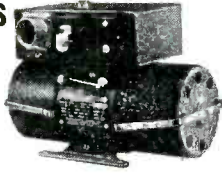

- 10042-1-A Bendix  
DC Input 14 volts; output: 115 volts; 400 cycles. 1-phase; 50 watt **\$35.00**
- 12116-2-A Bendix  
Output: 115 VAC; 400 cyc; single phase; 45 amp. Input: 24 VDC, 5 amps. **\$35.00**
- 12117 Bendix  
Output: 26 volts; 400 cycles, 6 volt amperes. 1 phase. Input: 24 VDC; 1 amp. **\$15.00**
- 12121 Bendix  
Input: 24 volt D.C. 18 amp. 12000 r.p.m. Output: 115 volts, 400 cycle, 3-phase, 250 volt amp, 7 pf. **\$49.50**
- 12123 Bendix  
Output: 115 V; 3-phase; 400 cycle; amps .5 Input: 24 VDC; 12 amp. **\$49.50**
- 12126-2-A Bendix  
Output: 26 volts; 3 phase; 400 cycle; 10 VA; 6 PF. Input: 27.5 volts DC; 1.25 amps. **\$24.50**
- 12130-3-B Bendix  
Output: 125.5 VAC; 1.5 amps. 400 cycles single phase, 141 Va. Input: 20-30 VDC. 18-12 amps. Voltage and frequency regulated. **\$49.50**
- 12133 Bendix  
Input: 26/29 volt D.C., 28 amps. Output: 115 volt, 3 phase, 400 cycle, 250 vo-t amp., .8 pf. **\$59.00**
- 12147-1 Pioneer  
Output: 115 VAC 400 cycles; single phase. Input: 24-30 VDC; 8 amps. **Price \$39.50 each**
- 778 Bendix  
Output: 115 volt 400 cycle; 190 VA; single phase and 26 volt, 400 cycle, 60 VA, single phase. Input: 24 VDC. **\$37.50**
- 10285 Leland  
Output: 115 volts AC; 750 VA, 3 phase, 400 cycle, .90 pf and 26 volts. 50 VA single phase, 400 cycle, .40 pf. Input: 27.5 VDC 60 amps. cont. duty, 6000 rpm. Voltage and frequency regulated. **\$59.50**
- 10339 Leland  
Output: 115 volts; 190 VA; single phase; 400 cycle, .90 pf. and 26 volts; 60 VA; 400 cycle, .40 pf. Input: 27.5 volts DC, 13 amps. cont. duty, voltage and freq. regulated. **\$49.50**
- 10486 Leland  
Output: 115 VAC; 400 cycles; 3-phase; 175 VA; .80 pf. Input: 27.5 DC; 12.5 amps.; cont. duty. **\$70.00**
- 10563 Leland  
Output: 115 VAC; 400 cycle; 3-phase; 115 VA; 75 pf. Input: 28.5 VAC; 12 amps. **\$35.00**
- PE109 Leland  
Output: 115 VAC, 400 cyc.; single phase; 1.53 amp.; 8000 rpm. Input: 13.5 VDC; 29 amp. **\$50.00**
- PE218 Leland  
Output: 115 VAC; single phase pf. 90; 380/500 cycle; 1500 VA. Input: 25-28 VDC; 92 amps.; 8000 rpms.; Exc. Volt: 27.5. **BRAND NEW \$30.00**
- MG149F Holtzer-Cabot  
Output: 26 VAC @ 250 VA; 115 V. @ 500 VA; single phase; 400 cycle. Input: 24 VDC @ 36 amps. **\$40.00**
- MG153 Holtzer-Cabot  
Input: 24 VDC; 52 amps. Output: 115 volts —400 cycles, 3-phase, 750 VA. Voltage and frequency regulated. **\$95.00**
- DMF2506M Continental Electric  
24-30 volts input; 5.5-45 amps.; cont. duty. Output: 115 volts; .44 amps.; 400 cyc.; 1 phase; pf. 1.0; 50 watts. **\$39.50**
- 940702-1 Eicor, Class "A"  
Input: 27.5 volts at 9.2 amps. AC. Output: 115 volts 400 cycles; 3 phase 100 voltamp; continuous duty. **Price \$39.50 each**

## KEARFOTT GYROS



- Rate T-2004-3C-A ..... **\$150.00**
- Rate T-2005-1B-A ..... **\$150.00**
- Vertical T-2103-1A ..... **\$200.00**
- Free T-2305-1A-A ..... **\$200.00**

## SELSYNS-SYNCHROS



- 1CT Cont. Trans. 90/55V 60 cy. **\$37.50**
- 1DG Diff. Gen. 90/90V 60 cy. **37.50**
- 1F Syn. Mtr. 115/90V 60 cy. **37.50**
- 1G Gen. 115V 60 cy. **37.50**
- 1SF Syn. Mtr. 115/90V 400 cy. **12.50**
- 2J1F1 Gen. 115/57.5V 400 cy. **7.50**
- 2J1F3 Gen. 115/57.5V 400 cy. **10.00**
- 2J1FA1 Gen. 115/57.5V 400 cy. **7.50**
- 57.5/57.5V 400 cy. **5.00**
- 2J1H1 Diff. Gen. 57.5V 400 cy. **7.50**
- 2J1S01 Cont. Trans. 105/55V 60 cy. **17.50**
- 2J1S1 Cont. Trans. 105/55V 60 cy. **17.50**
- 2J1S1H Gen. 115/105V 60 cy. **17.50**
- 2J1S1M1 Gen. 115/57.5V 400 cy. **34.50**
- 5CT Cont. Trans. 90/55V 60 cy. **34.50**
- 5D Diff. Mtr. 90/90V 60 cy. **34.50**
- 5DG Diff. Gen. 90/90VAC 60 cy. **34.50**
- 5F Syn. Mtr. 115/90VAC 60 cy. **34.50**
- 5G Syn. Gen. 115/90VAC 60 cy. **42.50**
- 5HCT cont. Trans. 90/55V 60 cy. **12.50**
- 5SDG Diff. Gen. 90/90V 400 cy. **25.00**
- 6DG Diff. Gen. 90/90V 60 cy. **34.50**
- 6G Syn. Gen. 115/90VAC 60 cy. **42.50**
- 7G Syn. Gen. 115/90VAC 60 cy. **42.50**
- R110-2A Kearfott Cont. Mtr. 115V 400 cy. **17.50**
- R200-1A Kearfott Cont. Trans. 26/11.8V 400 cy. **15.00**
- R210-1A Kearfott Trans. 26/11.8V 400 cy. **15.00**
- R220-1A Kearfott Receiver 26/11.8V 400 cy. **20.00**
- R235-1A Kearfott Resolver 26/11.8V 400 cy. **22.50**
- C56701 Type 11-4 Rep. 115V 60 cy. **20.00**
- C69403-2 Type 1-1 Transm. 115/ 60 cy. **20.00**
- C69406 Syn. Transm. 115V 60 cy. **20.00**
- C69405-1 Type 11-2 Rep. 115V 60 cy. **20.00**
- C76166 Volt. Rec. 115V 60 cy. **10.00**
- C78243 Syn. Transm. 115V 60 cy. **12.50**
- C78249 Syn. Diff. 115V 60 cy. **5.00**
- C78863 Repeater 115V 60 cy. **7.50**
- C79331 Transm. Type 1-4 115V 60 cy. **20.00**
- 851 Bendix Autosyn Mtr. 22V 60 cy. **7.50**
- 403 Kollsman Autosyn. Mtr. 32V 60 cy. **7.50**
- FPE-25-11 Diehl Servo Mfr. 75/115V 60 cy. **22.50**
- FPE-4C-1 Resolver 400 cy. **25.00**
- FJE-43-9 Resolver 115V 400 cy. **25.00**
- 999-04-11 Kollsman 26V 400 cy. **15.00**
- 13770410 Kollsman 26V 400 cy. **10.00**
- 1515B-0410 Kollsman 26V 400 cy. **20.00**
- 10047-2-A Bendix 26V 400 cy. **12.50**
- 2900 Transcoil 115 V 400 cy. **15.00**

## SIMPLE DIFFERENTIAL



Size: 2-5/32" long x 1 1/4" dia.; bearing one end 1/2" O.D.; Shaft Size: 1" long, threads 8-32-3/4" long, with bearing shaft 1/8" dia. x 1/4" long. Gear on shaft end 1-7/16" dia., gear on bearing end 1 1/4" dia. Drive gear 25/32" dia.

**\$3.95 ea.**

Stock No. 101

## SIMPLE DIFFERENTIAL



1:1 reverse ratio, 60 teeth on large gear; 1/4" shaft. Size: 3" long with 1-15/16" dia.

**\$3.95 ea.**

Stock No. 106

## SIMPLE DIFFERENTIAL



size 2-3/8" long, 1-1/8" diameter, 1/4" shaft each end 1:1 reverse ratio 32 teeth on input and output gear price..... **\$3.50 each**

stock no. 149

## Dual Simple Differential



1:1 reverse ratio on both. Size: 3 1/4" long x 1-7/16" dia. Shaft size: 1/8" and 5/32".

**\$7.50 ea.**

Stock No. 110

## SMALL DC MOTORS

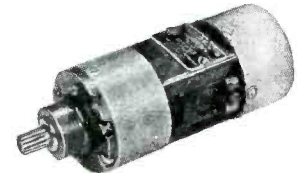

- (approx. size overall 3/4" x 1 1/4" dia.):
- 5069600 Delco PM 27.5 VDC 250 rpm **12.50**
  - 50669230 Delco PM 27.5 VDC 145 rpm **15.00**
  - 5068750 Delco PM 27.5 VDC 160 rpm w/brake **6.50**
  - 5068571 Delco PM 27.5 VDC 10,000 rpm (1x1x2") **5.00**
  - 5069625 Delco 27.5 VDC 120 rpm w/governor **15.00**
  - 5BA10A118 GE 24 VDC 110 rpm **10.00**
  - 5BA10AJ37 GE 27 VDC 250 rpm reversible **10.00**
  - 5BA10AJ52 27 VDC 145 rpm reversible **12.50**
  - 5BA10AJ50, G.E., 12 VDC, 140 R.P.M., reversible **15.00**
  - 5BA10FJ32, G.E., 12 VDC, 9.5 R.P.M., reversible **15.00**
  - 5BA10FJ33, G.E., 12 VDC, 56 R.P.M., reversible **15.00**
  - 806069 Oster series reversible 1/50 h.p. 10,000 rpm 27.5 VDC 1 5/8" x 3 1/2" **5.00**
  - C-28P-1A 27 VD: 1/100 h.p. 7,000 rpm **3.00**
  - 7100-B-PM Hansen 24 VDC 160 rpm **7.50**
  - SSFD-6-1 Diehl FM 27.5 VDC 10,000 rpm **4.00**



COMMUNICATIONS EQUIPMENT CO.

PULSE TRANSFORMERS

352-7150. Primary 50 ohms. Secondary 1000 ohms. 1200v, 1.0 Amp. Pulse: 1 or 2 usec, at .001 duty ratio. Fitted with magnetron well and bifilar winding for filament supply. \$32.50
MAGNETRON PULSE TRANS. #964: Prim. imp. 30 ohms. 1600 v. pulse. Secondary imp. is 1250 ohms, 12 KV pulse. Turns ratio: pri. is 7.5:1. Duty ratio is 0.001 at 1.2 usec. Bifilar winding 1.2A. \$8.50
RAYTHEON WX 4298E: Primary 4KV., 1.0 USEC. SEC. 16KV-16 AMP DUTY RATIO: 001 400 CYCLE PUL TRANS. "BUILT-IN" \$22.50
WECO: D-163247 For Modulator of SCR 720. \$22.50
GE #K-2449A (As Shown)
Primary: 9.33 KV., 50 ohms Imp.
Secondary: 28 KV., 450 ohms.
Pulse length: 1.05/5 usec @ G35/120
PPS. PK Power Out: 1.740 KW.
Bifilar: 1.5 amps. \$62.50
GE #K-2748-A, 0.5 usec @ 2000 PPS.
PK. Pwr. out is 32 KW. Impedance
40-100 ohm output, Pri. is 2.8 KV Pk. Sec. volts
11.5 KV Pk. Bifilar ratio at 1.3 Amp. Fitted with
magnetron well \$24.50
K-2745 Primary: 3.1/2.8 KV., 50 ohms Z. Secondary:
14/12.6 KV 1025 ohms Z. Pulse length: 0.25/1.0 usec
@ 600/600 PPS. Pk. Power 200/150 KW. Bifilar: 1.3
Amp. Has "built-in" magnetron well. \$32.50
K-2461-A, Primary: 3.1/2.8 KV., 50 ohms (line). Sec-
ondary 14/12.6 KV 1000 ohms Z. Pulse length: 1
usec @ 600 PPS. Pk. Power Out: 200/130 KW. Bifilar
1.3 Amp. Fitted with magnetron well. \$29.50
K35145 Pulse Inversion: PRI: 5 KV PK. Pulse Negative. Sec. Pos. Pulse, 4 KV; 1 usec and .001 DUTY
RATIO \$25.50
541318-I-3 wdgds. Ratio: 1:1.1. 1.0 mh. /wdg. 2.5
ohms. DCR \$33.50
UTAH X-151T-1: Dual Transformer, 2 Wdgs. per section
1:1 Ratio per sec 13 MH inductance 30 ohms
DCR \$5.00
UTAH X-150T-1: Two sections, 3 Wdgs. per section,
1:1.1 Ratio, 3 MH, 6 ohms DCR per Wdg. \$5.00
68G71: Ratio: 4:1 Pri. 200V, Sec. 53V. 1.0 usec Pulse
@ 2000 PPS. 0.016 KVA \$4.50
TR1049 Ratio 2:1 Pri. 220 MH, 50 Ohms, sec. 0.75 H.
DCR 100 Ohms \$6.75



SPECIAL VALUES

Receiver front end cavity resonator: Tunes 2700 to 3400 mc with a loaded Q of 3000. 50-ohm, type N input. Video output from LN27 crystal. May be used at quarter wave (1.1 to 1.4 km). \$22.50
10 CM. ANTENNA ASSY. (Airborne), 30" dish with coax. dipole feed. Focal length is 10" Horiz. polarization, 350 deg. azimuth. Fil: plus and minus 20 deg. 25 vdc drive motor, seslyn takeoff. \$65.00
CRYSTAL OVEN, B illey #TCO 2B. Local ba. with provision for 2 crystals, 6.3V heater 75 deg. Cent. \$2.50
COAX. SWITCH, 4 pos. 52 ohms imp. Fitted with type N connectors. Useful up to 3,000 mc. \$17.50
APT-4 Jamming transmitter. Uses 5J30 or 5J31 magnetron. Power output: 130 watts, 350-760 mc. New complete with tubes. \$115.00
M-30/APT-4. Modulator. For noise modulating of APT-4. Operates from 115v. 400 cy. New. \$45.00
L & N RATIO BOX, #1553. Basic unit for capacitance, impedance, and conductance bridge. New, complete with instruction book. \$225.00
FILTER, Artificial Line: WECO D163169, 650 ohms input, insertion loss: 5 db. \$32.50
Barry shock mounts: nos. 2046, C-2060, C-2070, C-2090. \$45 ea.
Trihedral radar reflector, MK-1, aluminum. \$3.50
SPLICER, for 11/16 perforator tape, WECO #X-61859 list 20 SCS =4TW 61859-20. Complete set, with number plate dispenser. \$8.50
MN 28Y Control box, unit of MN 28 compass. New. \$3-75
Noise filters, Mallory NF-1, 100 amp/35vdc. \$1.00
Power supply unit, navy type #L-2. Input: 115 vdc. 60 cy. Output: 135 vdc/10 ma. 90 vdc/5ma; 3 vdc/360 ma. New, complete with spare parts box. To be used with model TBX radio gear. \$9.50
Pulse analyzer, type APA-6. With 3 in. scope. \$235
BC 602 Control box for SCR 522 (pushbutton). \$3.75
24-Volt Transformer. Input 115v/60 cy. Output 24 v/3A box \$34.50
TEL. REPEATER, EE 89, complete with tubes and tech. manual. \$17.50
TEL. REPEATER, EE 99, with 12 vdc. vibrator power supply (RPN 204). \$49.50
F.T.&R. 101-A. Two-wire applique, contains equalizing devices, and balancing circuit. Used for adapting 4-wire military circuits to 4-wire systems. \$1.75
Button Bank unit. Tunes 60-300 mc. Ideal for frequency meter, grid-dipper, signal source, etc. New, complete with acorn tube socket. \$5.75

10 CM R.F. HEAD

Complete R.F. Head and Modulator delivers 50 KW Peak R.F. at 3000 MC. Pulse delivers 12KV pulse at 12 Amp. to magnetron of 5. 1, or 2 microsec. duration at duty cycle of .001. Unit requires 115V. 400-2400 Cycles, 1 phase @ 8.5A. Also 24-28 VDC @ 2A. External sync. Pulse of 120V Req'd Brand New. Complete with magnetron, magnet, plumbing and all tubes. \$375.00

MICROWAVE EQUIPMENT

X BAND - 1" x 1/2" WAVEGUIDE

AT-68-UP 3 Cm Horn with type N feed for receiver measurements, etc. New \$7.45
ROTARY JOINT (APS-6) Sperry PT #658275, 180 deg. rotation, choke-to-choke. Has "Built-in" Di-Coupler, 20 DB, with "N" Takeoff. \$22.50
PARABOLOID DISH, 18" diam. Spun Aluminum, 8" Focus. For AN/AP5-6. \$4.95
3 CM. DIPOLE and Feed Assembly. (May be used with above dish.) 8 inches long. \$5.00
FLEXIBLE SECTION 9 in. long. Cover-to-Cover. \$5.50
ROTARY JOINT (APS-6) Sperry PT #65875, 180 deg. rotation, choke to choke. Has "Built-in" Di-Coupler, 20 DB, with "N" Takeoff. \$22.50
3 CM. DIPOLE FEED, 15" L. for APS. 15. \$14.50
MITRED ELBOW, Cast aluminum, 1 1/4" x 3/8" V.G. W.E. Flanges "E" Plane. \$3.50
RG52/U Waveguide in 5' lengths, fitted with UG 39 flanges to UG40. Silver plated. per length \$5.00
Rotating-Joints supplied either with or without deck mountings. With UG40 flanges. each \$17.50
Bulkhead Feed-thru Assembly. Pressure Gauge Section with 1/8 lb gauge. \$10.00
Directional Coupler, UG-40/U Take off 20db. \$17.50
MAGNET AND STABILIZER CAVITY For 2141 Magnetron. \$24.50
90 degree elbows, "E" Plane 2 1/2" radius. \$8.50
CROSS GUIDE directional coupler UG40 output flange. Main guide is 8" long with 90" "E" plane bend at one end, and is fitted with std. UG39/U40 flanges. Coupling figure 20DB. \$22.50

10 CM.—RG48/U Waveguide

10CM ECHO BOX: Tunable from 3200-3333 Mc. For checking out radar transmitters, for spectrum analysis, etc. Complete with pickup antenna and coupling devices. \$17.50
POWER SPLITTER for use with type 726 or any 10 CM Shepherd Klystron. Energy is fed from Klystron antenna through dual pick-up system to 2 type "N" connectors. \$12.50
LHTR LIGHTHOUSE ASSEMBLY. Parts of RP39 APG 5 & APG 15. Receiver and Trans. Cavities w/ assoc. Tr. Cavity and Type N CPLG. To Recv. Uses 2C40, 2C43, 1B27. Tunable APX 2400-2700 MCS. Silver Plated. \$15.00
BEACON LIGHTHOUSE cavity p/o UPN-2 Beacon 10 cm. Model. Broad Band. \$27.50
MAGNETRON TO WAVEGUIDE Coupler with 721-A Duplexer Cavity, gold plated. \$31.50
721A TR BOX complete with tube and tuning plungers. \$12.50
AS14A AP-10 CM Pick up Dipole with flange adapter. \$4.50
HORNLED-TO-TYPE "N" Male Adapters, W.E. #D167284. \$2.75
BEACON ANTENNA, AS31/APN 7 in Lucite Ball. Type "N" feed. \$22.50
ANTENNA, AT39A/APR: Broadband Conical. 300-3300 MC Type "N" Feed. \$12.50
"E" PLANE BENDS, 90 deg. less flanges. \$7.50

PULSE NETWORKS

H-616 10KV, 2.2 usec., 375 PPS, 50 ohms imp. \$27.50
H-615 10KV, 0.85 usec., 750 PPS, 50 ohms imp. \$27.50
H-605: 25 KV. "E" CKT. 1.5 usec. 400 PPS. 50 Ohms Impedance. 5 sections. \$62.50
7-5E3-1-200-67P, 7.5 KV "E" Circuit, 1 microsec. 200 PPS, 67 ohms impedance 3 sections. \$7.50
7-5E4-16-60, 67V, 7.5 KV "E" Circuit, 4 sections 16 microsec. 60 PPS, 67 ohms impedance. \$15.00
7-5E3-3-200-67P, 7.5 KV. "E" Circuit, 3 microsec. 200 PPS. ohms imp. 3 sections. \$12.50
H-616 10KV, 2.2 usec., 375 PPS, 50 ohms imp. \$27.50
H-615 10KV, 0.85 usec., 750 PPS, 50 ohms imp. \$27.50

DYNAMOTORS

Table with columns: TYPE, INPUT VOLTS, INPUT AMPS, OUTPUT VOLTS, OUTPUT AMPS, PRICE

INVERTERS

800-1B Input 24 vdc. 62 A. Output: 115 V. 800 cy. 7A. 1 phase. Used, excellent. \$18.75
PE-218H: Input: 25/38 vdc. 92 amp. Output 115V 300/500 cy. 1500 volt-ampere. NEW. \$32.50
PE-206: Input: 28 vdc. 36 amps. Output: 80V 800 cy. 500 volt-amp. Dim. 13 x 5 1/2 x 10 1/2. New. \$22.50
EICOR-ML 3011-5. Input: 13.75 V; 18.4A. Output: 115 V/400~, 3 ph. 0.95 PF 100 VA. New. \$59
PU 7/AP, Input: 28 vdc/160A. Output: 115 VAC. 400~, 1 ph. 500 VA., 21.6 Amp. Volt. and Freq. Reg. Used, Exc. \$37.50

MICROWAVE ANTENNAS



AT49/APR—Broadband Conical, 300-330 MC. Type N Feed (as shown). \$8.95
3 CM ANTENNA ASSEMBLY: Uses 17" paraboloid dish, operating from 24 vdc motor. Beam pattern: 5 deg. in both Azimuth and elevation. Sector Scan: over 160 deg. at 95 scans per minute. Elevation Scan: over 2 deg. Tilt: Over 24 deg. \$35.00
3 cm. Horn, 1" x 1/2", with twist and 180 deg. bend. With dielectric window. \$22.50
Discone Antenna, AS 125/APR, 1000-3200 mc. Stub supported with type "N" Connector. \$14.50
AS14A/AP, 10 CM pick up dipole assy, complete w/ length of coax and "N" connectors. \$4.50
30" Paraboloid Reflector Spun Aluminum dish 10 1/2" Focus. \$4.85
AN/APA-12—Reflector Scan adaptor for APS-2 radar—Complete Kit. \$37.00
18" PARABOLIC DISHES, spun aluminum. Focus approx. 8 inches. \$4.95

I. F. AMPLIFIER STRIPS



Model 15-30 Mc Center Frequency, Bandwidth with 2.5 Mc. gain figure, 65 db. (Uses 5 standard tubes, 6 SACT's, Has a D. C. Restorer and Video Detector A.F.C. Strip included. Input impedance: 50 Ohms. Less tubes (as shown) \$17.50
60 MC. Miniature IF strip, using 6AK5's 60 Mc center Freq. Gain, 15 db. Bandwidth of 2.7 Mc. New. Complete with tubes. \$15.00

TEST EQUIPMENT

RF-3/AP ECHO BOX, tunes 8200-9500 mc. Cavity has a Q of 30,000 and is tuned by means of an internal 24 vdc motor. Unit is tunable over a range of 80 mc. When motor is left on, the tuning plunger goes thru the tuning range three times per minute. During the tuning motion, an eccentric cam on the mechanism causes an additional flutter action of the tuning disk at approximately 200 cycles per minute. This flutter causes an additional 15 mc. This eliminates need of stopping the motor at the peak of the signal, and also gives a characteristic pattern to the echo signal. New, with pickup antenna. \$95.00
TEST OSCILLATOR TS-47/APR, 40-2000+ Mc. Fundamental coverage 40-500Mc in two ranges. Harmonics above 2000 Mc. Provides a calibrated (dial accuracy ±0.7 per cent) H.F. source for testing receiving equipment. Output 3MW or more up to 400 Mc. less on harmonics. C.W., mod. pulse or sine wave output. Operates on 115/230 60 Cy. or batteries. Part of APR countermeasures equipment. New. \$120
TS 13/AP, Signal source 9305-9445 mc, 50 microwatts. Comes with a wavemeter, thermistor-bridge power meter, and calibrated attenuator. Oscillator is a klystron type 723-a which may be internally (self-synch) or externally pulsed. Controls are provided for FM operation, variable pulse delay, pulse width and phasing. Operates from 115 v., 60-800 cps. New. \$375
TS 235 DUMMY LOAD: Provides excellent impedance match for peak powers of up to 750 kw. at .001 duty ratio. Frequency range 400-4,000 mc. Complete with blower. \$150
TS-56A/AP TEST EQUIPMENT. Slotted line test equipment designed for operation over a frequency of 500-875 MC. Has impedance of 51 ohms. Ideal test set for matching antennas, measurement of characteristics of transmission line. With instructions manual. New. Shipping wt.: 41 lbs. \$95.50

400 CYCLE TRANSFORMERS

Table with columns: Model Number, Specifications, Price

MAIL ORDERS PROMPTLY FILLED. ALL PRICES F.O.B. NEW YORK CITY. M.O. OR CHECK. ONLY SHIPPING SENT C.O.D. RATED CONCERNS SEND P. O. PARCELS IN EXCESS OF 20 POUNDS WILL BE SHIPPED VIA CHEAPEST TRUCK OR RAILX.

343 Canal St., New York 13, N.Y. Dept. E-10 Chas. Rosen Phone: CAAnal 6-4882

# RELAYS

world's largest stock

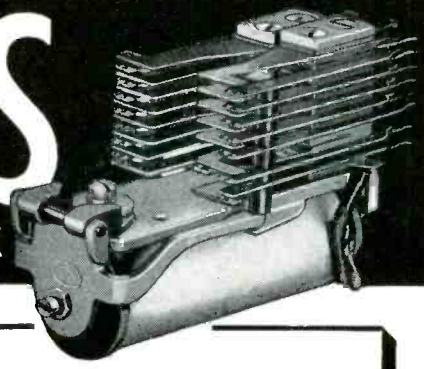

- ★ Immediate Delivery
- ★ Hundreds of Types
- ★ All Standard Makes
- ★ New-Inspected-Guaranteed

See Our Ad On Page 125

Multiple Contact  
**Standard Telephone Type Relay**  
 CODE 4 TWIN CONTACTS  
 11-Form A 1-Form B 1-Form C 1-Form D  
 Heavy duty armature bearing. Available in all standard coil resistances from 12 ohms to 12,000 ohms. Single or quantity prices on request. In stock.

24 HOUR DELIVERY OF THESE TYPES

Standard Telephone Relays  
 Short Telephone Relays  
 Midget Relays  
 Timers  
 Aircraft Contactors  
 Rotary Relays  
 Western Electric  
 Type "E" Relays

Keyed Relays  
 Hermetically Sealed Relays  
 Voltage Regulators  
 and Cutouts  
 Differential and  
 Polarized Relays  
 Special Relays  
 BK Series

Antenna and Ceramic Relays  
 Motor and Control Relays  
 Relay Assemblies  
 Latching and Interlocking  
 Relays  
 Mechanical Action Relays  
 Ratchet and Stepping Relays  
 Time Delay Relays

Write for New Relay Sales  
 Catalog, C-7



P. O. Box 186-AA, West Chicago, Ill. Phone West Chicago 1100

# OPERATING

ON EVERY CONTINENT  
 IN THE ENTIRE WORLD  
 WE SOLD THEM!

## COMPLETE

### THE BRAND NEW

# T-350XM

RADIOTELEPHONE  
 RADIOTELEGRAPH

## Transmitter

- NO SEPARATE ANTENNA TUNER
- NO PLUG-IN TANK COILS
- NO PLUG-IN TUNING UNITS
- NO INTERNAL VFO ADJUSTING
- ALL FRONT PANEL CONTROL

SPECIFICATIONS:

• 2,000-20,000 KCS • 350 Watts  
 —A1 Output • 250 Watts—A3  
 Output • Built in Master Oscillator • 5 Crystal Positions • Multi Range Impedance Antenna Tuning Network • Manual or High Speed Keying • Uses 2—813 P.A. and 2—805 Modulators Hi-Level Class B • Speech Amplifier, Remote, Mfg. by RCA • Technical Manuals (2) with Each Transmitter • Size 59" x 16" x 24" • Wt —690 Lbs. Net • Power input: 210/250 Volts Single Phase 50/60 Cycles • Brand New—Complete—Unused.

★ ★ ★

This transmitter is similar in characteristics to the RCA Model ET-4336. The T-350XM was manufactured by Technical Radio Corporation, San Francisco, California, for the U. S. Signal Corps. All are new, unused and export cased. Each transmitter carries our guarantee. Spare parts available. Quotations on request.

★ ★ ★

## Communication Devices Co., Inc.

2331 Twelfth Ave.,  
 New York 27, N. Y.

TWX—NY1—223

Cable—Communidev, N. Y.

Tel. Adirondack 4-6174

DYNAMOTORS:

INPUT VOLTS:	OUTPUT VOLTS:	MA:	STOCK NO.	PRICES USED:	NEW:
12 VDC	220	80	DM-34	\$2.95	\$4.95
12	625	225	DM-25	9.95	
12	230	90	PE-133	4.95	6.95
12 or 24	540	450	DA-12	14.95	
12 or 24	230	100	DA-14	8.95	
14	220	70	DM-24	4.95	7.95
14	375	150	BD-83	3.95	4.95
14 VDC	330	150	BD-87	3.95	5.95
14	250	50	DM-25	6.95	8.95
24	250	60	PE-86		8.95
28	1000	350	PE-73	8.95	

RECEIVER-TRANS.—FM 20—28 MC

BC-603 RECEIVER: 20-28 MC variable tuning. 10 Pre-Set push button channels, squelch circuit, 4" speaker; 10 Tubes: 2/12SG7, 2/6SL7, 1/6Y6, 1/6J5, 3/AC7, & 1/6J16. Price: USED: \$29.95  
 PLUG for rear of Receiver: \$1.00  
 DYNAMOTOR: 12 V Input; Output 220 V 80 MA. #DM-34. NEW: \$4.95. REISSUE: \$2.95  
 BC-604 TRANSMITTER: 20-28 MC, 30 Watt, companion to BC-603 Receiver. Crystal control, 10 Pre-Set channels, interphone communication; 8 Tubes: 7/16I9 & 1/16J24. USED: \$18.95  
 PLUG for rear of Transmitter: \$1.00  
 DYNAMOTOR: 12 V Input; Output 625 VDC 225 MA. #DM-35. NEW: \$12.95. REISSUE: \$8.95  
 FT-237 BASE for mounting Receiver & Transmitter (No plugs required) USED: \$9.95

BC-500 RECEIVER—TRANSMITTER: FM Crystal Control on 5 channels, 100 KC separation 20-28 MC. Transmitter: 25 Watt output, 7 Tubes: 1/6J5, 1/12A6, 3/12SJ7, & 2/12SA7. Receiver: 11 Tubes: 1/12SL7, 2/12A6, 3/12SA7, 3/12H6, 2/12K8, & 1/12SJ7. Dynamotor Supply: Receiver 28 VDC 1.2 A Input; output 250 VDC 60 MA. Transmitter 28 VDC 4.1 A Input; output 550 V 120 MA. Control Panel: For local Control & outlets for Remote also. Heavy duty 5" speaker. Size: 12" x 25" x 9 3/4". With Schematic and Conversion. Weight: 65 lbs. Price: NEW: \$59.50

TELEPHONE EQUIPMENT

EE-8 Field Telephone—Ideal for private telephone system for two or more phones, up to 17 miles, hand ringer generator with handset, carrying case, uses two flashlight batteries. Used. Checked: \$14.95  
 New Equipment. Used Cases: \$18.95  
 SOUND POW'D Head & Chest Sets. 1" Checked: \$3.95  
 TS-9 HANDSETS. NEW: \$6.95. USED: \$3.95  
 TS-13 HANDSETS w/PL-55 & PL-68. USED: \$5.95

115 V. 60 CYCLE BLOWERS:



At left: 115 VAC 60 Cycle SINGLE TYPE—100 CFM—2-1/2" intake; 2" outlet. Complete size: 5" x 6" — No. 1C938. \$8.95  
 115 VAC 60 Cycle DUAL TYPE—100 CFM—1" intake; 2" Dis. Each Side. Complete size: 8" x 6" — No. 1C880. \$13.95  
 115 VAC 60 cycle COMPACT TYPE—108 CFM; Motor built inside squirrel cage; 4-1/2" intake; 3-3/4" x 3" Dis. Complete size 4-1/2" W x 8-3/8" H x 8-1/8" D—No. 2C067. \$14.95  
 115 VAC 60 cycle FLANGE TYPE—140 CFM; 3-1/2" intake; 2-1/2" Dis. Complete size: 7-1/2" W x 7-1/2" H x 6-3/4" D—No. 1C807. \$13.95  
 115 VAC 60 cycle FLANGE TWIN—275 CFM; 4-1/2" intake; 3-1/2" x 2" Dis. Complete size: 11-3/4" W x 2-3/8" H x 8-1/16" D. No. 2C069. \$21.95  
 115 VAC 60 Cycle BLOWER—200 CFM; 4" intake; 3" x 5" outlet. Overall size: 8" x 7" x 6". Bodine Motor NS1-33. Removed from New Equipment. #BOD-200. \$14.95  
 115—VAC 60 Cycle BLOWER—100 CFM; 3-3/4" intake; 2" outlet; Rd. Flange with Flap Director. Overall size with bracket: 8" L x 6-1/2" W x 7" H. Removed from New Equipment. Diel Motor FR-2106-6 No. FDIH-2106. \$6.95  
 Same as above, but with 12 Curved Director. No. CD1L-2106. \$7.95

OTHER BLOWERS:

12/24 VDC—AC CAST ALUMINUM BLOWER—100 CFM; 3" intake; 2" outlet. Shunt Motor 4" x 2 3/8" 3000 RPM @ 24 VDC. \$5.95  
 6 VDC SINGLE—100 CFM—No. 6100—USED: \$4.95  
 24 VDC DUAL 20 CFM—Min—No. 2420. \$7.95  
 10 CFM BLOWER—27.5 VDC; 1/100 HP; 7000 RPM; Oster Motor C2BP-1A; L-R Mfg. Co. Bakelite Blower #2—Overall Size: 3 1/2" x 4 1/2". \$5.95  
 Price: \$5.95  
 Same as Above, 12 VDC operation — \$5.95  
 Price: \$5.95  
 115 V. 400 Cycle—10 CFM—Eastern Air Devices Motor J31A—7200 RPM, 1/100 HP, 1-1/4" #2 Blower Ass. Overall Size: 4-1/2" x 3-1/2". No. 3110. \$5.95  
 10 CFM BLOWER—28 VDC, 6A; 5000 RPM, Pioneer Motor SS 2345. Aluminum Blower Housing—overall Size: 4-1/2" x 3-1/2". \$5.95  
 Price: \$5.95

NEW LIST: Write today for FREE New Listing of many, many items!

# FAIR RADIO SALES • 132 SOUTH MAIN ST. LIMA, OHIO



**SAVE ON TUBES BRAND NEW TUBES GUARANTEED TUBES**

OA2	\$ .90	2J61	15.00
OA2WA	3.00	2J62	5.00
OA5	3.75	2K92	13.50
OB2	.60	2K23	12.50
OB2WA	3.00	2K25	15.00
OB3VR90	.85	2K26	45.00
OD3	.60	2K28	25.00
1AD4	1.25	2K33	120.00
ELC1B	1.50	2K33A	60.00
1B22	1.10	2K33B	120.00
1B23	2.75	2K34	85.00
1B24	5.00	2K35	175.00
1B24A	12.50	2K39	100.00
1B26	1.25	2K41	100.00
1B27	10.00	2K42	110.00
1B29	2.50	2K43	110.00
1B32	1.00	2K44	110.00
1B35	3.50	2K45	35.00
1B36	4.00	2K46	200.00
1B40	2.00	2K47	75.00
1B42	4.00	2K48	55.00
1B45	25.00	2K50	175.00
1B47	5.00	2K54	5.00
1B51	6.75	2K56	50.00
1B62	4.00	2X2A	1.00
1B63A	19.50	3AP1	1.50
1D21/SN4	5.00	VR-3B	99.50
1N21B	1.25	3B22	1.50
1N21C	3.00	3B24	1.00
1N23B	1.25	3B24W	5.00
1N23BM	3.00	3B26	3.50
1N23C	2.50	3B29	4.75
1N25	2.20	3C22	60.00
1N26	3.50	3C23	4.00
1N28	6.00	3C24	2.50
1N31	1.90	3C31	1.50
1N32	9.00	3C33	7.50
1N38A	.60	3C45	7.00
1N42	8.00	3DP11A	6.00
1N46	.60	3D21A	3.00
1N52	.65	3E29	8.50
1N63	1.40	3FP7A	2.50
1N69	.40	3J30	35.00
1P21	40.00	3J31	35.00
1P24	1.50	3K22	150.00
1P28	9.00	3K23	150.00
1P30	1.35	3K30	100.00
1V5	.90	4-65A	14.50
1W5	.90	4-125A	19.50
1Z2	1.95	4B23	4.00
2AP1	4.00	4B31	20.00
2AS15	4.75	4C27	7.50
2B24	.80	4C28	25.00
2C33	.75	4C35	13.50
2C35	2.50	4E27	7.50
2C39A	9.50	4J32	45.00
2C39 sealed	11.00	4J34	25.00
2C40	9.50	4J42	25.00
2C42	9.00	4J50	99.50
2C43	9.00	4J52	50.00
2C44	.30	4PR60A	45.00
2C46	6.00	4X150A	20.00
2C50	6.00	5ABP1	20.00
2C51	3.95	5ADP1	20.00
2C52	2.75	5C5B	1.00
2C53	10.00	5BP2A	2.95
2D21	.75	5CP1A	7.50
2D21W	1.00	5CP7A	8.00
2D29	.80	5CP11A	9.50
2E24	3.00	5C22	27.50
2E25	3.75	5JP2	6.00
2E26	3.25	5JP4	6.00
2E27	.60	5JP5	6.50
2E32	1.00	5JP11A	7.50
2H21	85.00	5MP1	2.95
2J31	12.50	5NP1	2.95
2J32	12.50	5R4GY	1.25
2J33	14.50	5R4WGA	4.00
2J34	14.50	5R4WGY	3.00
2J36	12.50	5Y3WGT	1.75
2J48	10.00	6AC7A	1.00
2J49	35.00	6AC7W	1.20
2J50	35.00	6AK5W	1.00
2J54	25.00	6AN5	2.25
2J55	35.00	6AS6W	5725
2J56	40.00	5725	2.70

6A57G	2.50	WE245A	6.45
6AU6WA	2.50	WE-249B	2.50
6BL6	35.00	WE-250-R	3.75
6BM6	35.00	250TH	21.00
6BM6A	40.00	250-TL	12.50
6D4	1.75	WE-251A	49.50
6F4	2.50	WE-252A	7.95
6J4	1.75	QK253	3.00
6J4WA	2.50	WE-254A	9.00
6J6W	1.00	FG-258A	90.00
6K4	2.25	WE-258B	5.00
6SK7W	1.50	V-260	150.00
		VA-6310	150.00
		V-262	150.00

**WE PURCHASE**  
all types of electron tubes,  
tube inventories, contract terminations, etc.  
**HIGHEST PRICES PAID**  
*Write, wire, phone for prompt quotations.*

6SL7W	1.25	FP-265	20.00
6SU7GT	2.75	WE-269A	6.00
6X5WGT	1.25	FG-271	25.00
6X4W	1.00	271A	6.95
SRC-12	200.00	WE-274B	1.00
7C24	90.00	WE-282A	4.00
12DP7	15.00	WE-282B	6.00
12GP7	15.00	WE283A	3.50
FG-17	3.95	QK283A	150.00
RX-21	3.50	QK284A	150.00
PJ22	Q	WE-285A	5.00
HK24	3.00	WE-286A	5.00
26A7GT	3.35	287-A	2.20
26E6WG	3.50	WE-290A	7.00
RK-28A	2.50	GB-302	5.00
BK29D	Q	304TL	12.50
35T	3.00	WE-305A	2.85
D-42	40.00		
RK47	3.00		
V-50	150.00		
V-50XR	150.00		
HK-54	2.00		
QK57	Q		
QK-59	25.00		
QK-60	25.00		
RK-60/1641	1.35		
RK-61	2.50		
QK-62	20.00		
HY-65	1.00		
RK-65/5D23	7.50		
FG-67	12.00		
HY-69	2.50		
RKR-72	.50		
RKR-73	.50		
ML-100	50.00		
100TH	6.50		
WE101D	3.00		
FG-105	11.00		
F-123A	2.50		
F-128A	10.00		
FG-154	10.00		
VT158	9.75		
FG-166	6.75		
FG-172	20.00		
QK-181	25.00		
HF-200	12.50		
WL-200	75.00		
204A	25.00		
205F	6.00		
207	75.00		
211 VT4C	.50		
212E	15.00		
WL-218	15.00		
QK221	150.00		
FG-235	60.00		
QK235	Q		
QK-243	50.00		
QK-249	150.00		

WE-418A	18.00	WE-421A	7.00
WE-422A	10.00	WE-423A	5.75
WE-428A	40.00	GL-434A	5.00
WE-438A	40.00	446B	1.00
WL-456	59.50	464A	1.95
X-481D	149.50	CK501AX	1.00
RH-507	20.00	527	22.50
583	2.00	583	2.00
KU-610	3.50		

717A	.50	5634	6.50
720AY-EY	35.00	5636	3.00
721A	.75	5639	7.00
721B	7.00	5639A	7.00
722A	.75	5644	7.25
723A B	8.50	5647	5.00
725A	3.00	5651	1.40
726A	7.00	5654	1.50
726B	15.00	5656	7.00
726C	15.00	5657	125.00
730A	7.50	5663	1.25
750TL	35.00	5665	35.00
801A	.35	5667	125.00
802	2.00	5670	2.00
803	2.00	5675	7.00
804	9.00	5683	5.75
807	1.20	5687	3.00
807W	2.00	5691	5.00
808	1.00	5692	5.00
809	2.25	5693	4.50
811	2.90	5702	1.50
812A	3.50	5703	.90
813	9.50	5704	1.60
814	1.35	5718	3.00
815	1.50	5719	2.50
828	8.50	RK-5721	150.00
829	5.00	5725 6AS6W	2.75
829B	8.50	5726 6AL5W	.60
830B	.50	5744	1.90
832A	6.00	5749 6BA6W	1.25
834	5.00	5750	3.00
836	1.50	5763	1.30
838	.70	CK-5787	4.95
842	1.50	5814	.80
845	4.00	5819	35.00
846	125.00	5825	7.95
849	17.50	5829	1.00
851	8.00	5837	50.00
852	4.00	5840	4.50
861	15.00	5841	6.00
865	.90	5844	1.50
872A	1.35	5851	4.00
884	1.00	5852	6.00
GL-889	35.00	5876	8.00
GL-889A	50.00	5879	1.25
902A	2.00	5893	9.00
902P1	2.00	5896	5.00
905	3.00	5899	5.00
917	1.50	5902	5.50
919	1.50	5902A	5.50
922	2.00	5906	11.00
927	1.00	5915	.80
931A	3.50	5932	4.00
935	4.00	5933 807W	4.00
957	.35	5956	35.00
958A	.35	5981	90.00
959	1.25	5982	149.50
991	.35	5987	9.50
CK-1005	.35	6005 6AQ5W	1.95
CK-1006	3.75	6021	4.50
CK-1007	.45	6021-A	6.00
1229	2.75	6028 408A	2.00
1603	3.50	6037 QK243	75.00
1614	1.50	6044	15.00
1620	3.00	6046	.75
1622	2.00	CK-6050	2.00
1623	1.25	6081	
1624	1.00	ATR407	22.50
1625	.30	6096	1.50
1626	.25	6099	1.40
1631	1.25	6100 6C4WA	2.25
1636	.75	6111	6.00
1641	1.35	6112	6.50
1945	65.00	6130	7.50
2000T	150.00	6136	2.50
2050	1.00	6147	3.00
2051	.65	6159	3.00
HK3054	150.00	6177	49.50
ZB3200	99.50	6203	2.75
4210	Q	6205	6.00
R-4330	9.00	6211	1.50
R-4340	9.00	VA-6310	
5516	5.50	V260	149.50
5517	1.50	8002R	15.00
5551/FG271	35.00	8012	1.00
5553		8025A	2.00
FG258A	90.00	9001	.85
5559 FG57	10.00	9002	.55
5586	125.00	9003	1.00
5591 403B	2.75	9005	1.50
5611	65.00	D178461	50.00

THIS IS ONLY A PARTIAL INVENTORY

CHECK WITH US FOR YOUR REQUIREMENTS

Thousands of other types in stock. Send us your requirements. RECEIVING TUBES! We Carry a complete line in stock. Standard brands only.

**ELECTRONICS**  
 Dept. B-10  
 1108 Venice Blvd  
 Los Angeles 16  
 California

All prices F.O.B. Los Angeles, subject to change without notice. Minimum order \$5.00. Check with us for items not listed.

# SOLO

Receiving Types		
680	1A4G	.62
500	11A4	.45
600	3Q4	.38
900	5Z4	.92
500	6AC7W	.75
600	6AK5	.65
3,300	6AK6	.55
800	6AN4	.65
400	6AS5	.47
800	6BQ7A	.89
1,000	6SK7	.48
1,600	6V6GT	.45
1,900	12AU6	.44
800	12A7	.40
400	12A6	.38
300	12AY7	1.00
600	12SG7	.65
700	25L6Gt	.50
SPECIAL		
4,500	25L6GT (Tung-Sol Jobber Boye) Late Date @ 55c	
610	30	.35
400	70L7	1.10
400	5642	.72
Branded "Rogers-Canada" Many of US Mfrs		
1,000	1A7	.44
300	11A6	.68
1,200	1S5	.42
300	1V6	.70
1,500	5X4	.35
700	6A8	.68
800	6J5GT	.40
300	6K7GT	.40
300	6L7	.78

## TUBES

200	607	.72
4,000	7B6	.42
1,700	7C6	.52
4,000	7Q7	.62
3,000	7Y4	.46
700	14Q7	.58
400	25Z6	.45
1,000	35L6GT	.49
8,000	35Y4	.46
2,000	35Z4	.32
Transmitting Types		
1,000	1B32	.35
600	2C40	8.25
600	5R4GY	1.10
60	35TG	1.95
30	90NB	15.00
125	11F120	3.25
200	11F140	4.50
45	21B	20.00
50	250TL	10.95
50	250TH	23.75
2,000	440A	37.50
6	450TL	45.00
160	468	12.00
300	707A	1.50
1,000	722A	.35
50	725A	1.75
2,000	807	1.10
400	807W/5933	1.95
50	808	.75
200	813	9.00

700	830B	1.25
330	843	.25
150	851	4.95
400	864	.23
200	865	.25
150	902PL	1.50
500	958A	.39
3,000	1625	.29
9,000	1629	.26
700	5783	2.45
1,500	9002	.62
2,000	9003	1.35
30	AX9903/5894	18.50
600	9004	.25
Diodes		
5,000	1N38A	.35
300	1N54	.65
1,000	1N58A	.32
500	1N86	.25

### CANADIAN-MARCONI

Most Jobber Boxed			
10c Special	Also		
1B5	1F7G	19¢	
1B7Gt	1G5G	1J6G	25¢
1C6	33	3A8Gt	25¢
1D7	36	6B8G	35¢
1E5GP	38	6R7	42¢
1F6	39	12A	12¢
		12Q7Gt	30¢
1st Quality—Canadian—Unbranded			
10,000	1A4P	8¢	
10,000	1D5GP	20¢	
15,000	19	11¢	
2,000	46 J	19¢	

A GEM OF A BUY!—SHALLCROSS KILOVOLT METER Limited Quantity! Act Now!

#### BRAND NEW

No. 760, Portable D-C Model  
Multiple Range 5-10-20-KV

Made expressly for the University of California, Los Alamos Scientific Laboratory

#### SPECIAL ADDITIONAL FEATURES

1. Normal and reverse polarity switching
2. External metering binding posts
3. Metering switch for both internal and external measurements
4. 4 1/2" micrometer
5. May be used for measuring AC with external meter

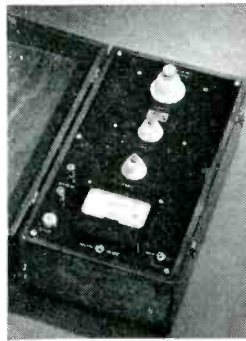

Sturdy industrial oak carrying case beautifully finished; precision resistors used throughout; steatite insulation and best grade bakelite engraved panel.

Instruction sheet attached to lid of case  
Case Dimensions: 18 3/8" x 10 1/2" x 9 3/8"  
Low current consumption (not more than 1 ma. at full scale)

Completely self-contained design  
Accuracy at full scale—+ or -2% for D-C.

Rugged design for use as fixed and portable instrument for field, laboratory, or shop use.

**Regular Price about \$255.00  
NOW ONLY \$89.50**

## ELECTRONIC SALES CORPORATION

190 Washington St.  
Louis H. Grossberg

New York 7, N. Y.  
Worth 2-1042

### TIME DELAY RELAYS

Haydon 115v 60 cy. adj. in 5 sec. steps to 40 sec. spdt mu sw. \$6.95. With 2 arms & 2 sw. .... \$9.95  
Haydon 5901-2, to 1 min. in .1 min. steps. .... \$7.95  
RELAYS: many types in stock—inquiries invited.  
We wish to buy your surplus timers, relays, etc.

EMPIRE ELECTRONICS COMPANY  
74 Cortlandt St., N. Y. 7, N. Y. Worth 2-5272

### Special Purpose AND Transmitting Tubes

CAP ELECTRONICS, INC.  
83 Warren Street New York 7, N. Y.  
REctor 2-8078-9

### TERRIFIC BUY—BRAND NEW FREQUENCY METERS TS-175

85 to 1000 Mcs.  
Calibration Accuracy: .005%  
Stability: .0025%, Resettability: .0025%  
• Precise Measurements of Frequencies  
• A Secondary Frequency Standard  
• Signal Generator Calibration  
End of Factory Run  
ALLAN AIR PRODUCTS CORP.  
HICKSVILLE, N. Y. WELLS 8-0500

### FOR EXPORT ONLY

We offer:

- RECEIVING, TRANSMITTING & SPECIAL PURPOSE TUBES
- RADIO & TELEVISION SETS & PARTS—TESTING INSTRUMENTS
- CATHODE RAY TUBES—TRANSISTORS & DIODES—WIRE & CABLE
- PROJECTOR, REFLECTOR, GERMICIDAL & OTHER TYPE OF LAMPS
- FLOUORESCENT LAMPS—BALLASTS & STARTERS
- ELECTRICAL APPLIANCES—HOUSEHOLD & BATHROOM SCALES
- HEARING AID BATTERIES—TAPE RECORDERS & TAPE

All merchandise direct from outstanding U. S. Manufacturers—Original Packing—No Surplus or distressed lots—We take care of Export Formalities for account of Foreign Customers. WILL QUOTE AGAINST SPECIFIC REQUEST.

Tel. Circle 6-0375  
Cable: MILANBROS,  
New York

## MILANO BROTHERS

250 West 57th Street  
New York 19, N. Y.

### AVIATION SURPLUS MATERIALS

Catalog listing well over a thousand Air-craft accessories, parts, materials, etc. Electrical, hydraulic, air, etc. Each item priced, with part number, description. Please write:

**AERO PARTS SUPPLY**  
Dept. E, 8102 Lockheed St.,  
Houston 17, Texas

Special Purpose Tubes

TUBES

Receiving Tubes

- All fully guaranteed!
Ready for shipment!
Save up to 90%!

Table listing Special Purpose Tubes with part numbers and prices.

WRITE-WIRE or PHONE for: POWER SUPPLIES RADAR PARTS - METERS - TUBES TEST SETS TELETYPE AIRBORNE ELECTRONICS NAVIGATION AIDS

TN-1/APR-1 TUNING UNIT Receives and converts 38-80 MC RF to 30 MC IF. Requires only 250 V. B- and 6.3 VAC for heaters.

FREQUENCY METER AND TEST OSCILLATOR! 115 V., 50-800 cy. power supply. In freq. meter section, crystal oscillator beats VFO.

VARIABLE VOLTAGE AMERTRAM TRANSTAT. 11.5 KVA. Input 115 V., 60 cycles. Output continuously variable 0 to 115 V. up to 100 amperes.

X-BAND DO-ALL TS-146/UP. Radar Test Set. 9285-9485 mc. F-M 723A/B osc., attenuators - freq. meter, thermistor bridge, sawtooth generator, etc.

NEW ARRIVALS! All unused! Excellent condition! TS-3/AP \$95.00 TS-3A/AP \$125.00 TS-92/AP \$75.00

ARROW SALES, Inc.

OFFICE AND MAIN WAREHOUSE: 7460 VARNA AVE., NORTH HOLLYWOOD, CAL. Mail to: BOX 3007-E, NORTH HOLLYWOOD, CAL. Phones: Stanley 7-0406 Poplar 5-1810

Table listing various tube types and prices, including 5840, 5840A, 5895, 5902, etc.

Table listing Receiving Tubes with part numbers and prices, including 601A, 602A, 6A5, 6AT6, etc.

SCOPE TUBES 2AP1 \$5.75 SCP1 4.00 7BP7 6.50 3AP1 5.00 SCP7 7.00 9GP7 8.50

SEMI-CONDUCTORS 1N21 \$5.50 1N27 5.00 1N69 .65 1N21B 1.75 1N31 6.48 1N70 .75

SPECIAL 6SH7 metal 39¢ ea.

Write for tubes not listed. Get our quotes on quantity orders. We deliver anywhere. Min. order \$5.00. All items subject to prior sale and change of price without notice.



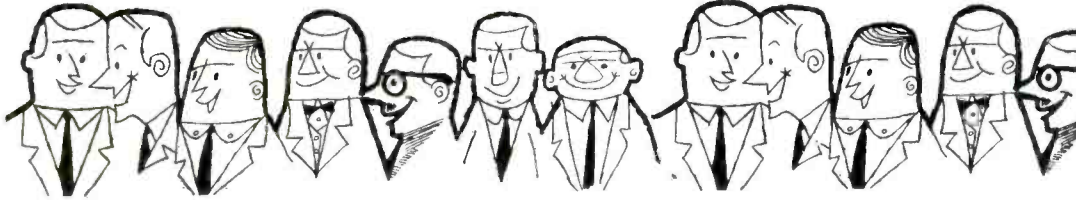

# LARGEST STOCK OF RELAYS IN THE WORLD

PRODUCTION QUANTITIES IN STOCK • FAST DELIVERY FROM OUR STOCK

## WESTON Model 705 SENSITROL



Stationary contact is a small powerful permanent magnet and movable contact is iron "rider" mounted on pointer which travels over relay scale. Operating torque moves pointer into magnetic field of stationary contact which draws movable contact and holds it firmly. Contacts remain closed until reset. Will operate directly from a photocell or a group of thermocouples. Net weight 14 oz.

**#R561**  
Double contact with Solenoid Reset; Sensitivity 7.5 Microamps; Reset coil 6-24 VDC or 24 VAC; Makes contact on increasing or decreasing values; Contacts; "Twintacts", Capacity 100 ma at 110 volts; Nickel plated brass cover; Weston Model 705 Type 6 #R560 ..... **18.75\***  
Same as #R560 but with glass face; Weston Model 705 Type 6 #R561 ..... **19.75\***  
Single contact (Normally Open). Solenoid Reset; Sensitivity; 10 Microamperes; Reset coil; 6-24 V DC or 24 V AC; Contact: "Twintact", capacity 100 ma at 110 volts; Glass Face; Weston Model 705 Type 4 #R523 ..... **17.75\***  
Same as #523 with Brass Cover Weston Model 705 Type 4 #R523N ..... **16.75\***

## SS5

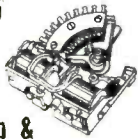

## STEPPING SWITCHES

Mfd. by Western Electric  
Minor Switch 10 steps and off Contacts: #'s R960, 975, 976 Gold plated brass; Bridging Wiper; others non-bridging; Net. Wt. 1 lb.

Each\*  
#R960; Single Level; 6 to 12 VDC ..... **9.50**  
#R975; Single Level; 24 to 36 VDC ..... **10.50**  
#R976; Single Level; 48 to 60 VDC ..... **11.50**  
#R643; Single Level; 100 to 125 VDC ..... **12.50**  
#R977; Two Level; 6 to 12 VDC ..... **10.50**  
#R978; Two Level; 24 to 36 VDC ..... **11.50**  
#R979; Two Level; 48 to 60 VDC ..... **12.50**  
#R644; Two Level; 100 to 125 VDC ..... **13.50**  
#R642; Three Level; 6 to 12 VDC ..... **11.50**  
#R600; Three Level; 24 to 36 VDC ..... **12.50**  
#R645; Three Level; 48 to 60 VDC ..... **13.50**  
#R646; Three Level; 100 to 125 VDC ..... **14.50**

## SS6

Mfd. by Western Electric Co.; 22 step; 5 levels; Bridging Wipers; Contacts; Gold plated brass. Interrupter Switch; 1 Break-Make; Net Weight: 2 lb. 2 oz. "Homing" Type; 180° Wipers; Step in One Direction

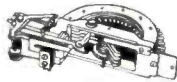

Each\*  
#R926; 6 to 12 VDC ..... **13.75**  
#R980; 24 to 36 VDC ..... **14.75**  
#R981; 48 to 60 VDC ..... **15.75**  
#R616; 90 to 120 VDC ..... **16.75**

## SS7

Mfd. by Western Electric Co.; 44 step; 2 Levels; Bridging Wipers; Contacts: Gold

plated brass; Interrupter Switch; 1 Break-Make; Net Weight 1 lb. 14 oz. "Homing" Type; 360° Wipers; Step in One Direction

Each\*  
#R927; 6 to 12 VDC ..... **13.75**  
#R982; 24 to 36 VDC ..... **14.75**  
#R983; 48 to 60 VDC ..... **15.75**  
#R616; 90 to 120 VDC ..... **16.75**

**CLARE TYPE 20** "Homing" type; Step in one direction; 20 position; 180° wipers, one bridging and remainder non-bridging; Interrupter Switch; 1 break. #R891; 24-36VDC; 3 levels; Clare #SD19. **12.95 each**

## LATEST HERMETICALLY SEALED SUBMINIATURE TYPES

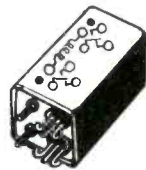

### SIGMA 22RJ 5P & DP SUBMINIATURE TYPES

Light weight; Extremely small; Hermetically sealed in solder dipped brass can; 3 oz max weight. Silver contacts rated at 2 amp; solder lug connections.  
**22RJA200G**: 10.0 ma operate, 3.5 ma release; 1A; 200 ohm; #R618 ..... **7.50\* ea**  
**22RJCC5000G**: 2.8 ma operate, 1.0 ma release; 2C; 5000 ohm; #R619 ..... **9.50 ea**  
**22RJCC8000G**: 2.3 ma operate, 0.8 ma release; 2C; 8000 ohm; #R617 ..... **9.50\* ea**

## ALLIED 50G MH MULTIPOLE TYPES



Developed to meet spec MIL-R-575A; 18-30VDC; Hermetically sealed; -55°C to +85°C; 50G for 11 milliseconds. Contact rating 2 amp. Solder lug connections.  
**MH18DT**: 26.5 VDC; 6PDT (6C); 240 ohm; 4.2 oz; Operate time: 8 millisecc, release: 5 millisecc. Mounting plate opposite terminals; #R647 ..... **7.50\* ea**  
**MH18D**: Same as R647 above but mounting plate on same side as terminals (As illustrated); #R648 ..... **7.50\* ea**  
**MH12D**: 26.5 VDC; 4PDT (4C); 300 ohm; 2.9 oz; Operate time: 7 millisecc, release: 5 millisecc; #R649 ..... **7.00 ea**  
**MH6D**: 26.5 VDC; DPDT (2C); 400 ohm; 1.2 oz; Operate time: 6 millisecc, release: 5 millisecc; #R665 ..... **6.00 ea**  
**STRUTHERS DUNN 220NFX100**: (Similar to Allied MH18D); 26.5 VDC; 6PDT (6C); 240 ohm; 3 oz; #R1145 ..... **7.50\* ea**

## FILTORS, INC.

Developed to meet spec MIL-R-5757B; 4 to 9 VDC. Hermetically sealed; -65°C to +125°C; 50G for 11 millisecc; contact rating 3 amp. Solder lug connections.  
**609A**: 6.3 VDC; 3PDT(3C); 42 ohm; 2.8 oz; #R669 ..... **6.50 ea**  
**26SA12A**: Developed to meet spec MIL-R-575A; same as Allied MH12D; 26.5VDC; 4PDT(4C); 250 ohm; 2.3 oz; solder lug header; #R670 ..... **7.00 ea\***

## ADVANCE F & S SERIES



Light weight; compact; versatile relays for multitude of applications.  
**F2A C8726-1**: 9.5VDC; SPDT (1C); 200 ohms; Solder lug header; #R666 ..... **5.95 ea**  
**F2A C8727-1**: 18-30VDC; DPDT (2C); 500 ohm; Solder lug header; #R664 ..... **5.95 ea**  
**S2A D8701-1**: 48VDC; DPDT (2C); 2000 ohms; Solder lug header; #R667 ..... **5.95 ea**  
**S2A C8720-1K**: 28VDC; SPDT(1C); 500 ohms; Solder lug header; #R668 ..... **5.95 ea**

\*Prices shown with asterisk (\*) are subject to quantity discounts listed above.

**ALL MERCHANDISE IS GUARANTEED AND MAY BE RETURNED FOR FULL CREDIT.**

SEND FOR LATEST CIRCULAR. TERMS:—All Prices F.O.B. Our Plant. Rated Firms Net 10 Days; All Others Remittance with Order. Orders Under \$10.00 Remittance with Order, Plus Approximate Shipping Charges (Overage Will be Returned).

Cable address: UNIGENCOR, N. Y.

Third International  
**AUTOMATION**  
Exposition  
**'56**  
NEW YORK  
NOVEMBER 26-30  
New York Trade Show Building  
500 Eighth Avenue, N.Y.C.  
"the show of the future"

We are exhibiting at  
**BOOTH 121**

Prices listed with asterisk (\*) are subject to  
**QUANTITY DISCOUNTS**

1-9	as quoted	50-99	15%
10-49	10%	over 100	20%

## POTTER BRUMFIELD

**SM5LS**: 3 ma; SPDT(1C); 10,000 ohm; 3/4" Dia x 1 1/4" H. Fits standard 7-pin miniature tube socket; #R1008 ..... **3.95 ea**

## MAGNETIC CLUTCH

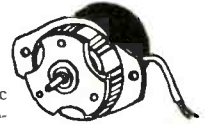

Double acting magnetic clutch; rated for operation on 24VDC; 125 ohms; 200 ma. Pulls in at 18 VDC, drops out at 5 VDC. Tooth clutch assures positive coupling. Torque capacity 12 in.-lbs. An extra output shaft and a concentric flange are engaged with power off. When power is applied, flange disengages and shaft can rotate freely while coupling engages shafts through the unit. Flange can thus be used as a quick acting brake on output shaft.

Of ball-bearing construction, can operate at high speed. Suited for precision use as backlash and play are zero. Stainless steel output shaft 3/16 dia. x 1/2" long. Bronze input shaft 5/16 dia. x 3/8" long. Concentric flange, 1-5/8 dia. x 3/16" thick with 3 equally spaced tapped holes for coupling. Aluminum body 1-7/8 dia. x 2" long, exclusive of shafts. Mounting flange at output end. Shipping Wt., each 5 lb.  
#MC101 ..... **\$6.50\* ea.**

## GEARS

Bronze Gear For Input Shaft 1-5/8 D 80 teeth #G101 .35\* ea.  
Bronze Gear For Flange 3-1/4 D 144 teeth #G102 .60\* ea.  
Stainless Steel Gear For Output Shaft 1" D 48 teeth #G103 .30\* ea.

See quantity discounts above

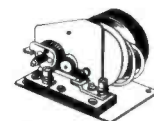

## KURMAN TIME DELAY

**R300**, motor driven 110V 60 cycles; continuously adjustable delay 10 to 60 seconds; SPST(1A); #R671 ..... **7.95\* ea.**

**SAVE UP TO 70% OF WHOLESALE COST**

**COAXIAL CONNECTORS**

PL-259.....	\$.40	UG-87/U.....	\$.40
SO-239.....	\$.40	UG-88/U.....	\$.65
M-359.....	\$.30	UG-146/U.....	1.75
UG-21B/U.....	\$.85	UG-201/U.....	1.50
UG-27/U.....	\$.65	UG-255/U.....	1.70
UG-29/U.....	\$.75	UG-260/U.....	\$.65
UG-58A/U.....	\$.75	UG-273/U.....	1.10
UG-83/U.....	1.50	UG-274/U.....	1.95
UG-85/U.....	\$.45	UG-290/U.....	\$.65

Complete Listing of Factory Fresh JAN Approved Connectors Available at Similarly Low Prices !!

**TYPE J POTENTIOMETERS**

Full Range of Values Available From Stock for Immediate Delivery

Single Type J Units	\$ .95 Ea.
Dual Type JJ Units	3.95 Ea.
Triple Type JJJ Units	3.95 Ea.

SEND FOR COMPLETE LISTING

**PRODUCTION QUANTITIES**

**GAS ENGINE DRIVEN 1/8AC GENERATOR ONAN MODEL OFA-2**

**GENERATOR**-110v - 60cy 1ph 41KW.  
**GAS ENGINE**-4 CYL - 8 HP Air Cooled  
Battery Ignition Electric or Cord Starting  
—Fuel Tank 4 gals.—Complete with 12V  
Battery—400 Lbs. **\$395.00 Complete**

**HI CURRENT FILAMENT TRANSFORMERS**

**Amertran type W**-PRI-105-125v 60cy 1 ph-SEC. 5v. 190amp. **Ea. \$29.50**  
**KENYON S-149**10-PRI-105-125v 60cy 1ph-SEC. 5v 115amp **Ea. \$19.50**  
**MIL-T-27 type**-PRI-115/230v 50/60 cy.-SEC. 5V 10 AMP **Ea. \$6.25**

**ALL COMPONENTS 1ST QUALITY AND 100% GUARANTEED**

**TUBES**

NEW—COMPLETELY GUARANTEED

750 TL  
**\$19.95 Ea.**

807 W  
**\$1.75 Ea.**

FG-172  
**\$15.00 Ea.**

FULL LINE OF RECEIVING TUBES—POWER TUBES, MAGNETIONS, KLYSTRONS, CRYSTAL DIODES AVAILABLE AT SIMILARLY LOW PRICES

**IMMEDIATE DELIVERY**

**CONSTANT VOLTAGE TRANSFORMERS**

**2000 VA-SOLA #30768**  
PRI-95-125/190-250V 50/60 cy.  
SEC-115 V 1% Regulation 2000 VA **\$95.00 Ea.**

**400 VA-THORDARSON T47176**  
PRI-95-130V. 60 cy 1 ph.  
SEC-115V. 1% Regulation 400VA  
Encl. Case supplied with external capacitors **\$27.50 Ea**

**SOUND POWERED PHONES**

**US NAVY Type "M"** Head and Chest sets  
Heavy Duty-incl. Headset, Chest Mike & 20 ft. of cord **\$14.88 Ea.**  
**TS-10 type S. P. Handset** **\$9.48 Ea**

**Terms:** 20% cash with order, bal. C.O.D. unless rated. All prices net F.O.B. our warehouse Phila., Pa. subject to change without notice.

**Special Discounts on Quantity Purchases**

**WE INVITE YOUR INQUIRIES FOR ALL YOUR ELECTRONIC NEEDS**

**SYNCHROS COMPLETE LINE OF COMMERCIAL ARMY AND NAVY TYPES IN STOCK !!**

1CT.....	\$37.50	SSDG.....	\$12.50
1UCT.....	42.50	SSF.....	29.50
1F.....	37.50	SSG.....	29.50
1G.....	37.50	6G.....	34.50
3D.....	62.50	6DG.....	27.50
3HCT.....	62.50	6HG.....	42.50
5B.....	22.50	7G.....	42.50
5CT.....	34.50	7DG.....	47.50
5HCT.....	42.50	23CT6.....	45.00
5F.....	34.50	23CX6.....	45.00
5G.....	34.50	21F1.....	4.95
5N.....	22.50	21G1.....	3.95

MANY OTHER TYPES IN STOCK QUOTATIONS ON REQUEST.

**PULSE TRANSFORMERS OVER 50 TYPES LOW AND HIGH POWER TYPES IN STOCK FOR IMMEDIATE DELIVERY**

MFD. BY UTAH, G.E., RAYTHEON, PHILCO WESTINGHOUSE, WESTERN ELECTRIC, ETC.

132AW2F.....	7P1	\$6.95
134BW2F.....	7P4	6.95
176AW2F.....	7P10	7.50
139DW2F.....	7P13	5.95
148DW2F.....	7P15	7.60
Utah X12472-9262.....		12.50
Utah X139T1-9278.....		3.75
G.E. 68G828.....		14.50
G.E. 68G627.....		16.50
Raytheon UX7361A.....		3.95

SEND US YOUR INQUIRIES

**POLYSTYRENE CAPACITORS**

1% Tolerance  
200VDCV..... 500VDCT  
HERMETICALLY SEALED  
0.5MFD..... \$7.50 Ea.  
1 MFD..... 12.10 Ea.  
MFD BY W.E. BRAND NEW

**FROM ONE OF THE LARGEST INVENTORIES IN THE U.S.A.**

**TEST EQUIPMENT**

**GENERAL RADIO**

GR 107K Var. Inductor.....	*\$35.00
GR 107N Var. Inductor.....	*\$35.00
GR 222L Precision Condenser 1500MMF	* 55.00
GR 510A Decade Res.....	5.00
GR 572B 1KC Hummer.....	7.50
GR 668A Decade Res.—1 Q Steps.....	6.50
GR 668B Decade Res.—1 Q Steps.....	7.50
GR 700P1 Volt. Divider.....	27.50
GR 713S Heat Freq. OSC.....	*\$25.00
GR 715 AE DC Amplifier.....	225.00
GR 720A Hot. Freq. Meter.....	275.00
GR 722N Precision Capacitor.....	*\$95.00
GR 723C VT Fork 1KC.....	89.50
GR 726A VTVM.....	*\$85.00
GR 727A VTVM (Battery Oper.).....	*\$105.00

**HEWLETT-PACKARD**

HP 200B Audio Osc.....	*\$75.00
HP 325B Distortion Analyzer.....	*\$220.00
HP 400A VTVM.....	*\$95.00

Measurements Corp 79B—Pulse Generator	\$165.00
Waterman Ralscope—Model S-12-B 3" Scope.....	\$325.00
Dumont 208 Oscilloscope.....	\$9.00
BC-221 Freq. Meter.....	\$125.00
LAE-1 Signal Gen. (510-1300 MC).....	\$225.00
LAG Signal Gen. (1200-4000 MC).....	\$375.00

TS Types and Microwave Test Equipmen and Components in Stock  
All items new except where noted \*(Excellent Used—Guaranteed)

**ELECTRONIC RESEARCH LABORATORIES**

15-19 Arch St., Phila. 6, Pa. • MArket 7-6771-2-3  
Cable Address: ELECTRONIC, PHILADELPHIA

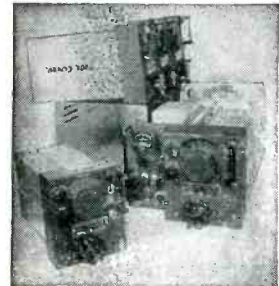

**AN/APR-4 LABORATORY RECEIVERS**

Complete with all five Tuning Units, covering the range 38 to 4,000 Mc; wideband discone and other antennas, wavetraps, mobile accessories, 100 page technical manual, etc. Versatile, accurate, compact—the aristocrat of lab receivers in this range. Write for data sheet and quotations.

We have a large variety of other hard-to-get equipment, including microwave, aircraft, communications, radar; and laboratory electronics of all kinds. Quality standards maintained. New Reduced Prices On:  
**NEW TS-13/AP X-BAND SIGNAL GENERATORS with manual;**  
**T-47A/ART-13 Transmitters;** H-P, Boonton, G-R, Measurements, many others in stock.

**ENGINEERING ASSOCIATES**

434 PATTERSON ROAD

DAYTON 9, OHIO

**G.E. Industrial TUBES FOR SALE AT TERRIFIC DISCOUNT**

5965-6211-2D21-5844  
All 4 numbers \$1.00 ea. net  
G.E. Tubes guaranteed 1st Quality Boxed.

We purchase all types of tubes, inventories, Contract Terminations, etc.

**DUTCHESS LABS**

38 Catskill Ave. Poughkeepsie, New York  
Phone POK-5944

**RELIABLE TUBES**

1B60.....	22.00	2K48.....	65.00	BL26.....	15.00	451/8020.....	1.75	5588.....	80.00	5879.....	1.00	6112.....	6.00
1CP1.....	12.00	2K50.....	150.00	FG27A.....	12.00	681/5550.....	20.00	5636.....	3.00	5893.....	15.00	6115A.....	90.00
1P22.....	6.50	2K56.....	60.00	FG33/5720.....	15.00	714AY.....	25.00	5639.....	9.00	5894.....	20.00	6116.....	200.00
1P25.....	65.00	KC4/5625.....	50.00	OK51.....	110.00	715B.....	3.75	5641.....	5.00	5896.....	5.00	6161.....	55.00
1P28.....	8.00	4J31.....	60.00	FG67/5728.....	15.00	723A/B.....	7.00	5657.....	95.00	5899.....	5.00	6167.....	25.00
1P41.....	1.50	4J33.....	55.00	RK71/6D21.....	160.00	726C.....	20.00	5675.....	10.00	5901.....	7.50	6177.....	90.00
1P42.....	7.00	4J52.....	70.00	OK103.....	90.00	804.....	8.00	5692.....	4.75	5902.....	4.75	6181.....	375.00
2J30.....	40.00	4J61.....	125.00	OK181.....	25.00	807.....	1.25	5702.....	1.75	5906.....	12.00	6199.....	30.00
2J36A.....	90.00	6A8GT.....	.60	OK185.....	75.00	807W/5933.....	3.00	5744.....	1.25	5976.....	40.00	6247.....	15.00
2J54B.....	65.00	6AJ5.....	1.25	VA221H.....	245.00	813.....	9.00	5763.....	1.40	5981.....	75.00	6263.....	15.00
2J64.....	175.00	6AN5.....	2.00	OK202.....	200.00	828.....	10.00	5764.....	45.00	6021.....	4.00	6326.....	400.00
2K25.....	15.00	6BL6.....	32.50	250TL.....	15.00	829B.....	8.00	5777.....	220.00	6032.....	150.00	6383.....	70.00
2K26.....	45.00	6BM6.....	37.50	261A.....	10.00	832A.....	6.00	5794.....	6.95	6034.....	7.00	6385.....	20.00
2K29.....	40.00	6BM6A.....	50.00	268A.....	6.00	CK1026.....	3.00	5819.....	35.00	6035.....	30.00	6524.....	15.00
2K39.....	95.00	6SK7W.....	1.25	339A.....	7.00	R1111.....	3.50	5838.....	6.00	6037.....	100.00		
2K40.....	90.00	6X5WGT.....	1.25	352A.....	20.00	R1131C.....	10.00	5851.....	4.00	6038.....	10.00		
2K41.....	100.00	7F8W.....	3.50	OK381.....	75.00	1690.....	3.00	5852.....	6.00	6096.....	1.75		
2K45.....	45.00	12AT7WA.....	2.75	412A.....	1.75	R4340.....	25.00	5857.....	30.00	6101.....	2.50		
2K47.....	95.00	BL17.....	7.50	416B/6280.....	40.00	5563.....	30.00	5876.....	11.50	6111.....	5.00		

All mdse guaranteed. 24-hour telephones take your orders anytime for prompt servicing. Material subject to prior sale.

**PAGE ELECTRONICS**

136 Liberty Street

CORtlandt 7-4245

New York 6, N. Y.

**ENGINEERING DEGREES**  
(Under and Postgraduate)

E.E. Option in Electronics  
Earned Through Home Study.  
Residential Courses Also Available  
**AMERICAN COLLEGE OF ENGINEERING**  
Box 27724(G), HOLLYWOOD 27, CALIF.

**ART-13 APR-4 BC-610-E**

BC-348, BC-312, BC-342, TCS, BC-221,  
TS-173, ARC-1, APR-SAX, RTA-1B  
FRA Teletype Converters (RCA)

**ALLTRONICS,**  
Box 19, Boston 1, Mass. Richmond 2-0048

**WANTED**

**WANTED**

ART-13/T47A Transmitters \$175.00	BC-348 Rec'r Modified \$25.00
ART-13/T47 Transmitters \$125.00	BC-348 Rec'r Unmodified \$30.00
BC-788C Alt. \$175.00	ARC - I Transceiver \$300.00
ARC - 3 Transceiver Complete \$325.00	BC-342 Rec'r \$30.00
R5/ARN-7 Radio Complete \$175.00	BC-312 Rec'r \$40.00
Ship via Express, C.O.D. Subject to Inspection to H. FINNEGAN, 49 Washington Ave. Little Ferry, N.J.	I-152C Ind. \$90.00

**"WANTED NEW SURPLUS RADIO TRANSMITTING TUBES**

Any Quantity Types 893, 898, 852, 857"  
**Trans-International Forwarders, Inc.**  
82 Beaver St., New York 5, N. Y.  
Whitehall 3-6257

**SELL YOUR WAY TO WEALTH!**

**WANTED-SURPLUS MILITARY AND COMMERCIAL AIRCRAFT ELECTRONICS:** BC-788... I-152... ARN-7... ARC-1... ARC-3... transmitters... receivers... test equipment... etc.  
**WANTED-ELECTRONIC TUBES:** Broadcast... transmitting... receiving... Magnetrans... Klystrons... miniature... sub-miniature... ruggedized... etc.  
**TOP PRICES PAID! FOR FATTEST CHECKS-SELL TO REX!** R. E. SANETT, W6REX, 1524 S Edris Drive, Los Angeles 35, Calif. Phone: REpublic 5-0215... CRestview 1-3856.

**MISCELLANEOUS**

**Magnetic Precision Controls, Inc.** is the sole owner of the inventions subject to applications for Letters Patent bearing serial Nos. 366,161, 378,980, 385,580, 401,553, 402,070, 419,677, 419,730, 436,267, and 436,015 and French Patent applications Nos. 680,001, 680,002, 681,038 and British Patent Applications Nos. 32,065/54, 32,066/54, 32,067/54 and 32,068/54, listing Michel Mamon as inventor, and comprising low-level magnetic amplifiers, high speed magnetic amplifiers, constant current devices, battery chargers, magnetic modulators, and saturable transformers. Only Magnetic Precision Controls, Inc. is empowered to license the manufacture or sale of these inventions. Mr. Mamon has left the employ of this company and is no longer authorized to act in its behalf. M-2911, Electronics.

**WANTED**

**ANYTHING within reason that is wanted in the field served by Electronics can be quickly located through bringing it to the attention of thousands of men whose interest is assured because this is the business paper they read.**

**TUBES NEW! GUARANTEED!**

LOWEST OPEN MARKET QUOTES!

**BROADCAST TUBES**

2C39A	\$11.00	813	\$10.50
2H21	60.00	814	2.50
4X150A	21.50	815	1.50
4X150G	16.00	828	9.00
4-65A	18.00	829B	8.50
4-125A	18.00	836	2.25
4-250A	25.00	838	1.00
4-400A	50.00	843	.50
6A2	.80	845	5.00
100TH	6.00	849	17.50
203A	2.50	851	15.00
250TL	15.00	852	4.00
250TH	24.00	858	275.00
450TH	40.00	860	3.00
450TL	35.00	866A	1.45
508	275.00	872A	1.15
575A	10.00	880	250.00
HK-654	17.50	889RA	100.00
750TL	39.95	1500T	7.50
807	125.00	1603	7.45
810	10.00	1611	2.50
	5763		1.15

**THYRATONS**

CIK	\$5.75	FG-32	\$ 3.75
1C	1.00	FG-105	10.00
2D21W	1.20	FG-154	15.00
3B22	1.20	FG-172	19.95
3C45	7.00	FG-271	37.50
4E5	8.00	KU-627	10.00
CS6	1.00	MU-627	30.00
EL5B	7.00	2050	1.00
5C22	26.00	2050W	2.00
C6W/5528	7.00	2051	1.00
	5528/C6L		10.00

**5,000 SERIES & UP**

5517	\$1.60	5799A	POR
5528/C6L	10.00	5814	5.75
5559	12.00	5814WA	2.25
5586	125.00	5829	3.00
5588	125.00	5840	2.00
5607	250.00	5844	2.00
5610	1.60	5851	4.00
5611	48.00	5854	4.00
5632	1.50	5856	11.00
5635	12.50	5896	5.50
5636	3.50	5896A	5.25
5637	3.50	5898	7.50
5641	6.00	5899	4.00
5644	7.50	5899A	7.00
5645	7.00	5844	4.75
5646	10.00	5902A	8.00
5647	5.00	5932	4.00
5648	.50	5937/1754	20.00
5654/GAKSW	5.00	5948/1907	65.00
6096	5.00	5965	1.00
5657	125.00	5967	10.00
5663	1.25	5969	10.00
5670	1.10	5971	3.75
5670WA	4.50	5977A	5.50
5678	.90	5995	4.60
5680	115.00	5998	4.50
5681	2.00	6005	1.75
5691	4.75	6021	4.50
5693	4.75	6032	POR
5702	1.00	6044	30.00
5702WA	6.00	6045	1.75
5703	1.50	6080	4.75
5703WA	5.00	6096	2.50
5718	2.50	6098CT	5.50
5718A	4.85	6100	2.25
5719	1.75	6101/6J6WA	4.25
5719AS	5.00	6110	7.50
5722	4.00	6112	6.75
5725	2.00	6117	250.00
5725/GAS6W	4.00	6147	3.00
5726	.60	6152	POR
5726/GAL5W	3.00	6161	60.00
6097	3.50	6169	3.00
5732	3.50	6201	3.00
5742	2.50	6211	1.35
5749	1.30	6263	11.00
5750	1.75	6293	POR
5751	1.85	6328	POR
5762	125.00	6328	POR
5763	1.15	6381 Phot.	40.00
5780WE	3.00	6381	5.50
MAG	300.00	6382 Phot.	30.00
5783WB	5.50	9011	1.75
5784	4.00	8005	5.00
5784WA	7.50	8020/100R	7.50
5787	4.85	9002	85
5794	6.00	9003	1.35
5797	8.50	9006	.45

**RECTIFIERS & REGULATORS**

5B	\$2.00	5Y3WGT	\$1.90
5C	1.95	6-4	1.00
OB2	.65	6-11	1.00
OB3	.85	7H4B	1.00
OC2	.65	100P8020	7.50
OD3	1.00	100P8020	12.50
IV	.90	250R	2.00
2X2	1.75	314A	80.00
2X2A	1.00	371A	1.00
3B24	5.00	816	1.00
3B24W	5.00	866A	1.15
3B26	5.00	876	.75
3R4CY	4.00	878	.50
5Y3GT	.44		

**MAGNETRONS**

2J22	\$4.50	4J58	\$100.00
2J26	4.50	4J61	165.00
2J27	4.50	4J64	250.00
2J34	15.00	5J26	100.00
2J35	45.00	QK60	22.50
2J56	45.00	QK62	22.50
2J61	12.00	QK284	95.00
2J62	12.00	706CY	15.00
4J21	68.00	714A	10.00
4J26	45.00	725A	3.75
4J34	35.00	5586	150.00
4J42	35.00	5607A	150.00
4J50	80.00	5780	300.00

**SCOPE TUBES**

2AP1	\$4.00	5CP1A	\$7.50
3AP1	2.85	5CP1	8.00
3CP1	3.00	5FP7A	2.50
3DP7	6.00	5JP1	10.00
3DP1S2	15.00	5JP1A	25.00
3FP7	3.00	5JP1A	25.00
3CP1	1.95	5NP1	2.00
3FP1	7.50	60K60	4.99
3WZP1	50.00	7UP7	12.50
3EP1	1.25	9LP7	10.00
5BP1A	8.50	12DP7	12.00
5BP1	1.00	90ZP1	2.50

**COMPUTER TUBES**

2G21	\$2.00	5964	\$1.00
6AN5	2.25	5965, ETC.	1.00
	6211		1.35

**DIODES**

1N21C	\$12.00	1N32	\$8.00
1N23B	1.50	1N33	5.50
1N25	3.00	CK705	.40

**W. AND WA. TUBES**

6AC7W	\$2.00	6J4WA	\$3.50
6AC7WA	4.00	6SN7W	1.20
6AQ5WA	3.75	6SR7WGT	1.98
6AQ5W	.70	6SK7W	1.30
6AS6W	2.75	12AT7WA	3.00
6BF7	1.20	6X4W	4.99
6BF7W	1.25	6X5WGT	1.48
6J4	1.90	78W	2.00

**MISCELLANEOUS POWER TUBES**

2C42	\$9.00	VT-988R	POR
2C43	8.00	ML-322	\$10.00
2E6	6.00	RT-10	25.00
3E29	9.50	592A	18.50

**KLYSTRONS**

SRX-16	\$100.00	6BM6A	\$37.00
2K25	18.50	2K55	15.00
2K28	27.50	3F50	100.00
2K45	45.00	V-45	POR
2K48	80.00	V-50	POR
2K54	15.00	V-52	POR
6BL6	32.50	5611	48.00
6BM6	32.50	6116	250.00

**TR. AND ATR. TUBES**

1B27	\$10.00	1B58	\$42.00
1B35	1.25	Q22	70.00
1B35A	7.50	GA4	2.50
1B40	2.00	532A	1.00
1B63A	20.00	6232	60.00

All items F.O.B. Los Angeles, subject to prior sale and change of price without notice

**V & H RADIO and ELECTRONICS**

2029-2047 W VENICE BLVD. LOS ANGELES 6, CALIF. REpublic 5-0215

**A BARGAIN FOR YOU in a . . .**

**SO LA**

*Constant Voltage*  
**TRANSFORMER**

**End Fluctuating Line Voltage**

**OVER 60% OFF . . .**

the factory price of a 1-input 2,000 VA unit! And here's another bonus! This Air Force 2,000 VA overstock, Solo Cat. No. 30768, has 4 inputs! 90-125 V., 190-250 V., 60 cy. or 50 cy. Isolated secondary is constant 115.0 V. ± 1% from no-load to full-load of 17.4 amp. So, if you choose, use it as a 220-115 V. step-down. And slash \$147.50 off the factory 1-input price!



Brand new in original wood box. 4 cu. ft. Ship. wt. 254 lbs. F.O.B. Pasco, Wash. Only. **\$97.50**

(EXPORTERS: Note choice of 50 cycles.)  
**THE M. R. COMPANY**  
P. O. Box 1220-B Beverly Hills, Calif.





# INDEX TO ADVERTISERS

Ace Electronics Associates.....	374	Bird & Co., Inc., Richard H.....	402
Acme Wire Co.....	532	Bird Electronic Corp.....	445
Aeromark Company.....	444	Biley Electric Company.....	439
Adams & Westlake Co.....	58	Boehme, Inc., H. O.....	443
Adcola Products Ltd.....	400	Boesch Manufacturing Co., Inc.....	462
Adel Precision Products, a div of General Metals Corp.....	453	Boonton Electronics Corp.....	406
Aerojet-General Corp.....	236, 237	Boonton Radio Corp.....	385
Aeronautical Communications Equip- ment, Inc.....	31	Bristol Co.....	77
Aerovox Corp.....	289	Brush Electronics Company.....	81, 82, 83
Aircraft-Marin Products, Inc.....	143, 301	Budd-Stanley Co., Inc.....	252
Air Express Division, Railway Express Agency.....	251	Burnell & Co., Inc.....	253
Airpax Products Co.....	71	Burrhoughs Corp.....	74
Alden Products Co.....	373	Bussmann Mfg. Co.....	122
Allegheny Ludlum Steel Corp.....	88		
Allen-Bradley Co.....	343	Calidyne Company.....	330
Allied Radio Corp.....	465	Cambridge Thermionic Corp.....	80
Amco Engineering Company.....	464	Cannon Electric Co.....	440
American Airlines.....	36, 37	Carborundum Co., Global Division.....	361
American Gas Furnace Co.....	467	Carolina Power & Light Co.....	470
American Lava Corporation.....	247	Celco-Constantine Engineering Labora- tories Co.....	390, 430
American Machine & Foundry Co.....	357	Central Electronic Manufacturers, Inc.....	365
American Television & Radio Co.....	440	Centralab, A Division of Globe-Union, Inc.....	405
American Time Products, Inc.....	367	Century Electronics & Instruments, Inc.....	54
Amphenol Electronics Corp.....	242	Century Plating Co.....	527
Andrew Corporation.....	319	Chase Brass & Copper Co.....	91
Arnold Engineering Co.....	13	Chassis-Trak Corporation.....	443
Assembly Products, Inc.....	459	Chatham Electronics, Division of the Gera Corp.....	323
Associated Commodity Corp.....	470	Chicago Standard Transformer Corp.....	370 379
Associated Spring Corp.....	87	Chicago Telephone Supply Corp.....	73
Automatic Metal Products Corp.....	452	Christie Electric Corp.....	454
Automatic Mfg. Div. of General Instru- ment Corp.....	297	Cinch Mfg. Corp.....	225
Autonetics a Div. of North American Aviation.....	64	Circuit Instruments, Inc.....	409
		Clare & Co., C. P.....	111
		Clarostat Mfg. Co., Inc.....	267
B & K Manufacturing Co.....	411	Clearprint Paper Co.....	75
Bacon Industries, Inc.....	452	Cleveland Container Co.....	338
Bakelite Company A Division of Union Carbide & Carbon Company.....	139	Clifton Precision Products Co., Inc.....	147
Baker Chemical Co., J. T.....	351	Clough-Brengle Co.....	463
Baker & Co., Inc.....	449	Cohn Corp., Signund.....	418
Ballantine Laboratories, Inc.....	218	Collectron Corp.....	461
Barber-Colman Company.....	426	Communication Accessories Company.....	134
Barnstead Still & Demineralizer Co.....	388	Communication Measurements Labora- tory, Inc.....	430
Barry Controls, Inc.....	21	Computer-Measurements Corp.....	268
Bausch & Lomb Optical Co.....	401	Connecticut Hard Rubber Co.....	459
Beckman Instruments, Inc.....	458	Constantin & Co., L. L.....	146
Beede Electrical Instrument Co., Inc.....	468	Continental-Diamond Fibre Div. of the Budd Company, Inc.....	86
Bell Aircraft Corp.....	344	Cornell-Dubilier Electric Corp.....	317
Bell Telephone Laboratories.....	148	Cosmic Condenser Co.....	467
Bendix Aviation Corp., Red Bank Div.....	314	Coto-Coil Co., Inc.....	456
Bentley, Harris Mfg. Co.....	32	Crane Packing Company.....	433
Berkeley Div., Beckman Instruments, Inc.....	96		

# ESSEX

*Custom-Designs*

**ENCAPSULATED AND  
HERMETICALLY SEALED**

**DELAY LINES**

*to Your  
Specifications*

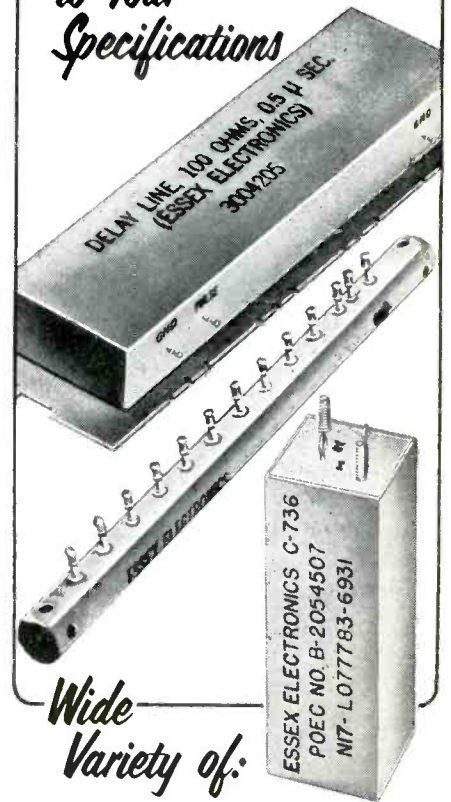

*Wide  
Variety of:*

**DISTRIBUTED CONSTANT  
DELAY LINES** designed for  
fast rise time and low at-  
tenuation made in flexible,  
metal-shielded and stick  
types.

**LUMPED CONSTANT  
DELAY LINES** feature high  
fidelity as well as compact  
size.

The name, Essex Electronics, is  
your reassurance of highest pos-  
sible product quality, efficiency,  
performance and satisfaction.

*Send specifications as detailed  
as possible for prompt cost  
quotations.*

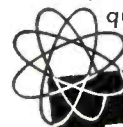

**ESSEX  
ELECTRONICS**

Exec. Off. & Main Plant.  
Berkeley Heights, New Jersey  
CRestview 3-9300

Other Plants at:  
7303 Atoll Ave., No. Hollywood, Calif.  
Trenton, Ontario—Canada

Want more information? Use post card on last page.

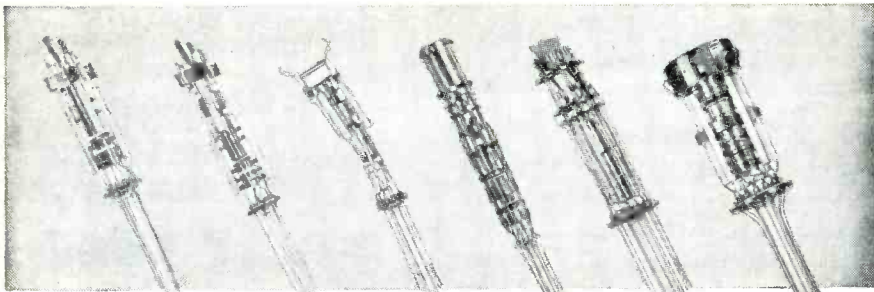

# Superior manufactures superior ELECTRONIC GUN MOUNTS!

For the CRT industry, SUPERIOR offers a full range of magnetic, electrostatic and color gun mounts . . . all precision engineered. You may order magnetic and electrostatic mounts with insulators of ceramic, pyrex cane or multiform glass. Electron guns for radar, and industrial tube types, custom built to your specifications.

Whether your order be large or small, you will enjoy all the benefits of our rigid inspection, testing and control. For complete satisfaction based on dependable service, call or write to

**SUPERIOR  ELECTRONICS**

CORPORATION

208-212 Piaget Ave. • GREGory 2-2500 • Clifton, N. J.

IF  
THIS IS YOUR  
**PROBLEM**

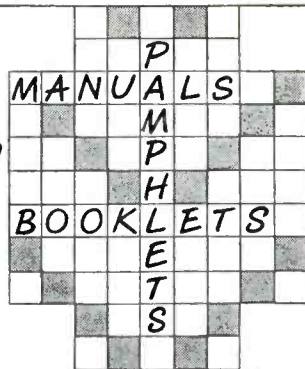

THIS IS YOUR  
**ANSWER**

The publications specialists of McGraw-Hill TECHNICAL WRITING SERVICE will write, edit, illustrate, design, and print your business literature for you. Save money and time in the production of Equipment Manuals, Product Bulletins, Handbooks, Company Histories, Annual Reports, and other such vital material. Let our staff be your staff for Technical and Business publications.

Write  
Technical Writing Service  
McGraw-Hill Book Co., Inc.  
330 W. 42nd St., N. Y. 36, N. Y.  
LONGacre 4-3000

This service is available through ad agencies.

Cross Co. H. . . . . 460  
Crucible Steel Company of America . . . . . 149  
Curtiss-Wright Corp. . . . . 246

Dale Products, Inc. . . . . 32B, 32C  
Danbury-Knuudsen, Inc. . . . . 384  
Dano Electric Co. . . . . 455  
Daven Company . . . . . 3rd Cover  
Davies Laboratories, Inc. . . . . 70  
Daystrom Pacific Corp., A Subsidiary of  
Daystrom, Inc. . . . . 368  
DeJur-Amsco Corporation . . . . . 302  
DeMornay-Bonardi . . . . . 444, 467  
Dialight Corporation . . . . . 413  
Douglas Aircraft Company, Inc. . . . . 309  
Dow Chemical Company . . . . . 311  
Dow Corning Corporation . . . . . 287  
Dumont Laboratories, Inc., Allen B. . . . . 255  
298  
Dunlee Corporation . . . . . 463  
Du Pont de Nemours & Co., (Inc.),  
E. I. Film Dept. . . . . 144, 145  
Polychemicals Dept. . . . . 257  
Driver Harriis Co. . . . . 333  
Durant Manufacturing Co. . . . . 278

Eastern Industries, Inc. . . . . 219  
Eastman Kodak Company . . . . . 259  
Edin Company, Inc. . . . . 264  
Eisler Engineering Co., Inc. . . . . 436  
Eitel-McCullough, Inc. . . . . 65  
Elco Corporation . . . . . 392  
Electrical Industries . . . . . 59  
Electric Indicator Company, Inc. . . . . 42  
Electro Instruments, Inc. . . . . 138  
Electro-Snap Switch & Mfg. Co. . . . . 103  
Electro Tec Corporation . . . . . 325  
Electronic Engineering Representatives . . . . . 327  
Electronic Instrument Co., Inc. (EICO) . . . . . 527  
Electronic Tube Corp. . . . . 378  
Electronics . . . . . 104, 105  
Elgin National Watch Co., Electronics  
Div. . . . . 308  
Empire Devices Products Corp. . . . . 414  
Engineering Co., The . . . . . 458  
Erie Electronics Division, Erie Resistor  
Corp. . . . . 420, 421  
Essex Electronics . . . . . 525

F-I Machine Works, Inc. . . . . 293  
Fairchild Controls Corp., Components  
Division . . . . . 97  
Fairchild Guided Missiles Div. . . . . 372

Ferroxcube Corp. of America.....	464
Film Capacitors, Inc. ....	529
Filtron Company, Inc. ....	50
Firestone Guided Missile Div.....	425
First Six .....	109
Fisher Radio Sales Co., Inc.....	454
Formica Corp., Subsidiary of American Cyanamid .....	345
Frenchtown Porcelain Co.....	457

Gabriel Electronics Div., Gabriel Co.....	306
Garrett Corporation.....	276, 277
Gates Radio Company.....	94
Gee-Lar Manufacturing Company.....	438
General Ceramics Corporation.....	337
General Electric Co. Apparatus Dept. ....	140, 141
Electronics Components Div.....	66, 67
Electronics Dept. ....	39
Laminated & Insulation Products Dept. ....	279
Metallurgical Products Dept.....	100
Specialty Electronic Components Dept.	23
Technical Personnel Dept.....	348
X-Ray Dept.....	428
General Findings & Supply Company.....	328
General Magnetics, Inc.....	530
General Mills, Mechanical Div.....	127
General Radio Co. ....	17
General Research & Supply Co.....	415
General Transistor Corp.....	331
Good-all Electric Mfg. Co.....	285
Grant Pulley & Hardware Corp.....	56
Greenleaf Manufacturing Co.....	29
Gries Reproducer Corp.....	431
Guardian Electric Mfg. Co.....	291
Gulton Industries, Inc. ....	349

Hamner Electronics Co., Inc.....	455
Handy & Harman .....	282
Harper Company, H. M.....	32D
Hart Manufacturing Co. ....	254
Harvey Hubbell, Inc.....	115
Hathaway Instrument, Division of Ham- ilton Watch Company .....	340
Haydon Mfg. Co., Inc.....	320
Heath Company .....	432
Heiland, a div. of Minneapolis-Honey- well .....	76
Helipot Corp., Div. of Beckman Instru- ments, Inc. ....	43
Henry Francis Parks Laboratory.....	470
Hewlett-Packard Company.....	62, 63, 116, 117
Heyman Manufacturing Co.....	460
Hickok Electrical Instrument Co.....	240
Hoffman Laboratories, Inc.....	231
Homelite, a division of Textron, Inc.....	300
Hoyt Electrical Instruments.....	455
Hughes Products, a div. of Hughes Air- craft Co. ....	107, 303

## REFLOWED SOLDER PLATING ON STRIP TERMINALS



CONTINUOUS HIGH SPEED  
PLATING OF STRIP MATERIAL

DETAIL PROCESS SPECIFICATION  
AVAILABLE ON REQUEST

ALL TYPES OF INDUSTRIAL SPECIFICATION PLATING

# Century Plating Co.

"ENGINEERING IN ELECTROPLATING"

229 FERRIS AVE., WHITE PLAINS, N. Y.

TELEPHONE: WHite Plains 8-3777



New!

# COLOR & BLACK & WHITE LAB & TV SERVICE 5" SCOPE

## 5 MC BANDWIDTH & DC AMPLIFIERS

- Flat from DC to 4.5 mc to reproduce 3.58 mc sync burst and oscillator signals in color TV sets.
- 4-step freq-compensated attenuator in both AC and DC positions.
- Built-in calibrator permits peak-to-peak voltage measurement.
- Automatically syncs anything visible on the screen.
- Pre-set TV V & H sweep positions (30 cps & 7875 cps).
- Edge-lit lucite engraved graph screen with dimmer control; filter; standard bezel fits standard photographic equipment.
- 5U1 CRT

# 460 **KIT**  
Factory Wired \$129.50 **\$79.95**

- V amplifier direct-coupled and push-pull thruout; gradual roll-off beyond 4.5 mc; useful at 10 mc.
- High V sensitivity: 25 mv/in.
- Choice of direct coupling (DC) or capacitive coupling (AC).



Write for FREE New 1956 Catalog E-10 and Name of Distributor

84 Withers Street • Brooklyn 11, N. Y.

©56 Prices 5% Higher on West Coast

NOW IN STOCK AT YOUR NEIGHBORHOOD DISTRIBUTOR . . . ORDER NOW!

Just Published

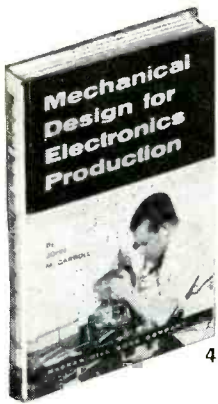

# MECHANICAL DESIGN IN ELECTRONICS PRODUCTION

By John M. CARROLL

Associate Editor Electronics

452 pages, 6 x 9 illustrated \$6.50

Gives engineers an understanding of the special problems of manufacturing devices using electron tubes and transistors, to aid in designing equipment that will combine best qualities of durability and economy. Gives information on a wide variety of processes and materials, including mechanical layout of equipment, sheet-metal work, machining operations, electric and magnetic shielding, resins and other sealing compounds, mechanisms, electric motors, mechanized assembly and packaging.

## RECENT MCGRAW-HILL BOOKS

### ELECTRONICS IN INDUSTRY

Just Published—Second Edition. Supplies the man who uses electronics equipment in plants with a thorough, nontechnical description of electronics circuits and equipment. Show how tubes and tube-operated circuits work in motor control, welding control, and other industrial applications. Explains a large number of commonly used industrial electron tube circuits. By George M. Chute, Univ. of Detroit. 2nd Ed., 440 pp., 344 illus., \$7.50

### MUSICAL ACOUSTICS

Just Published—Fourth Edition. A simple treatment, describing the physics of sound and the important phenomena of musical reproduction—in terms of the characteristics of various musical instruments, the human voice, recording and reproduction devices, and acoustics of rooms used for musical auditions. Musicians and both professional and amateur high-fidelity workers will find much to interest them in this authoritative but nonmathematical treatise. By Charles A. Culver, Carleton Coll. 4th Ed., 305 pp., 214 illus., \$6.00

### COMMUNICATION ENGINEERING

Just Published—Third Edition. Clear, step-by-step analyses of the major problems confronting the communications engineer. Emphasis in this edition is on the area which must precede the investigation of problems in all other divisions of communications—the fundamentals of linear-network analysis and synthesis. Develops both an analysis of various types of modulation and the transformation of transients from the time to the frequency domain. By W. L. Everitt and G. E. Anner, Univ. of Ill. 3rd Ed., 644 pp., 349 illus., \$9.00

### TRANSISTORS IN RADIO AND TELEVISION

Just Published. A simple, comprehensive guidebook for electronic technicians and radio and TV servicemen. Concisely presents facts about transistor circuits—their design, use, and maintenance. Takes you from a concise, sound explanation of modern electron theory to such subjects as point contact and junction transistors, transistor oscillators and amplifiers, transistor circuits, and servicing transistor circuits. By Milton S. Kiver, author of Color Television Fundamentals and other books on electronics. 322 pp., 238 illus., \$6.50

### FASTER, FASTER

A Simple Description of a Giant Electronic Calculator and the Problems It Solves

Explains in non-technical language how a calculator operates, the nature of the problems it solves, and how the problems are presented to the calculator. Describes "memory," tapes, printers, test and repair facilities, programming, etc. By W. J. Eckert and Rebecca Jones, Watson Scien. Computing Lab. 160 pp., 44 illus., \$3.75

### PULSE AND DIGITAL CIRCUITS

Just Published. Tested methods of working with all types of pulse and digital circuits, to help meet the engineering requirements of today's electronic equipment. Expert, down-to-earth guidance helps you analyze every circuit—shows how each is designed—how it functions—how it is best applied in modern electronic fields. Covers the full range of circuits used in such systems as analog and digital computers, radar, television, telemetering, etc. By Jacob Millman, Columbia Univ., and Herbert Taub, C. C. N. Y. 687 pp., 872 illus., \$12.50

Hughes Research & Development Laboratories	106
Humphrey, Inc.	352
Hunt Company, Philip A.	304
Hycon Eastern, Inc.	419
Hycon Electronics, Inc.	316
Hycon, Div. of International Resistance Co.	444

Ideal Industries, Inc.	284
Induction Motors Corp.	350
Industrial Timer Corp.	381
International Business Machine Corp.	339
International Electronic Research Corp.	52
International Resistance Company	136, 137
Irrington Div., Minnesota Mining & Manufacturing Co.	238

Jet Propulsion Laboratory	397
Johns Hopkins University, Applied Physics Laboratory	366
Johnson Company, E. F.	262
Jones Div., Howard B., Cinch Mfg. Co.	464
Jones Electronics Co., Inc., M. C.	380

Kahle Engineering Co.	15
Kay Electric Co.	31
Kay Lab	315
Kearfott Co., Inc.	382, 412
Kepeco Laboratories	229
Kester Solder Co.	273
Kinney Mfg. Division, New York Air Brake Company	295
Knights Company, James	51
Koch Fiberglass	426
Krengel Manufacturing Company	461
Kuthe Laboratories, Inc.	310

Lampkin Laboratories, Inc.	457
Lapp Insulator Co., Inc.	244
Leach Corporation	101
Librascope, Inc.	386
Linde Air Products Co., a Div. of Union Carbide & Carbon Corp.	40, 463
Lite Electric Company	461
Lockheed Missile System Div.	393
London Chemical Company, Inc.	466
Los Alamos Scientific Laboratory	239

## FREE EXAMINATION COUPON

McGraw-Hill Book Co., Dept. L-10, 327 W. 41st St., New York 36, N. Y. Send me book(s) checked below for 10 days' examination on approval. In 10 days I will remit for book(s) I keep, plus few cents for delivery costs, and return unwanted book(s) postpaid. (We pay delivery costs if you send remittance with this coupon; same return privilege.)

<input type="checkbox"/> Carroll—Mech. Design in Electronics Prod., \$6.50	(Print) Name .....
<input type="checkbox"/> Chute—Electronics in Industry, \$7.50	Address .....
<input type="checkbox"/> Culver—Musical Acoustics, \$6.00	City & Zone.....State.....
<input type="checkbox"/> Everitt & Anner—Communication Eng., \$9.00	Company .....
<input type="checkbox"/> Eckert & Jones—Faster, Faster, \$3.75	Position .....
<input type="checkbox"/> Kiver—Transistors in Radio & TV, \$6.50	
<input type="checkbox"/> Millman & Taub—Pulse and Digital Circs., \$12.50	

For price and terms outside U. S. write McGraw-Hill Intl., N. Y. C. L-10

M. B. Manufacturing Co., a Division Textron Inc. ....	290
MacLen Corp. ....	470
Magnafran, Inc. ....	432
Magnetic Amplifiers, Inc. ....	318
Magnetic Metals Company ....	437
Magnetics, Inc. ....	265
Maine Dept. of Development of Industry & Commerce ....	362
Malco Tool & Manufacturing Co. ....	448
Mallory and Co., Inc., P. R. ....	98, 150, 227
Marconi Instruments, Ltd. ....	135
Marion Electrical Instrument Co. ....	64A, 64B
Mark Products ....	465
Markem Machine Co. ....	468
Marshall Co., G. S. ....	41
Martin Company, Glenn L. ....	112, 113, 316
McCoy Electronics Company ....	376
McGraw-Hill Book Co. ....	528
Measurements Corporation ....	448
Mepeco, Inc. ....	47
Merit Plating Company ....	463
Metals & Controls Corp., General Plate Div. ....	387
Metal Textile Corp. ....	226
Micro Switch a Div. of Minneapolis- Honeywell Regulator Co. ....	55
Microwave Associates, Inc. ....	427
Midland Mfg. Co., Inc. ....	281
Milford Rivet & Machine Co. ....	467
Millen Mfg. Co., Inc., James ....	241
Minneapolis-Honeywell Regulator Co., Industrial Div. ....	72
Moloney Electric Co. ....	126
Monsanto Chemical Co. ....	133
Morris Company, J. I. ....	458
Moseley Co., F. L. ....	48
Multhead & Co., Ltd. ....	5
Mullard Overseas, Ltd. ....	118
Mycalex Corp. of America ....	321

N J E Corporation ....	46
National Lead Company ....	108
Natvar Corporation ....	423
Navigation Computer Corp. ....	303
Nems-Clarke, Inc. ....	450
New England Mica Co., Inc. ....	446
New York Coil Company ....	431
North American Aviation, Inc. ....	353
Northeastern Engineering ....	288
Nothelmer Winding Laboratories, Inc. ....	396
Northern Radio Co. ....	395

Oak Mfg. Co. ....	119
Oregon Electronics ....	429

**HIGHEST**  
**INSULATION RESISTANCE**  
and  
**CAPACITANCE STABILITY**

**LOWEST**  
**POWER FACTOR**  
and  
**SOAKAGE**

**fci**  
**POLYSTYRENE and TEFLON**  
**CAPACITORS**

**OPERATING TEMPERATURE**

up to 85°C. for Polystyrene  
up to 200°C. for Teflon

**AVAILABLE IN**

hermetically sealed glass tubes  
with metal end caps

style CP06 metal shells  
with glass-seal buttons

bathtub cases with low-loss  
glass terminals

style CP70 metal cans with  
low-loss glass terminals

**SPECIAL UNITS — INCLUDING MULTI-SECTION BLOCKS —  
AVAILABLE ON SPECIAL ORDER OR MADE TO SPECIFICATIONS**

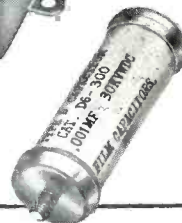

**ELECTRICAL CHARACTERISTICS**

	<b>POLYSTYRENE</b>	<b>TEFLON</b>
Operating Temp. Range.....	-55°C. to +85°C.	-55°C. to +200°C.
Voltage Range, DC.....	100 to 30,000	100 to 30,000
Capacitance Range.....	.001 to 20 mf	.001 to 20 mf
Power Factor.....	.02% @ 1 kc	.02% @ 1 kc
Dielectric Absorption.....	.01%	.01%
Voltage Derating at 85°C.....	none	none
Voltage Derating at 125°C.....	not operable	none
Voltage Derating at 150°C.....	not operable	none
Voltage Derating at 200°C.....	not operable	33%
Temperature Coefficient.....	-100 ppm/°C.	-50 ppm/°C.
I.R. at Room Temperature.....	10 <sup>7</sup> megohms/mf	10 <sup>7</sup> megohms/mf
Capacitance Stability.....	0.1%	0.1%

**fci film capacitors, inc.**

3400 Park Ave., New York 56, N.Y. • Phone CYpress 2-5180

# Since the choppers must fail, install a **MAGNETIC MODULATOR** for life

A Converter With High Shock and Vibration Resistance and Practically Unlimited Life. Operation in Ambient Temperatures From  $-70^{\circ}\text{C}$  to  $+150^{\circ}\text{C}$

**LOW LEVEL DUAL  
POLARITY DC SIGNALS**

CONVERTED TO

**PHASE REVERSING  
SUPPRESSED CARRIER  
MODULATED ENVELOPE**

**INPUT  
INFORMATION**

PHOTO CELL  
THERMOCOUPLE  
ANALOG DATA  
STRAIN GAUGE  
MAGNETROMETER  
MICROSEN  
LOW LEVEL DC  
VOLTAGE

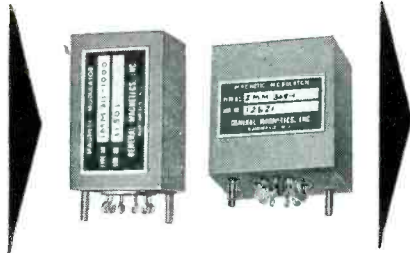

**OUTPUT  
INFORMATION**

SERVO AMPLIFIERS  
RECORDER  
MOTOR CONTROL  
SPEED CONTROL  
FLIGHT CONTROL  
FIRE CONTROL  
TEMPERATURE  
CONTROL  
AUTO POSITIONING  
VOLTAGE, CURRENT,  
FREQUENCY CONTROL

The magnetic Modulator is designed to convert low level dual polarity DC signals into AC signals of corresponding amplitude and phase sense.

We specialize in control systems and MAGNETIC AMPLIFIER components for automatic flight, fire control, analog computers, guided missiles, nuclear applications, antennas and gun turrets, commercial power amplifiers, and control systems.

PARAMETER	INPUT MODULATORS	
Type No.	IMM-336-1	IMM-311-1000
Excitation Frequency	360—440 CPS	360—440 CPS
Signal Winding DC Res.	9K $\pm$ 10%	1000 ohms
AC Excitation Volts	115V	5.0 Volts RMS
Input Signal Range	0— $\pm$ 70 $\mu$ A	0— $\pm$ 200 $\mu$ A
AC Output	0—8V RMS Phase Rev. 400 $\nu$	0—7V RMS 400 CPS Phase Rev.
Overall Dimensions	1" x 1 1/16" x 1 3/4"	1" x 1 1/16" x 1 3/4"
Null Amplitude	25mV RMS Maximum	30mV RMS Maximum
Output Impedance	20,000 ohms	20,000 ohms

PARAMETER	INPUT MODULATORS	
Response Curve		

PARAMETER	INPUT MODULATORS	THERMOCOUPLE CONVERTERS
Type No.	IMM-369-1	MTC-336-10
Excitation Frequency	60 CPS	360—440 CPS
Signal Winding DC Res.	800 ohms $\pm$ 10%	10 ohms $\pm$ 10%
AC Excitation Volts	3V RMS	6 Volts RMS @ 400 CPS
Input Signal Range	0— $\pm$ 500 $\mu$ A	0— $\pm$ 20 Millivolts
AC Output	0—2.4V RMS Phase Rev.	0—7.5V RMS Phase Rev.
Overall Dimensions	1 3/4" x 1 3/8" x 1 3/4"	1" x 1 1/16" x 1 3/4"
Null Amplitude	20mV RMS Maximum	20 Millivolts
Output Impedance	5K ohms	20,000 ohms

PARAMETER	INPUT MODULATORS	THERMOCOUPLE CONVERTERS
Response Curve		

**GENERAL**  **MAGNETICS**  
135 BLOOMFIELD AVE. BLOOMFIELD, N. J.

Pacific Automation Products, Inc.	270
Panoramie Radio Products, Inc.	411
Penta Laboratories, Inc.	250
Permag Corp.	459
Peter Partition Corp.	431
Phalo Plasties Corp.	435
Phaotron Instrument & Electronic Co.	292
Phelps-Dodge Copper Products Corp., Inca Mfg. Div.	78, 79
Philadelphia Bronze & Brass Corp.	110
Philamon Laboratories, Inc.	25
Phileo Corporation	307
Photo-Crystals, Inc.	456
Photographic Products, Inc.	466
Pittsburgh Leetrodryer Co.	92
Polarad Electronics Corporation	60, 61, 261
Polymer Corporation of Penna.	416
Potter & Brumfield	44
Potter Company	398
Precision Capacitors, Inc.	463
Precision Meter Co., Inc.	466
Precision Paper Tube Company	260
Proceedings of the I. R. E.	383
Pyramid Electric Co.	359

K-B-M Division, Essex Wire Corp.	243
Radio Condenser Co.	90
Radio Corporation of America	53, 131, 245, 329, 4th Cover
Radio Engineering Laboratories, Inc.	89
Radio Engineering Products	449
Radio Industries, Inc.	451
Radio Materials Corp.	299
Radio Receptor Co., Inc.	363
Ramo-Wooldridge Corp.	275
Rawson Electrical Instrument Co.	415
Raytheon Mfg. Company	19, 35, 57, 375
Reeves Instrument Corp.	33
Relay Sales, Inc.	125
Remington Rand Univac Div. of Sperry Rand Corp.	391
Rex Rheostat Co.	470
Richards Electrocraft, Inc.	526
Richardson Company	130

S W Electronics, a div. of Stewart-Warner Corp.	27
Sams & Co., Inc., Howard W.	415
Sanders Associates, Inc.	280
Schweber Electronics	461
Semimetals, Inc.	415
Shallcross Mfg. Co.	364
Shielding, Inc.	417
Sierra Electronic Corp.	442
Sigma Instruments, Inc.	354

Simpson Electric Company	128
Sola Electric Co.	114
Sonex, Inc.	459
Sorensen & Co., Inc.	4
Southco Div., South Chester Corp.	132
Southern Electronic Corp.	269
Southwestern Industrial Electronics Co.	256
Spectrol Electronics Div. of Carrier Corp.	336
Sprague Electric Co.	11, 233
Stackpole Carbon Co.	95
Staedtler, Inc., J. S.	416, 447
Standard Electric Time Co.	68, 69
Sterling Transformer Corp.	467
Stevens Arnold, Inc.	418
Stewart Corp., F. W.	452
Stoddart Aircraft Radio Co., Inc.	258, 470
Stromberg-Carlson Company	234, 377
Stupakoff, Div. of the Carborundum Company	84
Sun Tube Corporation	360
Superior Electric Company	85
Superior Electronics Corp.	526
Superior Tube Co.	313
Switchcraft, Inc.	459
Sylvania Electric Products, Inc.	6, 7, 124, 389
Syntronic Instruments, Inc.	445

Taylor Fibre Co.	38
Technicraft Laboratories, Inc.	334
Technology Instrument Corp.	404
Tektronix, Inc.	32A
Telechrome, Inc.	123
Tensolite Insulated Wire Co., Inc.	45
Texas Instruments Incorporated	235
Textile Banking Co., Inc.	296
Tower Construction Co.	129
Transitron Electronic Corp.	305
Transradio, Ltd.	450
Tung-Sol Electric, Inc.	341

Ucinite Co.	120
Union Switch & Signal Div. of Westinghouse Air Brake Company	286
United Air Lines	369
United-Carr Fastener Corp.	121
U. S. Engineering Co., Inc.	356
United States Gasket Co.	531
United States Radium Corp.	434
United Transformer Co.	2nd Cover
Universal Winding Co.	371
University of California Radiation Laboratory	271

cut  
assembly costs  
with  
U.S.G.-fabricated  
precision parts  
of



**TEFLON\***  
**KEL-F†**  
**BAKELITE**  
**Fluorothenes**  
**NYLON**

U.S.G. precision-molded or machined parts from the fluorocarbons and other plastics meet exacting specifications, assure uniform density and dimensional stability, uniform electrical, chemical and physical characteristics of the highest quality.

Strict quality control "from powder to part" and many years of experience in the particular technique of fabricating these unique plastic materials, assure cost-cutting results in your production line.

Write for 20-page brochure "Inside U.S.G." which suggests how this organization can serve you. Or send us your blue prints for quotations.

**UNITED STATES GASKET COMPANY**

CAMDEN 1, NEW JERSEY



\* du Pont's trademark for its tetrafluoroethylene resin.  
† Kellogg's trademark for its trifluorochloroethylene resin.



**IN  
MILLIONS  
OF UNITS  
Everywhere**



**ACME  
UNIFORM  
COMPONENTS**

MAGNET WIRE  
COIL WINDINGS  
VARNISHED INSULATIONS  
INSULATING VARNISHES  
COMPOUNDS

"Acme" stands for a half century of specialization in electrical insulations, with *uniformity* a first consideration.

Standardize on Acme-made components in your product and be 100% sure of a balanced assembly every time.

Submit us your product for a no-obligation analysis. Our engineers may be able to save you many dollars in its production. Our catalog should be in your *planning*. Let us send you one.



**ACME WIRE CO.**  
NEW HAVEN, CONN.

Want more information? Use post card on last page.

Varian Associates	93
Vector Electronics Co.	453
Veeder-Root, Inc.	335
Virginia Dept. of Conservation & Development	294
Virginia Electric & Power Co.	410
Vitramon Incorporated	49
Vulcan Electric Company	455

Waldes Kohinoor, Inc.	99
Ward Leonard Electric Co.	283
Waterman Products Co., Inc.	312
Waters Manufacturing, Inc.	332
Weldmatic a division of Unittek Corp.	108
Wenco Manufacturing Co.	454
Westinghouse Electric Corp.	102, 307, 355
Weston Electrical Instrument Corp. a subsidiary of Daystrom, Inc.	263
Wheeler Insulated Wire Co., Inc.	358
Wheeler Laboratories, Inc.	438
Whelock Signals, Inc.	428
White Dental Mfg. Co., S. S.	266, 436
White Instrument Laboratories	457
Wincharger Corp.	142
Worcester Pressed Steel Company	394

**MANUFACTURER'S REPRESENTATIVES** 470

**PROFESSIONAL SERVICES** 469

**CLASSIFIED ADVERTISING**  
F. J. Eberle, Business Mgr.

SEARCHLIGHT ADVERTISING	509-524
Aero Parts Supply	518
Allan Air Products Corp.	518
Alltronics	523
American College of Engineering	523
Arrow Sales Inc.	519
Barry Electronics Corp.	514
Bilan	514
C&H Sales Co.	513
Cap Electronics Inc.	518
Communication Devices Co., Inc.	516
Communications Equipment Co.	515
Dutchess Labs.	522
Empire Electronics Co.	518
Engineering Associates	522
Fair Radio Sales	516
Fay-Bill Distributing Co.	520
Finnegan, H.	523
Harjo Sales Co.	512
Instrument Service Co.	512
ISH Sales Co.	517
Lectronic Research Laboratories	522
Legri & Co.	512
Liberty Electronics Inc.	512
M. R. Co., The	523
McNeal Electric & Equipment Co.	514
Milano Brothers	518
Page Electronics	522
Radalab Inc.	520
Radio Research Instrument Co.	509
Relay Sales Inc.	516
Sanett, R. E.	523

Solo Electronics Sales Corp.	518
"TAB"	524
Tallen Co., Inc.	510-511
Textile Research Group	504
Trans-International Forwarders Inc.	523
Universal General Corp.	521
Van Breems, A.	509
V&H Radio Electronics Sply	523
Western Engineers	511
Wilgreen Industries	514

**EMPLOYMENT OPPORTUNITIES** 471-509

American Machine & Foundry Co.	482
Argonne National Laboratory	499
Arma Div., American Bosch Arma Corp.	498
	505, 508
Armour Research Foundation of Illinois Institute of Technology	502, 505
Avco Mfg. Corp., Crosley Div.	478
Avion Div., of ACF Industries	502
Bendix Aviation Corp.	
Pacific Division	475
Products Division	471, 479
Radio Division	493
York Division	506
Burroughs Corp., Research Center	495
Chatham Electronics	500
Collins Radio Co.	478
Convair, A Div. of General Dynamics Corp.	
Pomona, Calif.	484
San Diego, Calif.	477
Cornell Aeronautical Laboratory Inc.	489
Decision Inc.	504
Edwards Agencies	471
Farnsworth Electronics Co.	476
General Dynamics Corp., Electric Boat Div.	507
General Electric Co.	
Cincinnati, Ohio	486, 505
Idaho Falls, Idaho	486
Schenectady, N. Y.	500
Syracuse, N. Y.	507
Utica, N. Y.	502, 509
General Electronics Lab, Inc.	502
General Motors Corp.	
AC Electronics Div.	482, 487, 494
General Precision Laboratory Inc.	508
Goodyear Aircraft Corp.	
Akron, Ohio	481
Phoenix, Arizona	492
Goodyear Atomic Corp.	500
Honeywell Brown Instruments	506
Hoover Electronics Co.	501
Industrial Nucleonics Corp.	508
Industrial Research Labs.	476
Johns Hopkins University	490
Kollman Instrument Corp.	498
Magnavox Co.	508
Maryland Electronics Mfg. Corp.	480
Melpar Inc.	490
Missile Test Project	488
Monarch Personnel	508
Motorola, Inc.	480
National Cash Register Co.	474
Northeastern Engineering Inc.	500
Northrop Aircraft Inc.	486
Packard-Bell Co.	496
Page Communications Engineers Inc.	505
Philco Corp.	485
Philco Technical Representative Div.	494
Phillips Petroleum Co.	496
Putney, Mr.	506
Radio Corp. of America	472, 473
Raytheon Mfg. Co.	
Bedford, Mass.	483
Waltham, Mass.	491
Wayland, Mass.	496
Reeves Instrument Corp.	498
Stavid Engineering Inc.	484
Sylvania Electric Products Inc.	
Buffalo, N. Y.	492
Mountain View, Calif.	486
Waltham, Mass.	492, 506
Technical Career Consultants	506
Technical Research Group	504
Texas Instruments Inc.	475
Thompson Products Co.	504
Transition Electronic Corp.	488
Ultradyne Engineering Labs. Inc.	502
University of Michigan	490
Wall Street Journal	509
Westinghouse Electronic Tube Div.	497

This index is published as a service. Every care is taken to make it accurate, but ELECTRONICS assumes no responsibility for errors or omissions.



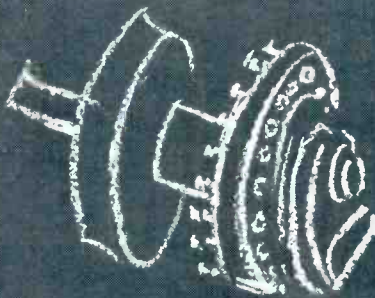
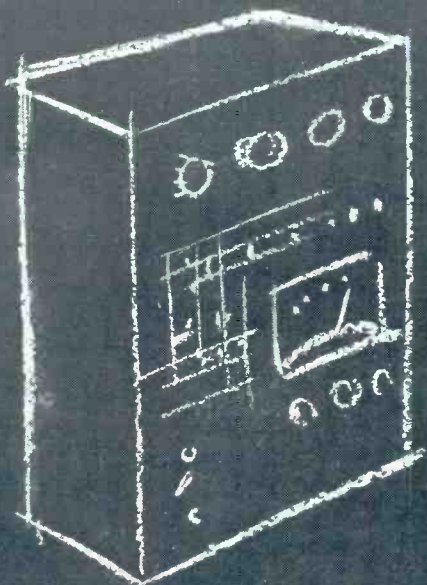

dependability, precise  
operation and  
unvarying performance



an engineering formula made famous by

## DAVEN PRECISION ROTARY STEP-TYPE SWITCHES



*This has been established as an engineering principle: for dependable, fool-proof switching in complex control equipment and instruments, more and more engineers are specifying DAVEN Precision Rotary Step-Type Switches.*

DAVEN switches, with their knee-action rotor and precious metal contacts, are

constructed to withstand continuous use over long periods of time under severest operating conditions.

Solutions to practically all rotary switch requirements . . . your requirements . . . can be found within the thousands of combinations of poles, positions and decks available in DAVEN'S complete line. When you specify a DAVEN rotary switch, you are specifying the finest.

ONLY DAVEN OFFERS THESE FEATURES:

- **Patented knee-action rotor**—assures low and uniform contact resistance and provides tamper-proof, trouble-free operation over the life of the switch.
- **One-piece combination contact and turret-type solder lug**—solid-silver alloy contacts, gold plated to resist corrosion. Turret design provides excellent electrical and mechanical connections.

• **Roller-type detent** gives positive indexing action.

• As many as **eight poles** available on each deck — important where minimum space is a factor.

Write for complete data, catalog and engineering information.

Today, more than ever,  
the DAVEN Ⓟ

stands for dependability!



THE **DAVEN** CO.

526 West Mt. Pleasant Avenue  
Route 10, Livingston, New Jersey

Another RCA first

# DRIFT

## TRANSISTOR

TYPE 2N247

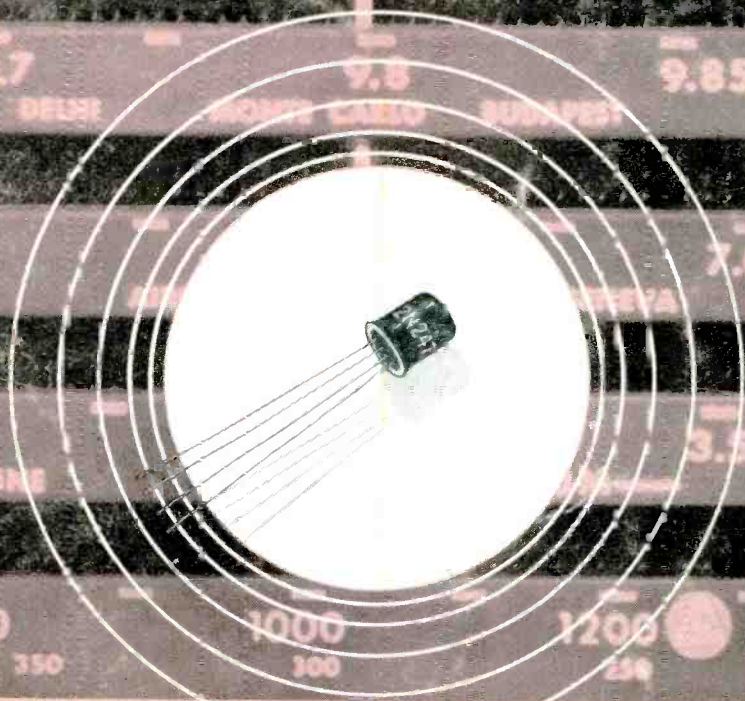

### New Concept in Transistor Design for High-Frequency Applications in Military and Commercial Equipment, and Entertainment-type Receivers

Designed to provide a "built-in" accelerating field in the base region that propels charge carriers from emitter to collector, RCA-2N247—a germanium p-n-p type transistor—begins a new era in transistor operation at radio frequencies extending from the Standard AM Broadcast band well up into the short-wave bands.

Here is a design that makes possible a significant reduction in base resistance and collector capacitance—substantially increases voltage- and current-handling capability, provides shielding between base and collector leads to minimize interlead capacitance and coupling to adjacent components. The resultant benefits to designers are: (1) high input circuit efficiency, (2) excellent operating stability, (3) good automatic-gain-control capabilities over wide input-signal variations, and (4) good signal-to-noise ratio.

In addition to its major application as a radio-frequency amplifier, RCA-2N247 is also well suited as a mixer-oscillator (converter) and intermediate-frequency amplifier in entertainment-type receivers.

Adaptable to mass-production techniques, RCA-2N247 can provide for the expanding needs of high-frequency commercial and military applications. It is one more example of RCA's intensive development program in semiconductor techniques to provide high-quality transistors—in quantity. For more data on Drift Transistor, Type-2N247 write RCA, Commercial Engineering. Or call your RCA Field Representative.

#### TYPICAL OPERATION AS CLASS A RF AMPLIFIER

Common-Emitter Circuit Base Input Ambient Temperature = 25°C

	1.5 Mc	10.7 Mc
DC Collector-to-Emitter Volts	-9	-9 volts
DC Base-to-Emitter Volts	-0.2	-0.2 volt
DC Collector Current	-1	-1 ma
Collector-to-Base Feedback Capacitance	1.7	1.7 $\mu$ f
Input Resistance	1350	170 ohms
Output Resistance	75000	4500 ohms
Power Gain <sup>▲</sup>	45	24 db

<sup>▲</sup>Measured in a single-tuned unilateralized circuit matched to the generator and load impedance for maximum transfer of power (transformer insertion losses not included).

#### RCA Field Offices

- EAST:** Humboldt 5-3900  
744 Broad Street  
Newark 2, N. J.
- MIDWEST:** Whitehall 4-2900  
Suite 1181,  
Merchandise Mart Plaza  
Chicago 54, Ill.
- WEST:** Raymond 3-8361  
6355 East Washington Blvd.  
Los Angeles 22, Calif.



**RADIO CORPORATION OF AMERICA**  
Semiconductor Division Somerville, N. J.